

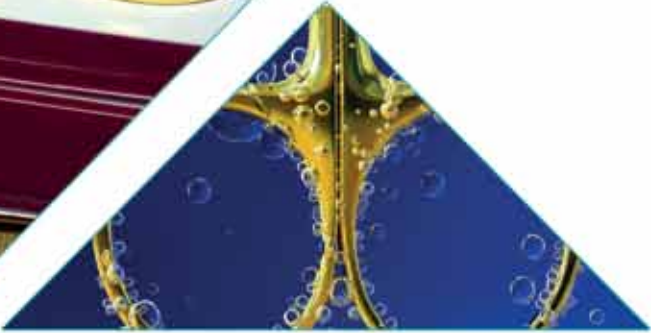

Genel Katalog
General Catalogue



EA	Muayene, Ölçme, Hazırlık ve Anestesi Aletleri Diagnostic, Measuring, preparation and Anaesthesia instruments	001-012
EB	Bıçaklar, Bistüri Sapları ve Dermatömler Knives, Scalpel Handles and Dermatomes	013-026
EC	Makaslar Scissors	027-096
ED	Pensetler Forceps	097-132
EE	Spanç, Doku ve Çamaşır Pensleri Sponge, Tissue and Washing Forceps	133-160
EF	Portegüler ve Sütür Aletleri Needle Holders and Suture Instruments	161-206
EG	Hemostatik Pensler, Diseksiyon Pensler, Histerektomi Pensleri Haemostatic Forceps, Dissecting Forceps, Hysterectomy Forceps	207-258
EH	Kalp Damar Cerrahi Cardiovascular and Thoracic Surgery	259-298
EJ	Sondalar, Aspiratör Uçları, Trokarlar ve Biyopsi İğneleri Probes, Suction Tubes, Trocars and Biopsy Needles	299-318
EK	El Ekartörleri, Huklar ve Spatulalar Retractors, Hooks and Spatulas	319-392
EL	Otomatik Ekartörleri Self-Retaining Retractors	393-436
EGC	Genel Cerrahi General Surgery	437-484
EUR	Ürolojik Aletler Genito-Urinary Instruments	485-506
EJN	Jinekolojik Aletler Gynaecological Instruments	507-576
EKR	Kalp ve Damar Cerrahi Cardiovascular and Thoracic Surgery	577-612
EM	Raspalar, Disektörler ve Elevatörler Raspatories, Dissectors and Levers	613-674
EN	Kemik Küretleri Bone Curettes	675-694

EP	Kemik Pensleri, Ronjurları, Makasları ve Pançları Bone Holding Forceps, Rongeurs, Scissors and Punches	695-730
ER	Ronjurlar Rongeurs	731-744
ENR	Beyin Cerrahi Neurosurgery	745-792
EOR	Ortopedik Cerrahi Orthopedic Surgery	793-828
EAN	Anatomi, Amputasyon ve Otopsi Aletleri Instruments For Anatomy, Amputation and Post Mortem	829-836
EDE	Dermatoloji Dermatology	837-842
EMR	Mikroskopi Microscopy	843-846
EEC	Elektrocerrahi Aletleri Electrosurgical Instruments	847-864
ETS	Taşlar, Böbrek Taşları Bowls, Kidney Trays	865-868
EA-EZ	Alfabetik İndeks Alphabetical Index	873-902
0-9	Sayısal İndeks Numerical Index	903-927

EA

Muayene, Ölçme, Hazırlık ve Anestesi Aletleri

Diagnostic, Measuring, Preparation and Anaesthesia Instruments





EK580-00
14.5 cm



EK580-01
14 cm

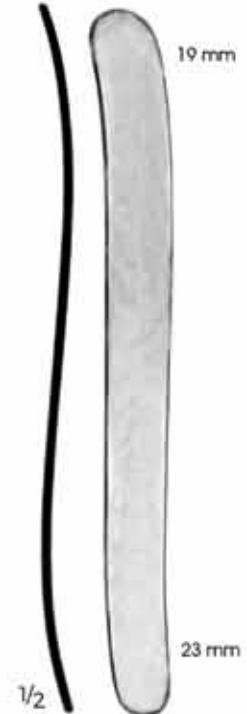

BUCHWALD
EK581-00
18 cm

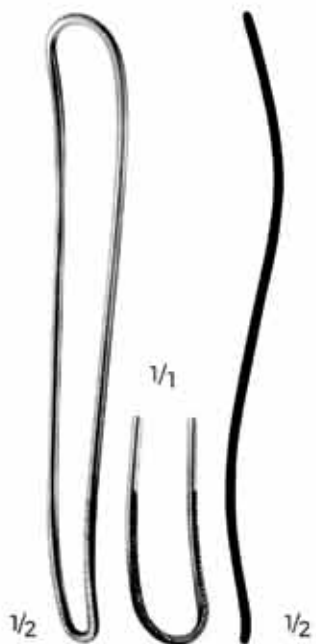

FRENZEL
EK585-00
16.5 cm



BRÜNINGS
EK583-00
19 cm



1/2

EL202-00
Ağız açıcı
Mouth gag
12.5 cm



1/2

**FERGUSON-ACKLAND
EL200-00**
Ağız açıcı
Mouth gag
14.5 cm



1/2

EL201-00
Ağız açıcı
Mouth gag
16 cm



1/2

**ROSER-KÖNIG
EL203-00**
Ağız açıcı
Mouth gag
18.5 cm



1/1

**SCHMID
EL199-00**
Ağız açıcı, ayarlanabilir
Mouth opening, adjustable



1/2

**HEISTER
EL206-00**
Ağız açıcı
Mouth gag
13 cm



1/2

ET100-00
Tahta ağız açıcı
Mouth gag wooden
14 cm

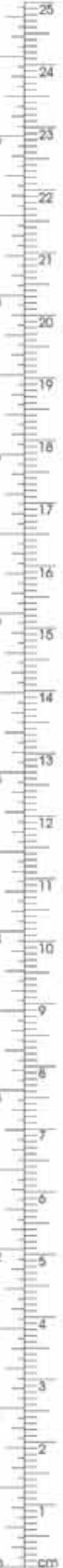

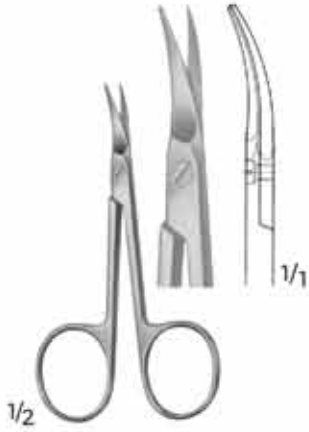

EC217-01
Tınak makası
Nail scissors
9 cm



EC217-00
Tınak makası, hassas
Nail scissors, delicate
9 cm

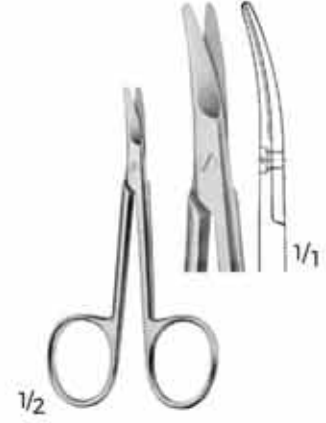

EC218-00
Bebek tınak makası
Baby nail scissors
8.5 cm



EC222-00
Düz/Straight



EC223-00
Eğri/Curved

EC222-00-EC223-00
Hassas makaslar
Delicate scissors
9 cm



EC216-00
Düz/Straight
9.5 cm



EC216-10
Eğri/Curved
9.5 cm



EC216-11
Eğri/Curved
10.5 cm

EC216-00
EC216-10-EC216-11
Tınak makasları
Nail Scissors



EC219-00-EC219-12
Tırnak makasları
Nail Scissors



EC219-00
Düz/Straight
9 cm



EC219-10
Eğri/Curved
9 cm



EC219-11
Eğri/Curved
10 cm



EC219-12
Eğri/Curved
11 cm



1/2

EP681-00
Tırnak makası
Nail cutter
13.5 cm



1/1



1/2

EP682-00
Tırnak makası
Nail cutter
14.5 cm



1/1



1/1

EN337-00
Tırnak törpüsü
Nail file
15 cm



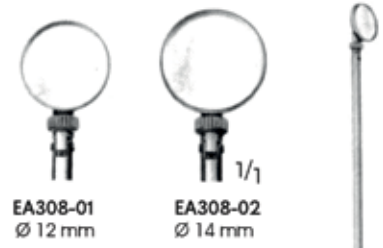
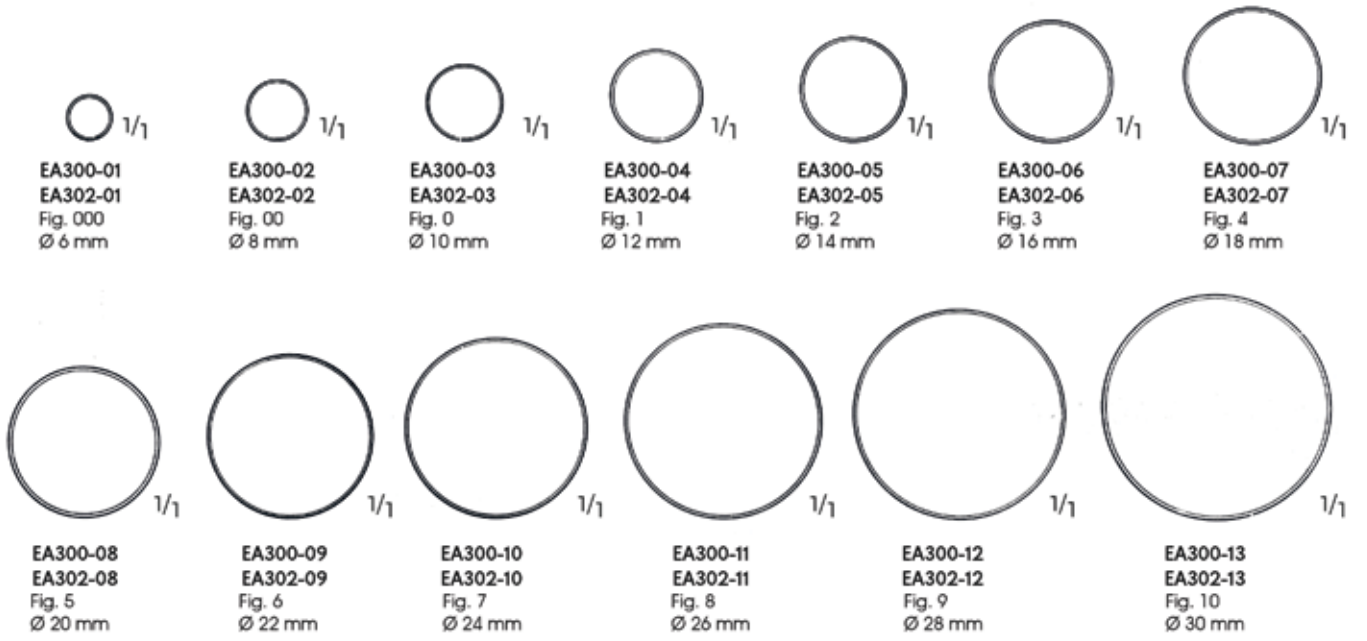



A 500.00-A 500.04
Cetveler/Rules

- AM500-00 10 cm
- AM500-01 15 cm
- AM500-02 20 cm
- AM500-03 30 cm
- AM500-04 50 cm



EM766-00
Meme markörü, dişli
Mamilla marker, toothed
Ø 33 mm



EM766-01
Meme markörü, dişli
Mamilla marker, toothed
Ø 38 mm



EM766-03
Meme markörü, dişli
Mamilla marker, toothed
Ø 42 mm



EM766-04
Meme markörü, dişli
Mamilla marker, toothed
Ø 48 mm



1/2

EA511-00
Nöroşirürji için özel kumpas
Caliper, special for neurosurgery
12.5 cm



1/3

EA510-00
Kumpas/Caliper
Ölçme 150 mm
Measuring 150 mm
23 cm



1/2

EA512-00
Kumpas/Caliper
Ölçme 100 mm
Measuring 100 mm
13 cm



1/2

EA523-00
Açı ölçer
Finger goniometer



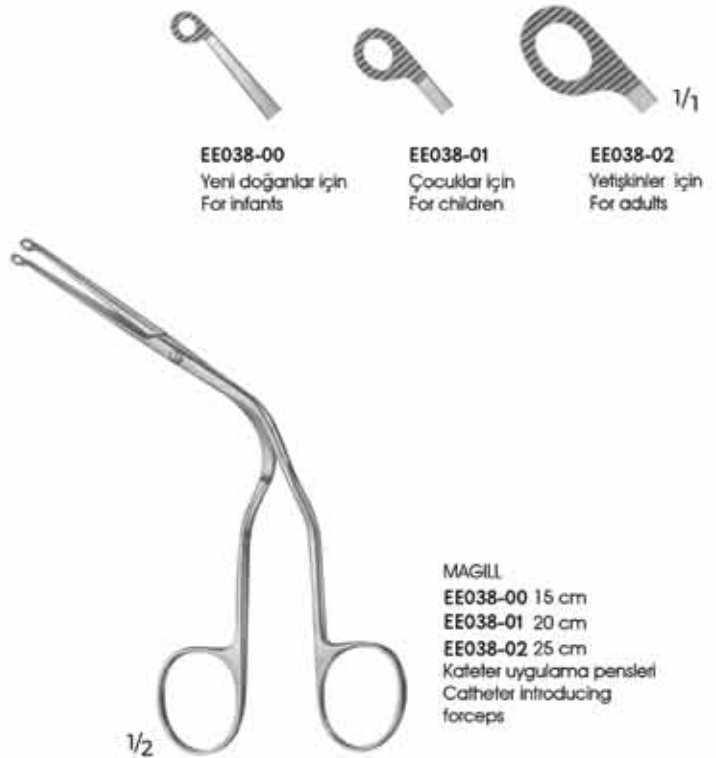
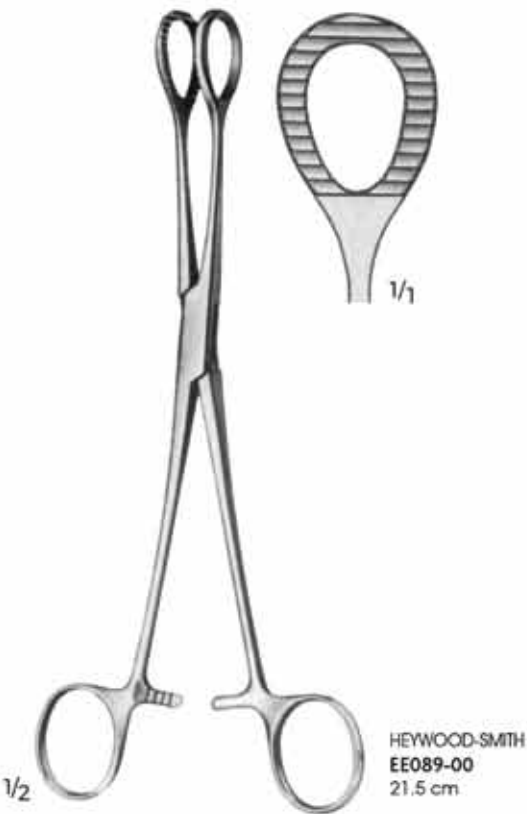
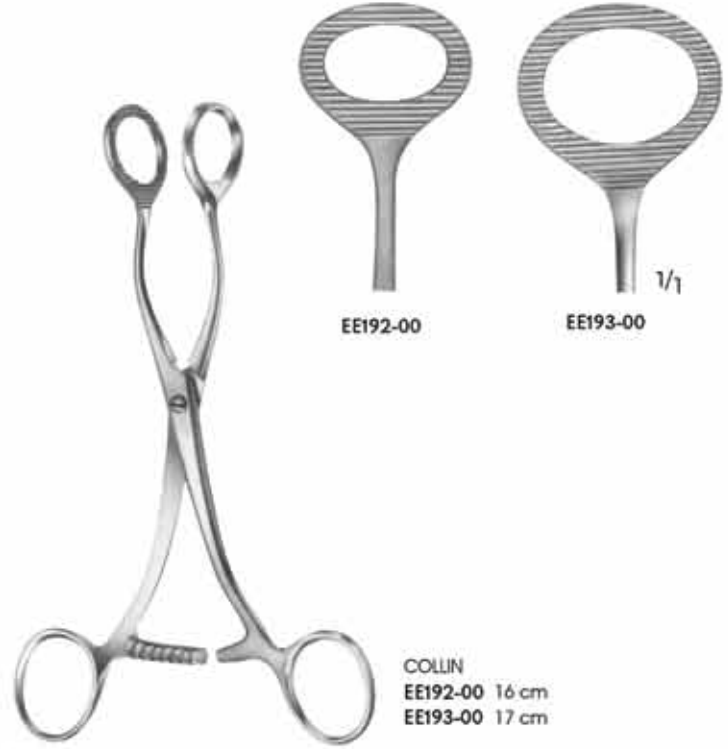
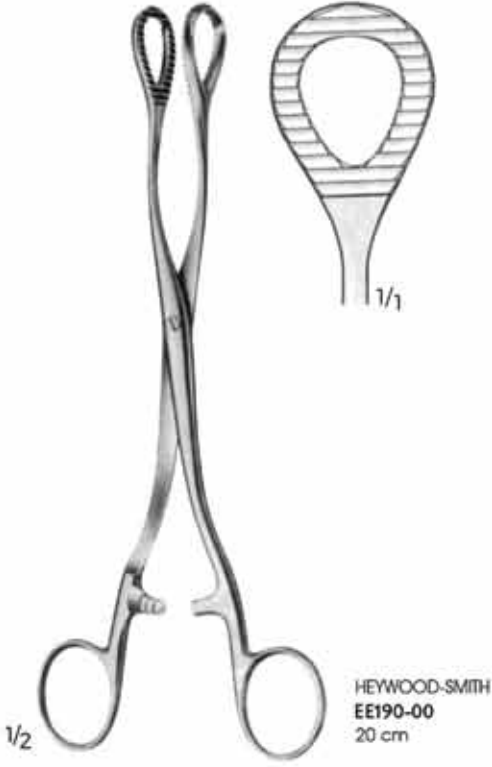

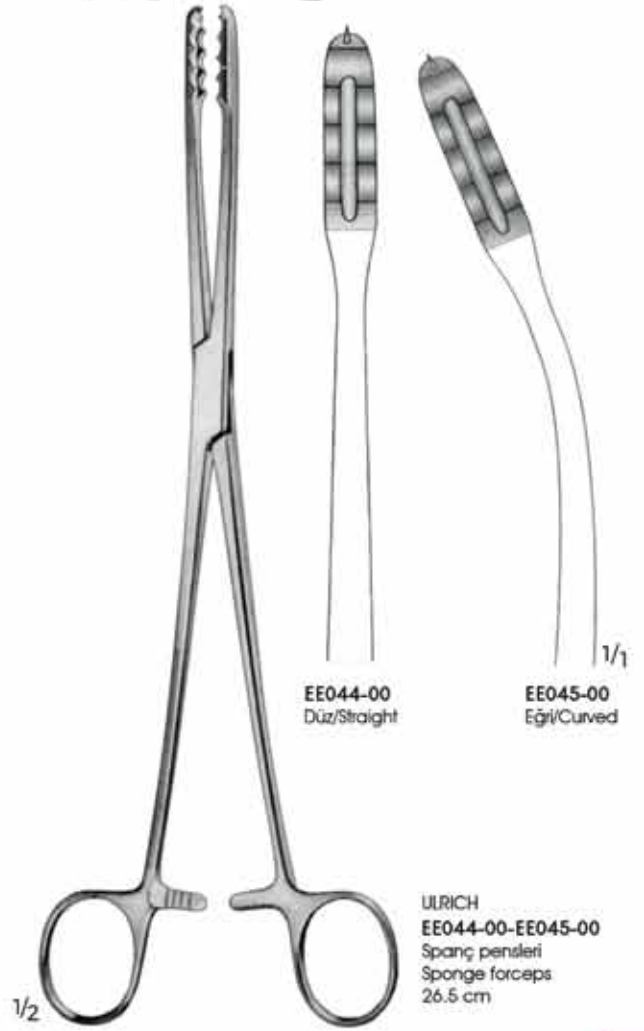
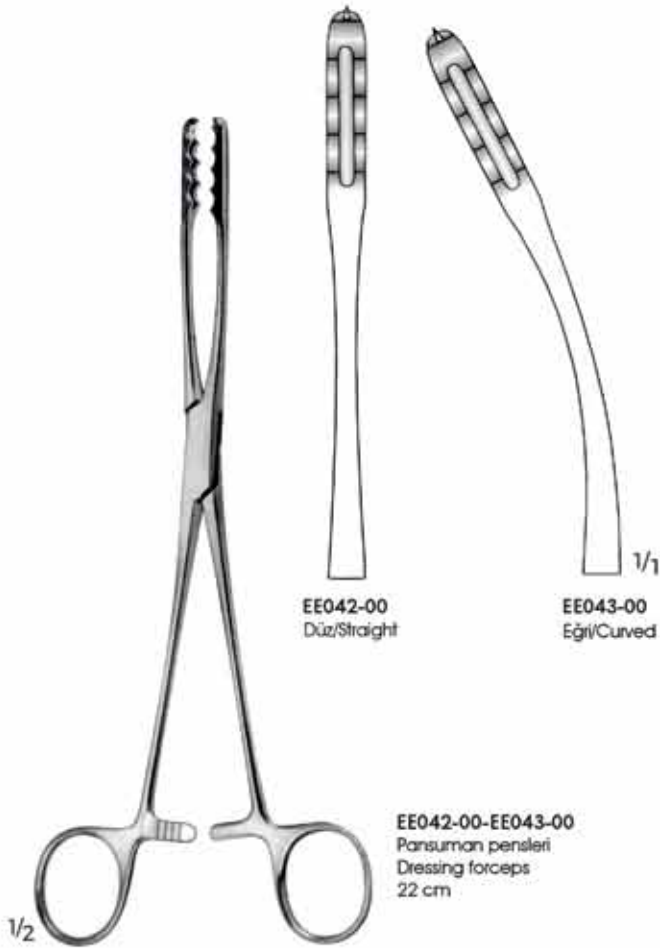
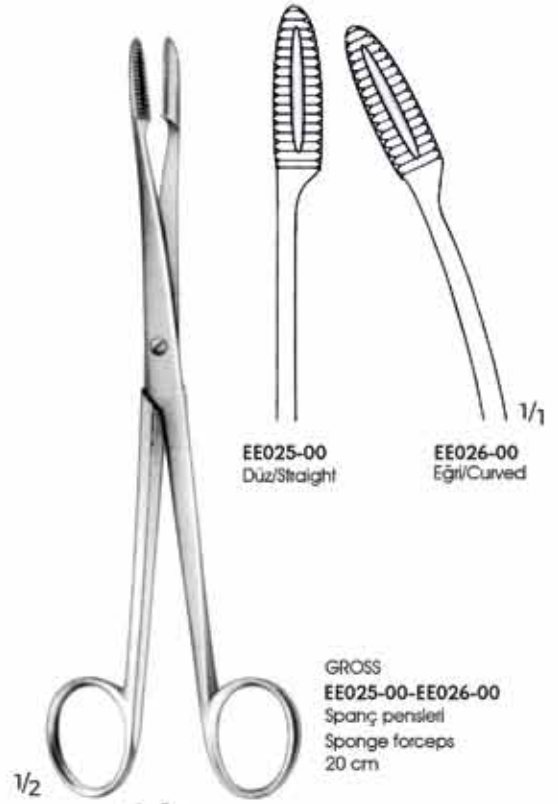
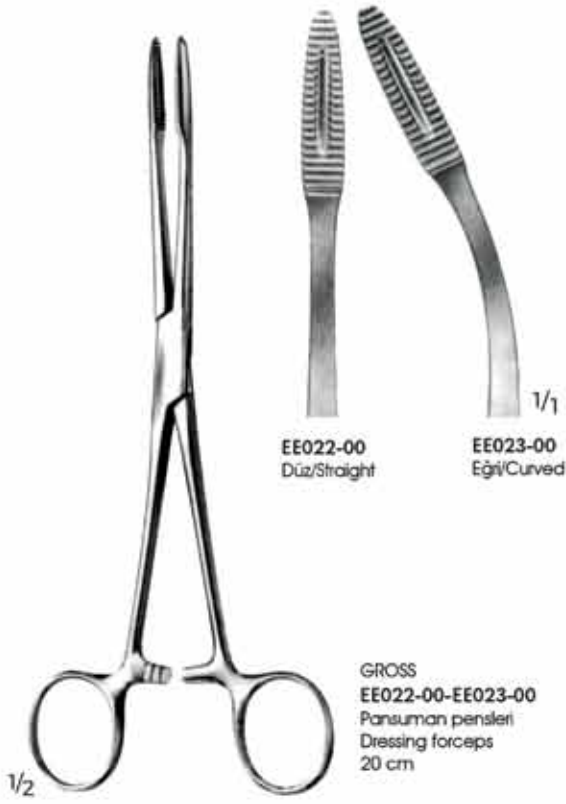



EG881-00
Tüp klempli, sert tüpler için
Tubing clamp forceps, heavy pattern
16.5 cm



EG885-00
Tüp klempli
Tubing clamp
18 cm



EG884-00-EG884-02
Tüp klempleri
Tubing clamps



EG784-00 15 cm
EG784-01 18 cm
EG784-03 19 cm
EG784-04 20 cm
Tüp klempleri
Tubing clamps

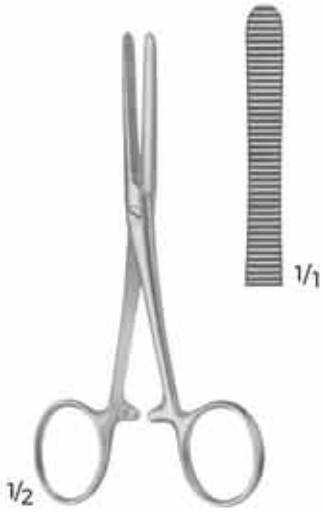

PEAN
EG400-00
Tüp klemp
Tubing clamp forceps
12.5 cm



KLINIKUM BERLIN
EG410-00
Uzun kilit mesafeli tüp klemp
Tubing clamp
heavy pattern, long ratchet,
therefore passage adjustable
14.5 cm



EG883-00
Sert tüpler için, tüp klemp
Tubing clamp forceps
16.5 cm



SAUERBRUCH
EG803-00
Tutma pens, tampon ve çamaşırlar için
Pick-up forceps for used tampons and
dressings
55 cm



EC
Makaslar
Scissors



1/1

EB104-00-EB104-05
13 cm



EB104-00



EB104-01



EB104-02



EB104-03



EB104-04



EB104-05

1/1



1/1

BERGMANN
EB106-006
14 cm



1/1



EB101-01-EB101-30



EB101-01
14 cm



EB101-031 15
cm



EB101-04
15.5 cm



EB101-06
16.5 cm



EB101-07 17
cm 1/1



EB101-08
17.5 cm



EB101-09 18
cm



EB101-26 18
cm



EB101-20 16
cm



EB101-30
Tenotom/Tenotome
17 cm 1/1





MASING
EB130-00 Eğri/sivri
Kıkırdak kesme bıçağı
Cartilage slitting knife,
curved blade, pointed
13 cm



JOSEPH
EB134-00 Düz/straight
EB135-00 Eğri/Curved
Çift taraflı burun bıçakları, sivri
Double-edged nasal knives pointed
14.5 cm



SIMON
EB118-00-EB118-02
Fistül bıçakları
Fistula knives
20 cm



ULRICH
EB110-01
Fistül bıçağı
Fistula knife
22.5 cm



EB111-02
Trigeminal bıçak
Trigeminal knife
23 cm

1/1



OLIVECRONA
EB124-00
Trigeminal bıçak
Trigeminal knife
20.5 cm

1/1



FOWLER
EB122-00
Tonsil bıçak
Tonsil knife
20 cm

1/1



ABRAHAM
EB125-00
Tonsil bıçak
Tonsil knife
21.5 cm

1/1

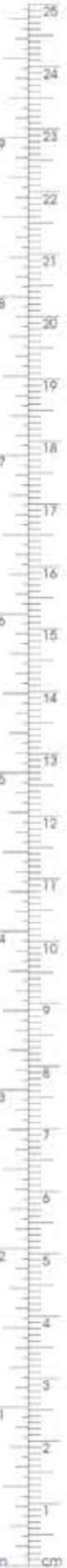

Çift taraflı kesme
Double cutting



EB141-00
Interosseöz bıçak
Interosseous knife
Ağız uzunlukları
Length of blade
11 cm

1/2

Çift taraflı kesme
Double cutting



LANGENBECK
EB143-00
Kanat bıçak
Flap knife
Ağız uzunlukları
Length of blade
12 cm

1/2

Çift taraflı kesme
Double cutting



LISTON
EB146-00 13 cm
EB146-01 16 cm
EB146-02 19 cm
EB146-03 22 cm
Amputasyon bıçakları
Amputation knives
Ağız uzunlukları
Length of blade
12 cm

1/2

Çift taraflı kesme
Double cutting



CATLIN
EB145-00
Amputasyon bıçak
Amputation knife
Ağız uzunlukları
Length of blade
16 cm

1/2



EB144-00
Falanks bıçak
Phalangeal knife
Ağız uzunlukları
Length of blade
10.5 cm



EB163-00
Periyost bıçak
Periosteum knife
Ağız uzunlukları
Length of blade
6.5 cm



LANGENBECK
EB160-00-EB161-00
Rezeksiyon bıçakları
Resection knives
Length of blade
Ağız uzunlukları
5.5 cm





1/2

SILVER
EB186-00P
Cilt nakil dermatomu, bıçaksız
Dermatome skin transplant,
bladeless
19 cm



1/2

REHN
EB180-00
23.5 cm



1/2

SCHINK
EB182-00
Sadece dermatom
Only dermatome
30 cm



EB188-01
Sadece yedek bıçak
Spare blade only



EB188-00
Sadece cilt düzeltme
plakası
Skin straightening plate only

SCHINK
EB182-01
Dermatom 0.1mm'den 2.0 mm kadar
ayarlanabilir, 1 adet değiştirilebilir B 188.01 ve
2 adet B 188.00 deri düzeltme plakası ile birlikte komple
Dermatome, adjustable from 0.1mm to 2.0 mm
complete, with 1 interchangeable blade and 2 skin straightening
plates
30 cm

Sabit bar
Bar fixed



**WATSON
EB184-00**

Cilt nakil dermatomu, bıçaksız
Volume transport dermatome,
bladeless
30 cm

Tirilli bar
Knurled bar



**COBBETT
EB187-00**

Cilt nakil dermatomu, bıçaksız
Volume transport dermatome,
bladeless
31.5 cm

Dönebilir, tirilli bar
Rotable toothed bar



**BRAITHWAITE
EB185-00**

Cilt nakil dermatomu, bıçaksız
Volume transport dermatome,
bladeless
31.5 cm



**HUMBY
EB190-00**

Cilt nakil dermatomu, bıçaksız
Volume transport dermatome,
bladeless
36.5 cm





EB040-00
No. 4
13.5 cm



EB040-01
No. 4
13.5 cm



EB030-00
No. 3
12.5 cm



EB030-01
No. 3
12.5 cm



EB033-00 No. 7
16 cm



BARRE
EB036-00-EB036-01
No. 3XL
Sol el için/For left hand
25 cm



EB036-00



EB036-01
1/1



BARRE
EB035-00
25 cm



1/1
EB045-00
No. 8
13 cm

1/1
EB046-00
No. 4
14.5 cm

1/1
EB030-02 No.
3 L
21 cm

1/1
EB040-02 No.
4 L
21.5 cm

1/1
EB034-00-EB034-01
No. 3
22.5 cm

EB043-00
No. 4
22.5 cm





LANDOLT
EB024-00
Bistüri sapı bayonet yuvarlak
saplı
Scalpel handle, bayonet-
shaped, round
25 cm



1/1

EB020-00
No. 3
21 cm



1/1

LANDOLT
EB022-00
Bistüri sapı bayonet
kare saplı
Scalpel handle,
bayonet- shaped square shank
21 cm



1/1



EC

Makaslar
Scissors

Düz Saplar ve çapraz tırtıl :
Sağlam kavrama özelliği sağlar.

Flat handles and cross serration:
Provides a solid grip.

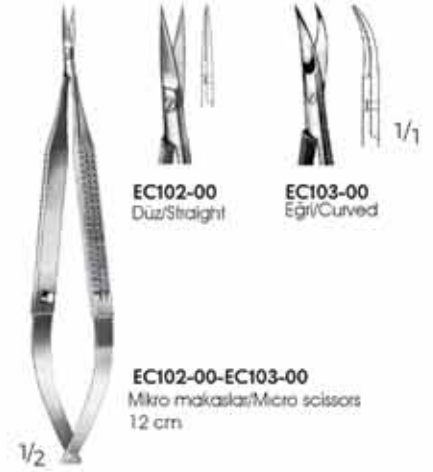
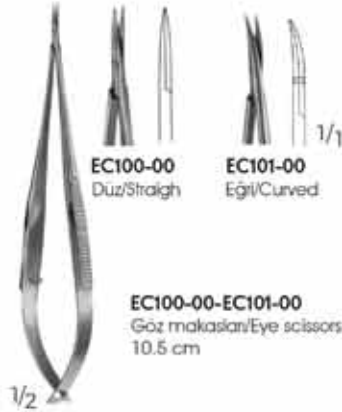
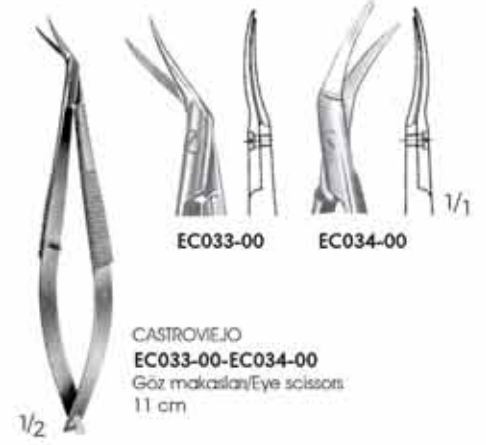
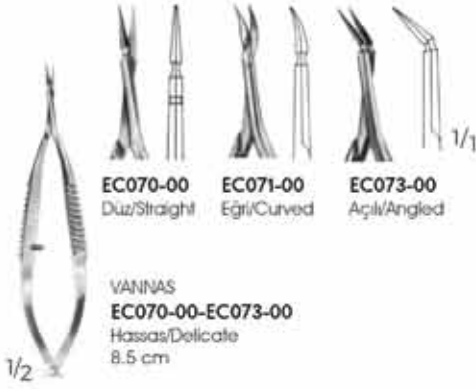

Kavrama yüzeyini artıran hafif plastik tutamak :

- Kramp oluşturmeyen, doğal tutma pozisyonu ve duyarlılık sağlar.
- Yuvarlak tutma kesiti aletin kolay ve düzgün rotasyonunu sağlar. Böylelikle uygulama ve çalışma alanı genişler.
- Pimli tutma profili güvenli tutmayı garanti eder.
- Ergonomik, hafif plastik sap yorulmadan optimum kullanım sağlar.

Lightweigh plastic handles to increase grip surface :

- Provides cramp free, natural holding positions and sensitivity
- Round cross-section of the instrument provides an easy and smooth rotation. Expands the working and application area.
- Retention profile with pin ensures safe gripping.
- Ergonomic, light weight plastic handle provides fatigue free, optimal usage.



Düz Saplar ve çapraz tırtıl :
Sağlam kavrama özelliği sağlar.

Flat handles and cross serration:
Provides a solid grip.



EC112-00
Düz/Straight



EC113-00
Eğil/Curved



1/1



EC116-00
Düz/Straight



EC117-00
Eğil/Curved



1/1



EC120-00
Düz/Straight



EC121-00
Eğil/Curved



1/1

1/2

EC112-00-EC113-00
16 cm

1/2

VANNAS
EC116-00-EC117-00
16 cm

1/2

MİLESI
EC120-00-EC121-00
Çift ağız tırtılı
Both jaws serrated
16 cm

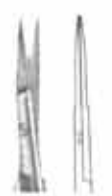

YASARGIL
EC124-00
Düz/Straight



JACOBSON
EC125-00
Eğil/Curved



1/1



EC168-08
Ultra hassas bıyıld
Ultra delicate blade



EC168-18
Hassas bıyıld
Delicate blade



1/1



EC168-09
Ultra hassas bıyıld
Ultra delicate blade



EC168-19
Hassas bıyıld
Delicate blade



1/1

1/2

EC124-00-EC125-00
18.5 cm

1/2

EC168-08-EC168-18
Düz/Straight
16.5 cm

1/2

EC168-09-EC168-19
Eğil/Curved
16.5 cm

Yuvarlak Saplar

- Parmaklar arasında istenildiği şekilde döndürmeye izin verir.
- Sağlam veya oyulmuş saplardan dolayı her bir alette optimum denge sağlar.

Round Handle

- Allows rotation between the fingers as required
- Due to carved and strong handle, each instrument provides optimum balance.

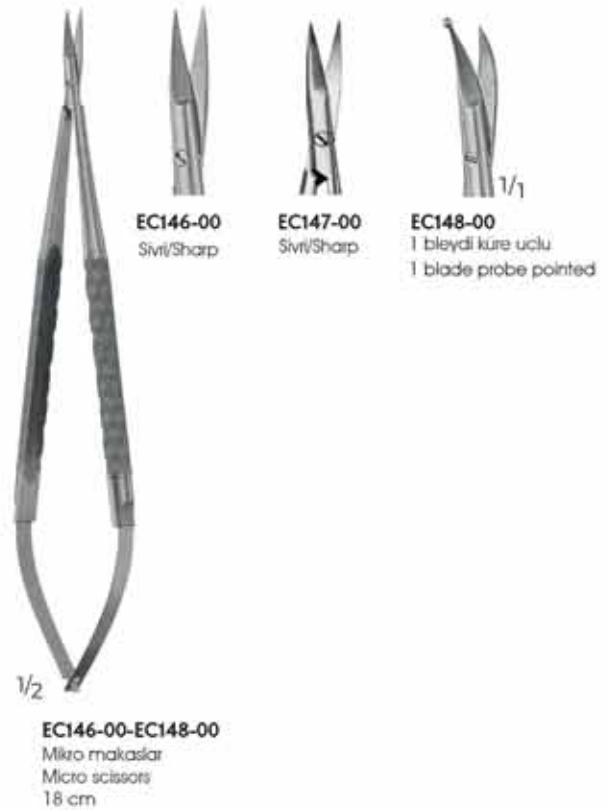
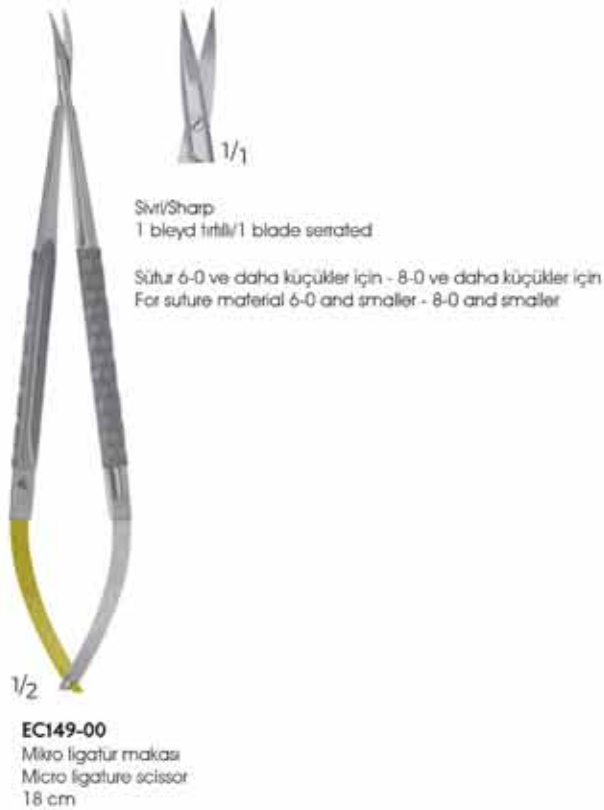
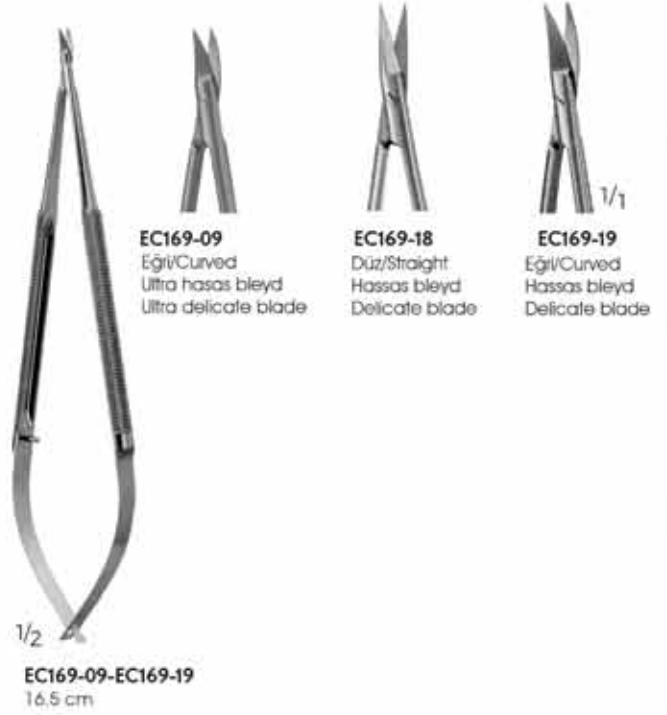
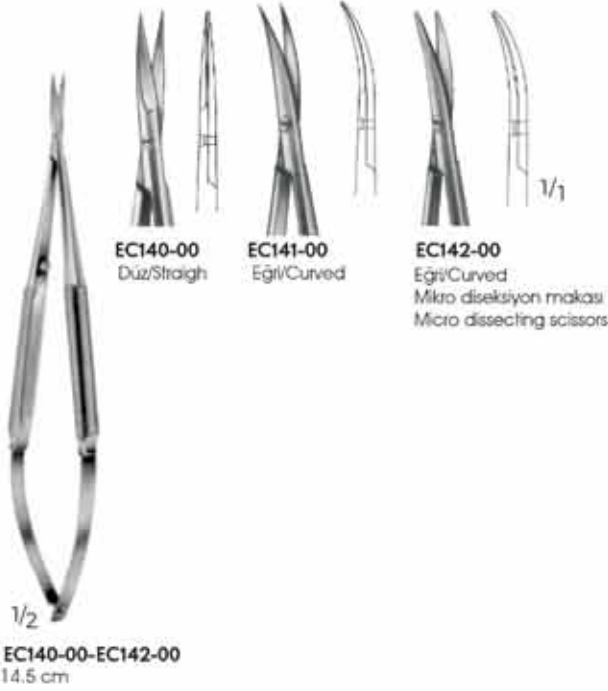

**Düz Sap
Flat Handle**

Ince Bleyd
Fine Blade

25°

45°

60°

90°

125°



EC168-50



EC168-51



EC168-53



EC168-54



EC168-56

Hassas Bleyd, tek tarafı küre uçlu bleyd
Delicate Blade, with 1 probe pointed blade



EC168-30



EC168-31



EC168-33



EC168-34



EC168-36

Hassas Bleyd
Delicate Blade



EC168-10



EC168-11



EC168-13



EC168-14



EC168-16

Ultra Hassas Bleyd
Ultra Delicate Blade



EC168-00



EC168-01



EC168-03



EC168-04



EC168-06



1/1

EC168-00-EC168-56
16.5 cm

**Yuvarlak Sap
Round Handle**

Ince Bleyd
Fine Blade

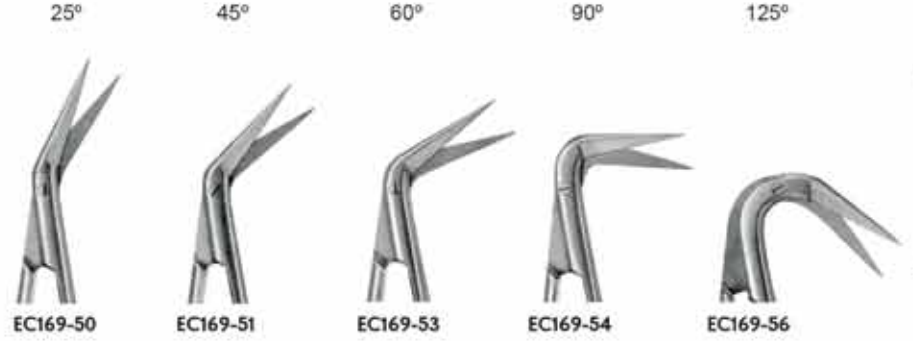

Hassas Bleyd, tek tarafı küre uçlu bleyd
Delicate Blade, with one probe pointed blade



Hassas Bleyd
Delicate Blade



Ultra Hassas Bleyd
Ultra Delicate Blade



1/1

EC169-00-EC169-56
16.5 cm



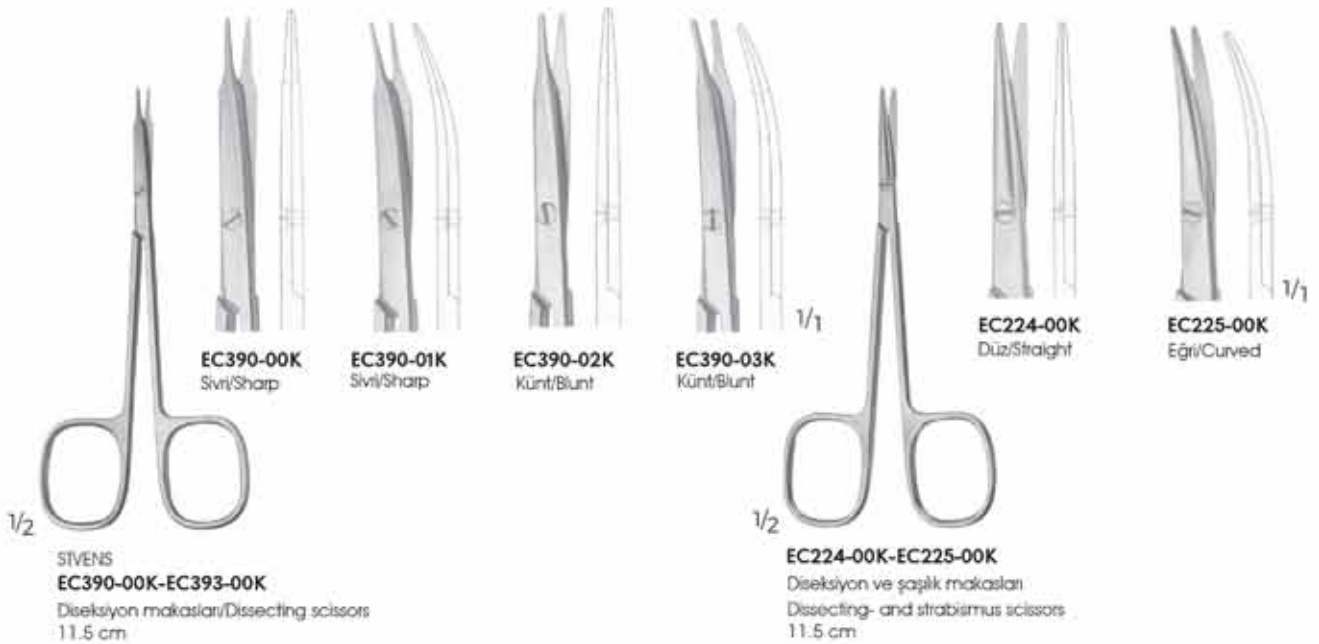
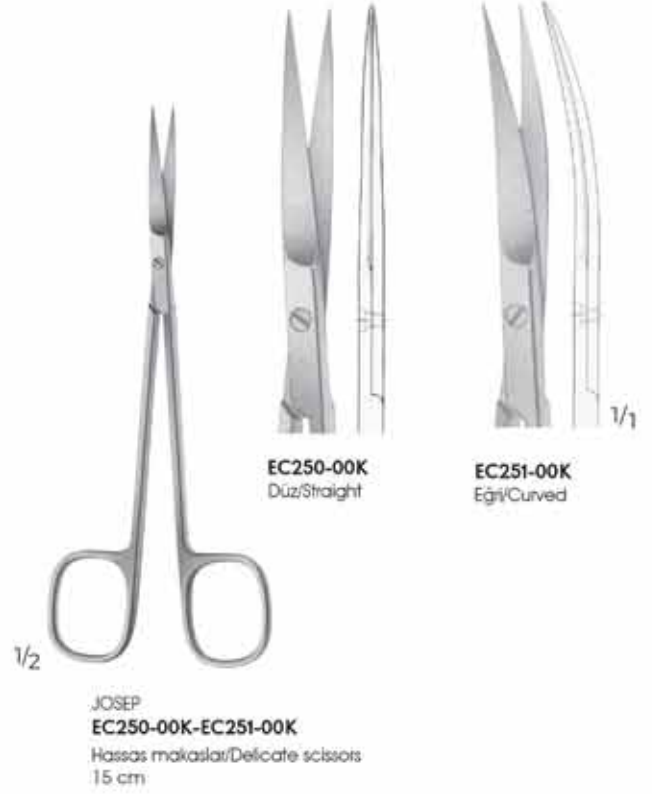

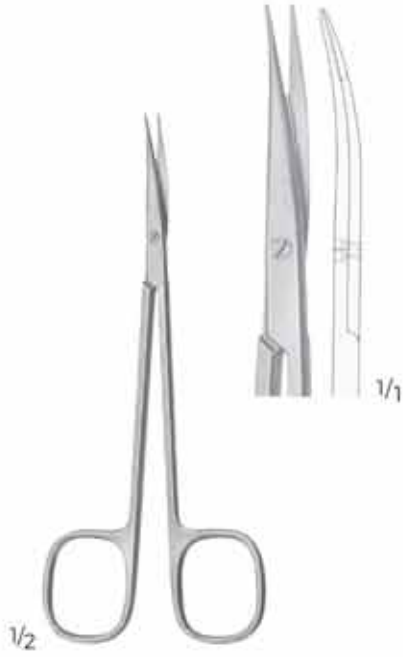

REYNOLDS-JAMESON
EC386-00K
Vasküler makas/Vascular scissors
14 cm



EC412-00K
Düz/Straight

METZENBAUM
EC412-00K-EC413-00K
Diseksiyon makasları/Dissecting scissors
14.5 cm

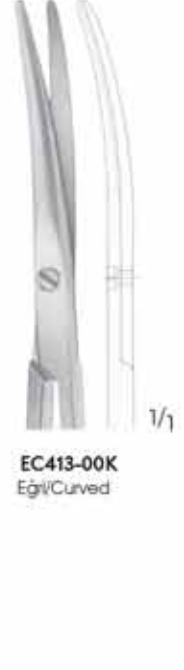

EC413-00K
Eğil/Curved



EC258-00K
Diseksiyon, sinir makası
Nerve dissecting scissors
14 cm



EC398-00K
Düz/Straight
13.5 cm

EC398-10K
Eğil/Curved
13.5 cm

EC398-11K
Eğil/Curved
15 cm

RAGNELL
EC398-00K-EC398-11K
Diseksiyon ve cilt altı için özel düz uçlar
Special flat points for dissecting and
undermining the skin





EC220-00-EC221-00
9 cm



EC220-00
Düz/Straight



EC221-00
Eğri/Curved



EC222-00-EC223-00
9.5 cm



EC222-00
Düz/Straight



EC223-00
Eğri/Curved



EC222-01-EC223-01
10.5 cm



EC222-01
Düz/Straight



EC223-01
Eğri/Curved



EC226-00-EC227-00
12 cm



EC226-00
Düz/Straight



EC227-00
Eğri/Curved





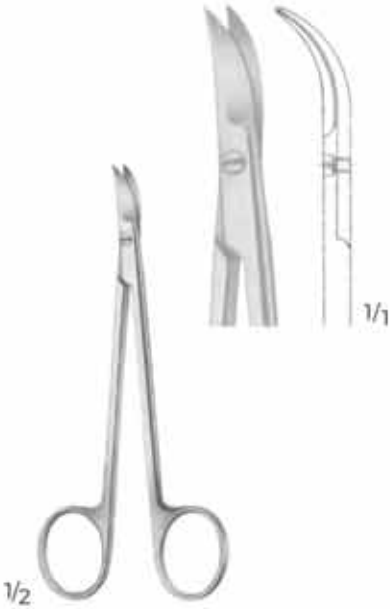

CHADWICK
EC260-00
11.6 cm

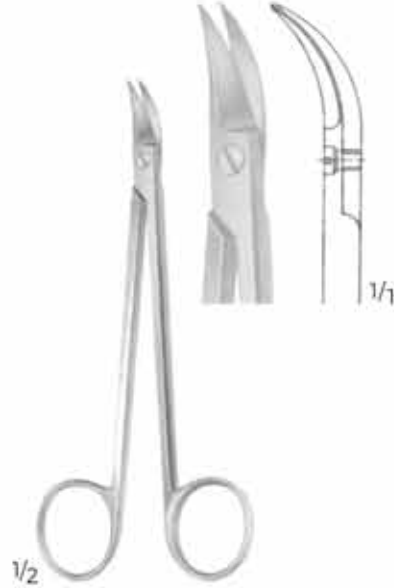

QUINBY
EC261-00
13 cm

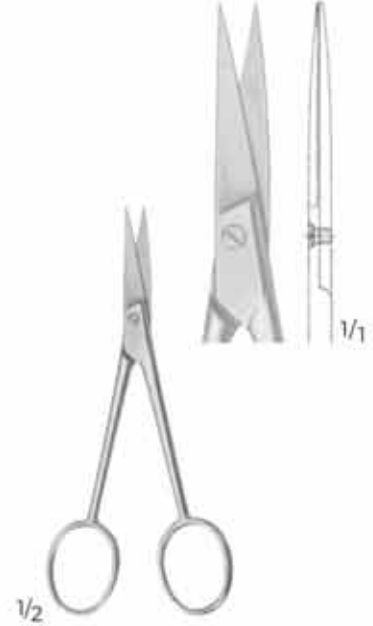

EC264-00
11 cm



PERWITZSCHKY
EC522-00
1 bıleydi kure uclu eğil.
With 1 probe pointed blade, curved to side
10 cm



EC523-00
Yana doğru açılı
Angled to side
11.5 cm

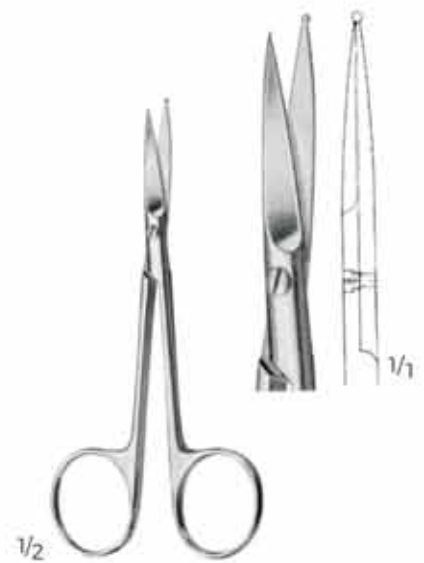

EC540-00
1 bıleydi kure uclu
With 1 probe pointed blade
12 cm





LA GRANGE
EC532-00
Tek ağız tırtılı
One jaw serrated
11 cm



EC533-00
Tek ağız tırtılı, yana açılı
Angled on flat, one jaw serrated
12.5 cm

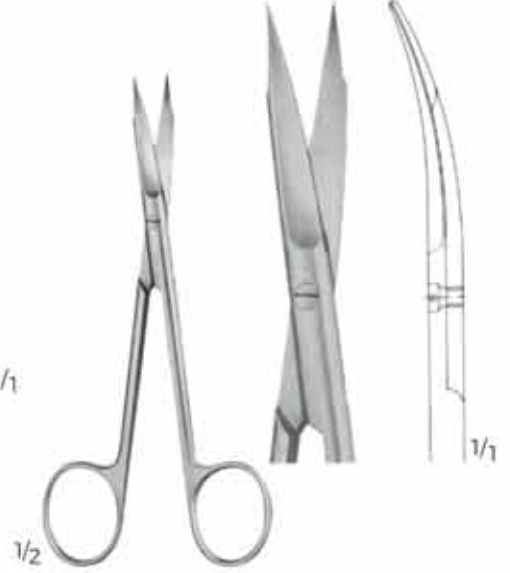

EC534-00
Tek ağız tırtılı, hassas
One jaw fine serrated
13 cm

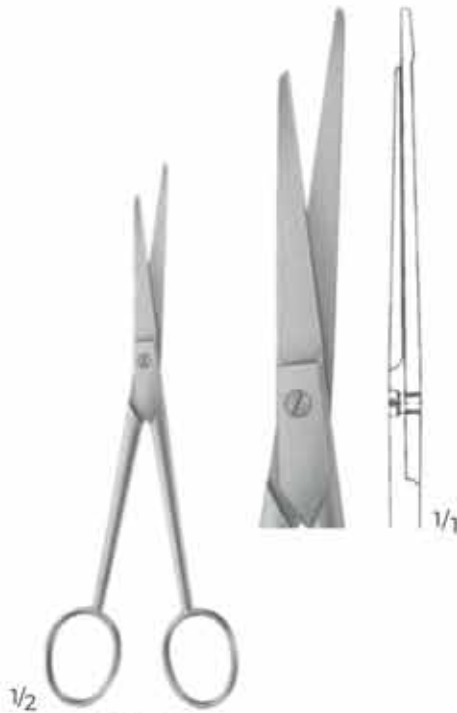

EC542-00
1 ucu problu
With 1 probe pointed blade
14.5 cm



LOCKLIN
EC546-00
Tek ağız tırtılı, yana açılı
Angled to side, one jaw serrated
15.5 cm

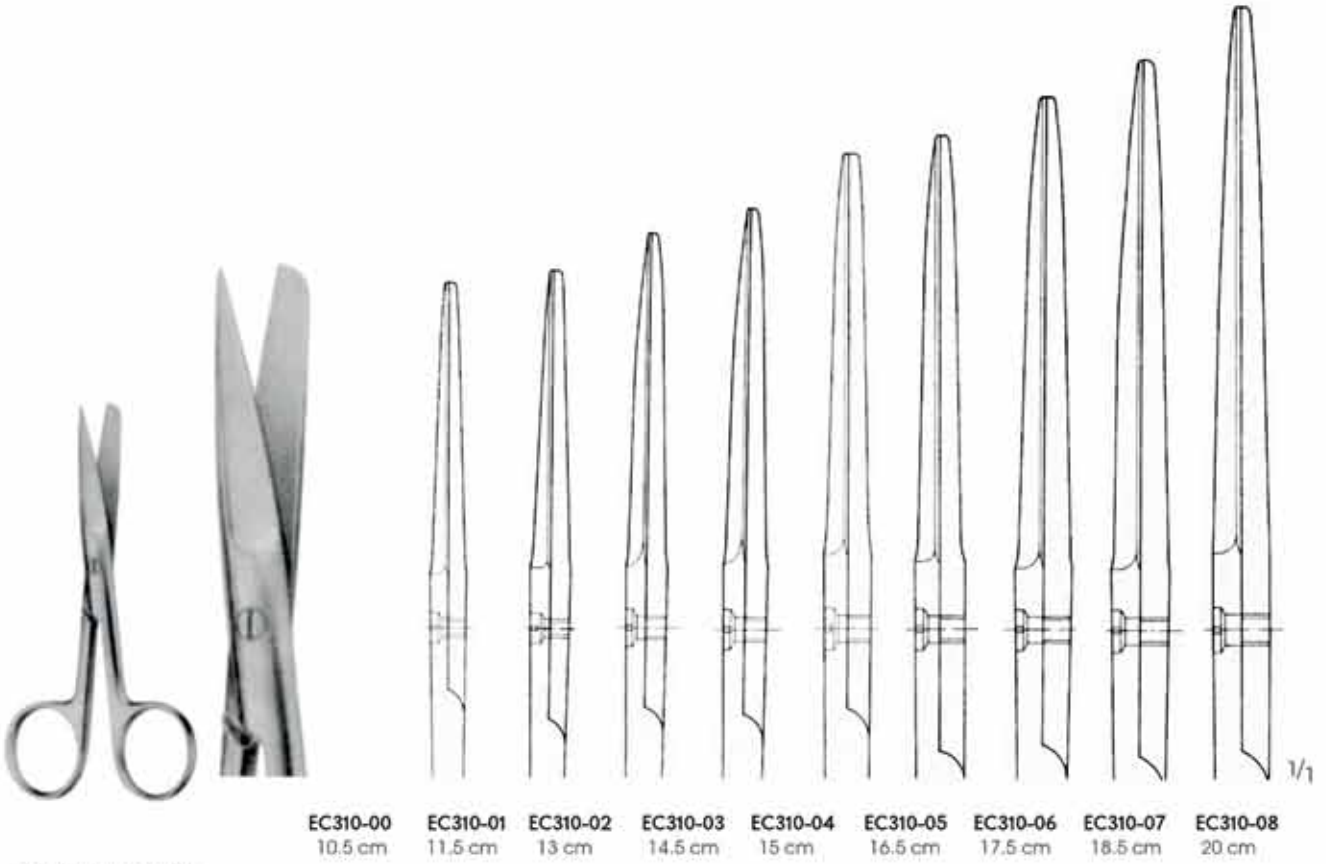

EC310-00-EC310-08

Standart model/Standart patterns
Sivli-Künlü/Sharp-Blunt
Düz/Straight

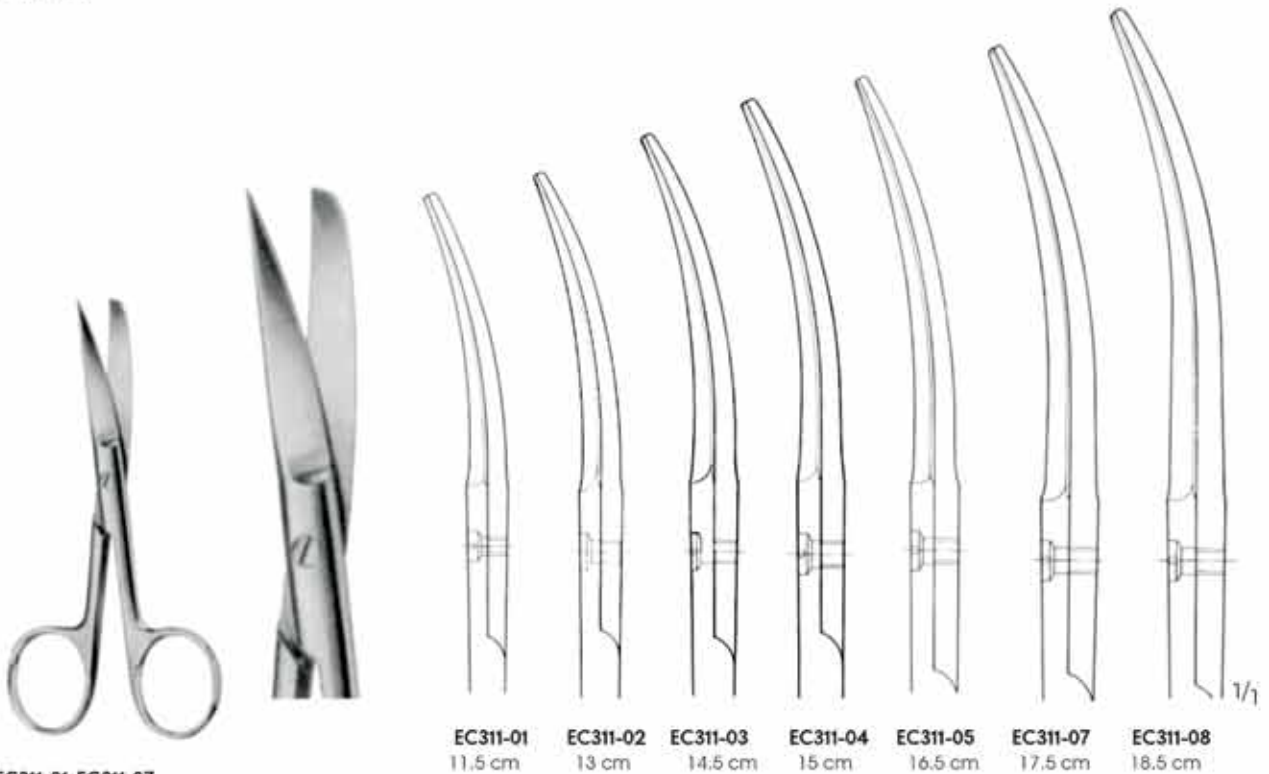

EC311-01-EC311-07

Standart model/Standart patterns
Sivli-Künlü/Sharp-Blunt
Eğri/ Curved



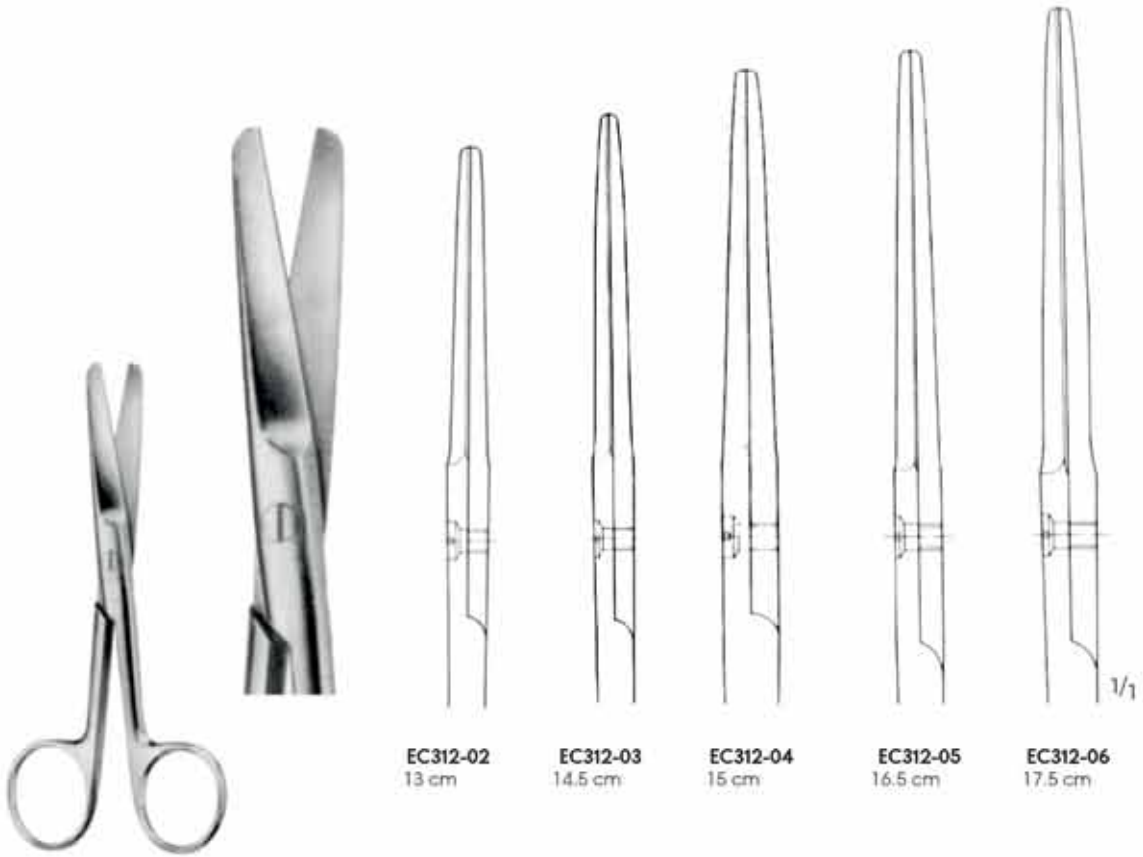

EC312-02-EC312-06
Standart model/Standart patterns
Künt/Blunt
Düz/Straight

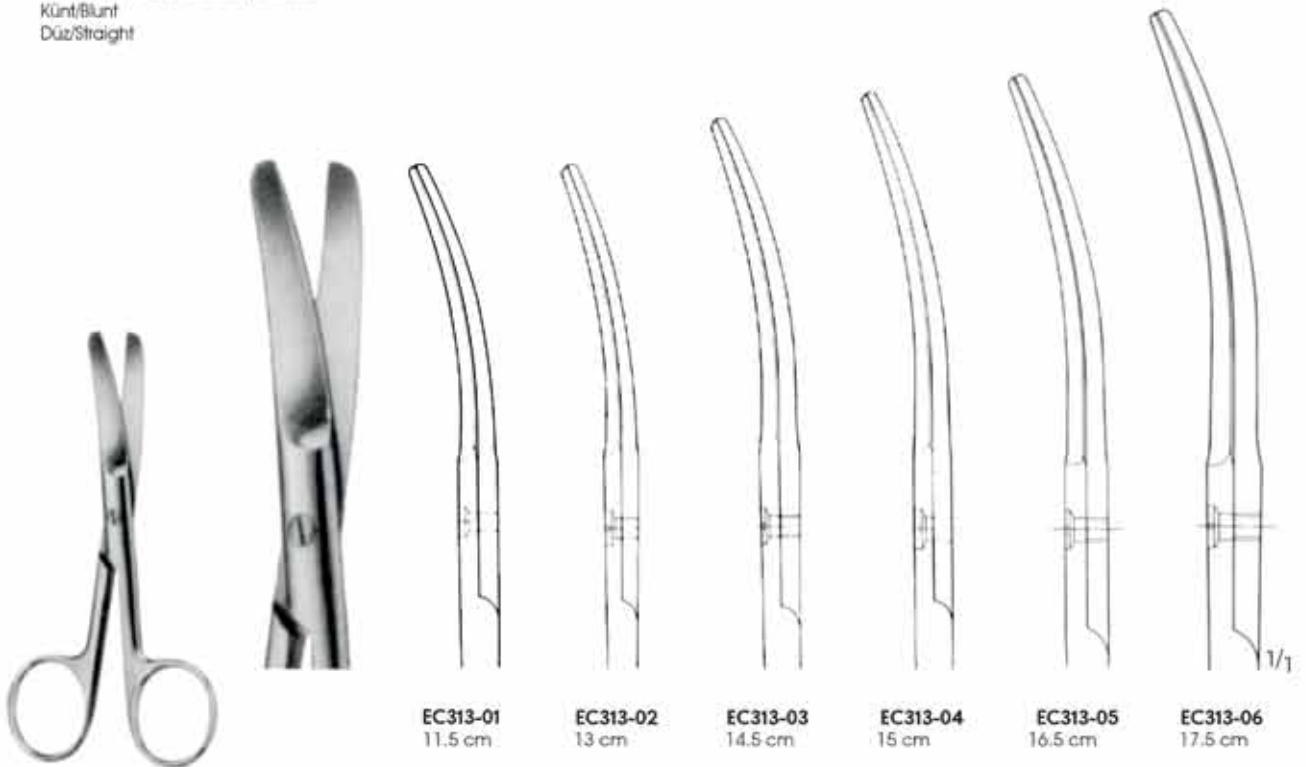

COOPER
EC313-01-EC313-06
Standart model/Standart patterns
Künt/Blunt
Eğri/Curved



EC314-01-EC314-05
Standart model/Standart patterns
Sivri/Sharp
Düz/Straight



EC314-01
11.5 cm



EC314-02
13 cm



EC314-03
14.5 cm



EC314-04
15 cm



EC314-05
16.5 cm



EC315-01-EC315-04
Standart model/Standart patterns
Sivri/Sharp
Eğri/Curved



EC315-01
11.5 cm



EC315-02
13 cm



EC315-03
14.5 cm



EC315-04
15 cm



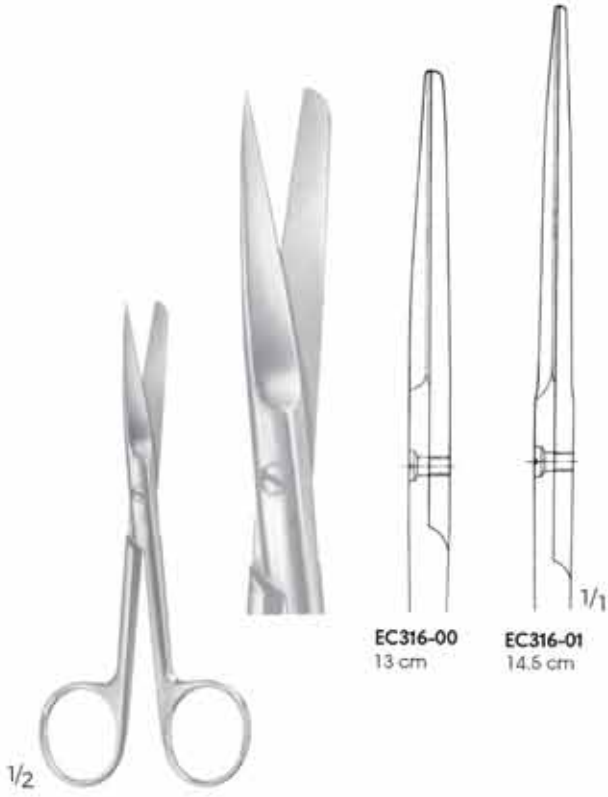

EC316-00
13 cm

EC316-01
14.5 cm

EC316-00-EC316-01
Narin model/Slender patterns
Sivri-Künt/Sharp-Blunt
Düz/Straight



EC317-00
13 cm

EC317-01
14.5 cm

EC317-00-EC317-01
Narin model/Slender patterns
Sivri-Künt/Sharp-Blunt
Eğri/Curved



Tek ağız tırtılı/One jaw serrated

EC318-00
Yara kenar makası/Scissors for wound edges
Sivri-Künt/Sharp-Blunt
Düz/Straight
13 cm



Tek ağız tırtılı/One jaw serrated

EC319-01
Yara kenar makası/Scissors for wound edges
Sivri-Künt/Sharp-Blunt
Eğri/Curved
13 cm



1/2
SYSTRUNK
EC660-00
Sert doku makası/Nail splitting scissors
13 cm



EC330-01
13 cm



EC330-02
14.5 cm



EC330-03
16.5 cm

EC330-01-EC330-03
İnizasyon makasları/Incision scissors
Düz/ Straight

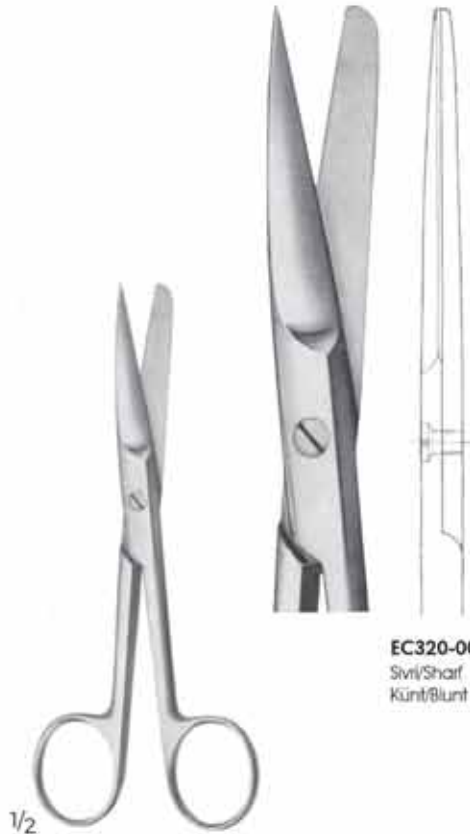

1/2
DEEVER
EC320-00-EC321-01
Cerrahi makaslar/Surgical scissors
14.5 cm



EC320-00
Sivri/Sharf
Künlü/Blunt



EC321-01
Künlü/Blunt





GRAEFE
EC360-00 Kunt/Blunt
Diseksiyon makası/Dissecting scissors
10 cm



EC365-00 Düz/Straight
EC366-00 Eğri/Curved
Diseksiyon makası/
Dissecting scissors
11.5 cm

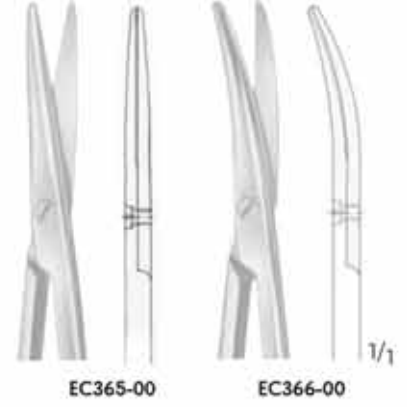

COTTLE
EC368-00
Buldog makası/Bulldog scissors
11.5 cm



LITTLER
EC380-00
Diseksiyon makası ip kesici, delikli
Dissecting scissors, tips with eye suture
11.5 cm



KILNER
EC224-00
Hassas diseksiyon makası
Delicate dissecting scissors
11.5 cm



EC382-00
Eğri/Curved
12.5 cm

EC382-01
Eğri/Curved
15 cm

KILNER

EC382-00-EC382-01

Diseksiyon ve cilt altı için özel düz uçlar
Special flat points for dissecting and
undermining the skin



EC370-00
Sivri/Sharp
10.5 cm

EC371-00
Kütlü/Blunt
10.5 cm

COTTE-MASING

EC370-00-EC371-00

Plastik cerrahi makasları
Scissors for plastic surgery
10.5 cm



EC265-00
Eğri/Curved
11.5 cm

EC266-00
Eğri/Curved
13.5 cm

FOMON

EC265-00-EC266-00

All yanıl makaslar
Lower lateral scissors



LANDOLT

EC268-00

Enukleasyon makası
Enucleation scissors
12 cm





EC396-00
Düz/Straight

EC396-10
Eğri/Curved

1/2

STEVENS
EC396-00-EC396-10
Damar ve tendon makasları
Vascular and tendon scissors
10 cm



1/2

STEVENS
EC397-00
Hassas diseksiyon makası
Delicate dissecting scissors
11 cm

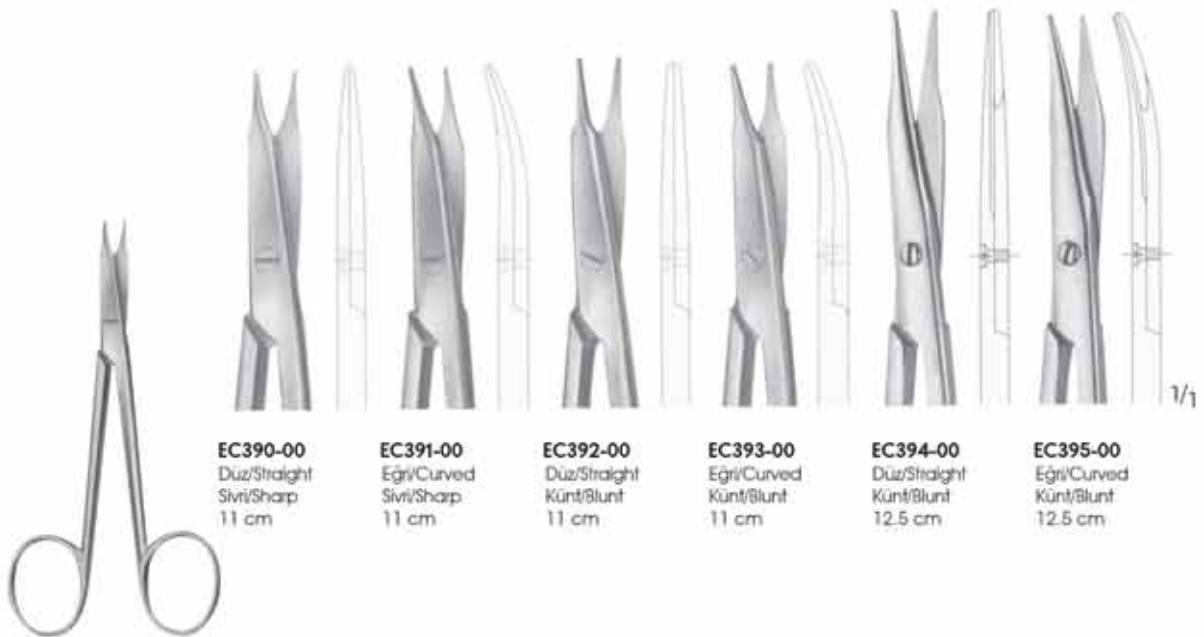

EC390-00
Düz/Straight
Sivri/Sharp
11 cm

EC391-00
Eğri/Curved
Sivri/Sharp
11 cm

EC392-00
Düz/Straight
Künt/Blunt
11 cm

EC393-00
Eğri/Curved
Künt/Blunt
11 cm

EC394-00
Düz/Straight
Künt/Blunt
12.5 cm

EC395-00
Eğri/Curved
Künt/Blunt
12.5 cm

STEVENS
EC390-00-EC395-00
Damar ve tendon makasları
Vascular and tendon scissors



JAMESON-WERBER
EC385-00
Diseksiyon makası
Dissecting scissors
13 cm



JAMESON
EC386-00
Diseksiyon makası
Dissecting scissors
15 cm

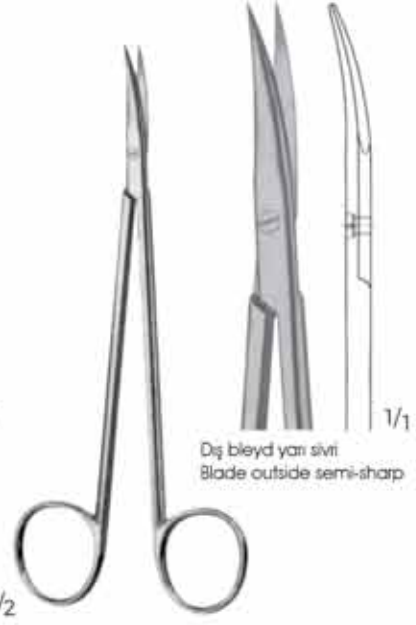

EC258-00
Sinir, diseksiyon makası
Nerve dissecting scissors
15 cm

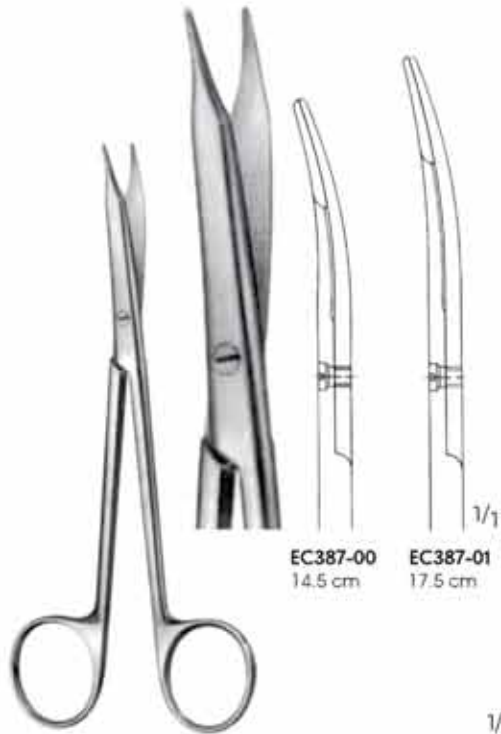

REYNOLDS
EC387-00-EC387-01
Diseksiyon makasları
Dissecting scissors

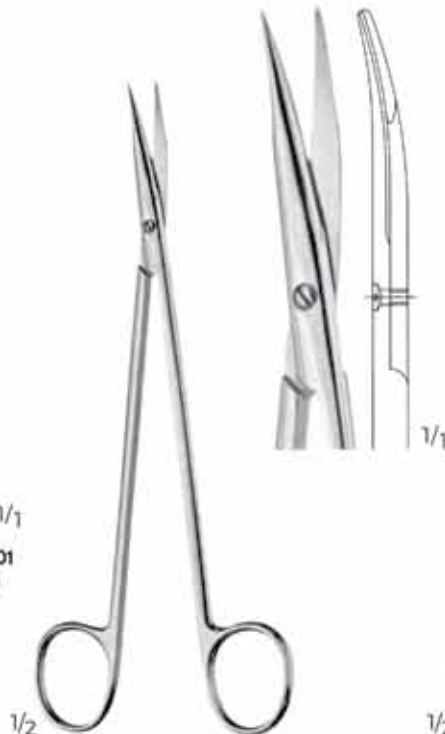

POTTS
EC384-00
Diseksiyon makası
Dissecting scissors
18 cm



DE BAKAY
EC415-00
Arteriyotomi makası
Arteriotomy scissors
17.5 cm





EC410-00
Düz/Straight
Kütlü/Blunt

EC411-00
Eğri/Curved
Kütlü/Blunt

COTTLE-KNAPP
EC410-00-EC411-00
Plastik cerrahi makaslar
Scissors for plastic surgery
10.5 cm



EC412-00
Düz/Straight

EC413-00
Eğri/Curved

BABY-METZENBAUM
EC412-00-EC413-00
Diseksiyon makasları
Dissecting scissors
14.5 cm



EC414-00
Düz/Straight
16 cm

EC414-05
Eğri/Curved
16 cm

METZENBAUM
EC414-00-EC414-05
Diseksiyon makasları
Dissecting scissors



EC416-00
Çok hassas
Very delicate

EC416-01
Hassas
Delicate

TÖNNIS-ADSON
EC416-00-EC414-01
Diseksiyon makasları
Dissecting scissors
17.5 cm



1/2

TONNIS
EC418-00-EC419-00
Diseksiyon makasları
Dissecting scissors
18 cm

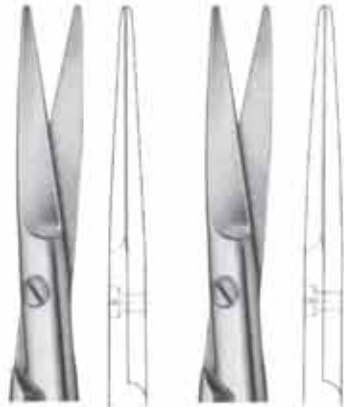

EC418-00
Çok hassas
Very delicate

EC418-01
Hassas
Delicate



EC419-00
Hassas
Delicate

1/1



1/2

EC435-00
Kıkırdak makası, çift ağız tırtıklı
Cartilage scissors, blades
cutting on both sides
18.5 cm

Sırt/Sharp

1/1



1/2

GORNEY
EC430-00
Diseksiyon makası plastik cerrahi için
Dissection scissor for plastic surgery
12.5 cm



1/1

Bleyd : Dış taraflar yan keski
İç taraflar ince tırtıklı
Blade : Outside semi-sharp
Inside fine serrated

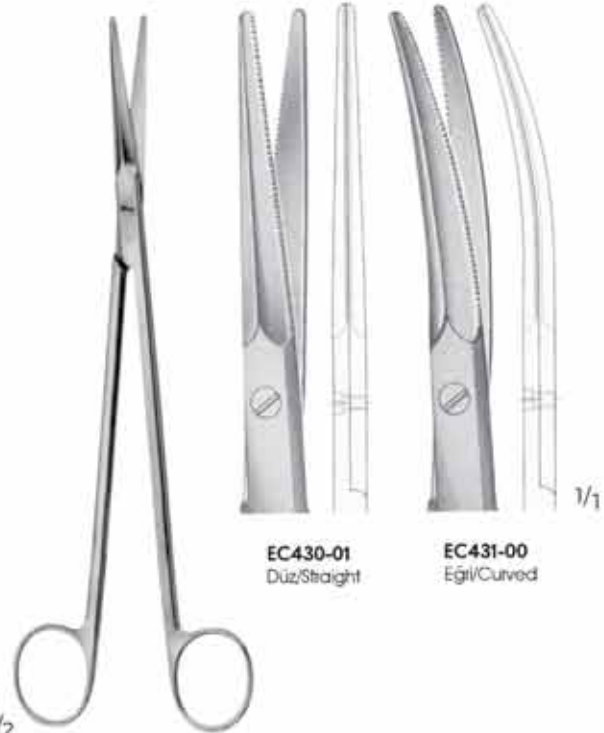

1/2

GORNEY
EC430-01-EC431-00
Diseksiyon makasları plastik cerrahi için
Dissection scissors for plastic surgery
19.5 cm

EC430-01
Düz/Straight

EC431-00
Eğil/Curved

Bleydler : Dış taraflar yan keski
İç taraflar ince tırtıklı
Blades : Outside semi-sharp
Inside fine serrated



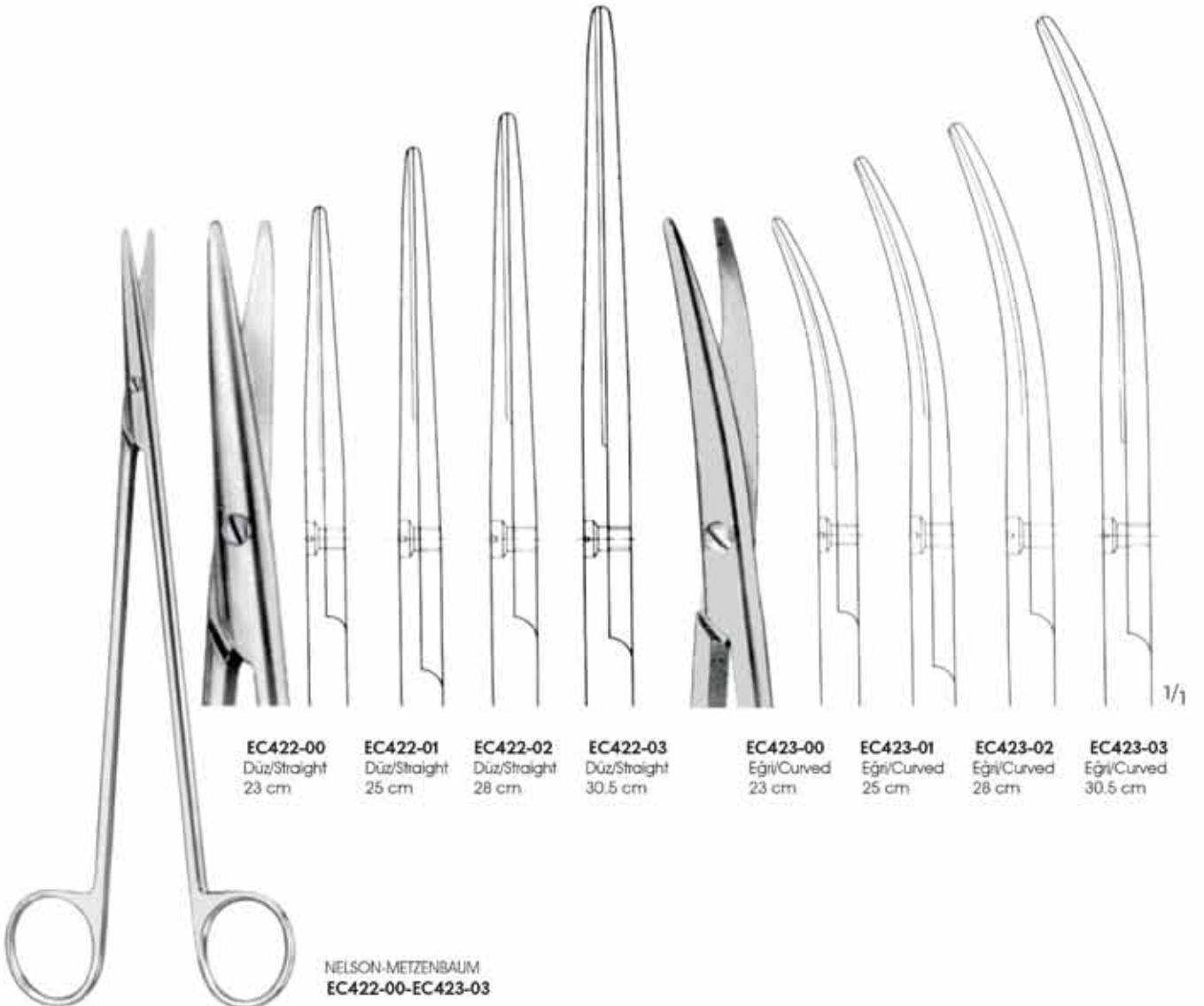
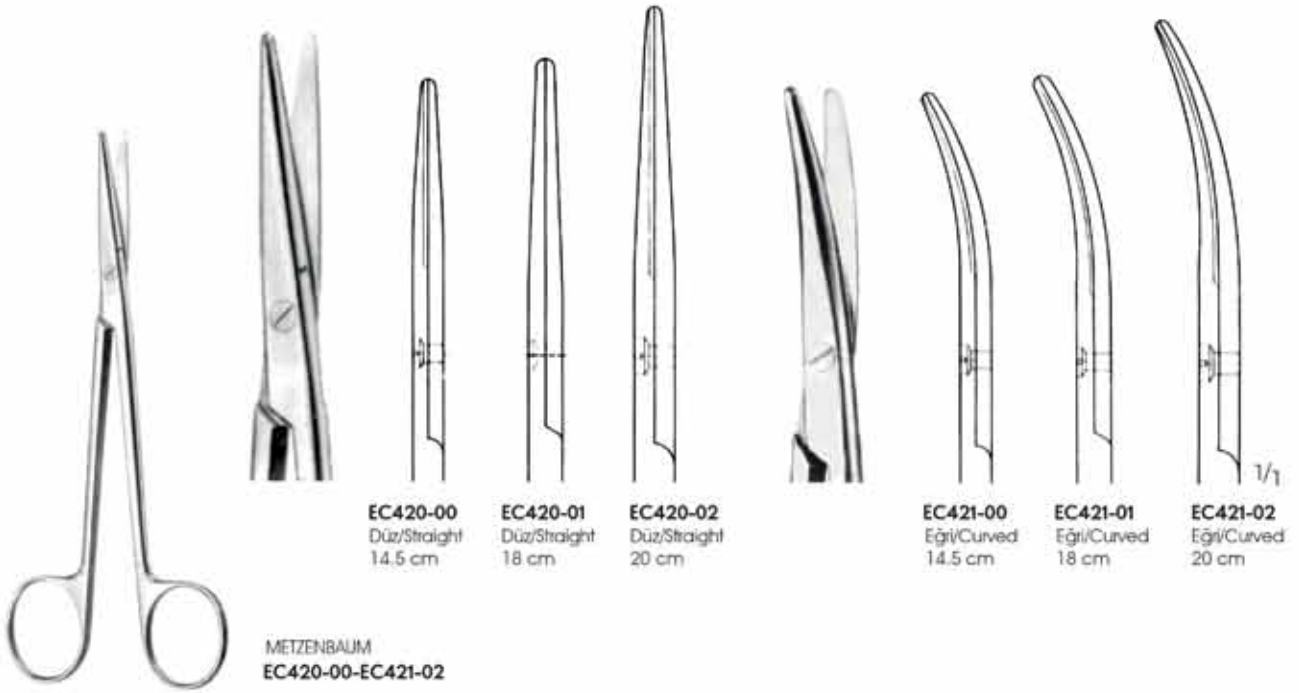



MAYO-STILLE
EC446-00-EC447-01
Uc kısmı oyuk yapıklı
With chamfered blades



EC446-00
14 cm



EC446-01
17 cm



EC447-00
14 cm



EC447-01
17 cm



MAYO
EC449-00-EC450-01
Uc kısmı oyuk yapıklı
With chamfered blades



EC449-00
19 cm



EC449-01
21.5 cm



EC450-00
19 cm



EC450-01
21.5 cm



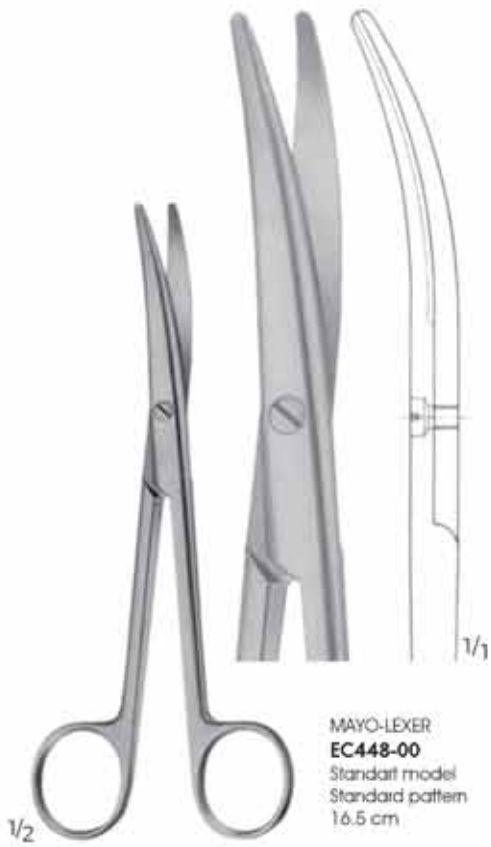
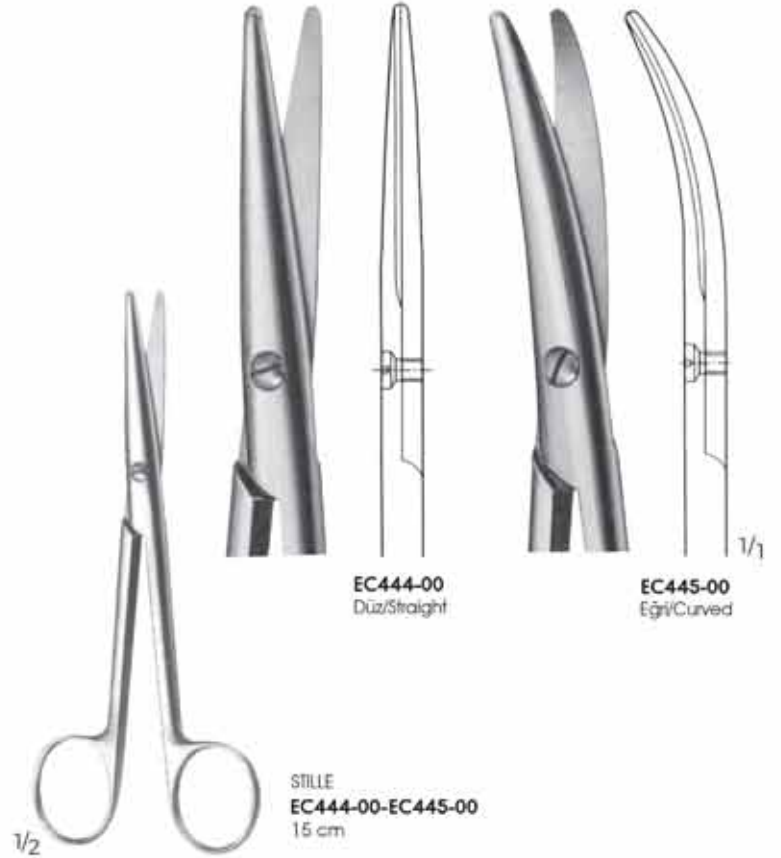
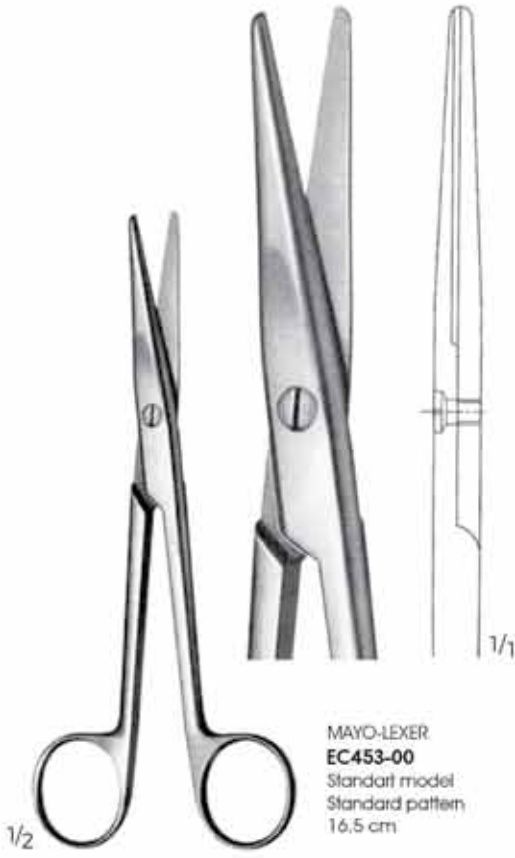

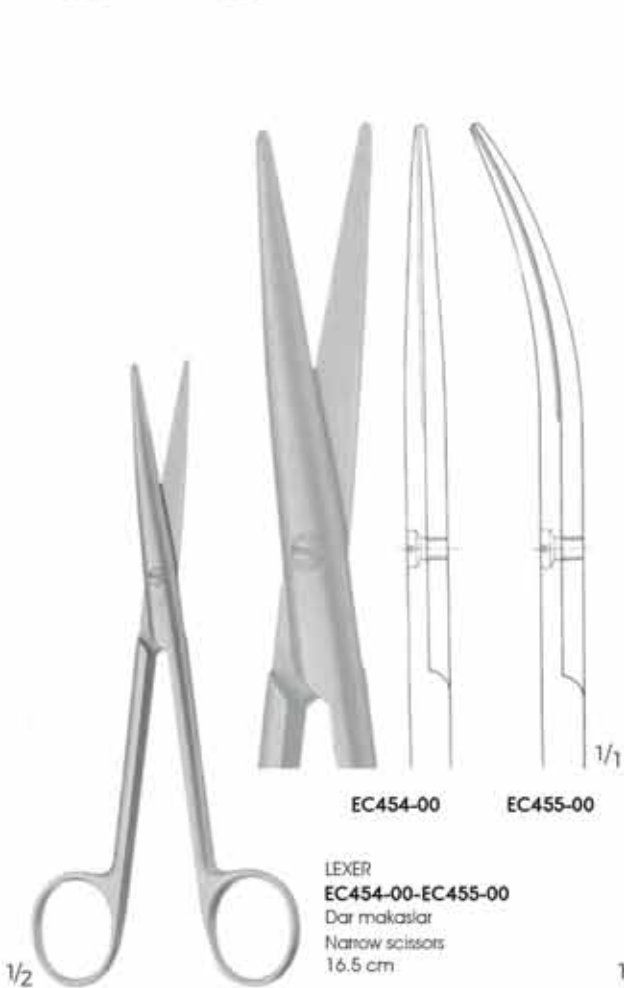

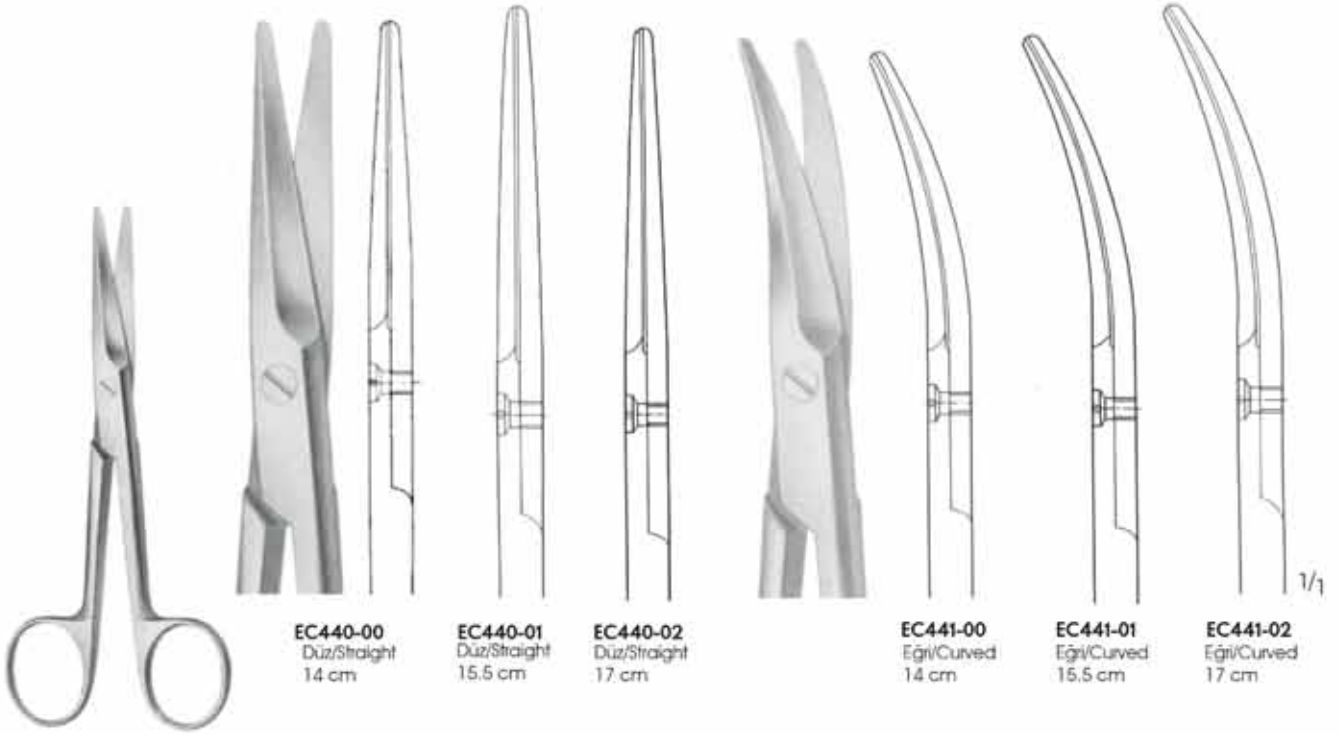

MAYO
EC440-00-EC441-02

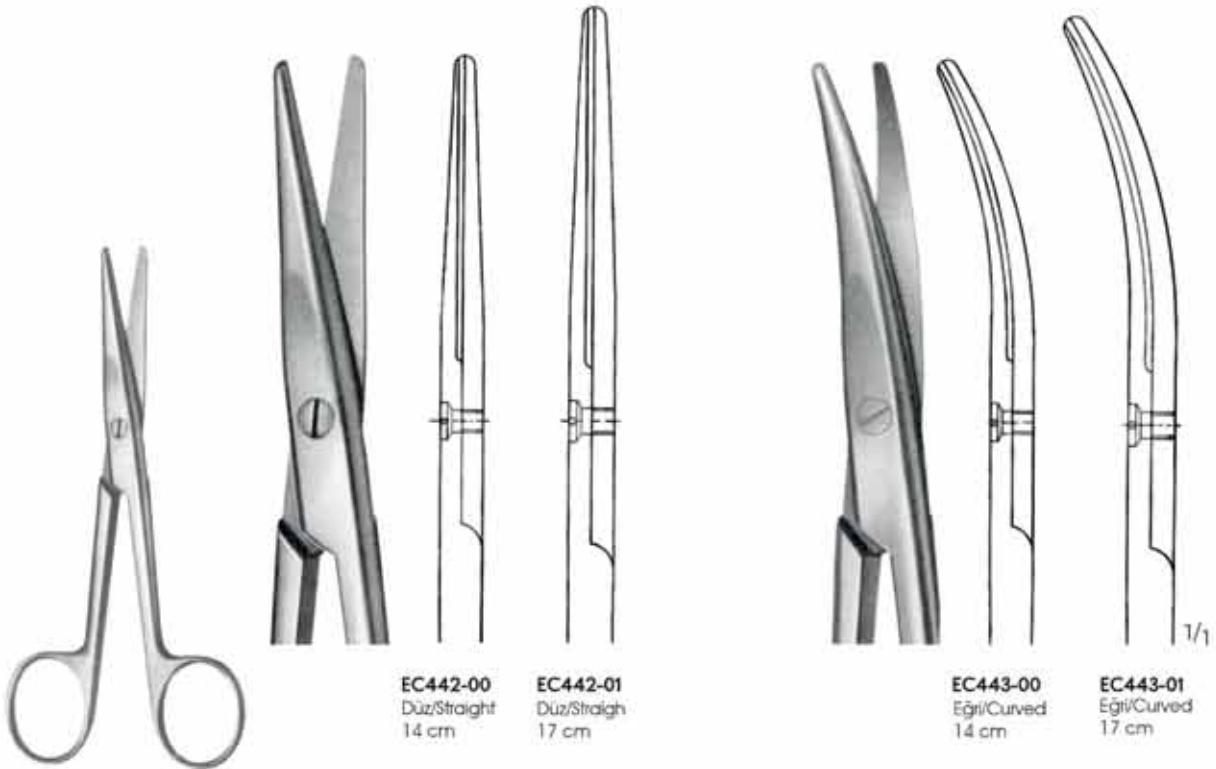

MAYO-STILLÉ
EC442-00-EC443-01

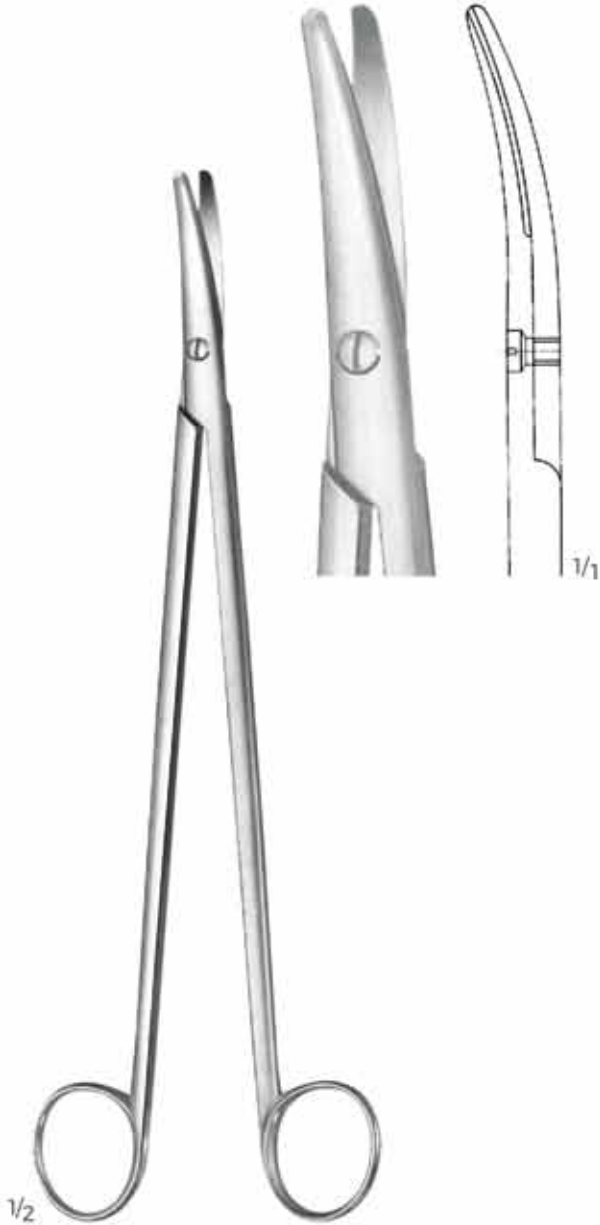

WELLER
EC425-00
Diseksiyon makası, zayıf bölgelerde
Dissecting scissors, heavy pattern
28 cm

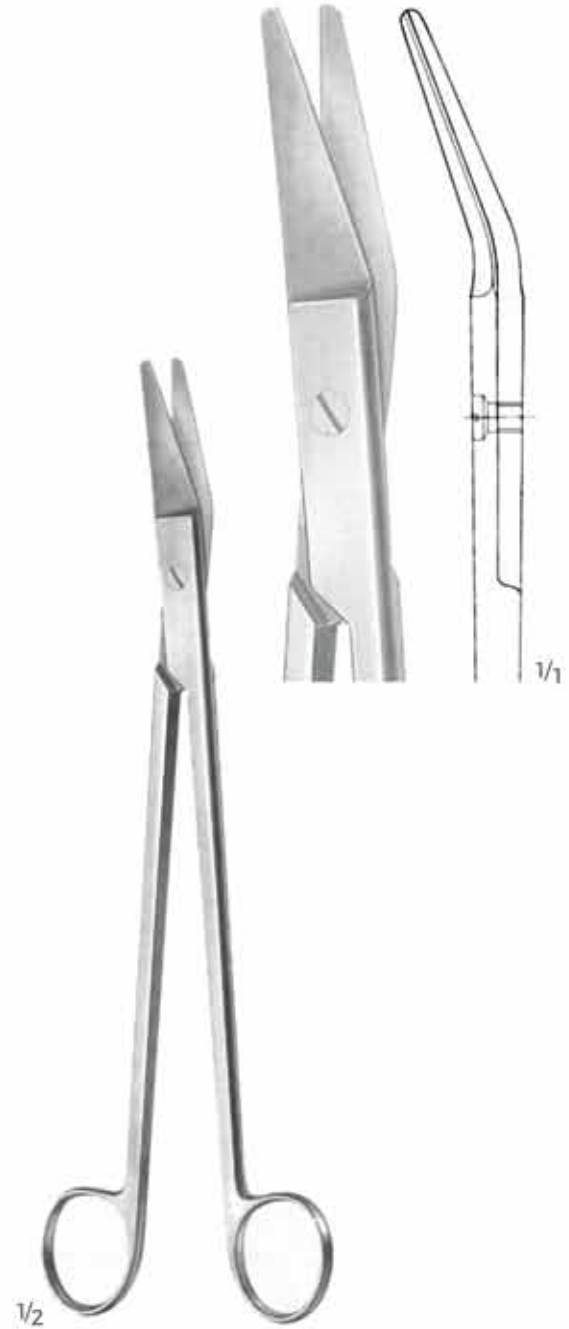

RESANO
EC620-00
Kırıldak makası/Cartilage scissors
25 cm



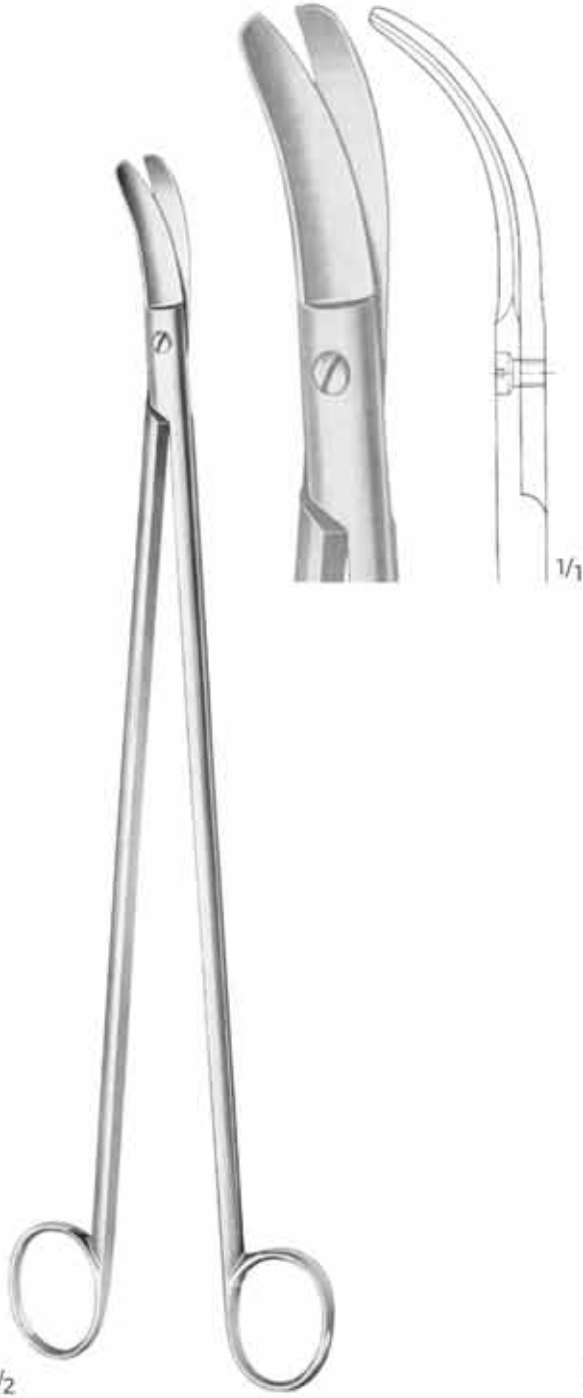

EC579-04
Rektal makas/Rectal scissors
32.5 cm

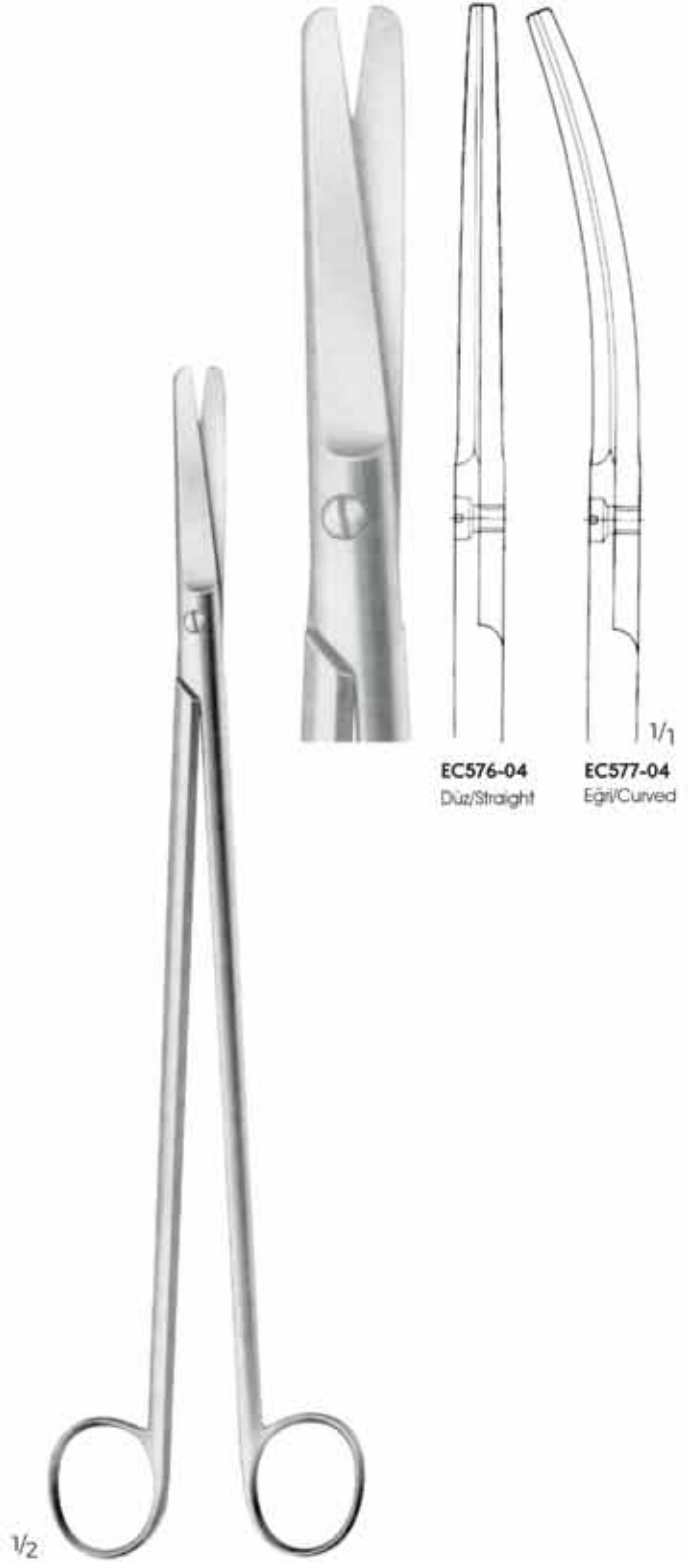

STELZNER
EC576-04-EC577-04
Rektal makas/Rectal scissors
31 cm

EC576-04
Düz/Straight

EC577-04
Eğri/Curved

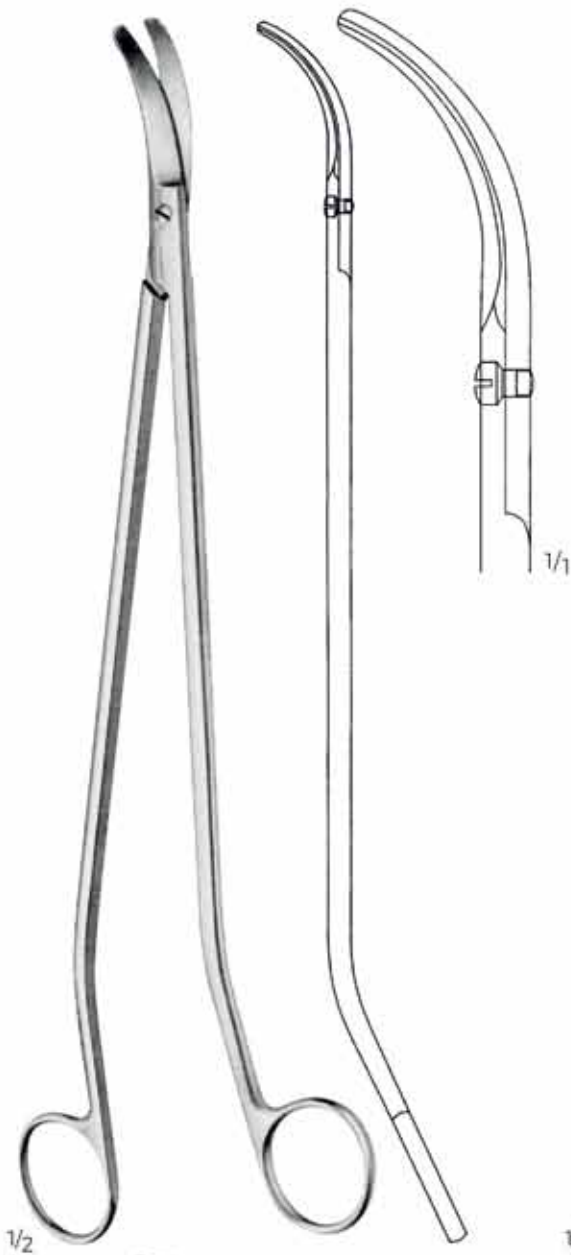

MÜLLER
EC578-00
Rektal makas/Rectal scissors
S-şeklinde/S-shaped
32.5 cm

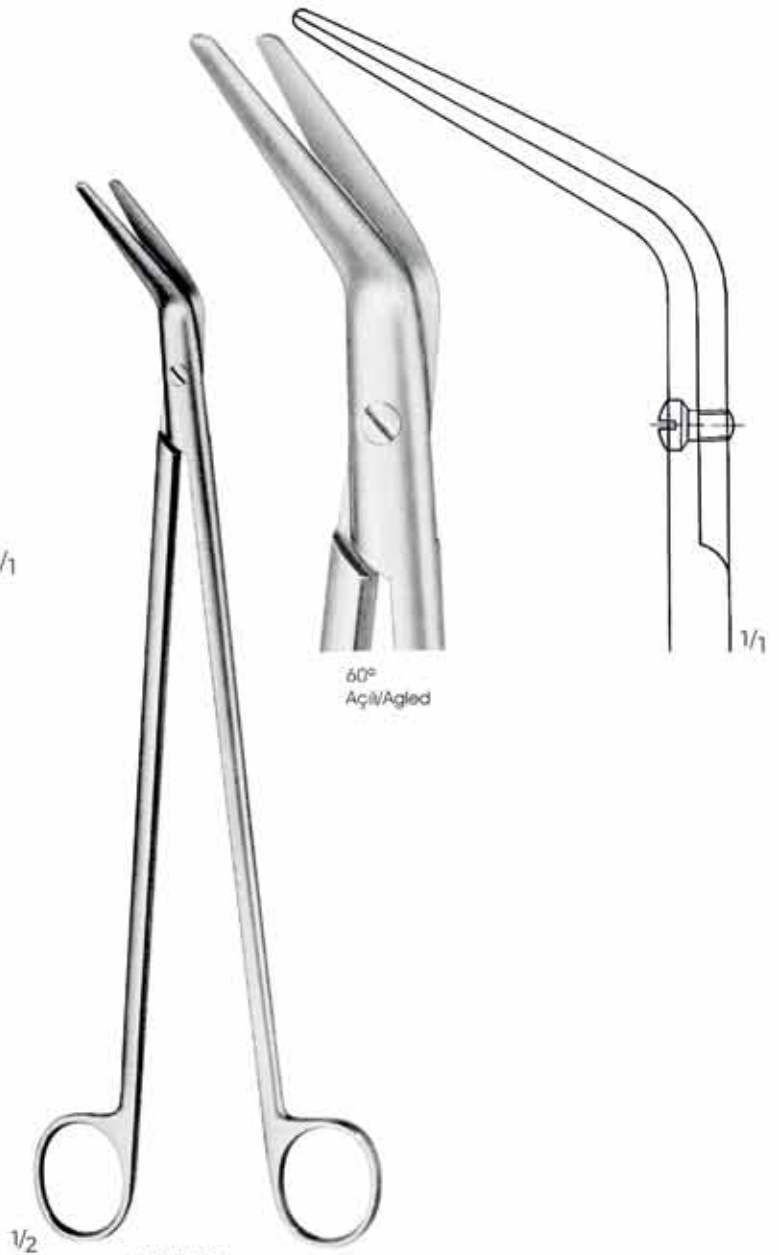

EC575-00
Dikiş atıldıktan sonra bağırsak
kesmek için disseksiyon makası
Dissecting scissors for cutting
of the bowel after suturing with
suture device
28 cm





KEIBACK
EC614-00-EC614-02
Parametrium makası
Parametrium scissors

EC614-00 24 cm
EC614-02 35 cm

KEIBACK
EC615-00-EC615-02
Parametrium makası, yana kavış, tek ağız sonda ucu
Parametrium scissors, curved to side, with one probe pointed blade

EC615-00 26 cm
EC615-02 35 cm

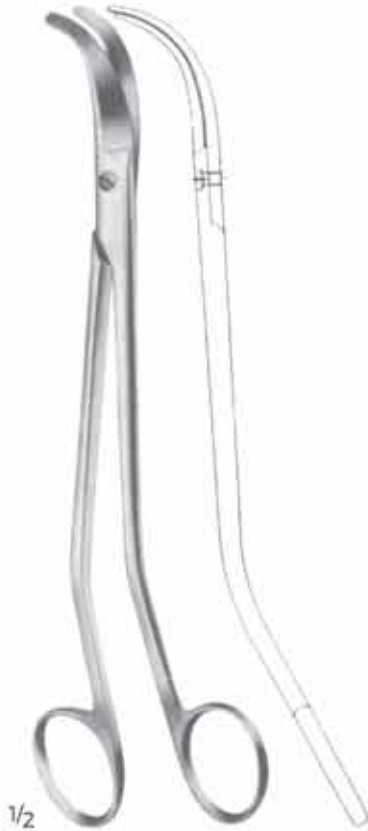

**BOZEMANN
EC490-00**
Rahim makası/Uterine scissors
22 cm



**SIEBOLD
EC491-00**
Rahim makası/Uterine scissors
24.5 cm





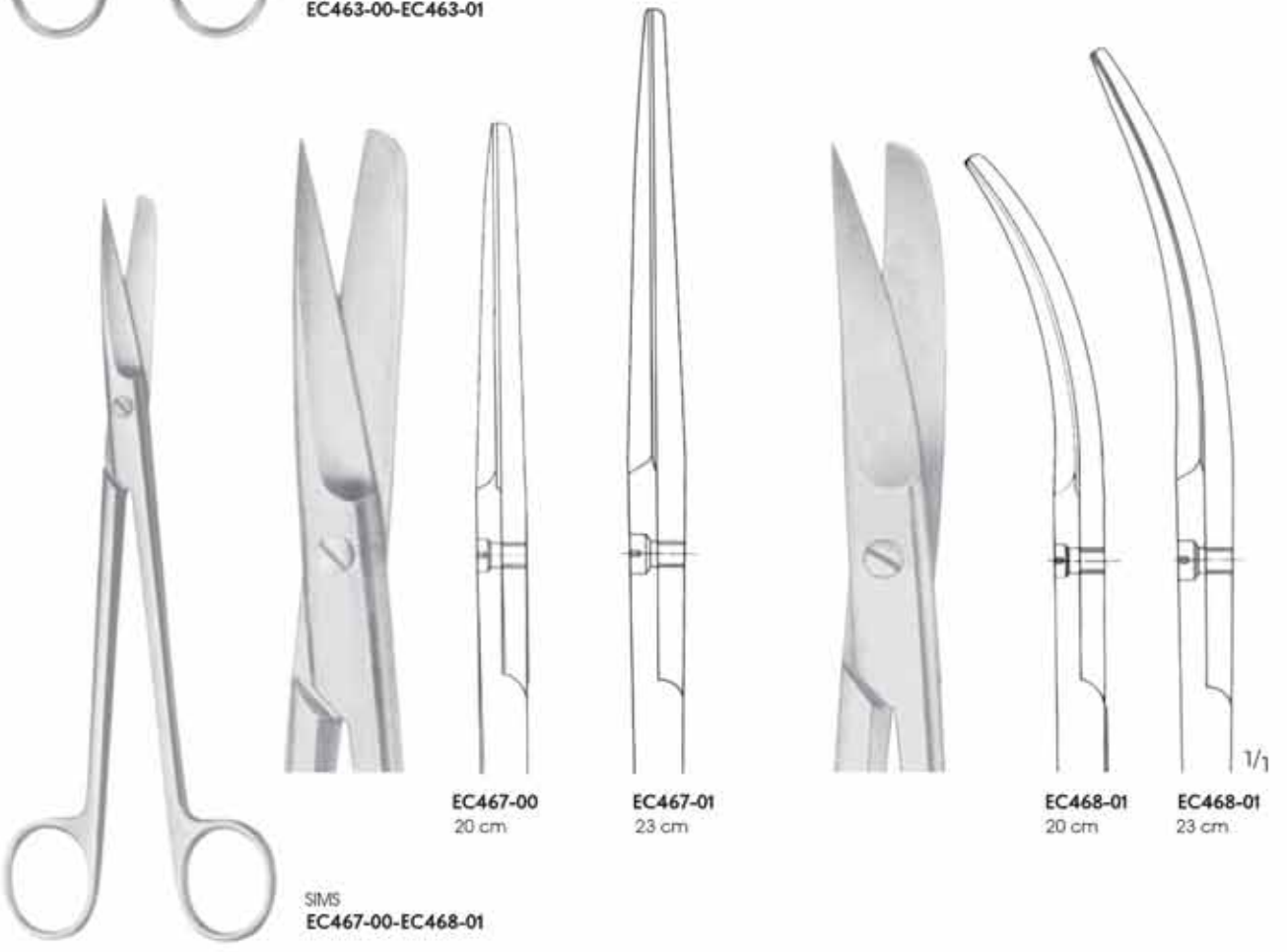
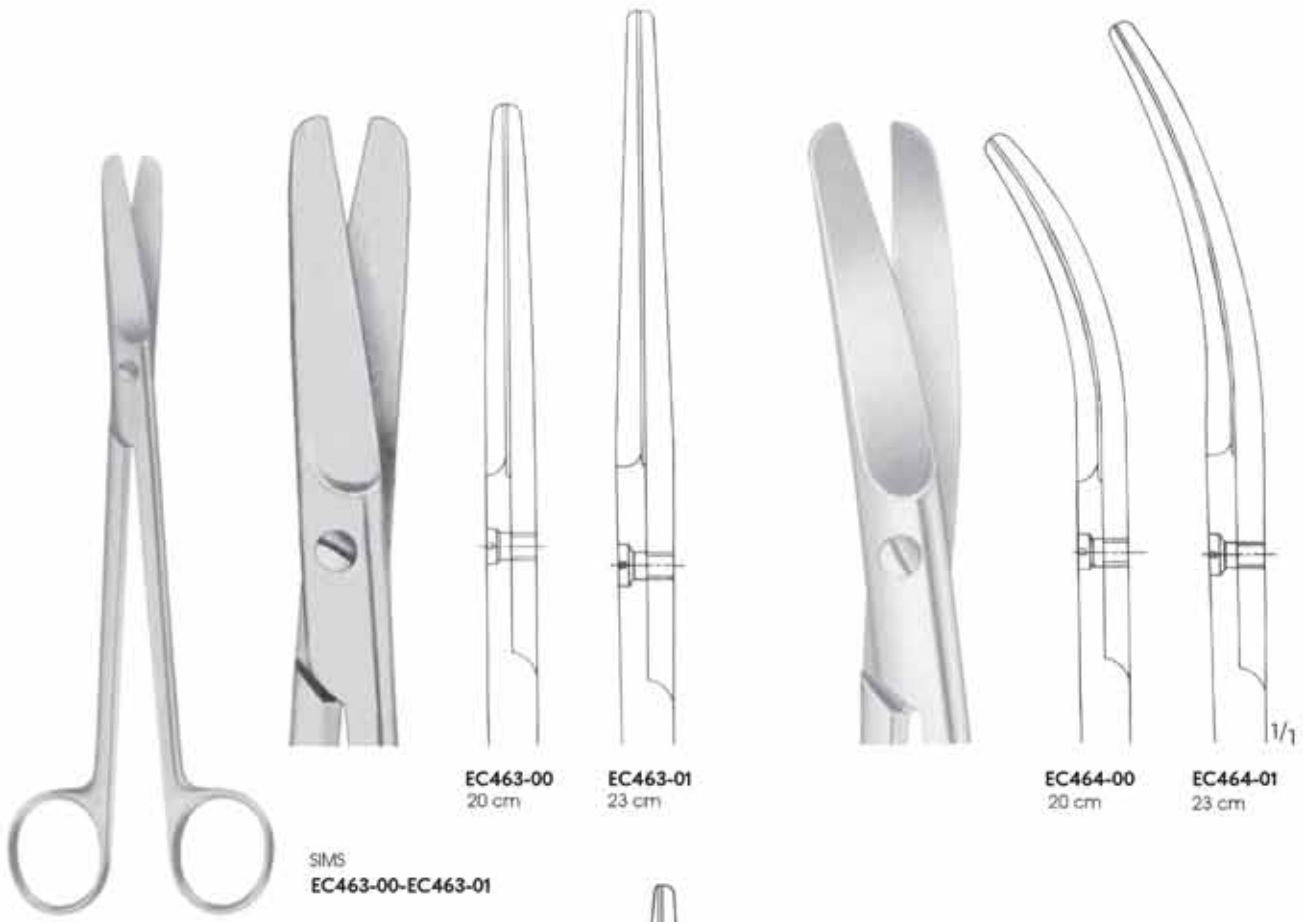

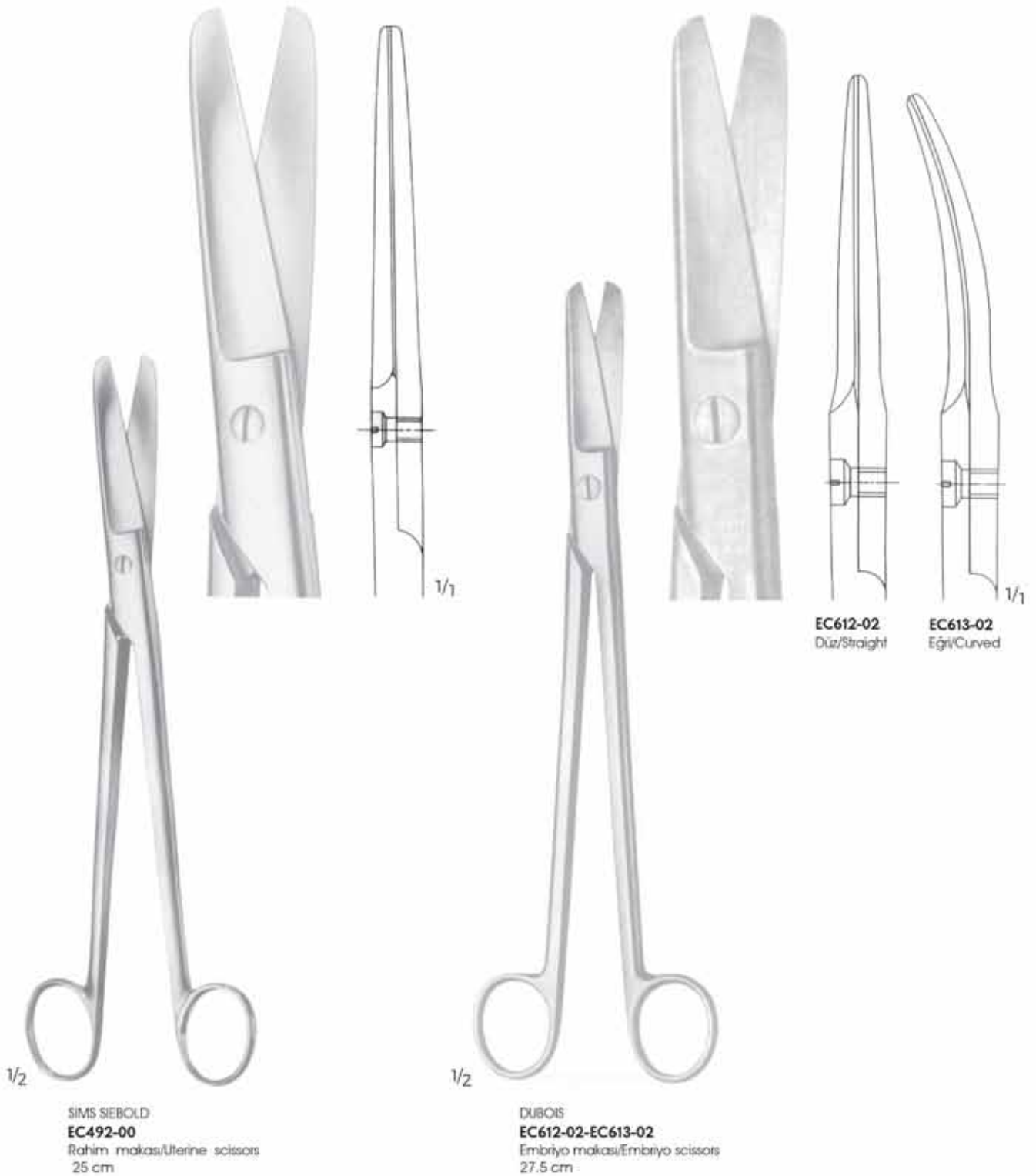

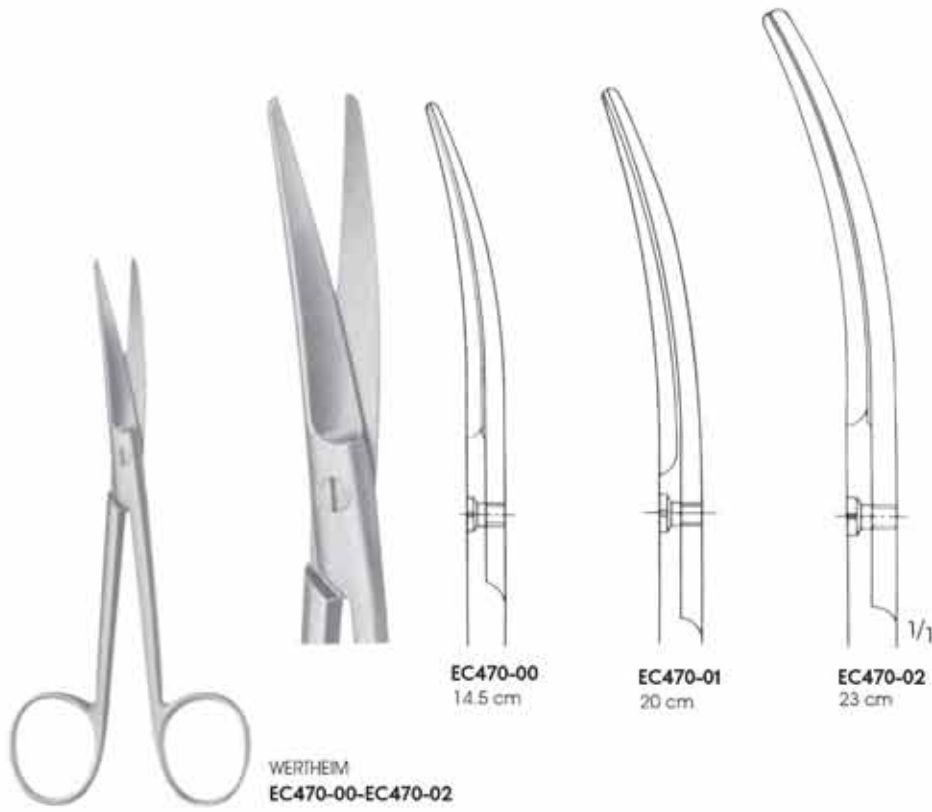

WERTHEIM
EC470-00-EC470-02

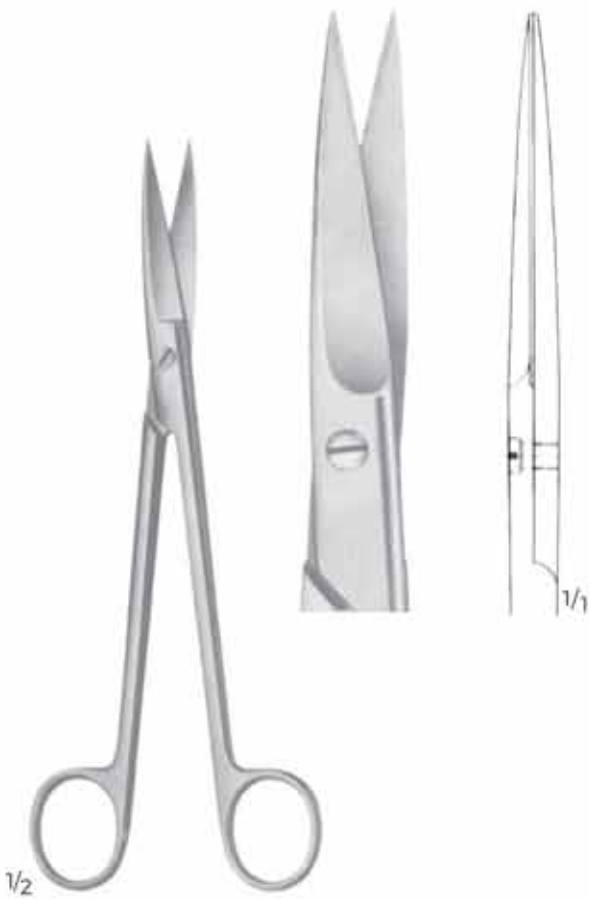

SIMS
EC472-00
20 cm

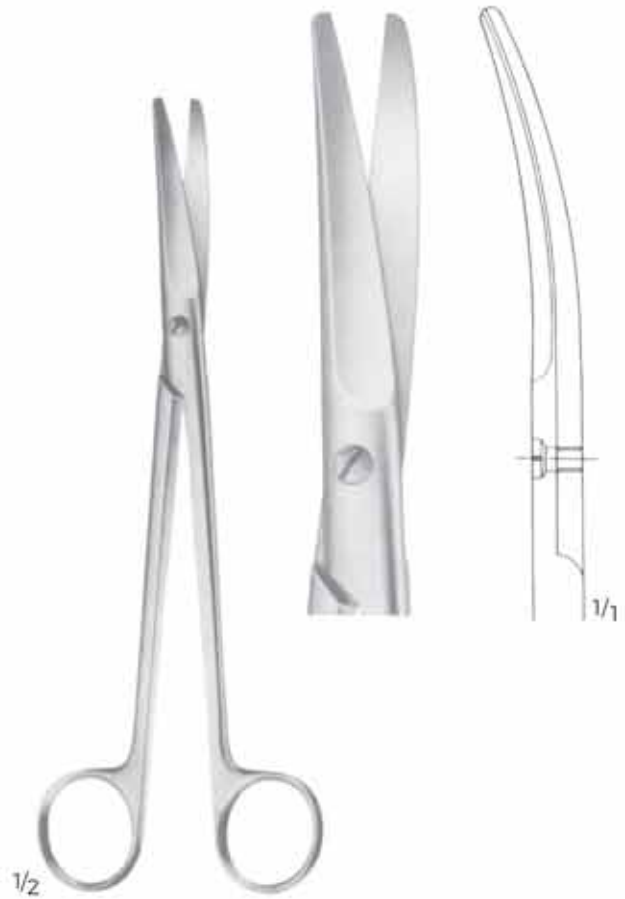

SIMS
EC474-00
21 cm



Standart bıyık
Standard blade



EC513-30



EC513-31



EC513-33



EC513-34



EC513-35

Hassas bıyık
Delicate blade



EC513-10



EC513-11



EC513-13

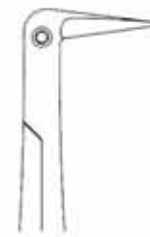

EC513-14



EC513-15

Ultra hassas bıyık
Ultra delicate blade



EC513-00



EC513-01



EC513-03



EC513-04



EC513-05

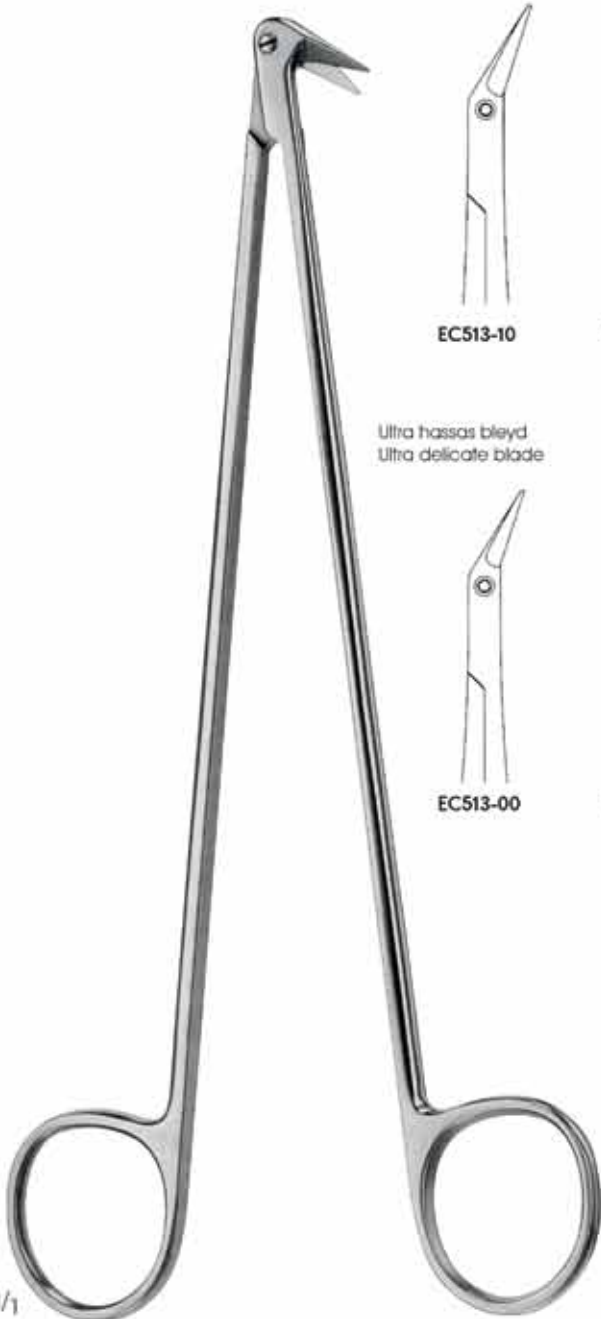

EC513-00-EC513-35
18 cm

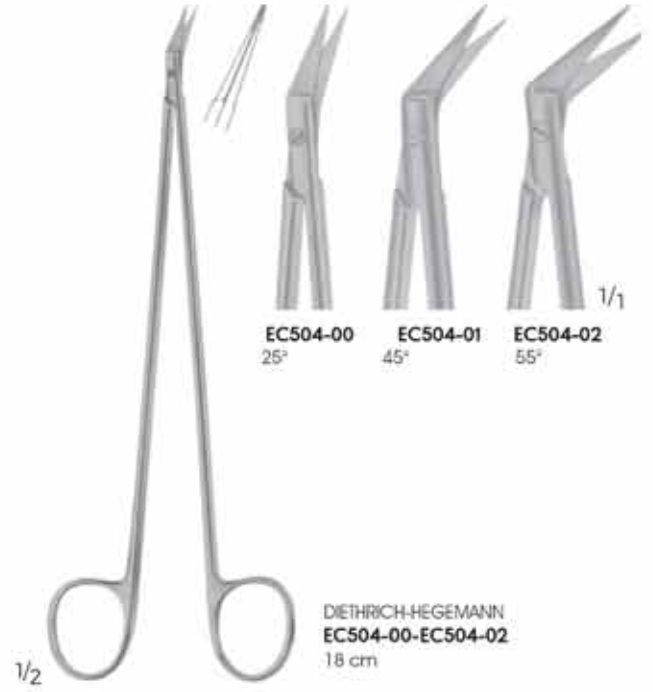

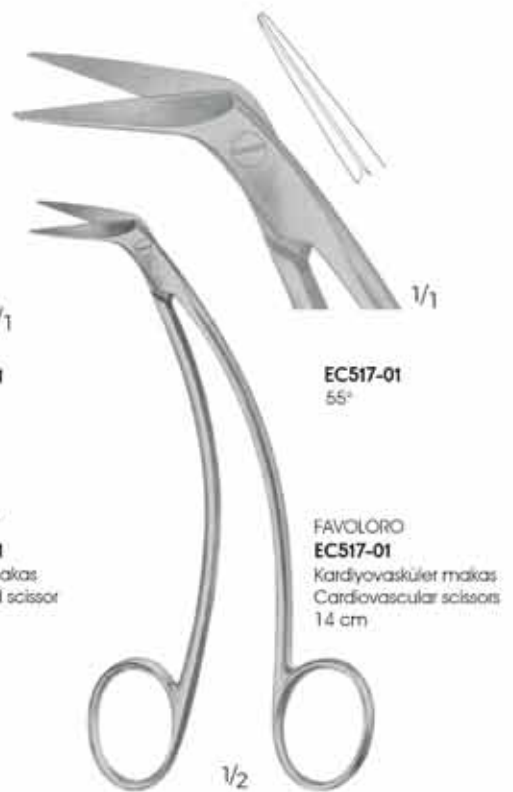
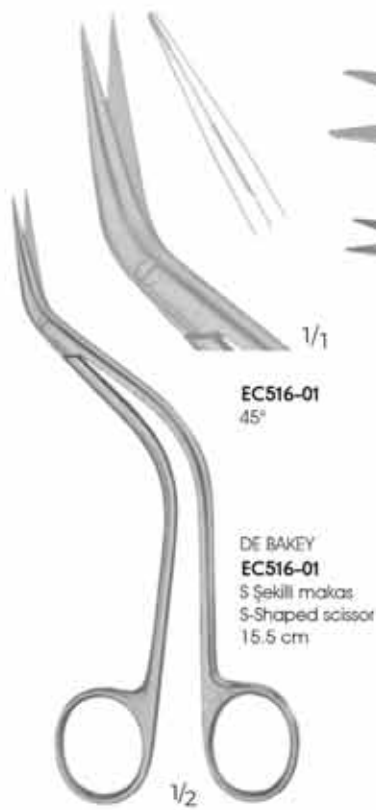
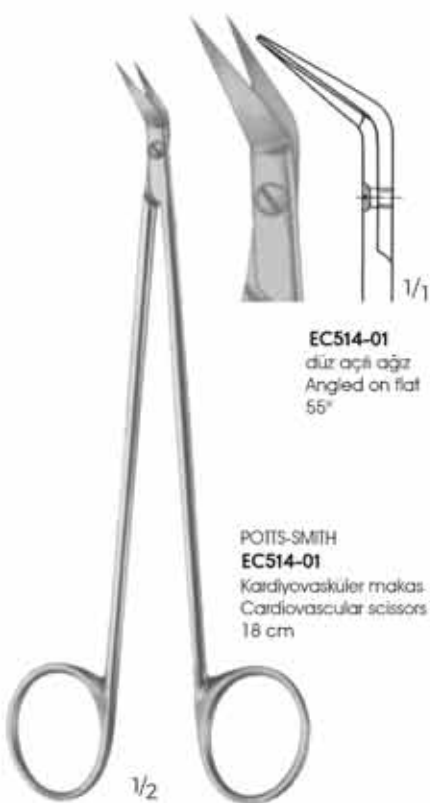
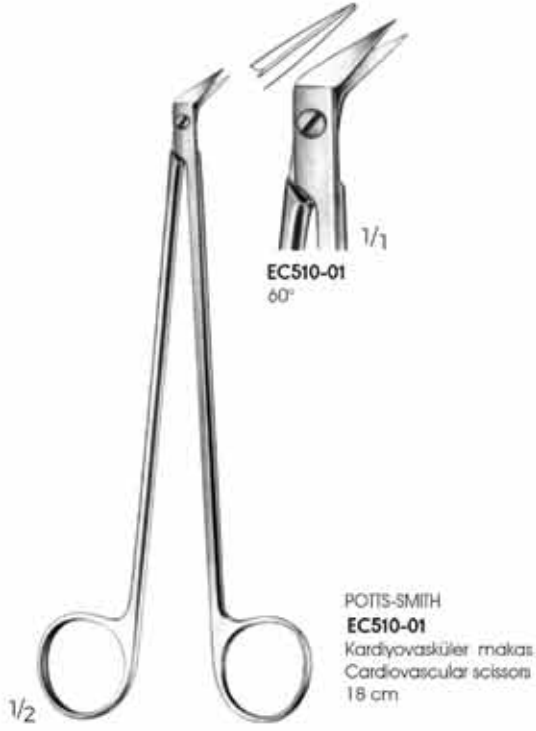

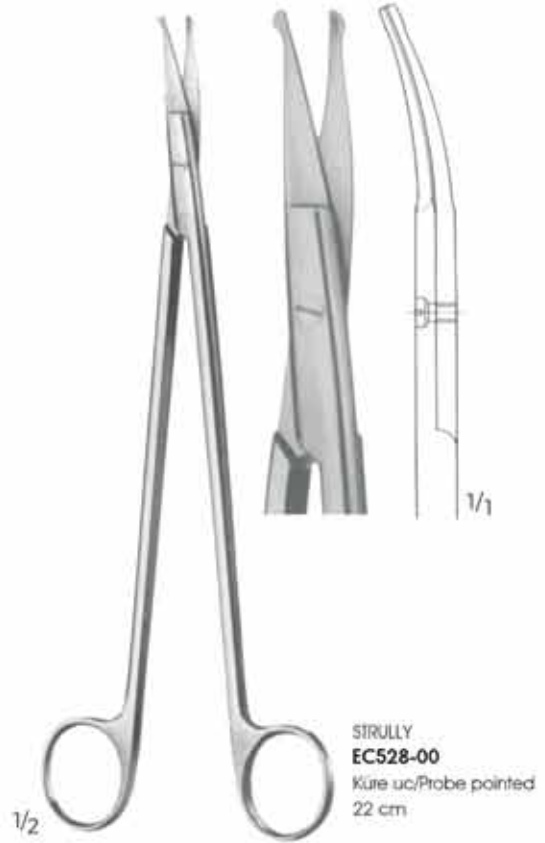
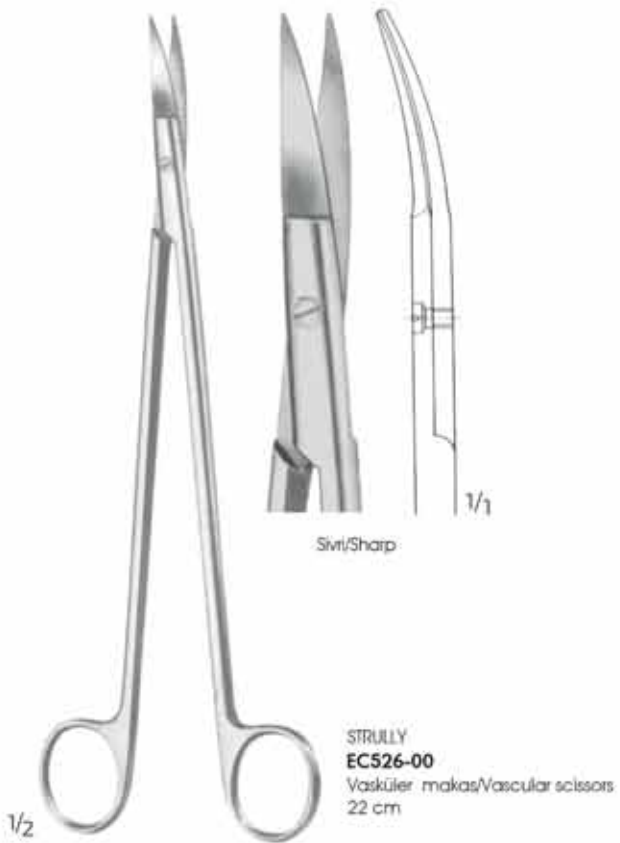
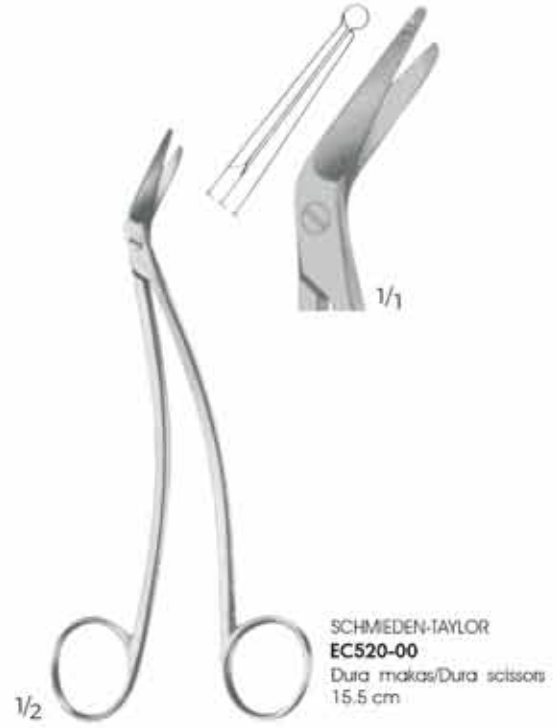
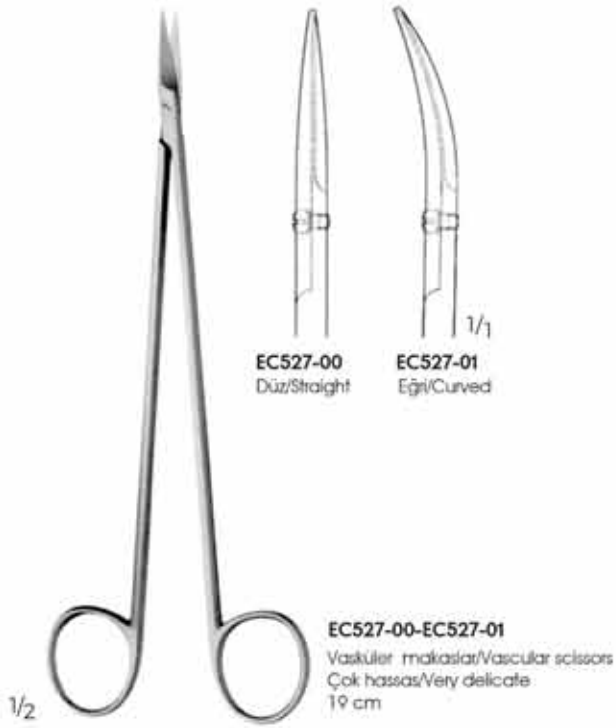

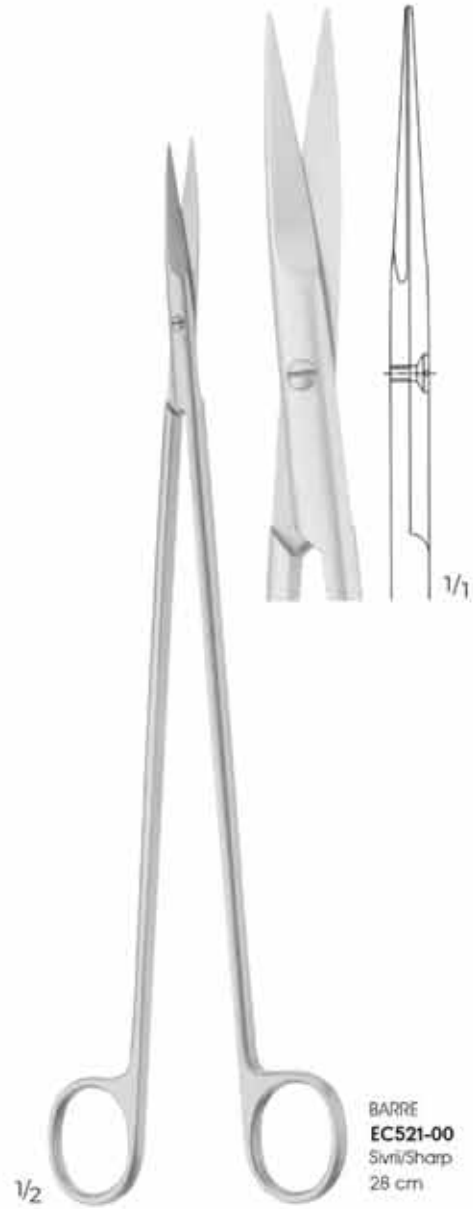
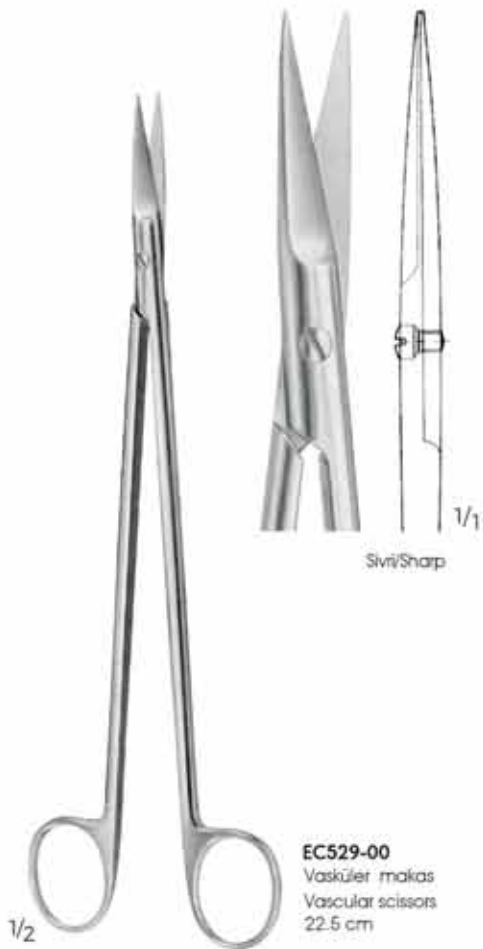
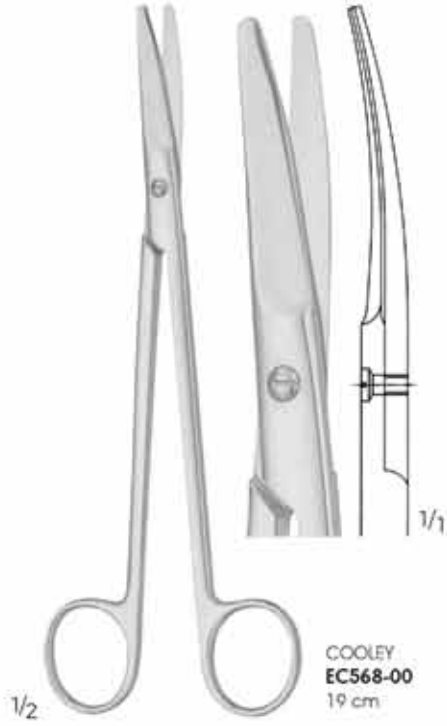

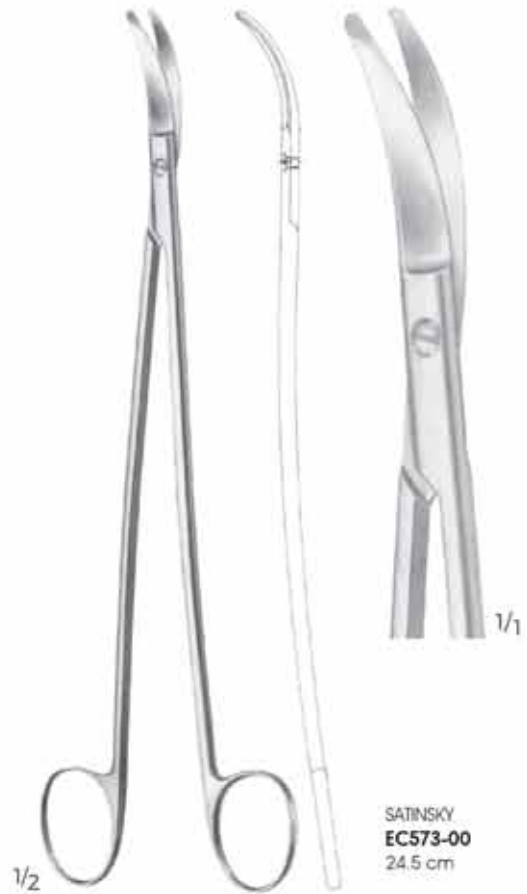
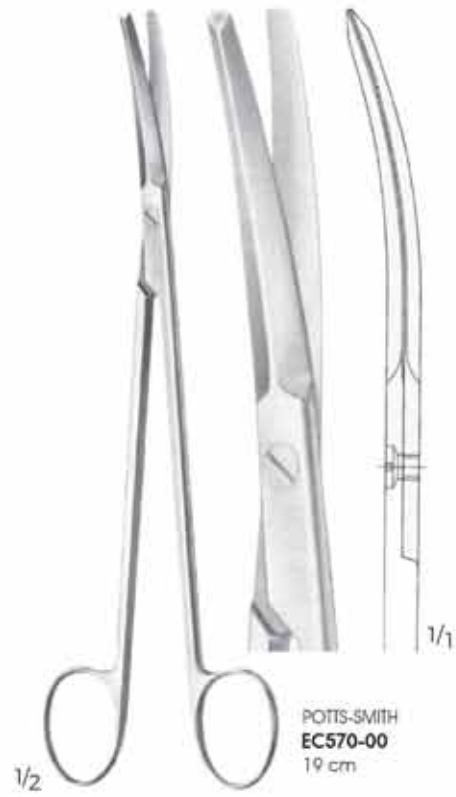
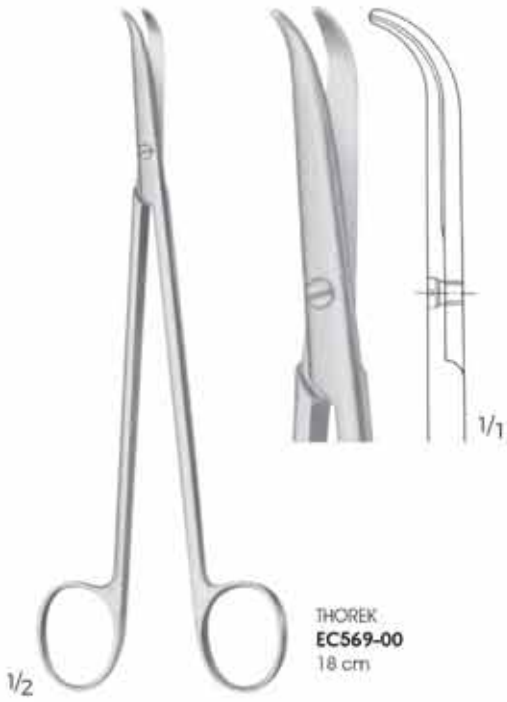



EC600-00
Göbek kordonu makası
Umbilical cord scissors
10,5 cm



SCHUMACHER
EC602-00
Göbek kordonu makası
Umbilical cord scissors
15,5 cm



EC603-00-EC603-01
Göbek kordonu makasları
Umbilical Cord scissors



EC603-00
13,5 cm



EC603-01
16 cm



BRAUN-STADLER
EC604-00-EC604-01

Epizyotomi makasları/Episiotomy scissors



EC604-00
14.5 cm



EC604-01
20 cm



EC610-00

Epizyotomi makası/Episiotomy scissors
24 cm



BRAUN-STADLER

EC632-00

Bandaj makası/Bandage scissor
22.5 cm



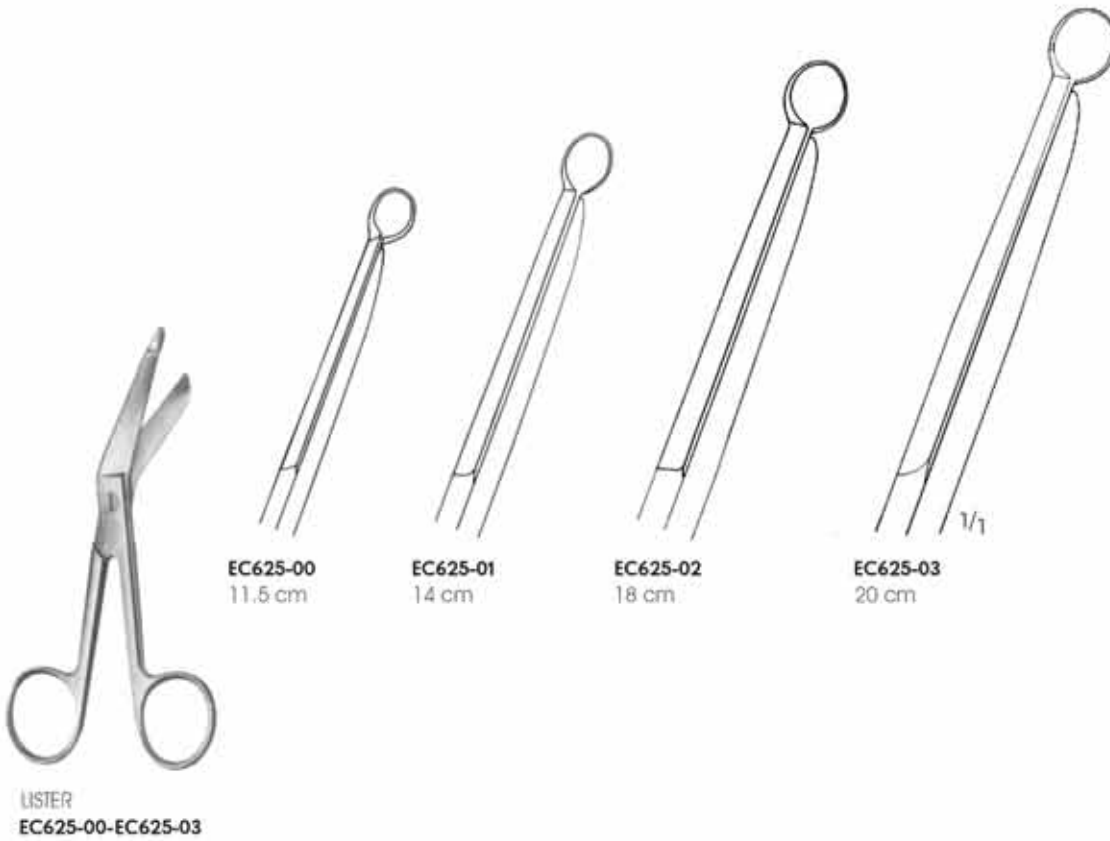
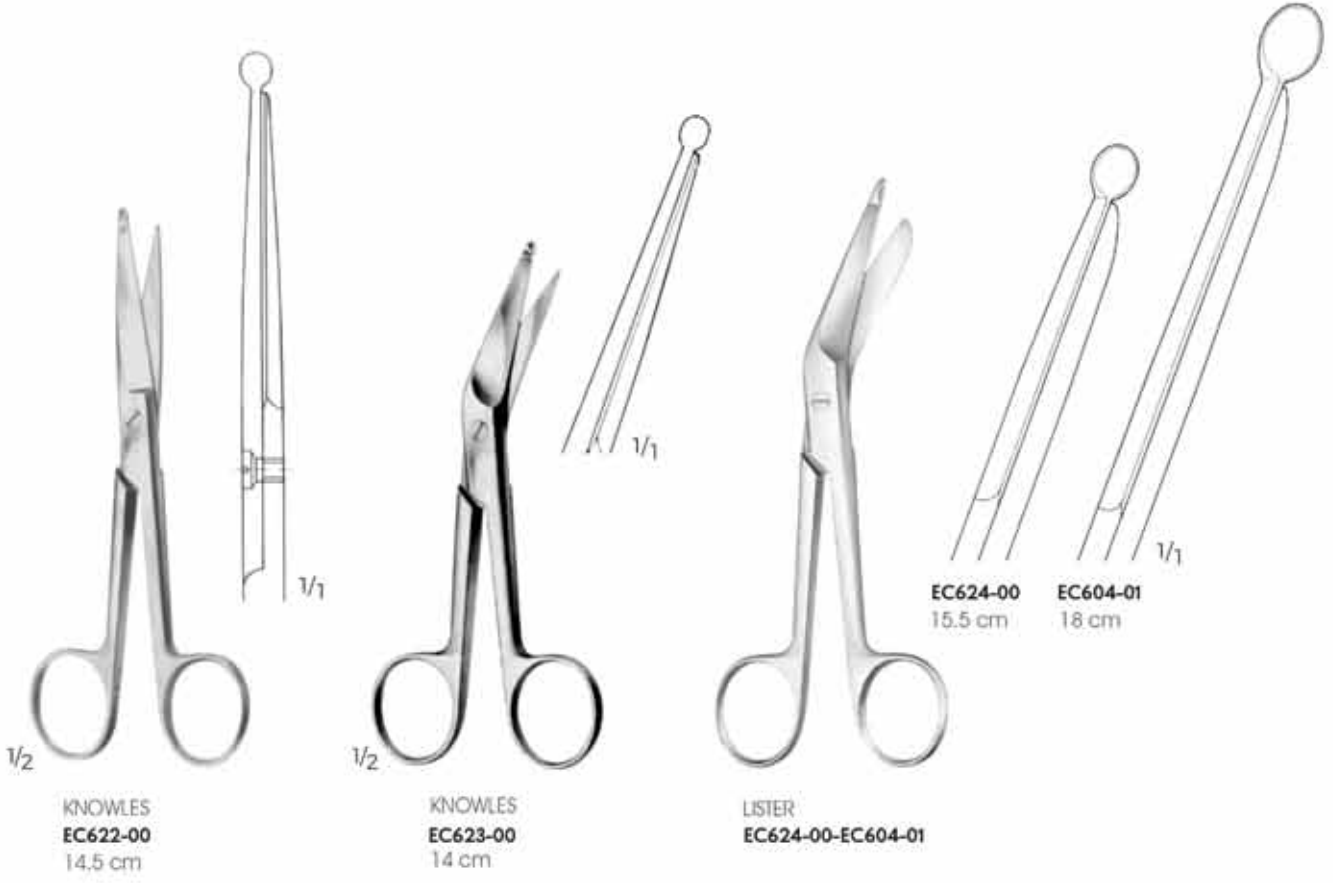

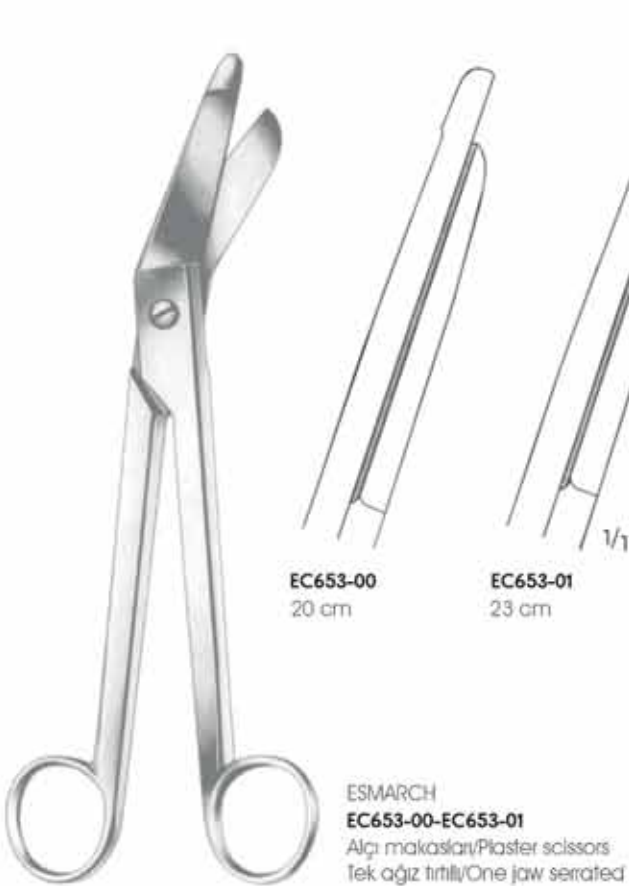

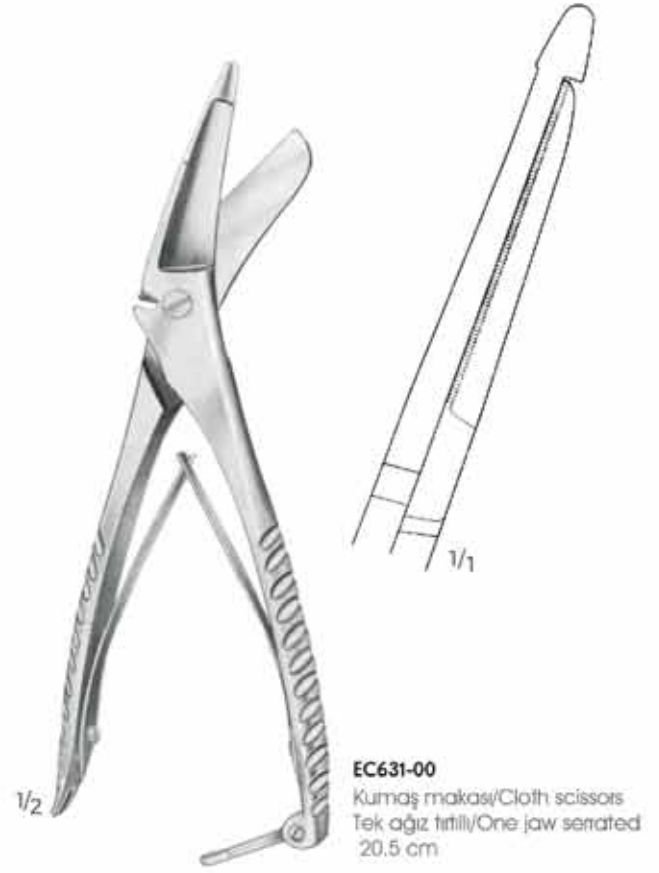



KILLIAN
EC695-00
Çift ağız tırtilli
Both jaws serrated
20 cm



MUHLING
EC695-01
21 cm



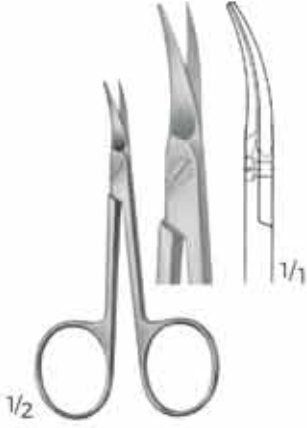

EC217-01
Tırnak makası
Nail scissors
9 cm



EC217-00
Hassas bölge için tırnak makası
Nail Scissors, especially delicate
pattern
9 cm



EC218-00
Çocuk tırnak makası
Baby nail scissors
8.5 cm



SPENCER
EC640-00-EC640-01
Ligatür makası
Ligature scissors



LITAUER
EC642-00
Ligatür makası
Ligature scissors
13.5 cm

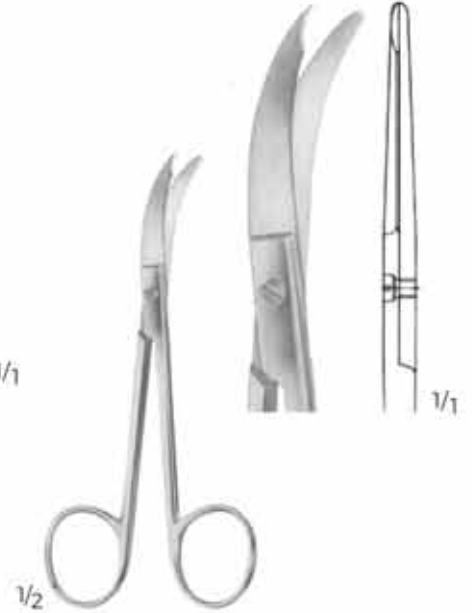

NORTHBENT
EC643-00
Ligatür makası
Ligature scissors
12 cm



BEEBE
EC661-00-EC665-00
11 cm



EC661-00 EC662-00



EC663-00
Geniş ağız bleyd
Broad blades



EC664-00
Tek ağız tırtilli
One jaw serrated



HARVEY
EC666-00
Çift ağız tırtilli
Both jaws serrated
12.5 cm



EC668-00
Tek ağız tırtilli
One jaws serrated
12 cm



Karbür kesme ucu yerleştirilmiş HARDTIPS makaslar

- Mükemmel kesim
- Uzun çalışma ömrü

HARDTIPS scissors with inserted carbide cutting edges

- Excellent Cutting
- Long working

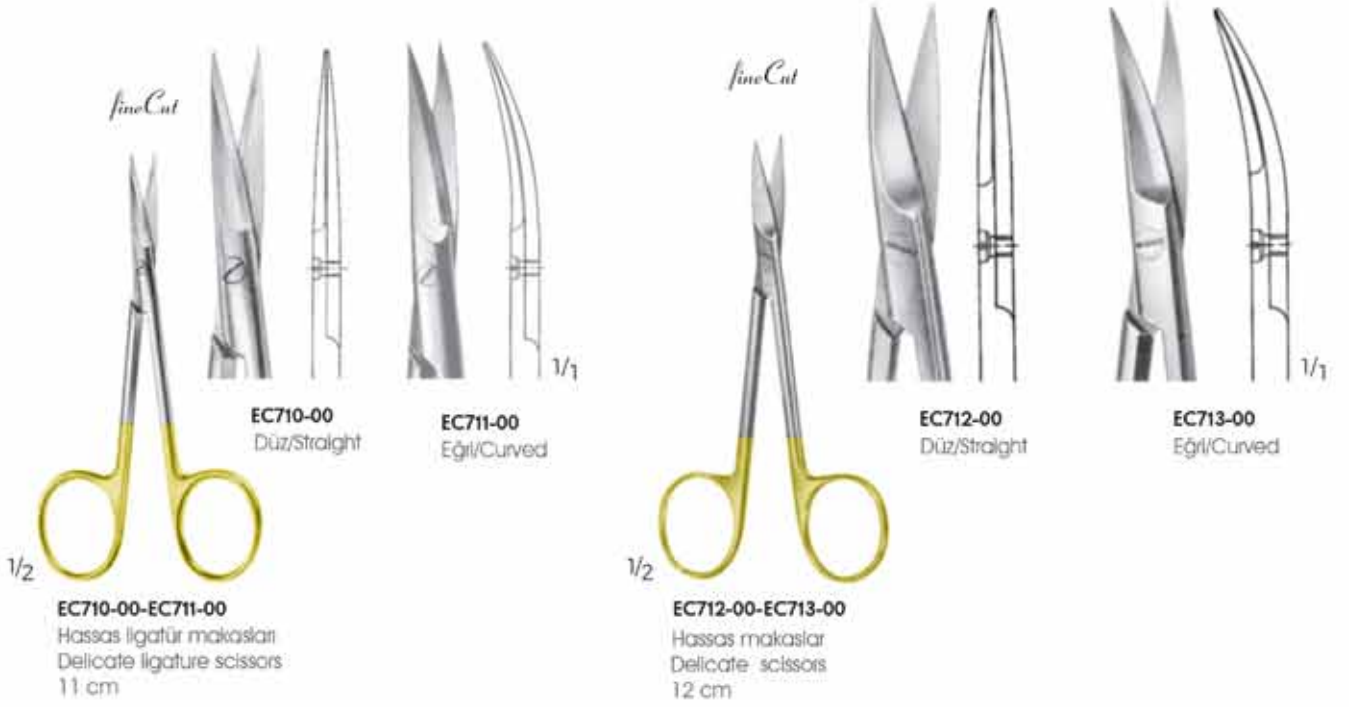

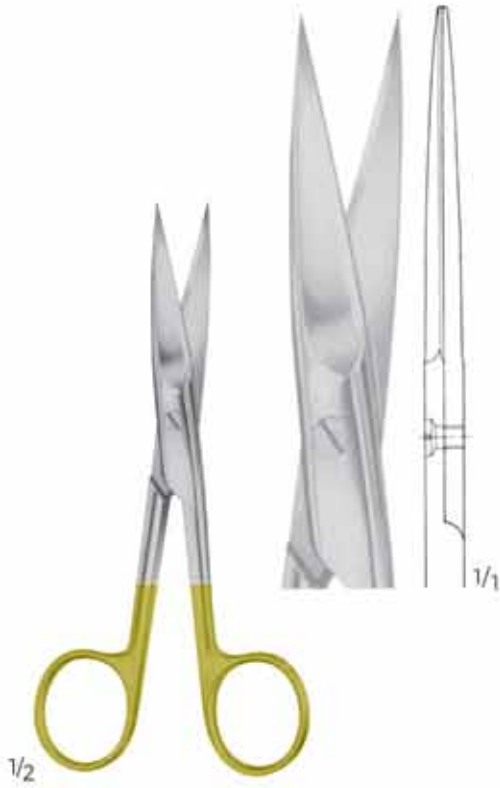

EC722-00
 Cerrahi makas/Surgical scissors
 14.5 cm

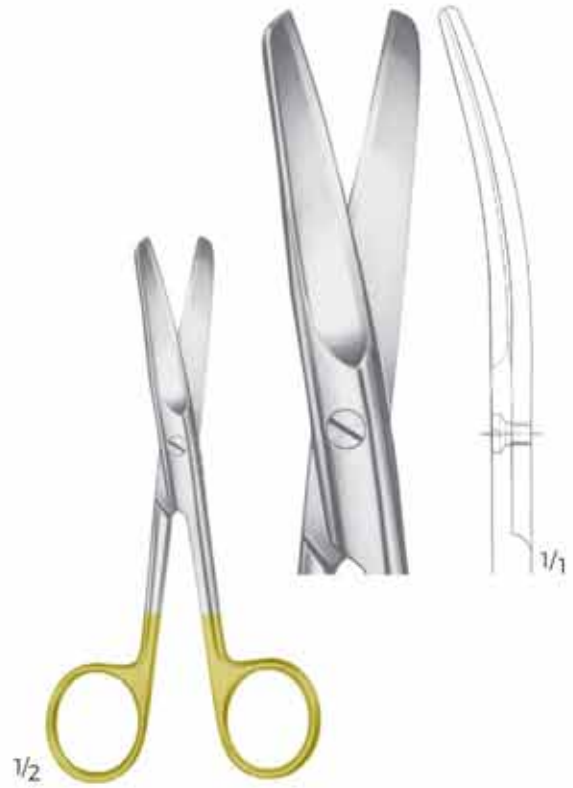

EC723-03
 Cerrahi makas/Surgical scissors
 14.5 cm

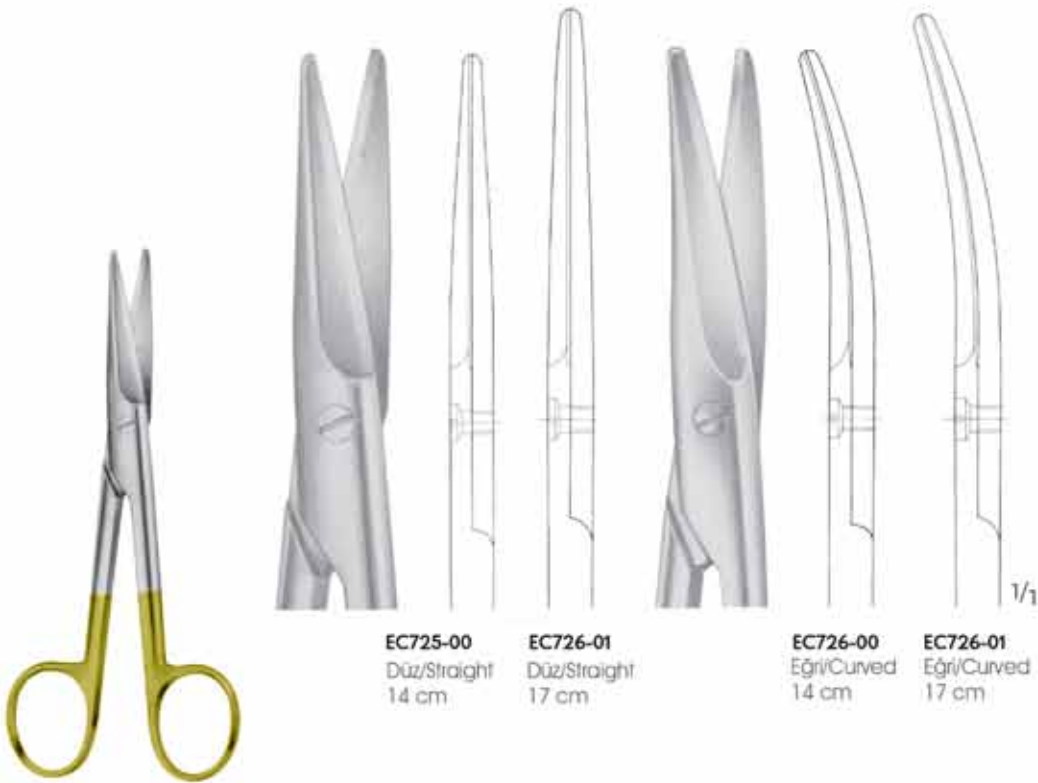

MAYO
EC725-00-EC726-01
 Diseksiyon makasları/Dissecting scissors



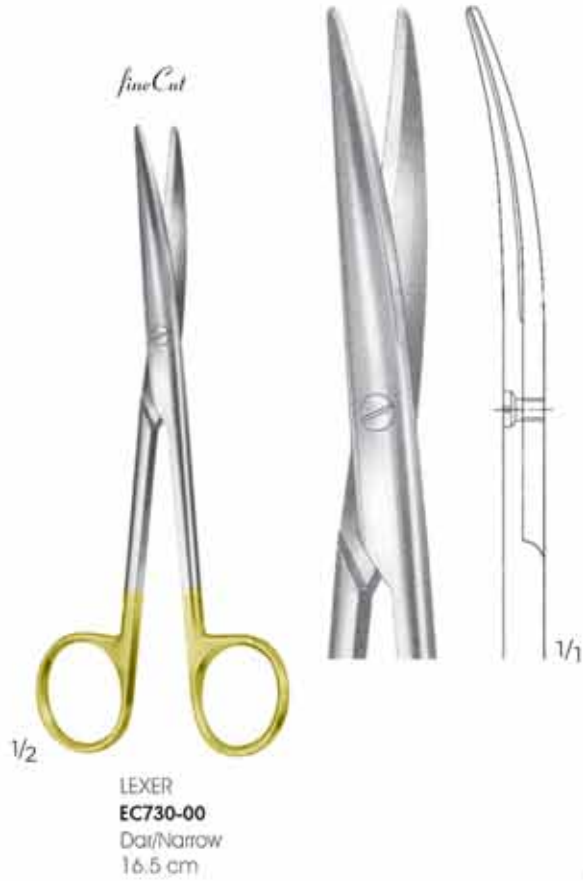



EC738-00 23 cm
EC738-10 35 cm

WERTHEIM
EC738-00-EC738-10
 Diseksiyon makasları/Dissecting scissors

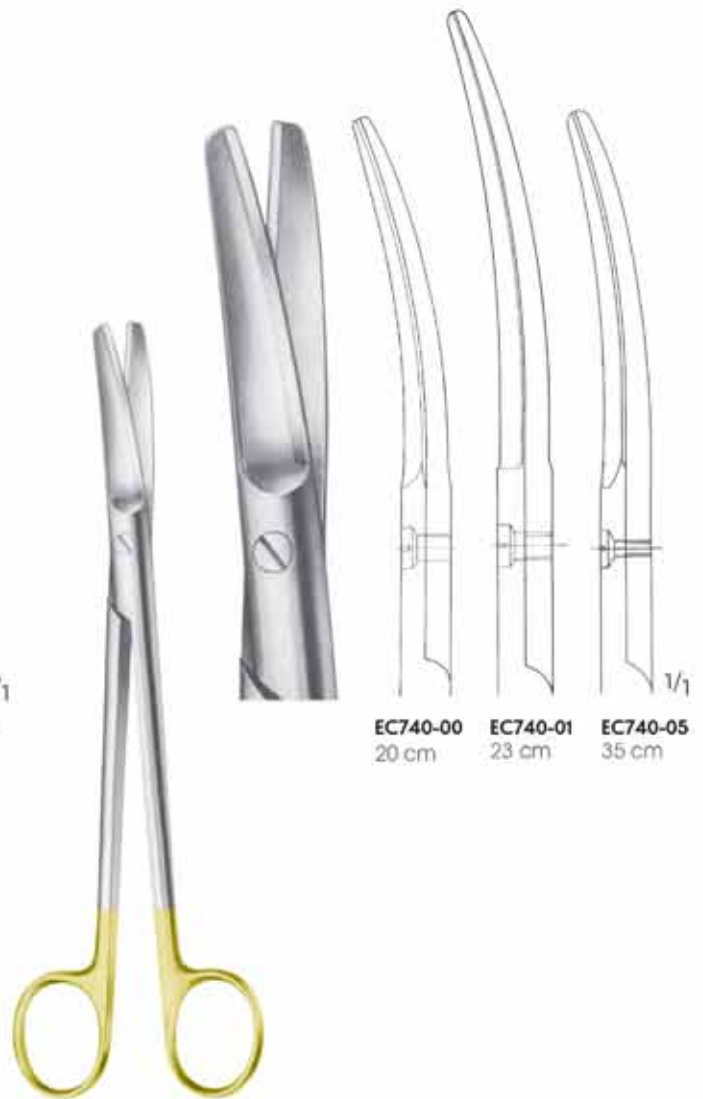

EC740-00 20 cm
EC740-01 23 cm
EC740-05 35 cm

SIMS
EC740-00-EC740-05
 Rahim makasları/Uterine Scissors



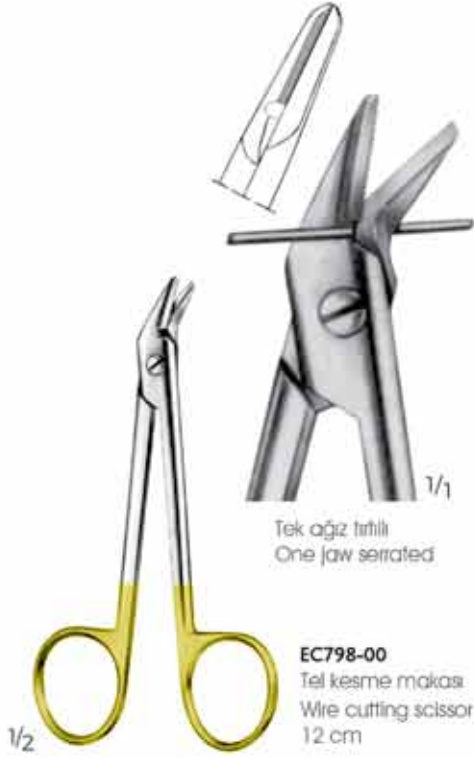





NELSON-METZENBAUM
EC768-00-EC768-02



EC768-00
26 cm



EC768-01
28 cm



EC768-02
28.5 cm



NELSON-METZENBAUM (MC INDOE)
EC760-00-EC761-01



EC760-00
23 cm



EC761-01
23 cm



EC761-01
30 cm



METZENBAUM
EC766-00
23 cm



Geniş bıyık ucu
Broad blade ends



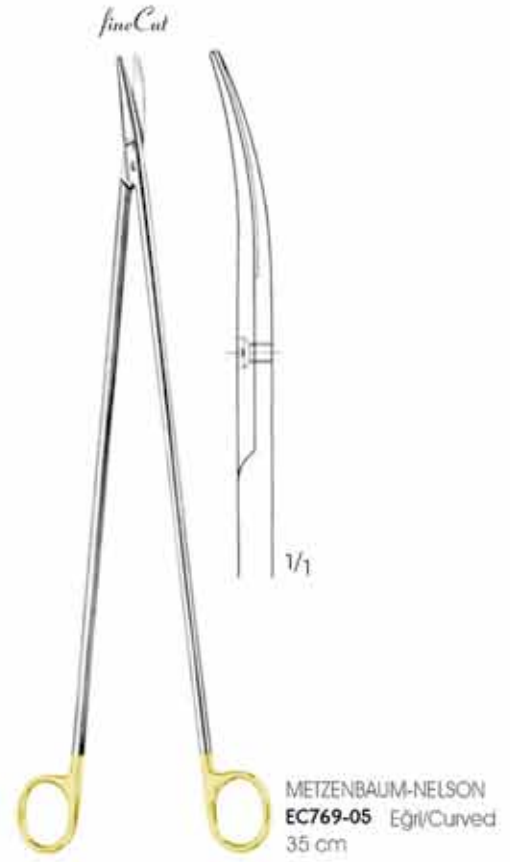
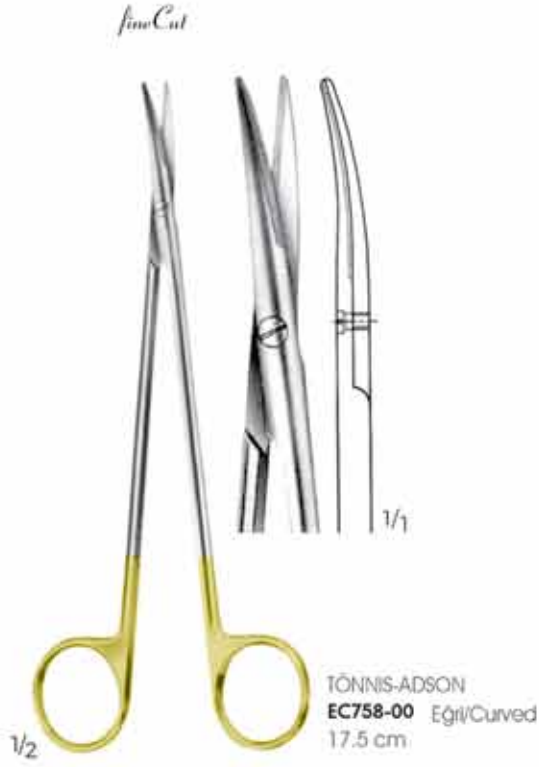



Dikiş malzemelerinin kesimi için ;

- GripCut makasın üzerindeki karbid uçları kalıcı keskinlik sağlar. (Makas ağzının uçları da dahil)
- GripCut makasın üzerindeki Tırtıklı ağız dikiş malzemelerinin dışarıya kaymasını engeller.

Cutting suture materials;

- Carbide inserts on GripCut scissors provide lasting sharpness. (including tip of the blades of the scissors)
- Serrated edges on GripCut scissors prevents suture materials from slipping out.



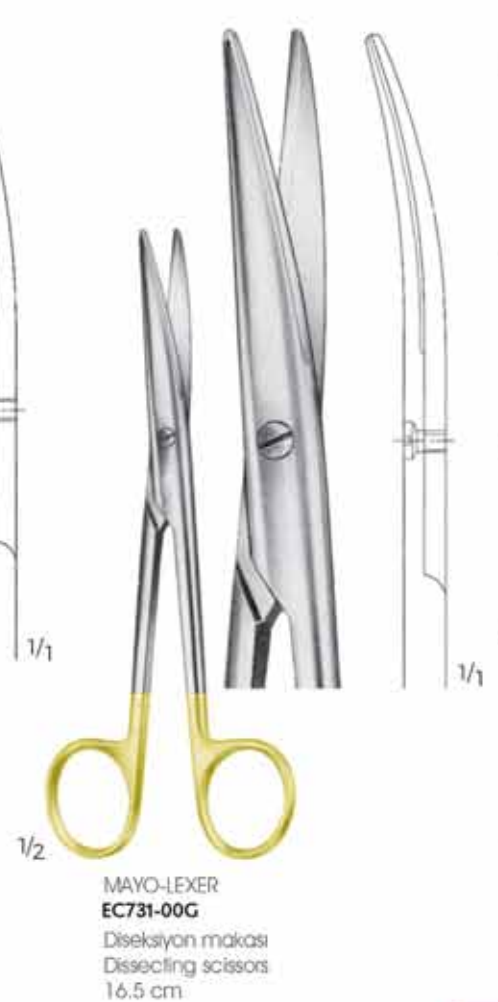
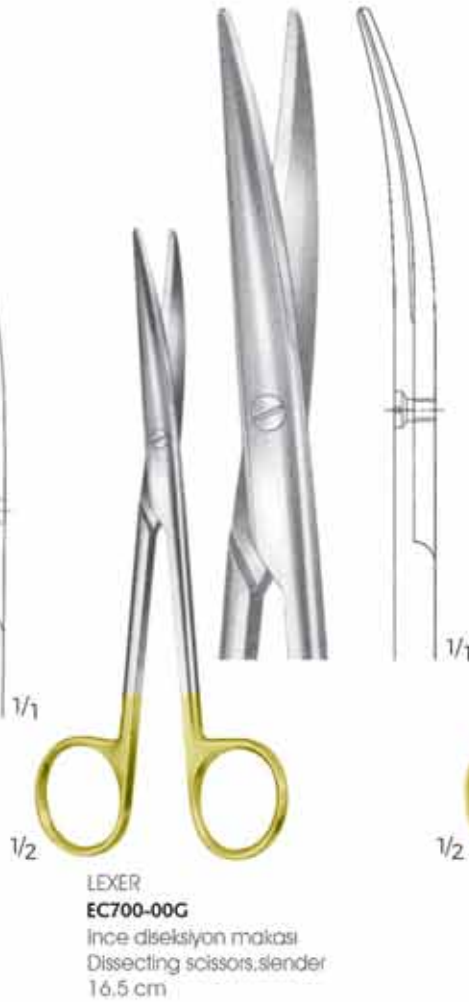
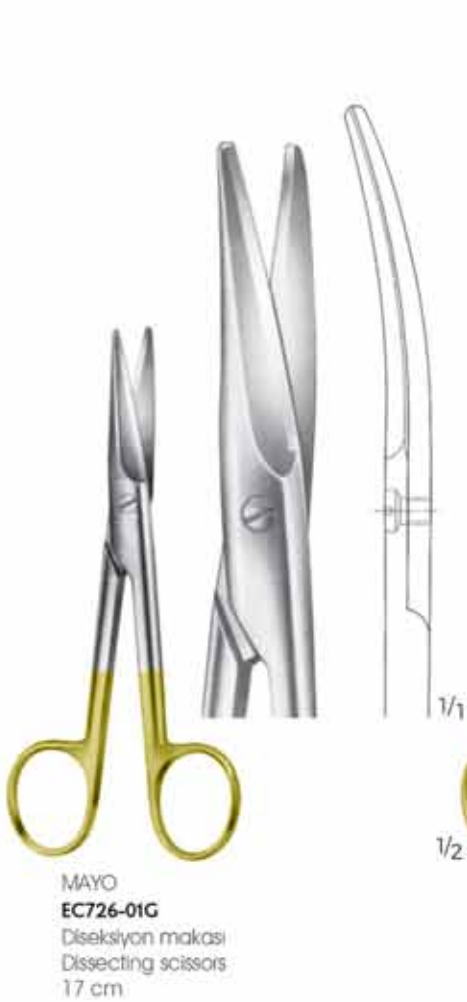

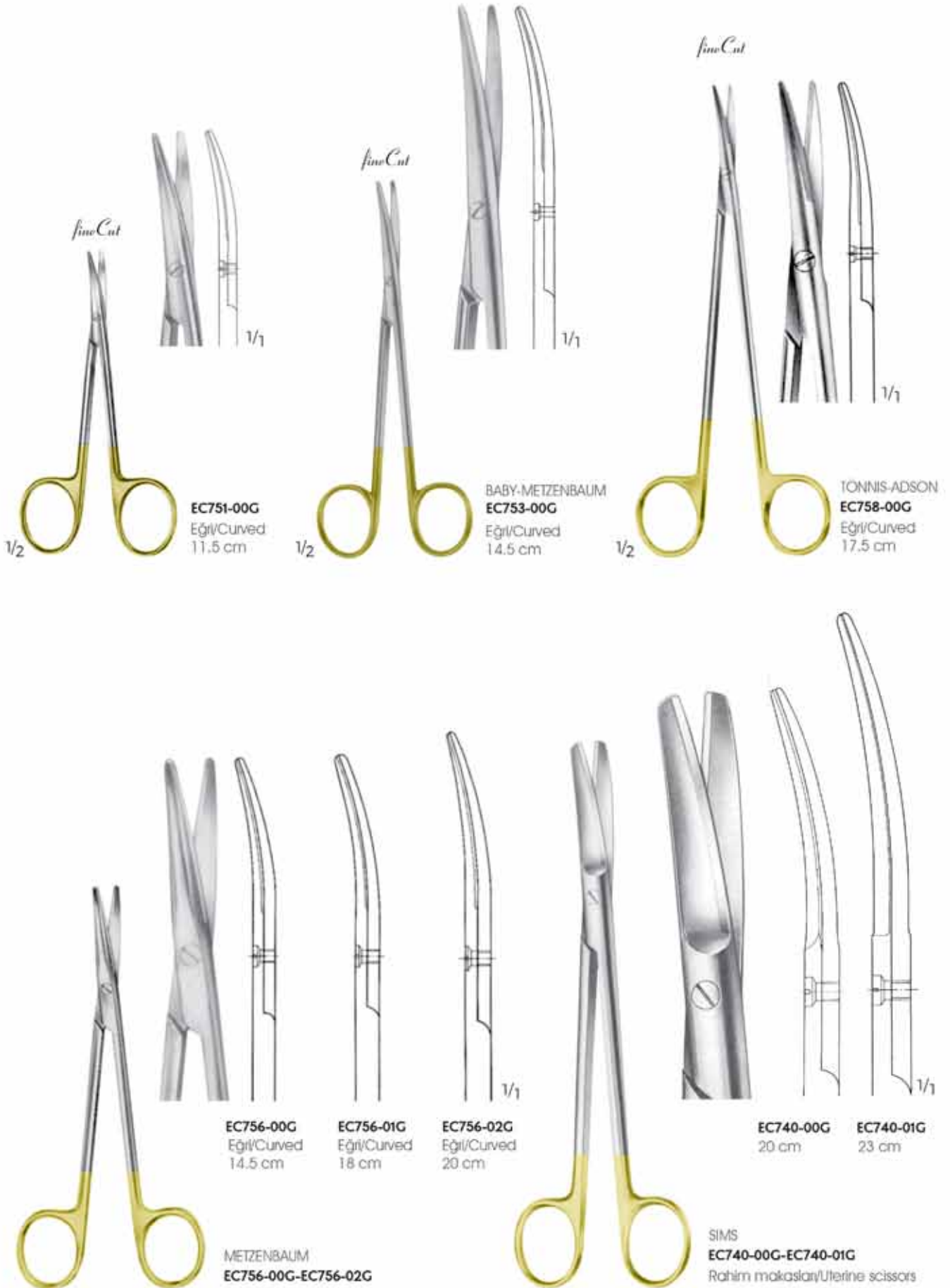





Dikiş malzemelerinin kesimi için ;

- *GripCut* makasın üzerindeki karbid uçları kalıcı keskinlik sağlar. (Makas ağzının uçları da dahil)
- *GripCut* makasın üzerindeki Tırtıklı ağız dikiş malzemelerinin dışarıya kaymasını engeller.

Cutting suture materials;

- Carbide inserts on *GripCut* scissors provide lasting sharpness. (including tip of the blades of the scissors)
- Serrated edges on *GripCut* scissors prevents suture materials from slipping out.

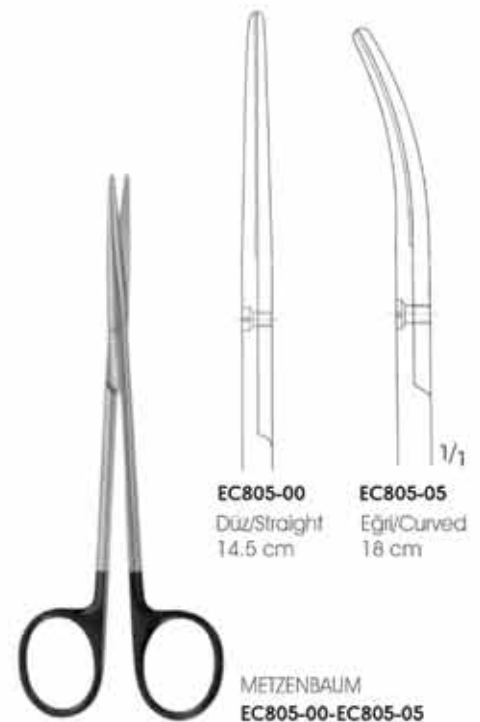

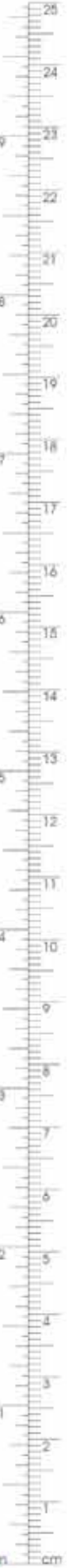

EC804-01
Düz/Straight

EC804-05
Eğri/Curved

JOSEPH
EC804-01-EC804-05
Sivri/Sharp
15 cm

1/2

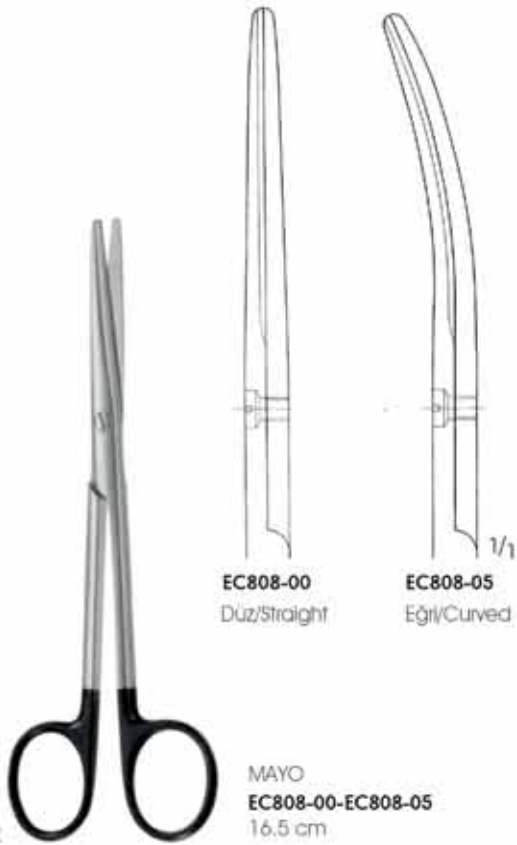

EC808-00
Düz/Straight

EC808-05
Eğri/Curved

MAYO
EC808-00-EC808-05
16.5 cm

1/2

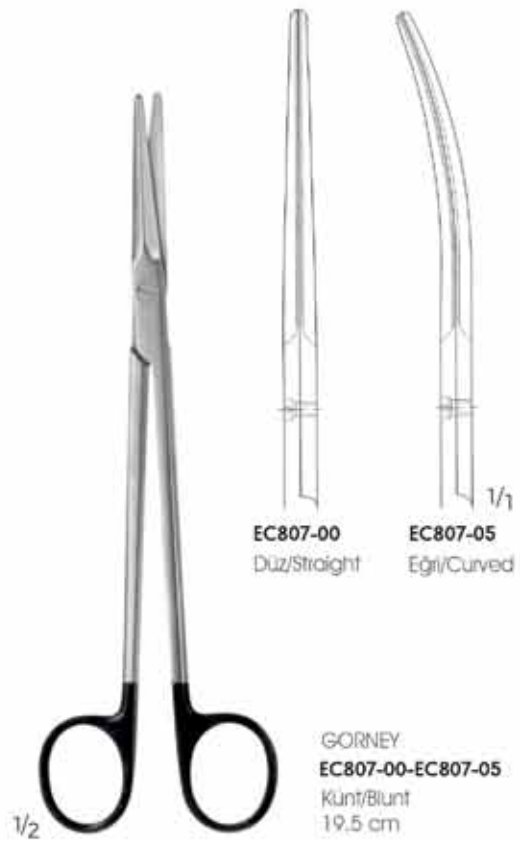

EC807-00
Düz/Straight

EC807-05
Eğri/Curved

GORNEY
EC807-00-EC807-05
Kütlü/Blunt
19.5 cm

1/2





GripCut kesme sırasında dokunun kaymasını engeller.

GripCut prevents tissue from slipping out during the cutting process

fineCut



EC790-01B
Tek ağız tırtıllı/One jaws serrated
11.5 cm

fineCut



EC792-01B
Tek ağız tırtıllı/One jaws serrated
14.5 cm

fineCut

fineCut



EC793-01B 14.5 cm
EC793-03B 18 cm
EC793-04B 20 cm
EC793-13B 18 cm
EC793-14B 20 cm

METZENBAUM
EC793-01B-EC793-14B
Tek ağız tırtıllı/One jaws serrated



EC795-01B 16.5 cm
EC795-02B 16.5 cm

MAYO-LEXER
EC795-01B-EC795-14B
Tek ağız tırtıllı/One jaws serrated



ED

Pensetler
Forceps

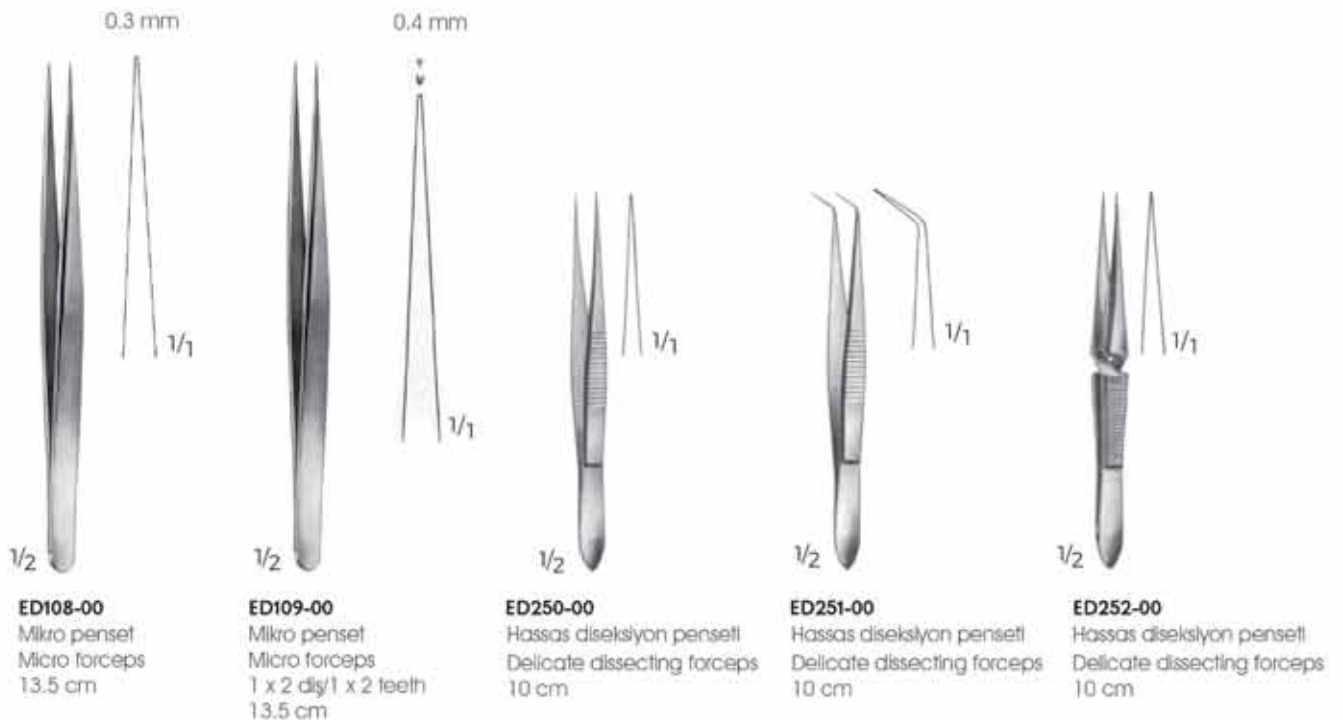
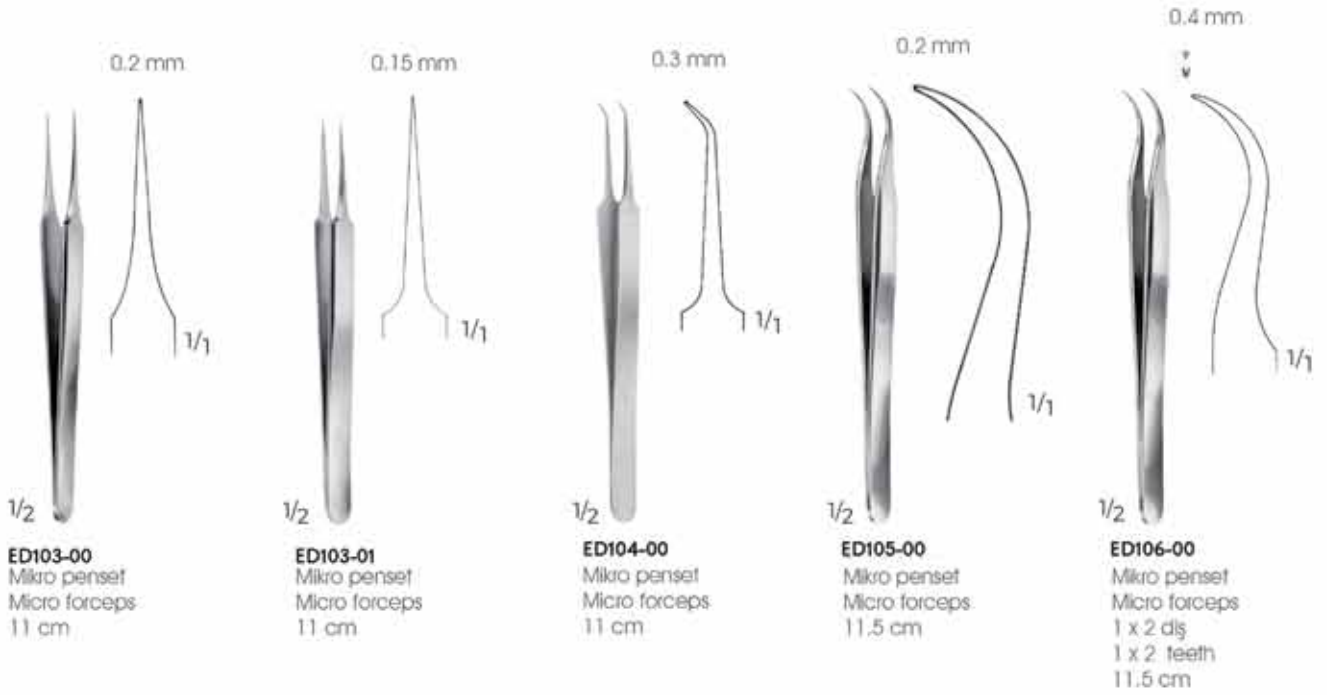

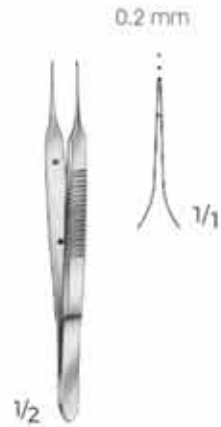

BONNER MODIFIED
ED124-00
1 x 2 dişli platform
With plateau 1 x 2 teeth
9.5 cm



ED107-00
12 cm



VISE
ED110-00
13.5 cm



VISE
ED113-00
13.5 cm

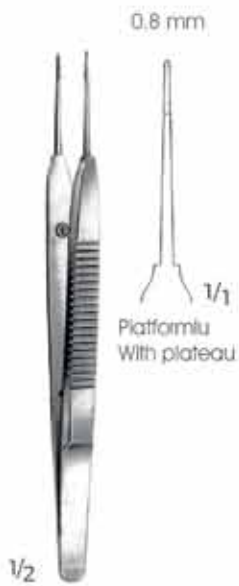

AUSTIN
ED125-00
14 cm

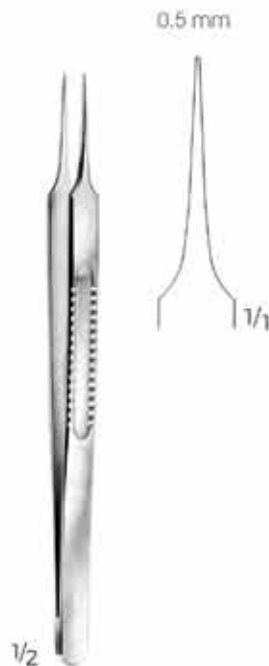

LAZAR
ED127-00
15.5 cm

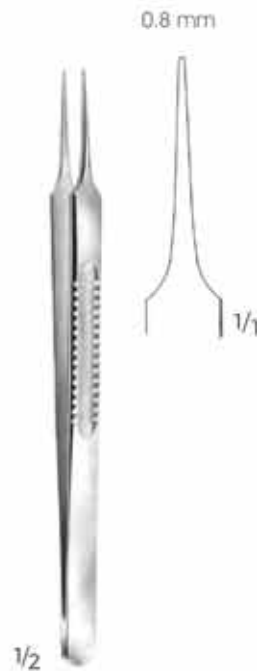

LAZAR
ED128-00
15.5 cm

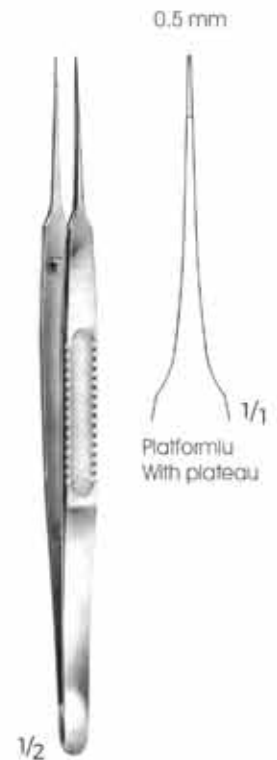

ED126-00
18.5 cm



Kavrama yüzeyini artıran hafif plastik tutamak :

- Kramp oluşturmeyan, doğal tutma pozisyonu ve duyarlılık sağlar.
- Yuvarlak tutma kesiti aletin kolay ve düzgün rotasyonunu sağlar. Böylelikle uygulama ve çalışma alanı genişler.
- Pimli tutma profili güvenli tutmayı garanti eder.
- Ergonomik, hafif plastik sap yorulmadan optimum kullanım sağlar.

Lightweigh plastic handles to increase grip surface:

- Provides cramp free ,natural holding positions and sensitivity
- Round cross-section of the instrument provides an easy and smooth rotation.Expands the working and application area.
- Retention profile with pin ensures safe gripping.
- Ergonomic, light weight plastic handle provides fatigue free, optimal usage.

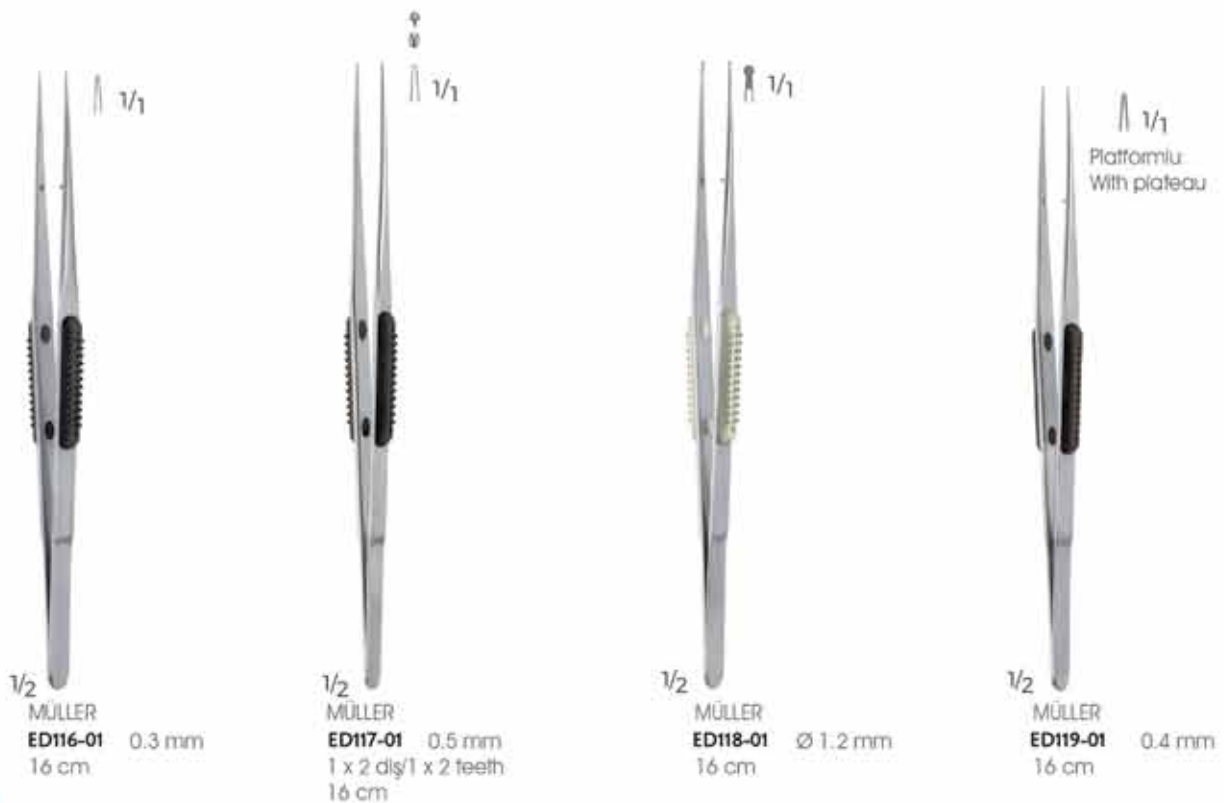
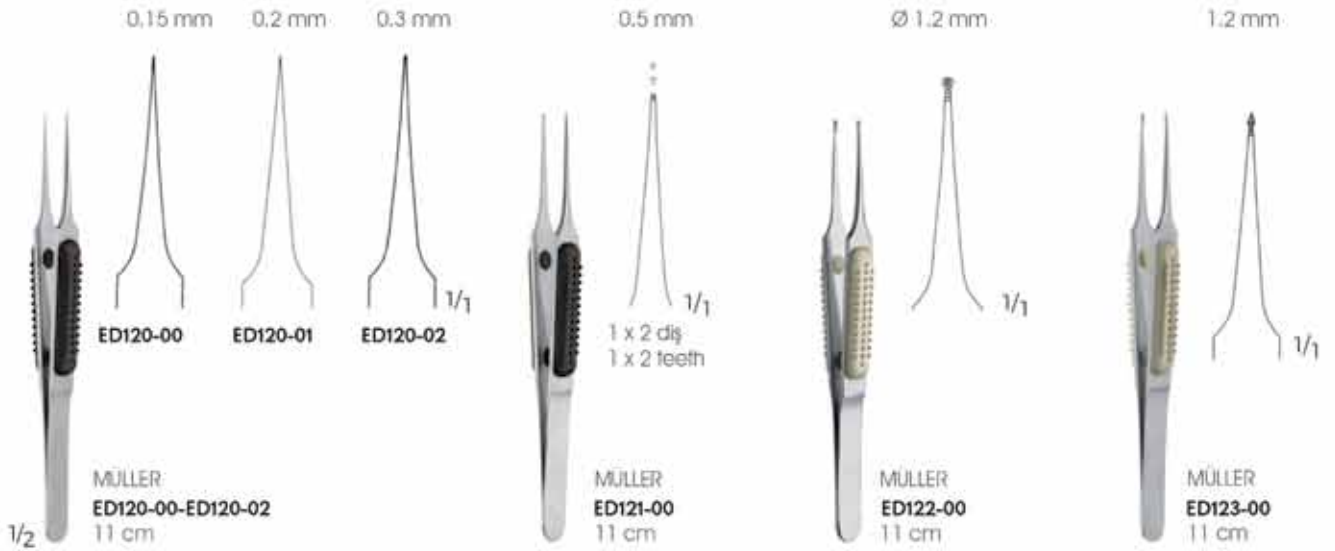

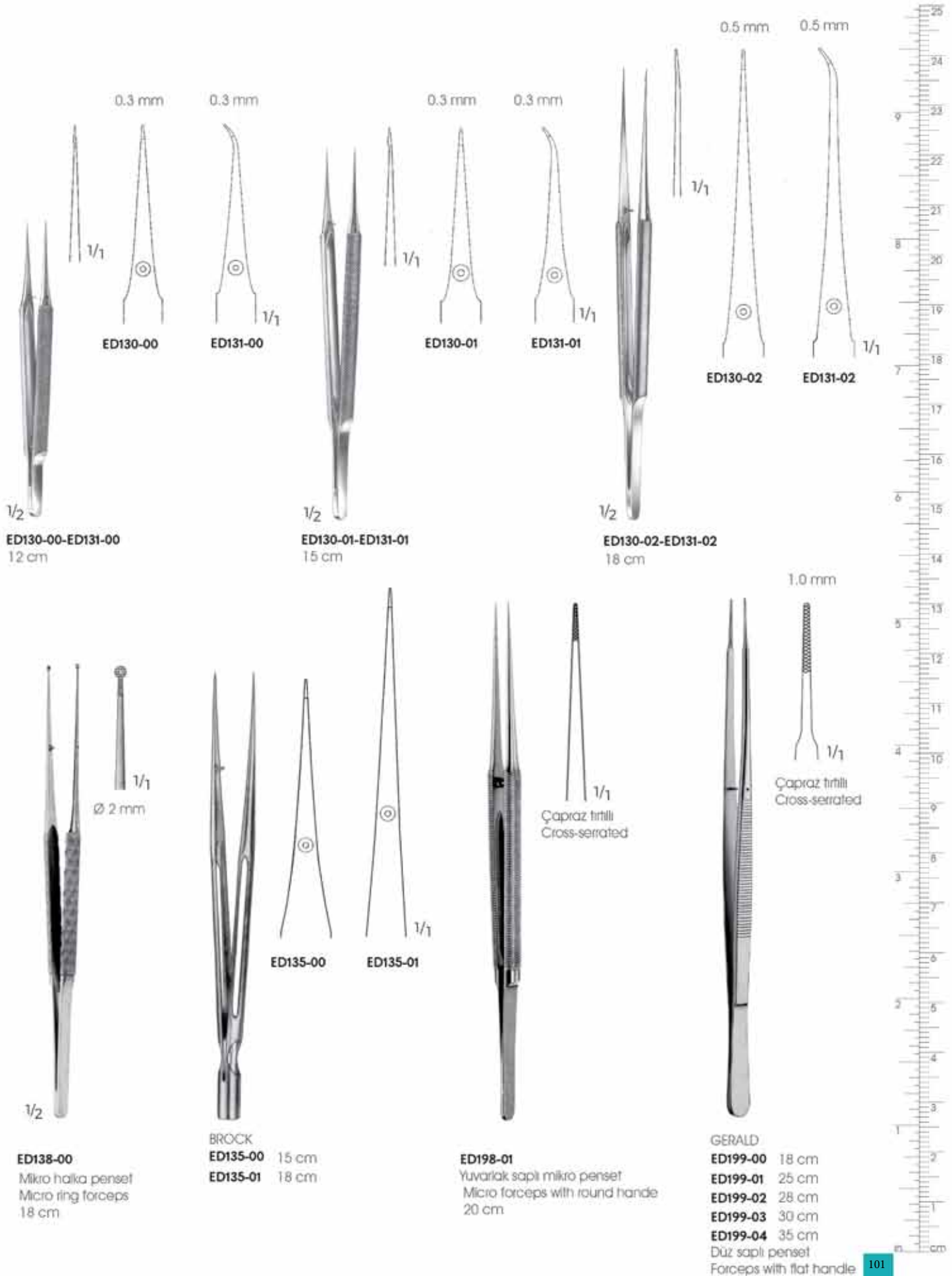

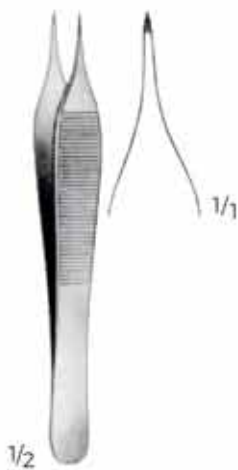

THORPE
ED203-00
Korneal penset
Corneal forceps
12 cm



MICRO-ADSON
ED204-00
12 cm

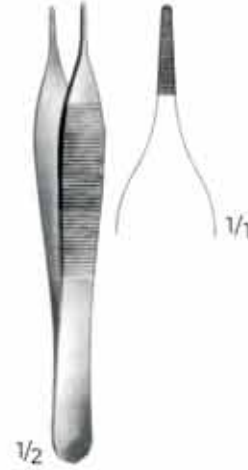

ADSON
ED205-00
12 cm



HUDSON
ED206-00
12.5 cm



MICRO-ADSON
ED207-00
15 cm



ADSON
ED213-00
18 cm



JEFFERSON
ED214-00
18 cm

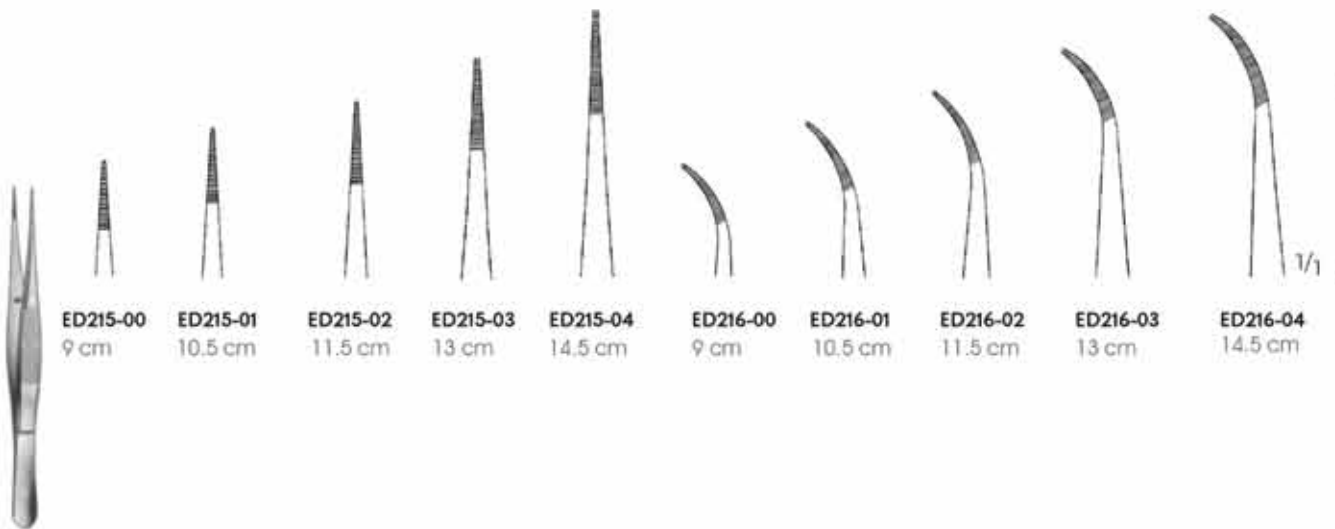
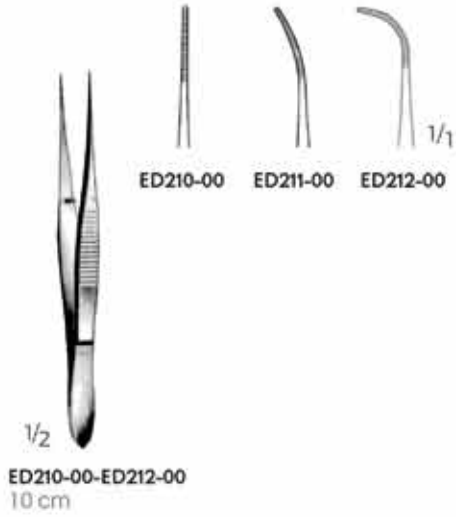

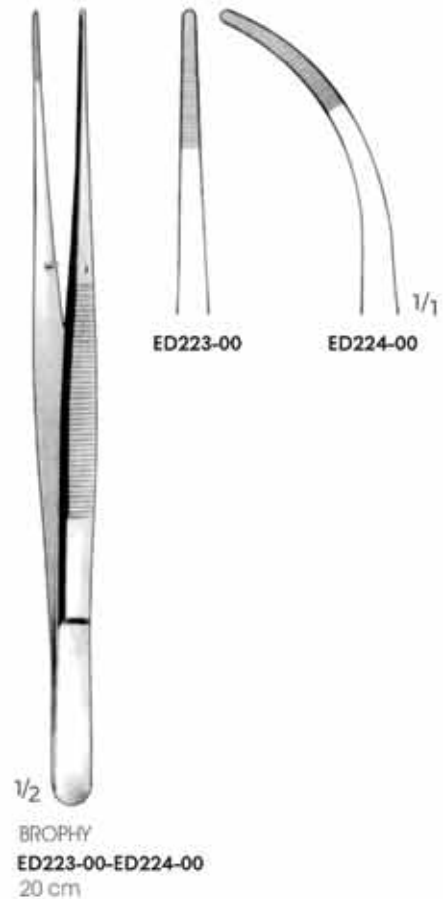
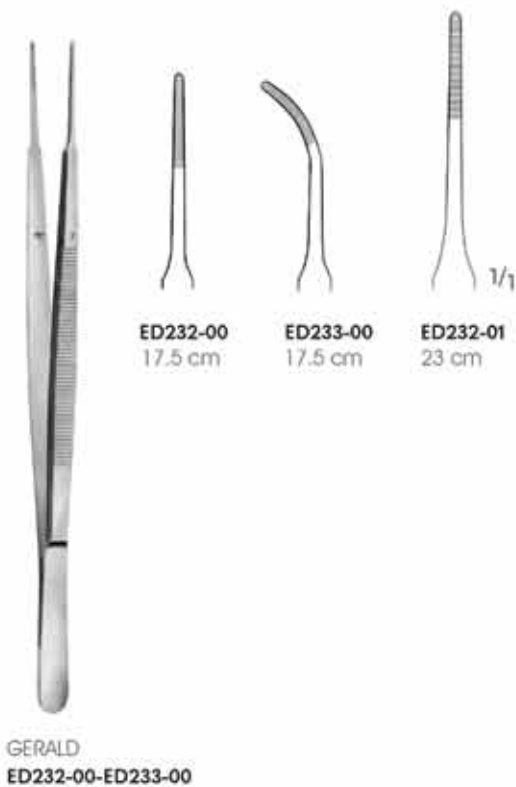
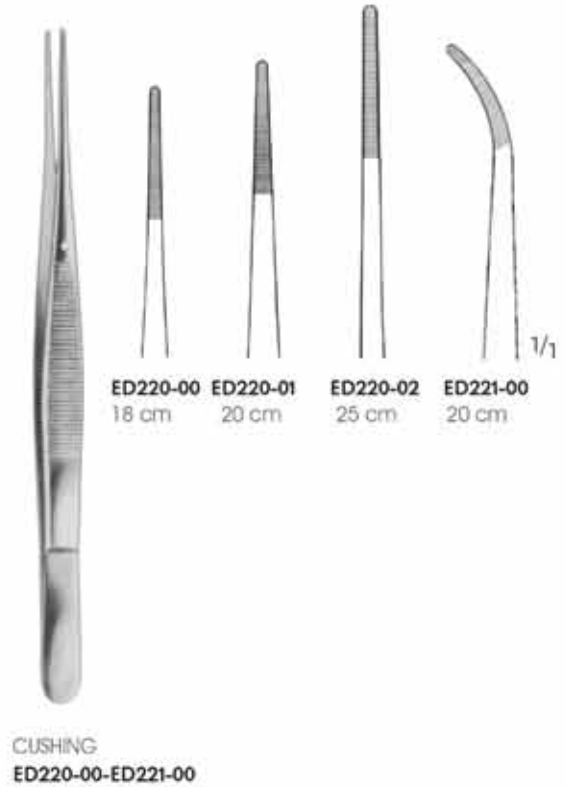

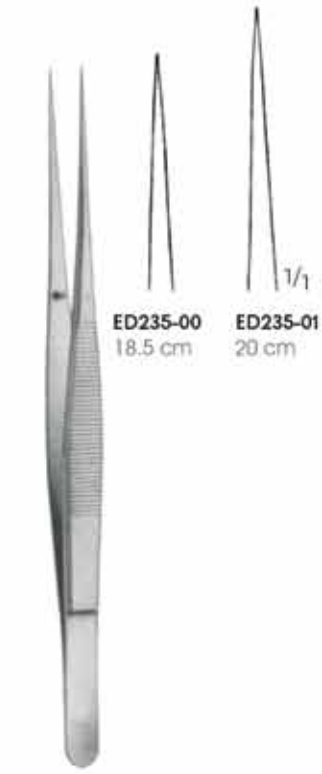

ED235-00
18.5 cm

ED235-01
20 cm

ED235-00-ED235-01
Düz Ağız/Smooth jaws



1/2
COOLEY
ED222-00
20 cm



1/2
ED236-00
20 cm



1/2
MC INDOE
ED230-00
15 cm



ED239-00
17.5 cm

ED239-01
21.5 cm

CAIRNS-DOTT
ED239-00-ED239-01



1/2
ED238-00
20 cm



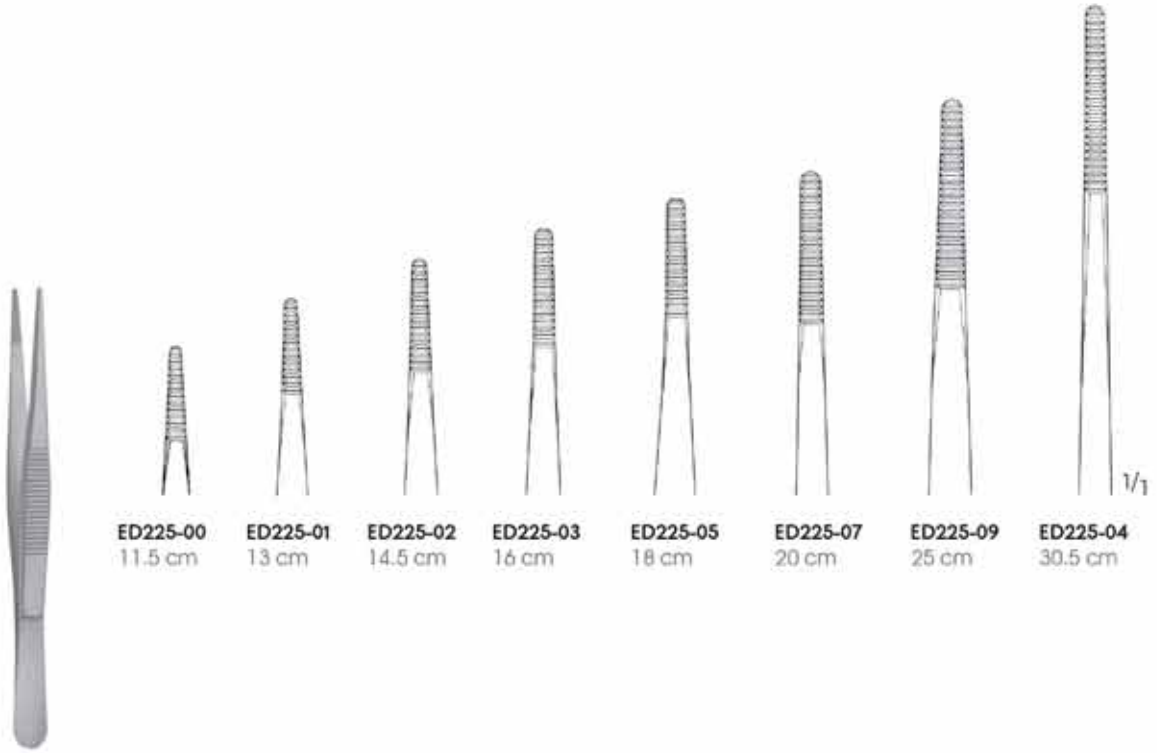

ED225-00 11.5 cm ED225-01 13 cm ED225-02 14.5 cm ED225-03 16 cm ED225-05 18 cm ED225-07 20 cm ED225-09 25 cm ED225-04 30.5 cm

ED225-00-ED235-09
Orta/Medium

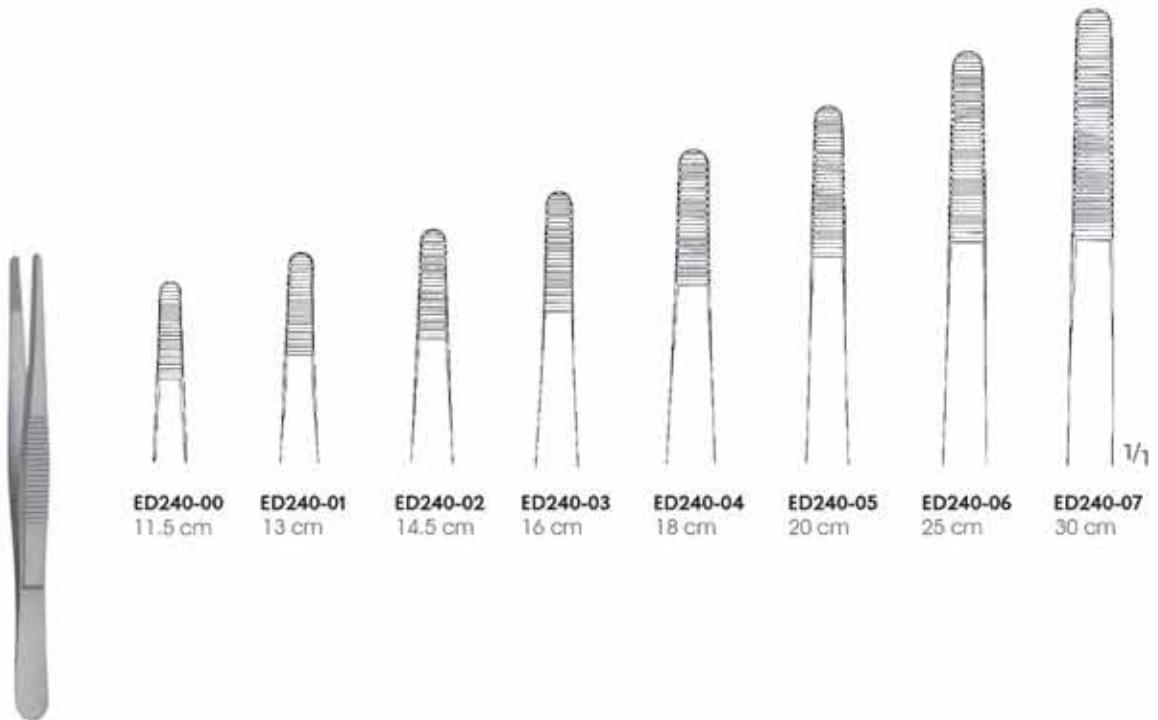

ED240-00 11.5 cm ED240-01 13 cm ED240-02 14.5 cm ED240-03 16 cm ED240-04 18 cm ED240-05 20 cm ED240-06 25 cm ED240-07 30 cm

ED240-00-ED240-07
Standart model/Standard pattern



ED242-00
Çok büyük/Extra Large
Diseksiyon penseti
Dissecting forceps
14.5 cm



OCHSNER
ED247-00
Ligatür penseti
Ligature forceps
14.5 cm

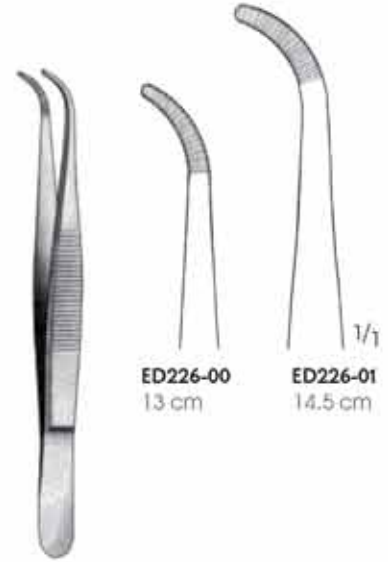

ED226-00-ED226-01
Orta/Medium
Diseksiyon pensetleri
Dissecting forceps

ED226-00
13 cm

ED226-01
14.5 cm

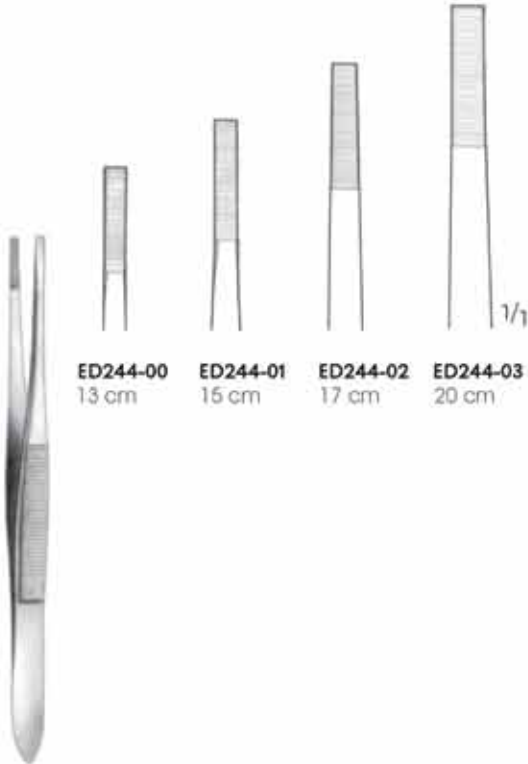

ED244-00
13 cm

ED244-01
15 cm

ED244-02
17 cm

ED244-03
20 cm

SCHWEDISCHES MODELL
ED244-00-ED244-03
Diseksiyon pensetleri
Dissecting forceps



BONNEY
ED248-00
Diseksiyon penseti
Dissecting forceps
17.5 cm



RAMSEY
ED245-00
Diseksiyon penseti
Dissecting forceps
18 cm





De Bakey Diş



Toothing De Bakey



DE BAKEY
ED257-00 15 cm
ED257-01 18.5 cm
ED257-02 21 cm
Yuvarlak Saplı
Mikro pensefeler
Micro forceps
With round handle



DE BAKEY
ED258-03 18.5 cm
ED258-04 21 cm
Yuvarlak saplı
Mikro pensefeler
Micro forceps
With round handle



DE BAKEY
ED256-01 18 cm
ED256-02 20 cm
Düz saplı
Mikro pensefeler
Micro forceps
With round handle

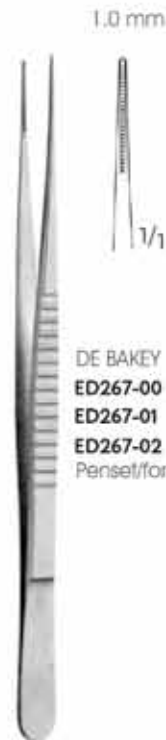

DE BAKEY
ED267-00 15 cm
ED267-01 19.5 cm
ED267-02 24 cm
Pensefeler/forceps



ED261-00 15 cm
ED261-03 19.5 cm
ED261-05 24 cm

COOLEY
ED261-00-ED261-05
Pensefeler/forceps



DE BAKEY
ED268-00 15 cm
Pensefeler/forceps

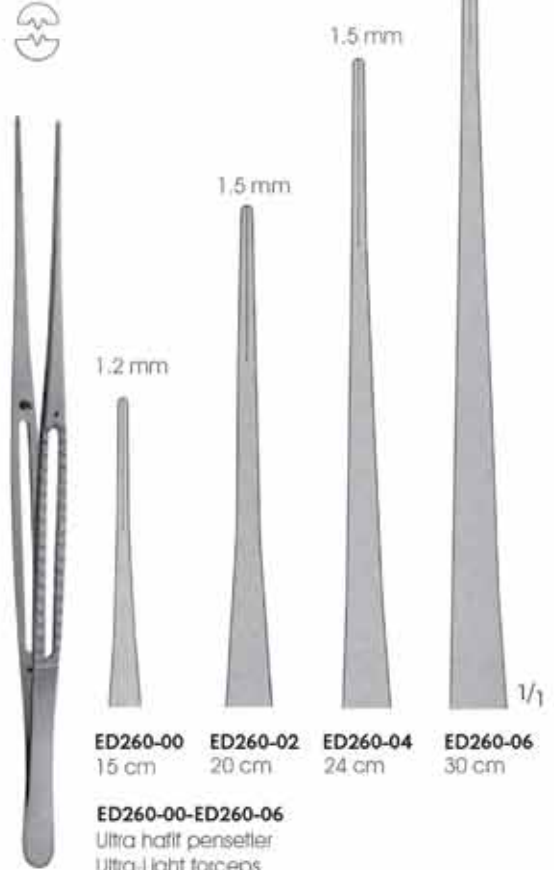

ED260-00 15 cm
ED260-02 20 cm
ED260-04 24 cm
ED260-06 30 cm

ED260-00-ED260-06
Ultra hafif pensefeler
Ultra-Light forceps

De Bakey Diş



Toothing De Bakey

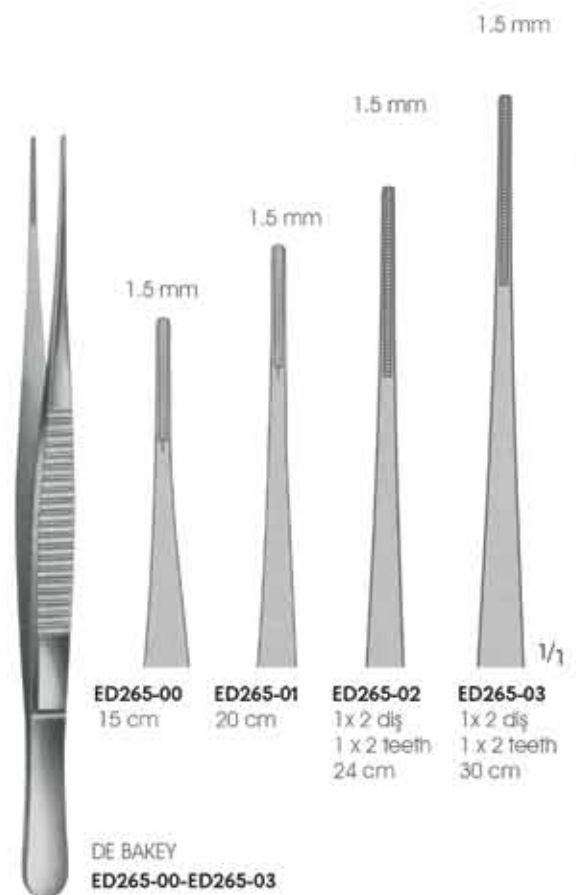
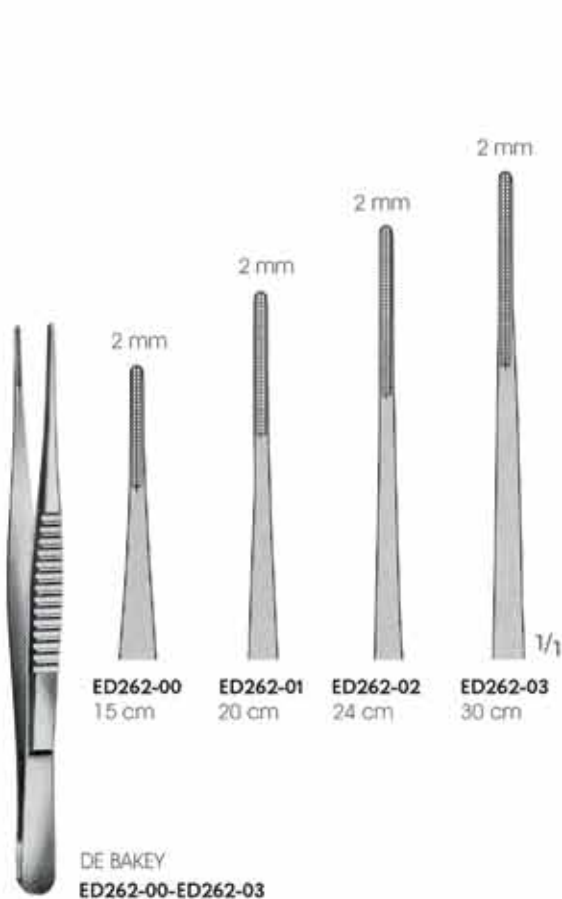
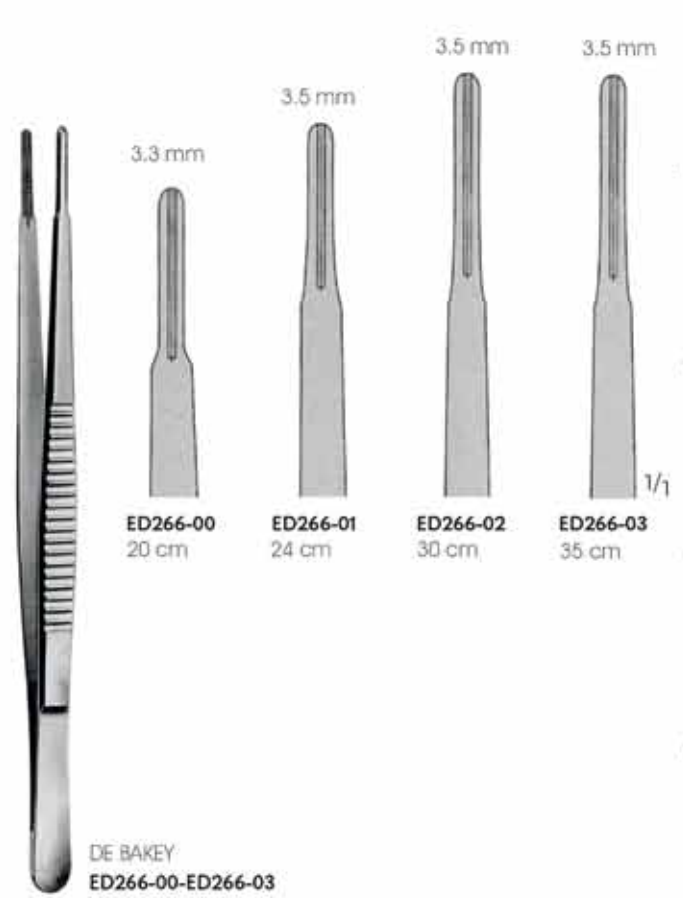
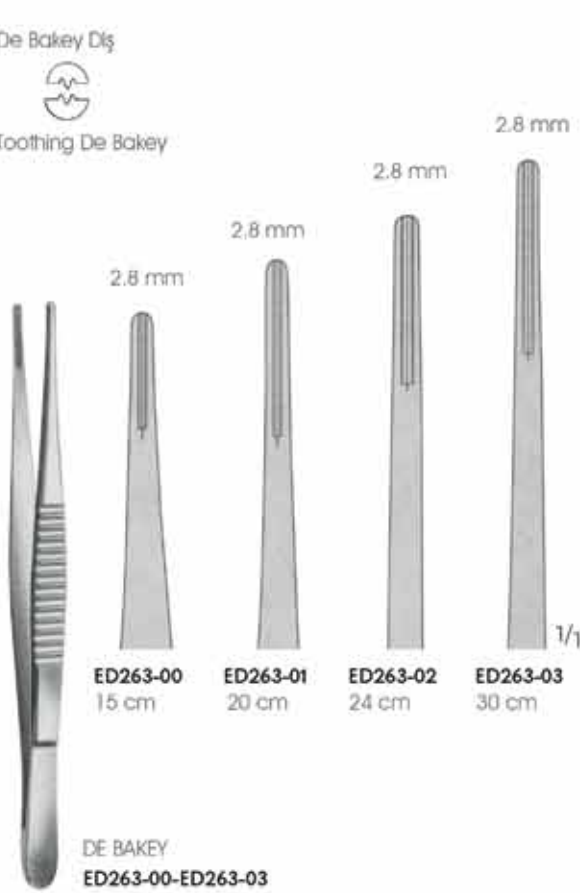

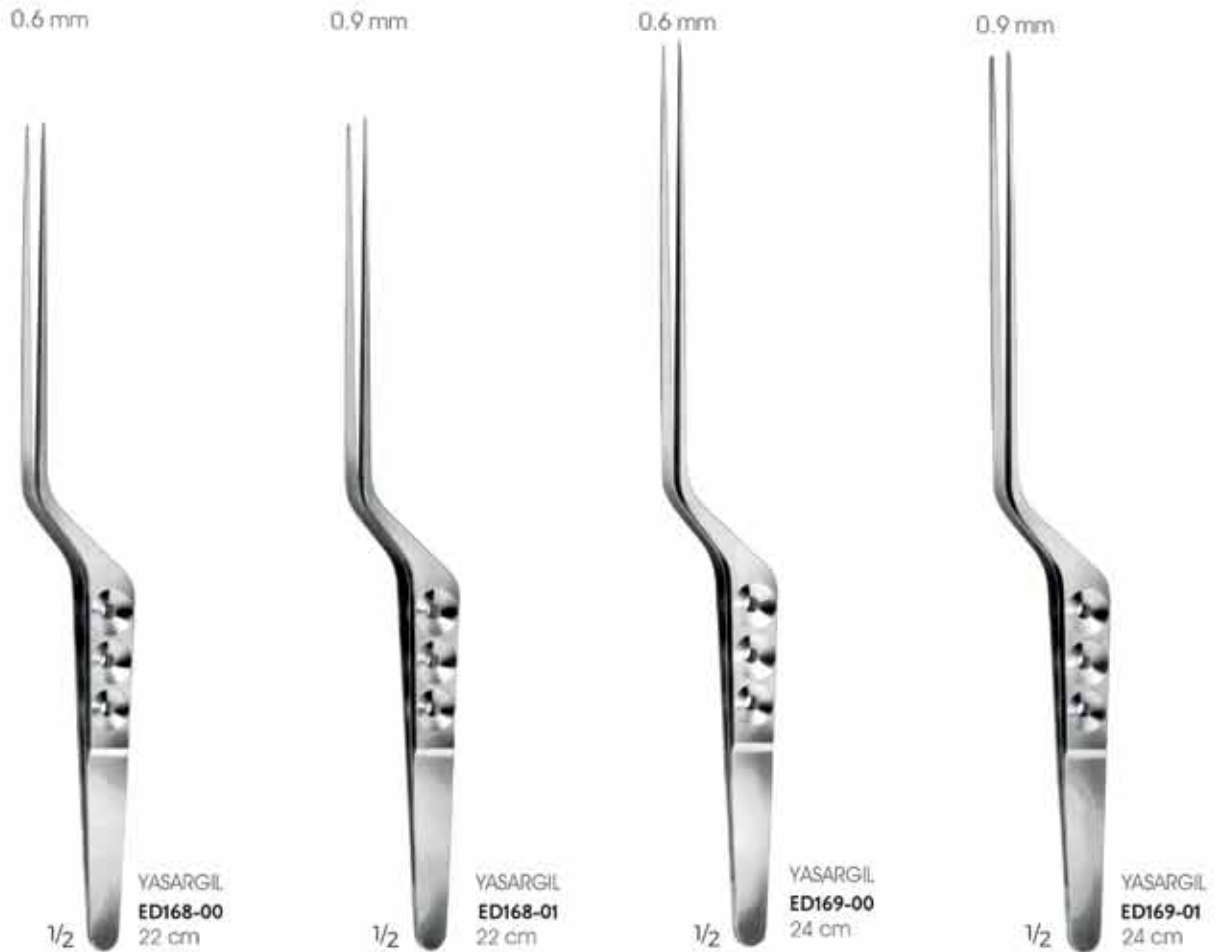



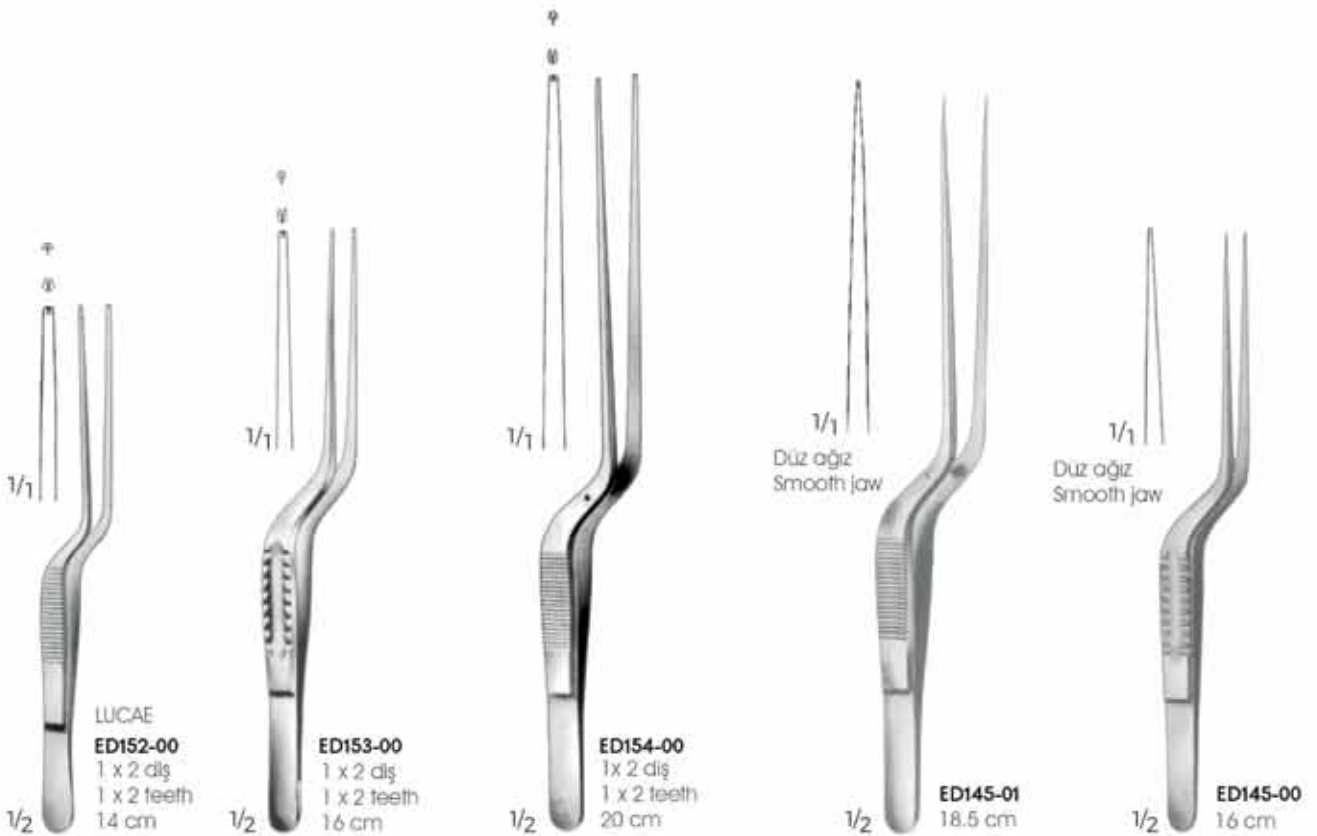





BISHOP-HARMON
ED018-00
Hassas göz pensefi
Delicate eye forceps
8.5 cm



ST. MARTIN
ED017-00
Hassas göz pensefi
Delicate eye forceps
8 cm



CASTROVIEJO
ED024-04
Hassas göz pensefi
Delicate eye forceps
10 cm



MICRO-ADSON-BIEMER
ED320-00
Hassas doku pensefi
Delicate tissue forceps
12 cm

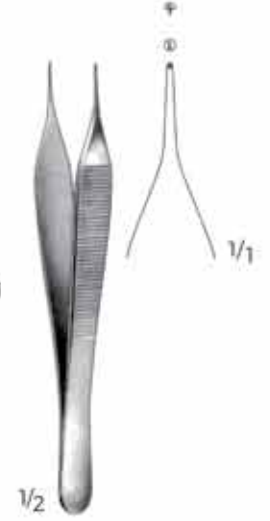

MICRO-ADSON
ED322-00
Hassas doku pensefi
Delicate tissue forceps
12 cm

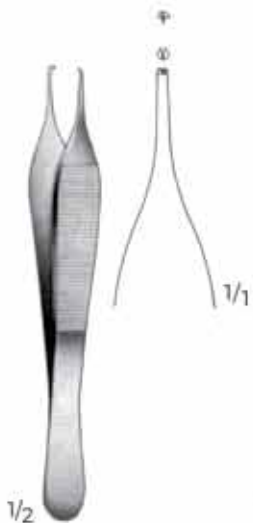

ADSON
ED323-00
Hassas doku pensefi
Delicate tissue forceps
12 cm



ADSON
ED324-00
Hassas doku pensefi
Delicate tissue forceps
12 cm



HUDSON
ED321-00
Doku pensefi
Tissue forceps
12.5 cm



ADSON
ED328-00
Doku pensefi
Tissue forceps
12 cm



MICRO-ADSON
ED327-00
Hassas doku pensefi
Delicate tissue forceps
15 cm

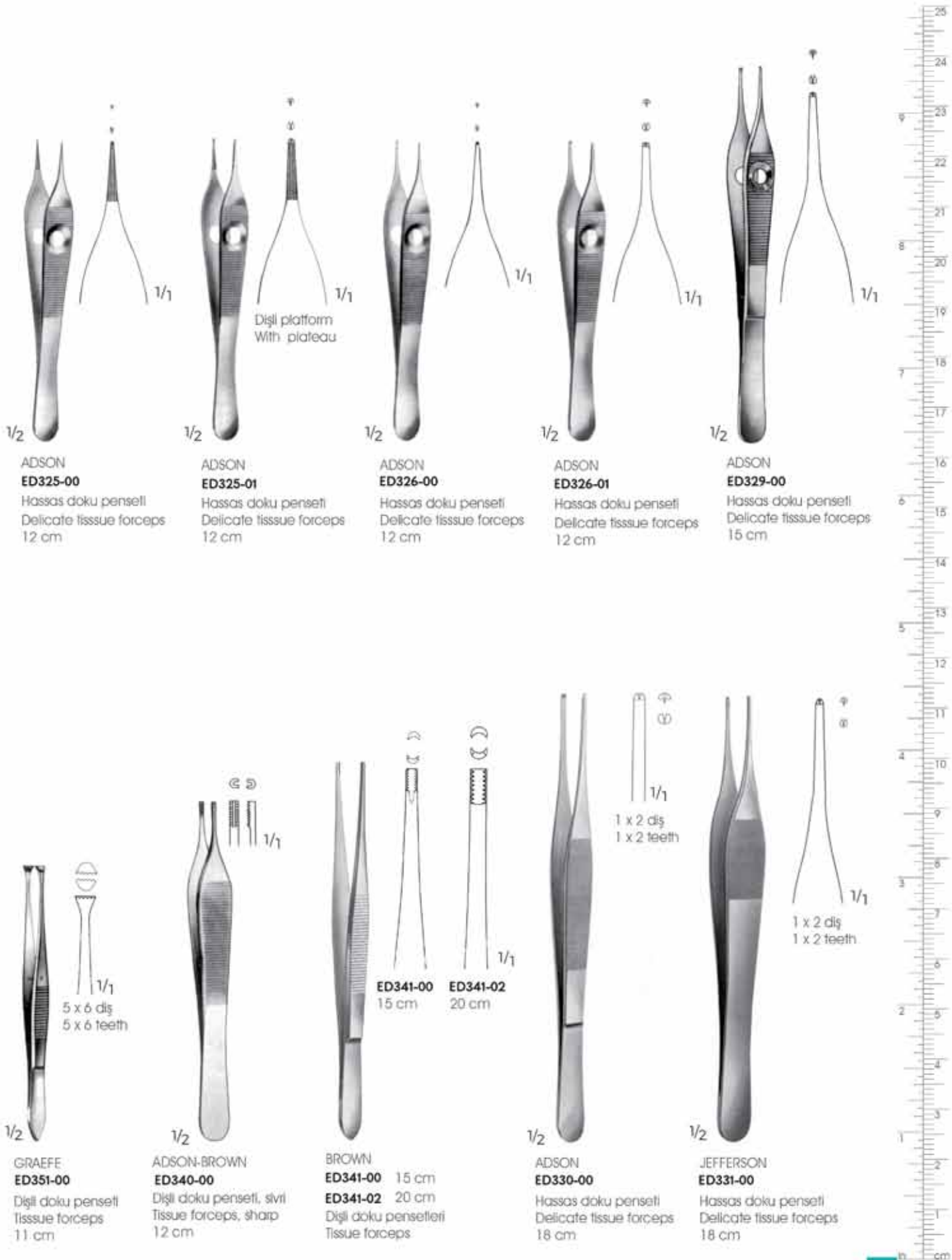

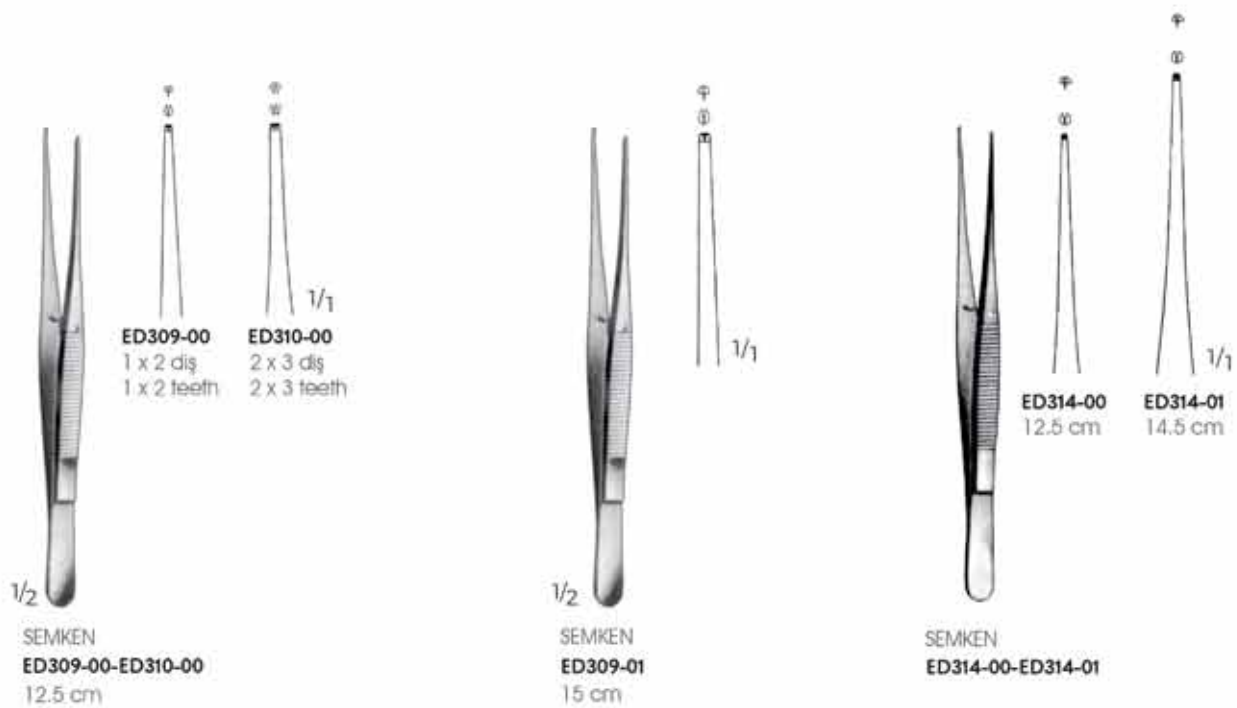
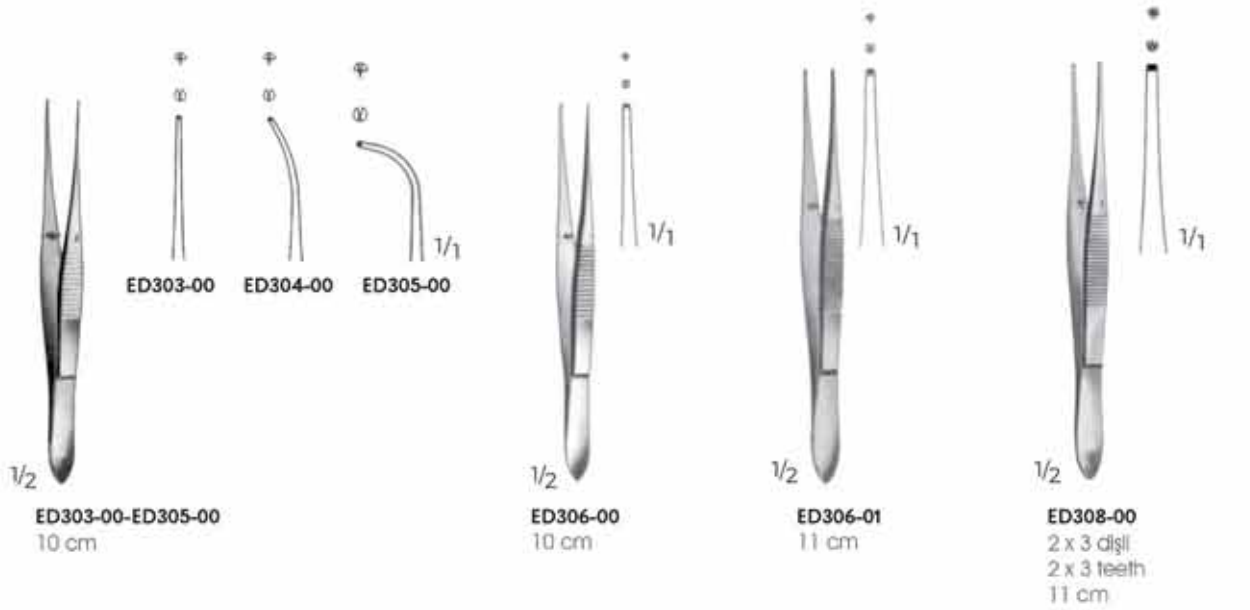

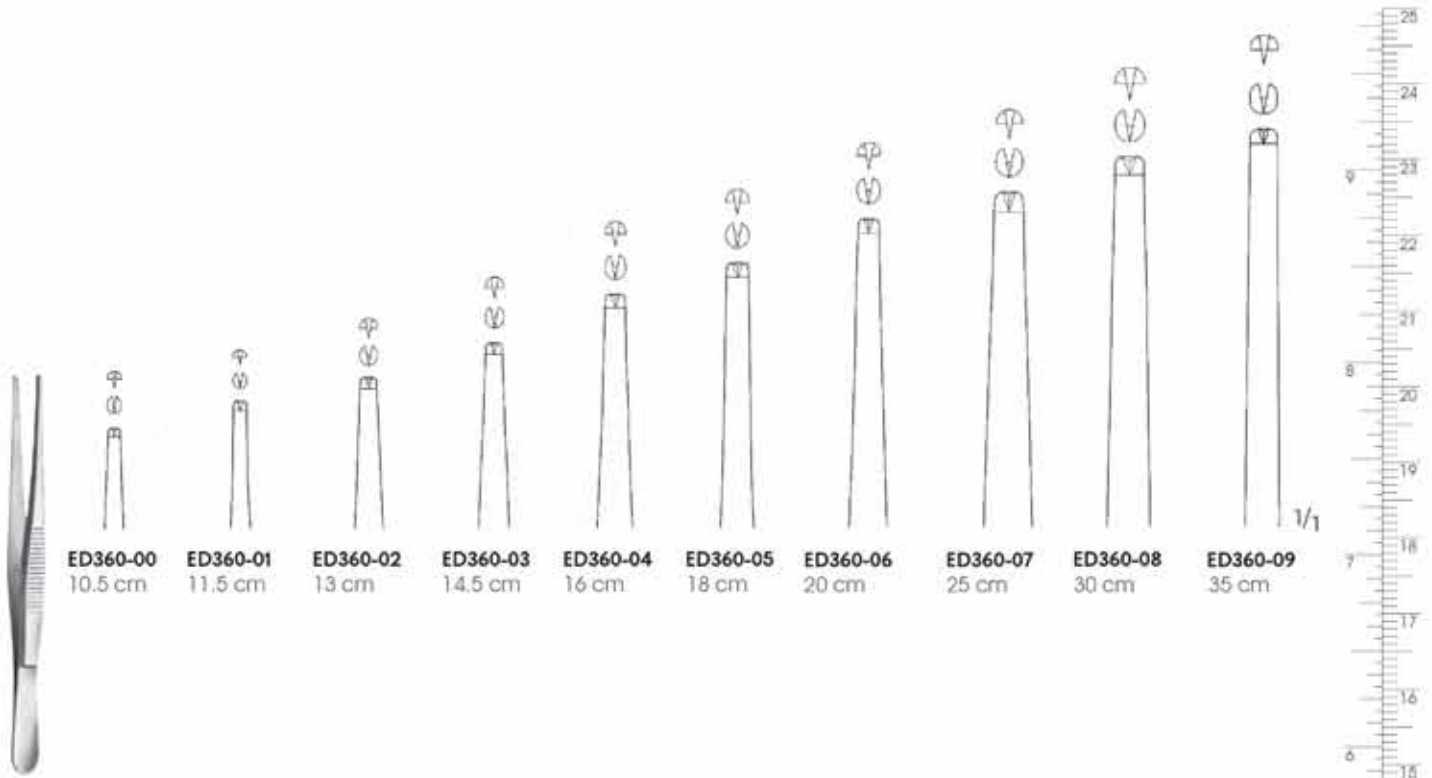

ED360-00-ED360-09
Standard model
Standard Modelle

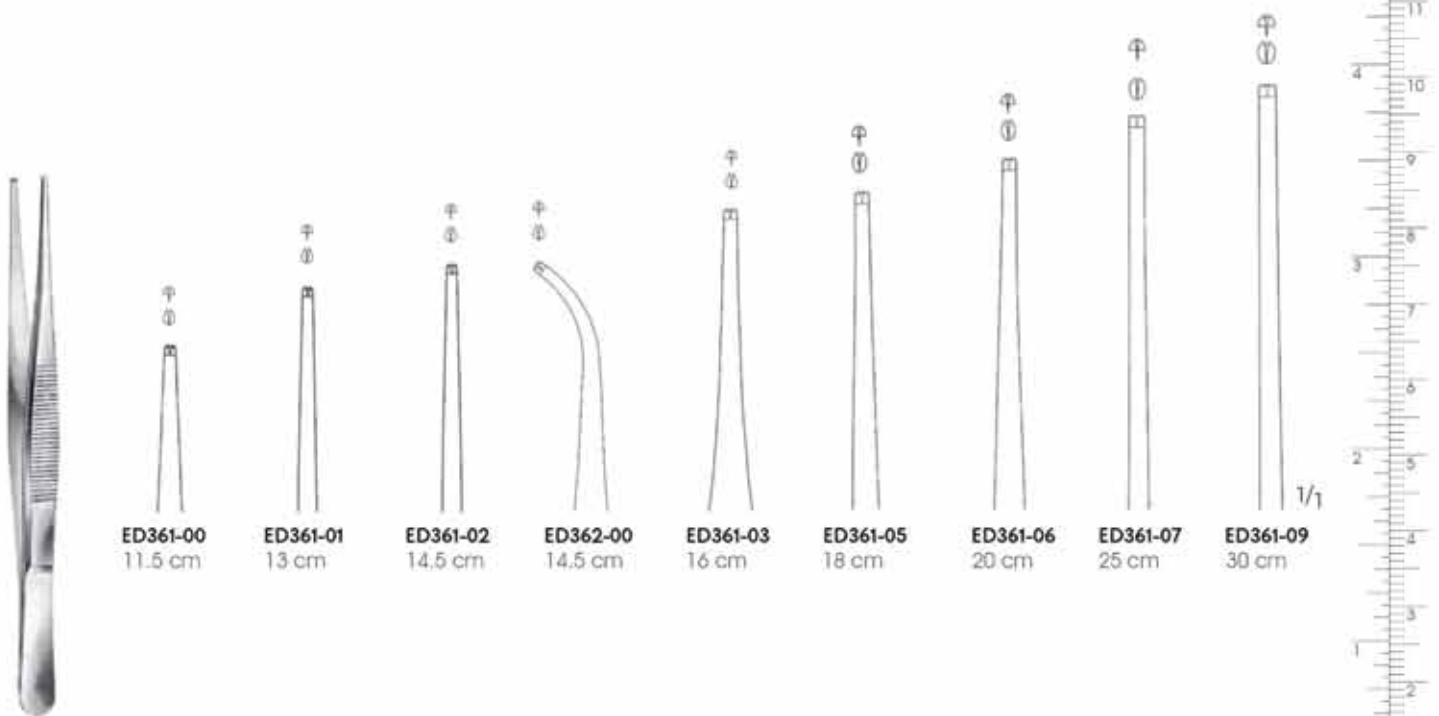

ED361-00-ED362-00
Orta boy/medium



ED384-00
12.5 cm

ED384-01
15 cm

TREVES
ED384-00-ED384-01
Doku pensetleri
Tissue forceps

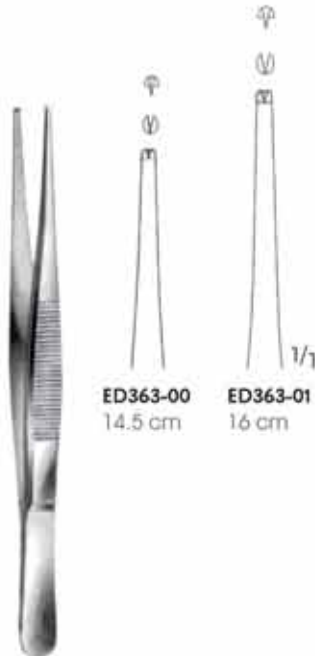

ED363-00
14.5 cm

ED363-01
16 cm

BROPHY
ED363-00-ED363-01
Doku pensetleri
Tissue forceps

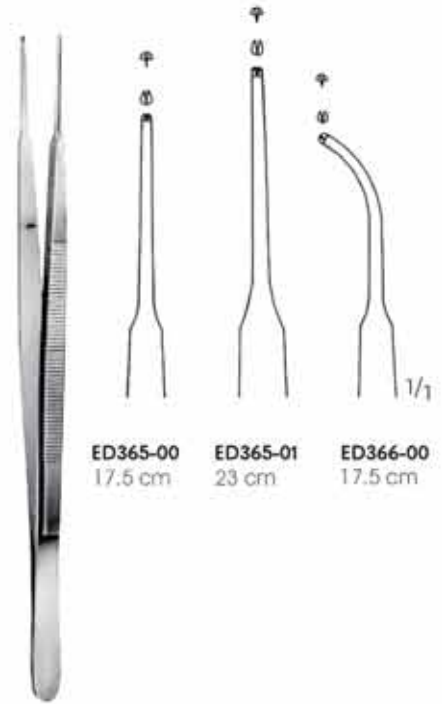

ED365-00
17.5 cm

ED365-01
23 cm

ED366-00
17.5 cm

GERALD
ED365-00-ED366-00
Hassas doku pensetleri
Delicate tissue forceps



ED368-00
Doku penset
Tissue forceps
20 cm



BROPHY
ED339-00
Doku penset
Tissue forceps
20 cm



CUSHING
ED367-00
Doku penset
Tissue forceps
18 cm

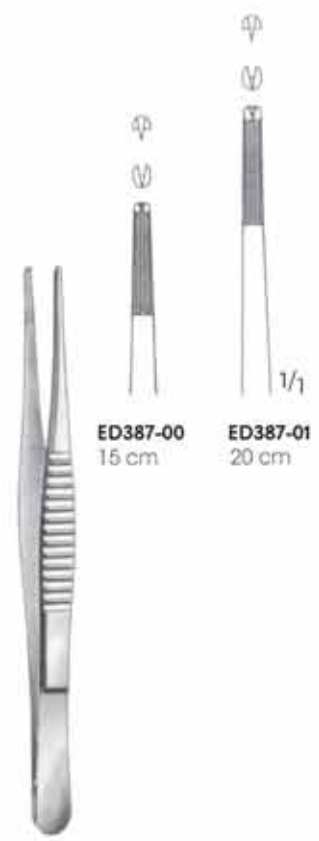

ED387-00
15 cm

ED387-01
20 cm

STRASSBURGER MODEL
ED387-00-ED387-01
Doku pensetleri
Tissue forceps

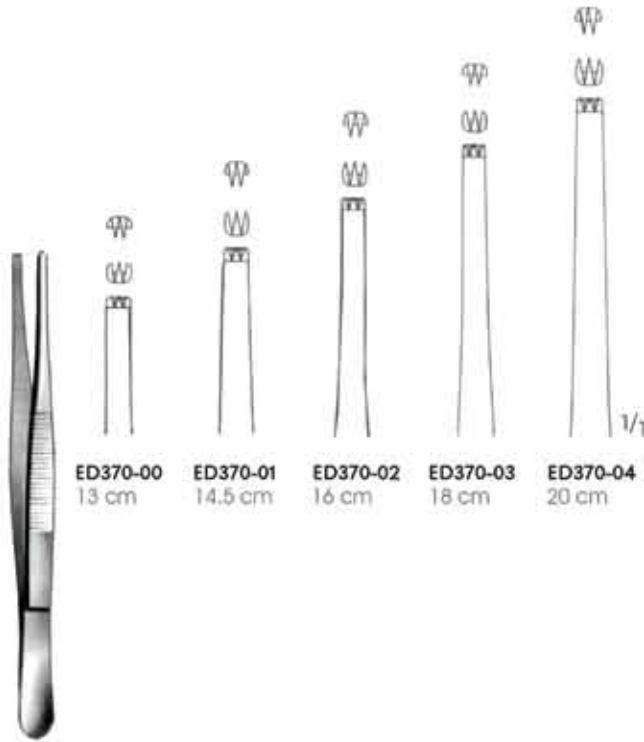

ED370-00 13 cm
ED370-01 14.5 cm
ED370-02 16 cm
ED370-03 18 cm
ED370-04 20 cm

ED370-00-ED370-04
2 x 3 diş/2 x 3 teeth

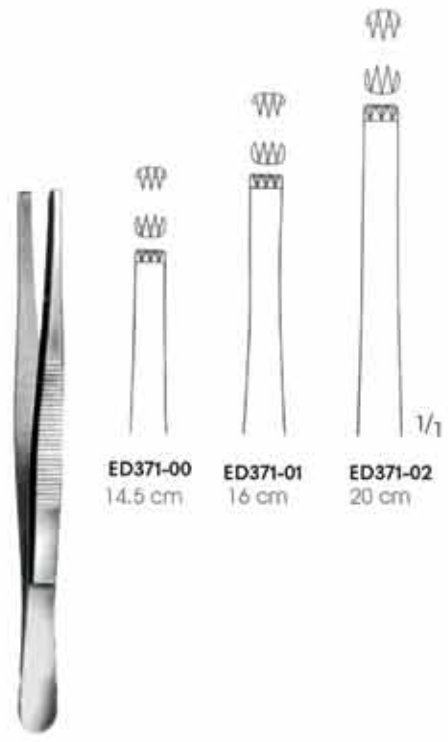

ED371-00 14.5 cm
ED371-01 16 cm
ED371-02 20 cm

ED371-00-ED371-02
3 x 4 diş/3 x 4 teeth



4 x 5 diş
4 x 5 teeth

ED373-00
14.5 cm



ED364-00
Güçlü model/Heavy Pattern
14.5 cm



MC INDOE
ED380-00
15 cm



GILLIES
ED381-00
15.5 cm



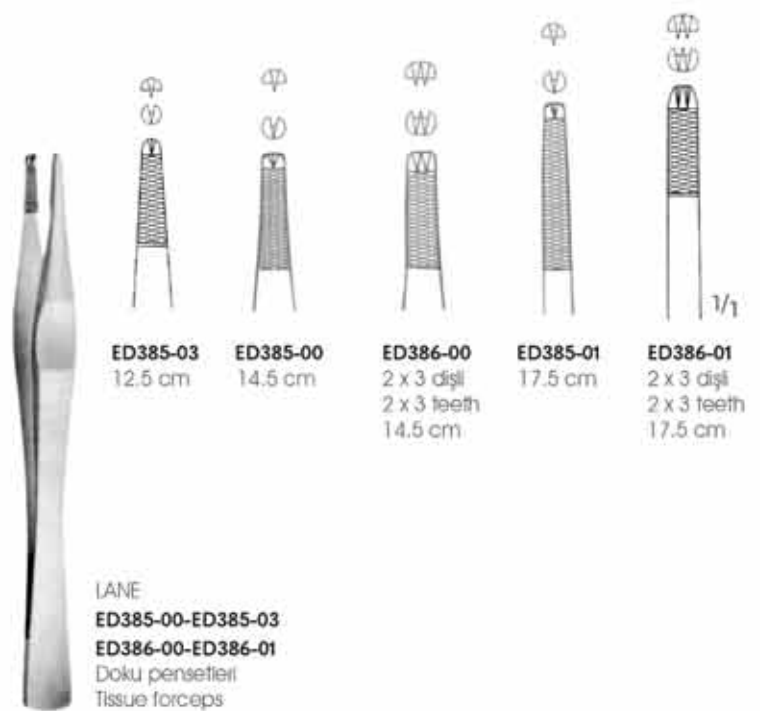
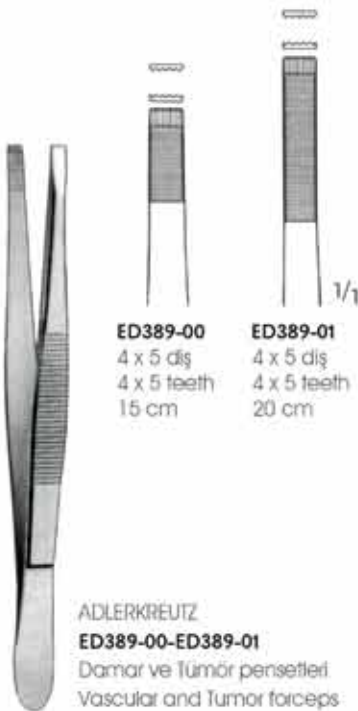
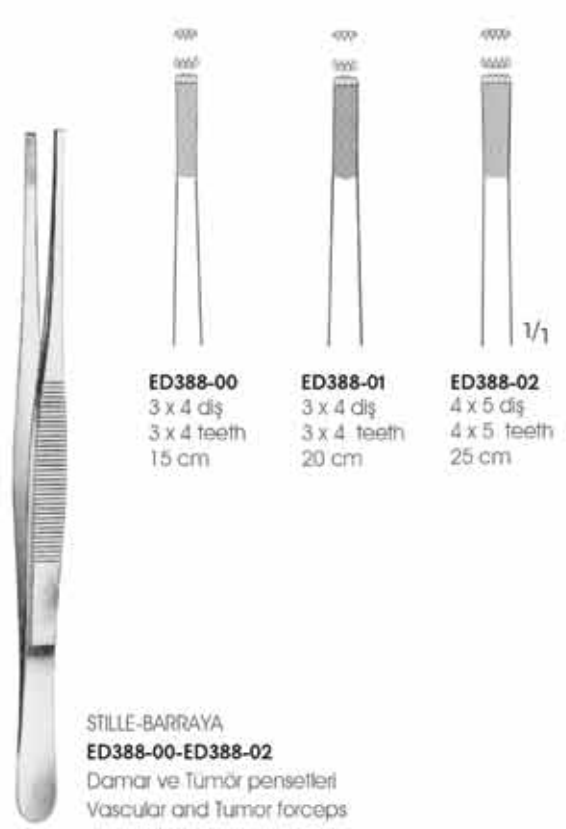
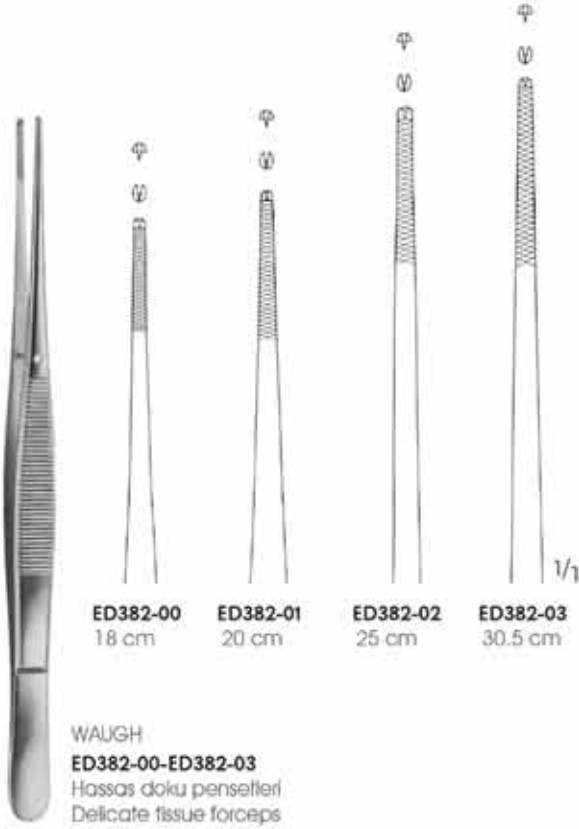

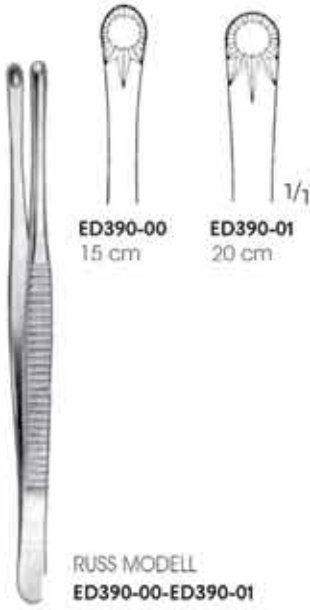

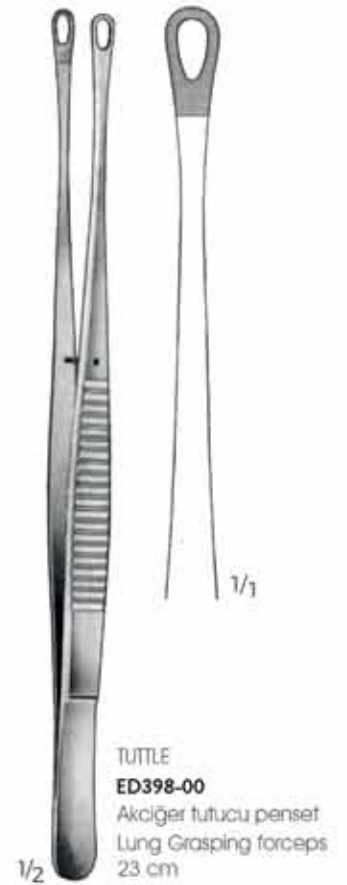
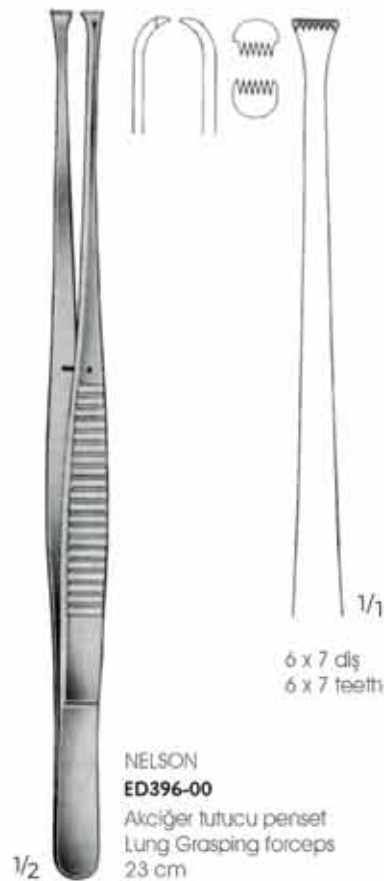
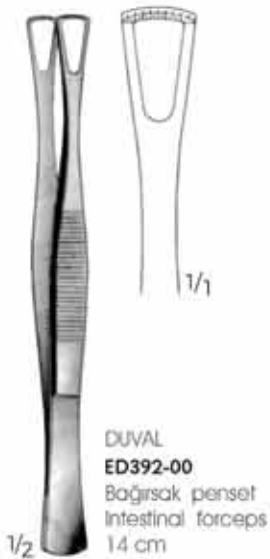
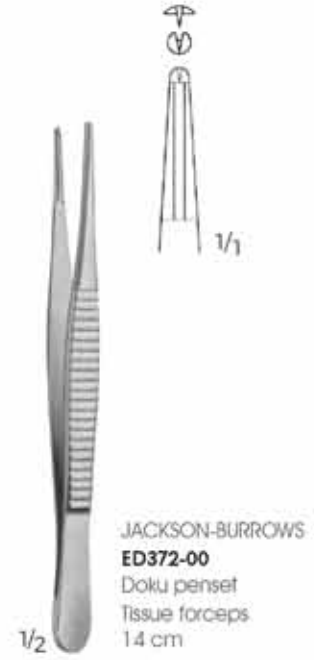
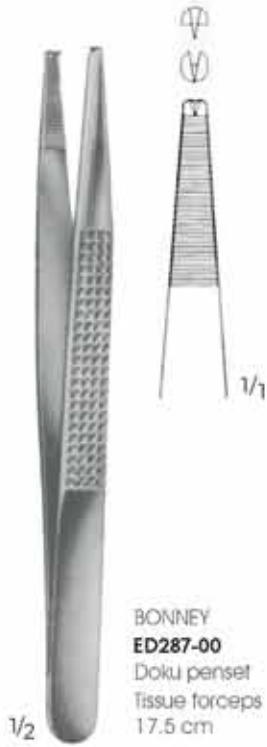



ED410-00
Kıymık penset
Splinter forceps
8 cm

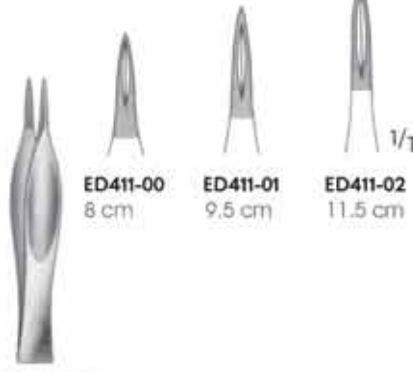

FEILCHENFELD
ED411-00-ED411-02
Kıymık pensetler
Splinter forceps

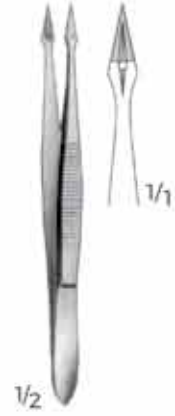

HUNTER
ED412-00
Kıymık penset
Splinter forceps
10.5 cm



STIEGLITZ
ED420-00
Kıymık penset
Splinter forceps
14 cm



STIEGLITZ
ED421-00
Kıymık penset
Splinter forceps
14 cm

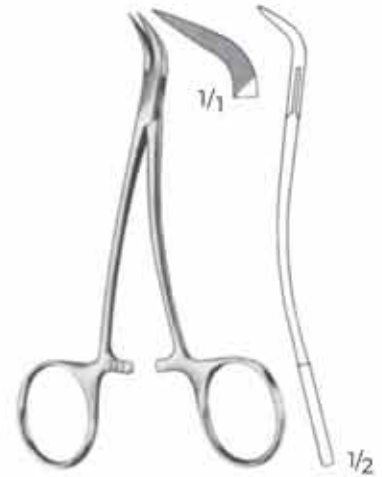

PEET
ED422-00
Kıymık penset
Splinter forceps
12 cm



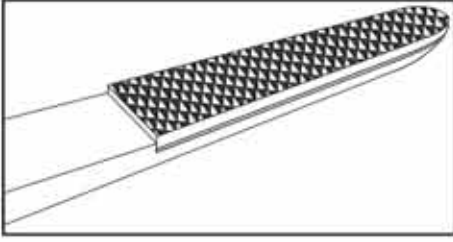

Karbit uclu Diseksiyon Pensetleri

- İnce yapılı karbid ucu sayesinde verimli kullanım...
- Sıkı şekilde ve dokuya zarar vermeden kavrama...
- Çok amaçlı kullanım
- Uzun çalışma süresi

Carbide-tipped dissecting forceps

- Due-to slender carbide tip, efficient use
- Tight gripping without damaging the tissue
- Multi-purpose use
- Long working life

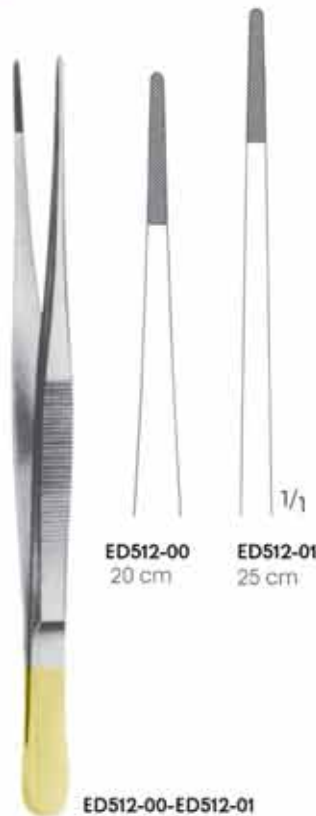
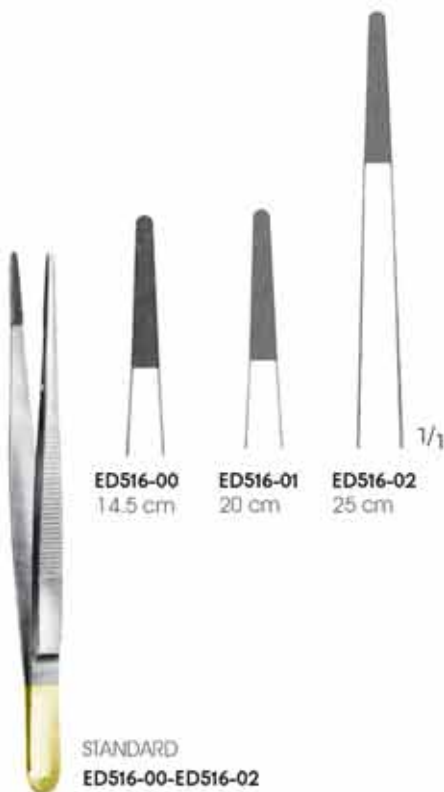

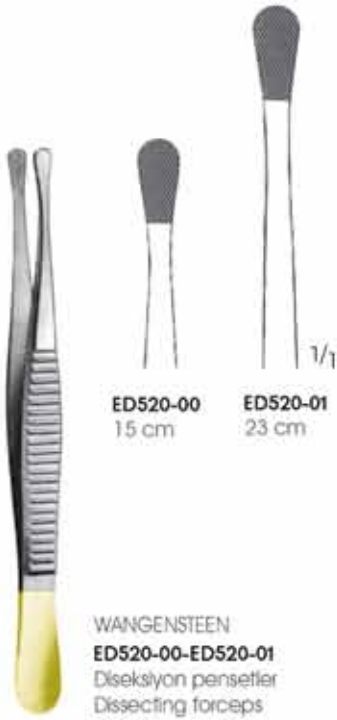

WANGENSTEEN
ED520-00-ED520-01
 Diseksiyon pensetler
 Dissecting forceps



FERRIS-SMITH
ED523-00
 Diseksiyon pensetler
 Dissecting forceps



ED519-00
 Sufür penset/Suture forceps

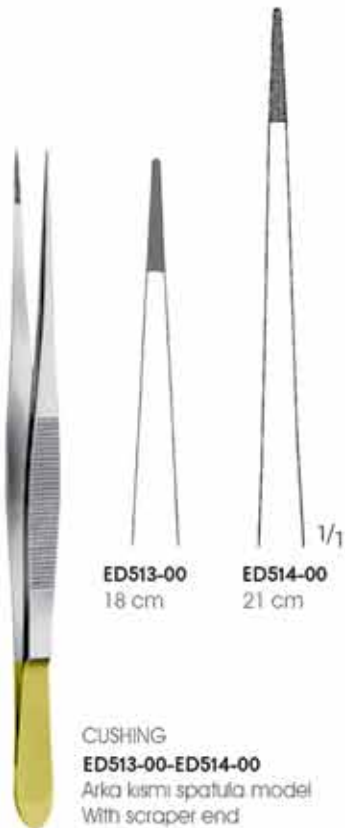

CUSHING
ED513-00-ED514-00
 Arka kısmı spatula model
 With scraper end



ED517-00 14 cm
ED517-01 16 cm
 Diseksiyon pensetler
 Dissecting forceps



GRUENWALD
ED518-00
 Diseksiyon pensetler
 Dissecting forceps

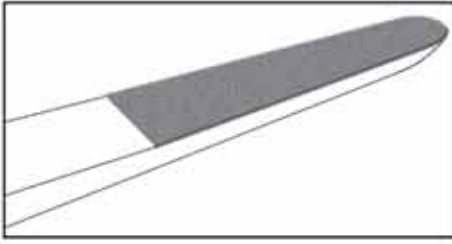

DIA MOTE ağızlar, daha sert ve aşınmaya dayankılı yüzeyler sağlar.
DIA MOTE ağızlar, hassas iğne, suture ve dokuların güvenilir bir şekilde kavranmasını garanti eder.

DIA MOTE jaws provide harder and more wear resistant surfaces.
DIA MOTE jaws ensure reliable grip of fine needles, sutures and tissues.

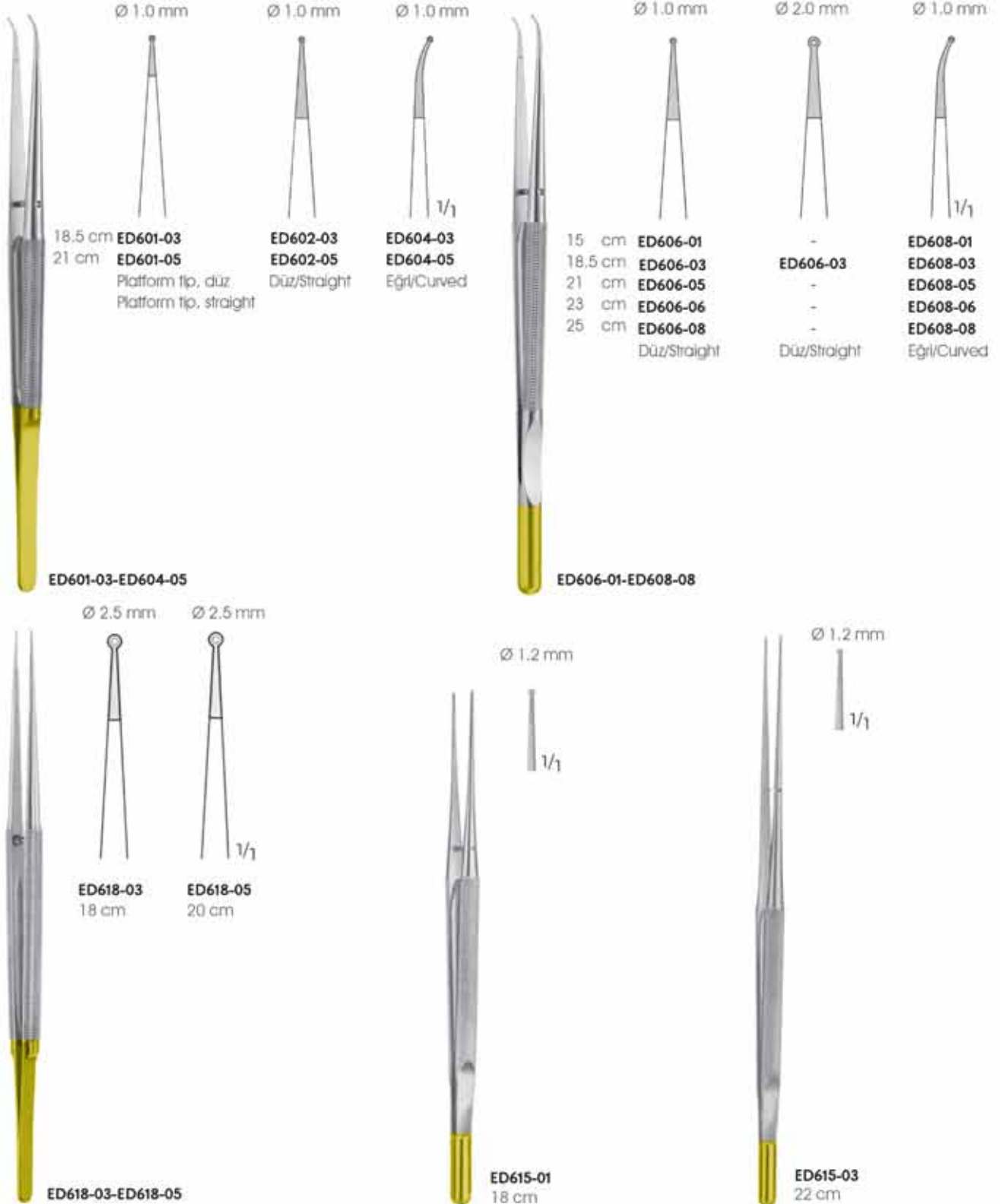



18.5 cm **ED630-02**
21 cm **ED630-04**
Platform tip, düz
Platform tip, straight

ED630-02-ED630-04
Yuvarlak sap/Round handle



15 cm **ED633-01**
18.5 cm **ED633-03**
21 cm **ED633-05**
25 cm **ED633-08**
Platform tip, düz
Platform tip, straight

ED630-01-ED635-08
Yuvarlak sap/Round handle



Platformlu
With plateau

ED637-00
Micro diseksiyon
penset, yuvarlak sap
Micro dissecting forceps,
round handle
18 cm



ED660-03
Ø 1.0 mm
Düz/Straight

ED660-01-ED661-01
Düz sap/Flat handle
18 cm



18 cm **ED665-03**
20 cm **ED665-05**
1.0 mm
Düz/Straight

ED665-03-ED665-05
Düz sap/Flat handle



ED673-00
1 mm
1 x 2 diş
1 x 2 teeth

ED673-00-ED673-10
Dişli doku pensetleri,
düz sap
Mikro tissue forceps
flat handle
18 cm



ED675-00
Düz
1 x 2 diş
Straight
1 x 2 teeth

ED675-00-ED675-10
Mikro dişli doku pensetleri
yuvarlak sap
Mikro tissue forceps
round handle
18 cm

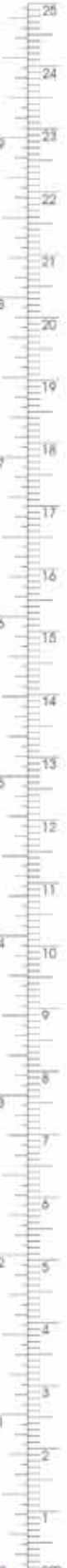

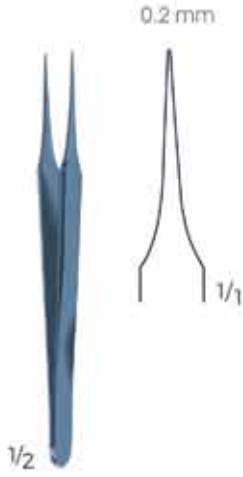

ED103-00T

Mikro penset, kuyumcu tipi
Micro forceps, jeweler patterns
11 cm

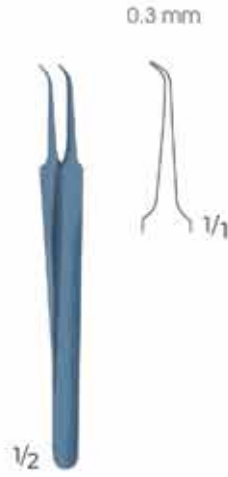

ED104-00T

Mikro penset, kuyumcu tipi
Micro forceps, jeweler patterns
11 cm

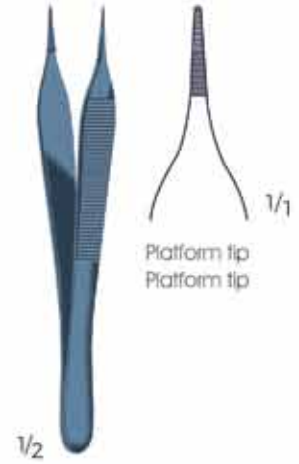

MICRO-ADSON

ED204-00T
Hassas diseksiyon penset
Delicate dissecting forceps
12 cm



ED609-01T 18,5 cm
ED609-03T 21 cm
ED609-05T 23 cm
Platformlu tip, düz
Platform tip, straight



ED610-01T 18,5 cm
ED610-03T 21 cm
ED610-05T 23 cm
Düz, straight

De Bakay Diş



Toothing De Bakay

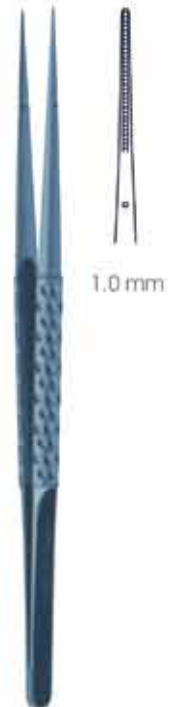

ED257-01T 18,5 cm
ED257-03T 21 cm
ED257-05T 23 cm
Düz, straight



1/2

MICRO - ADSON

ED322-00T

Hassas dişli doku penset
Delicate tissue forceps
12 cm



1/1



1/2

ADSON

ED323-00T

Hassas dişli doku penset
Delicate tissue forceps
12 cm



1/1



1/2

ADSON

ED324-00T

Hassas dişli doku penset
Delicate tissue forceps
12 cm



Platformu
With plateau



ED360-02T
13 cm



ED360-03T
14.5 cm



ED360-04T
16 cm



ED360-05T
18 cm



ED360-06T
20 cm

ED360-02T-ED360-06T

Dişli doku penseller, standart model
Tissue forceps, standard patterns



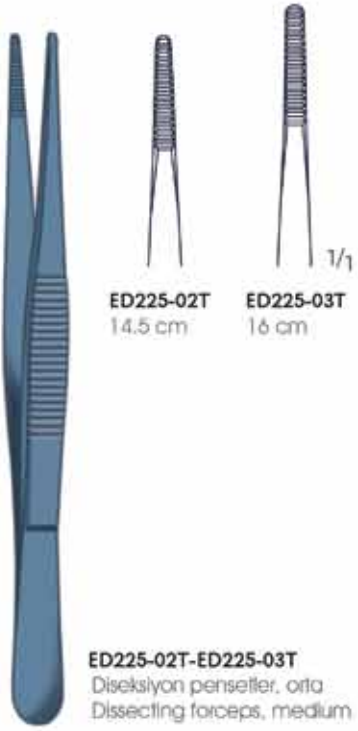

ED225-02T-ED225-03T
Diseksiyon pensetler, orta
Dissecting forceps, medium

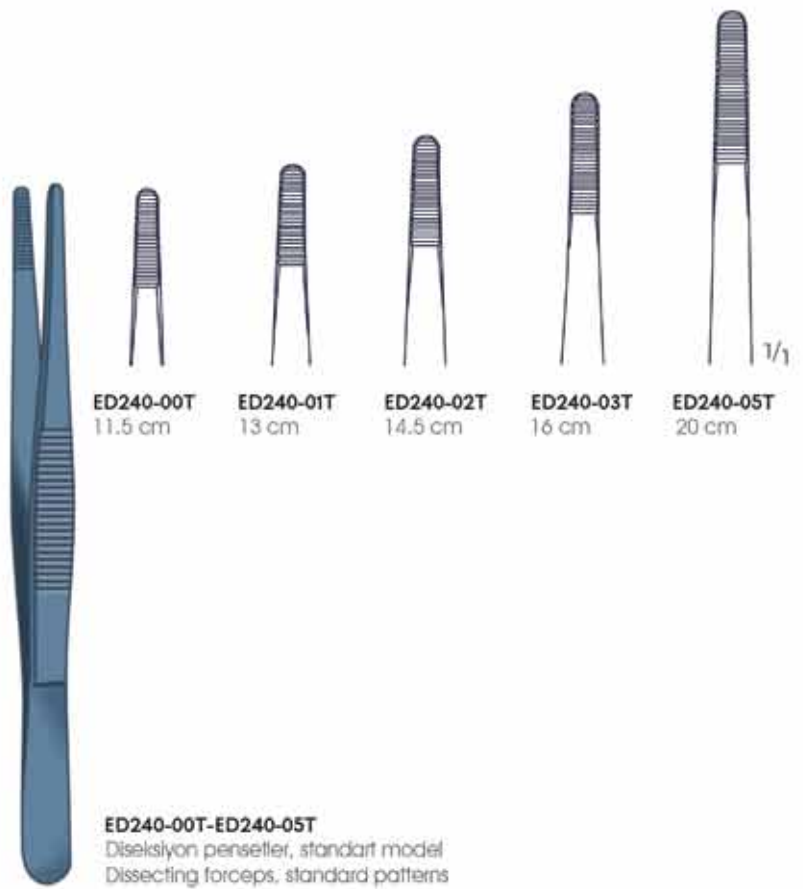

ED240-00T-ED240-05T
Diseksiyon pensetler, standart model
Dissecting forceps, standard patterns



CUSHING
ED220-00T-ED220-01T
Hassas diseksiyon pensetler
Delicate dissecting forceps

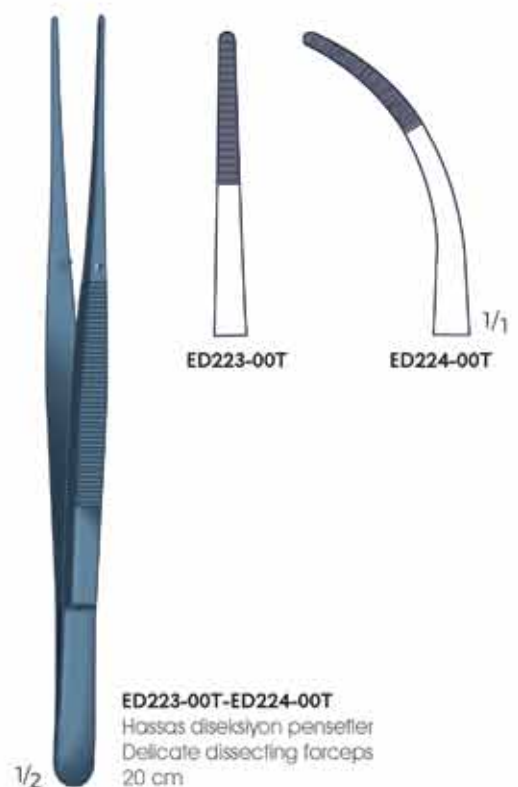

ED223-00T-ED224-00T
Hassas diseksiyon pensetler
Delicate dissecting forceps
20 cm

De Bakey Diş



Toothing De Bakey

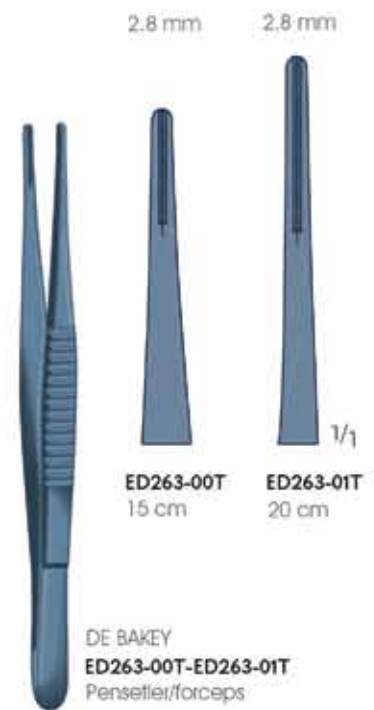
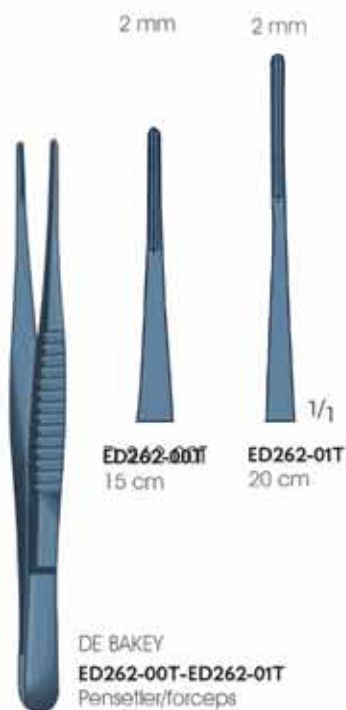
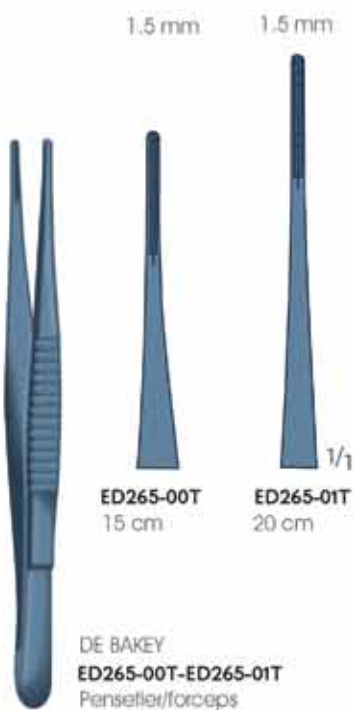
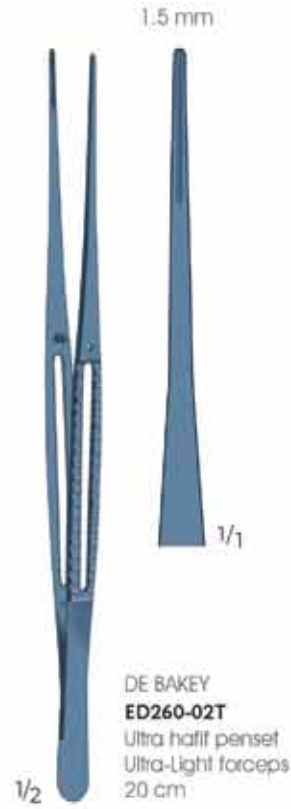
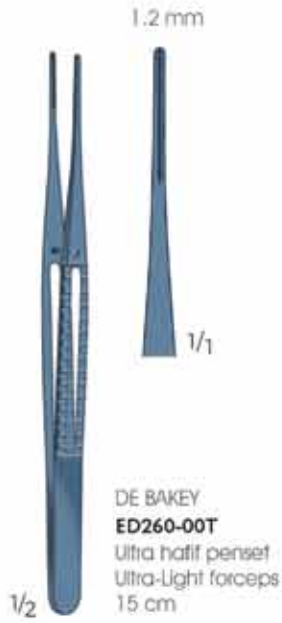

EE

Spanç, Doku ve Çamaşır Pensleri
Sponge, Tissue and Washing Forceps



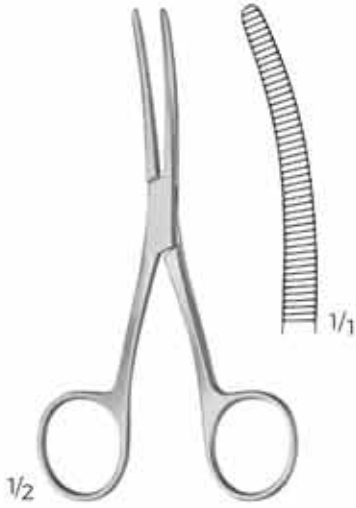

BRYANT
EE004-00
13 cm

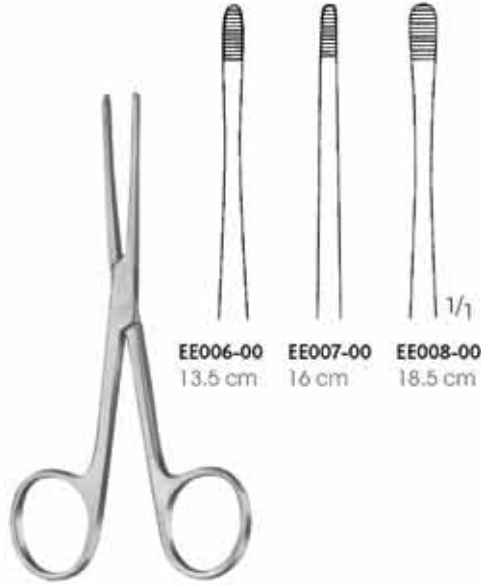

LISTER
EE006-00-EE008-00
Burun pensleri/Sinus forceps

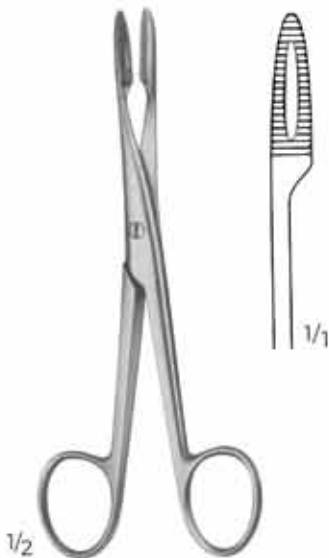
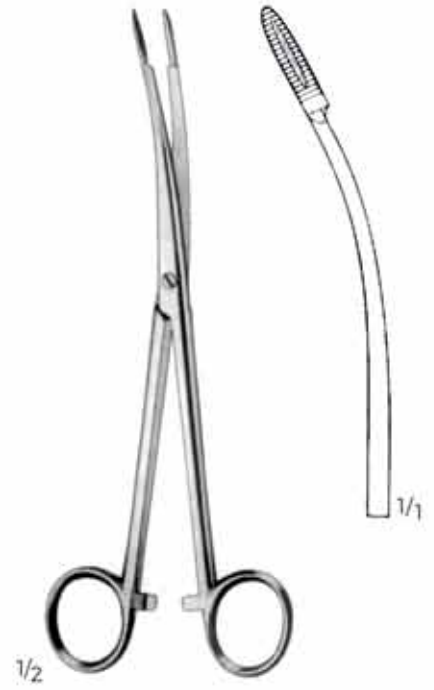

EE010-00
Kilitli/ Without ratchet
14.5 cm

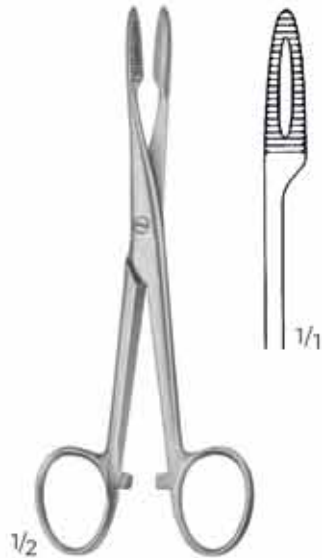

EE011-00
Kilitli/ With ratchet
14.5 cm

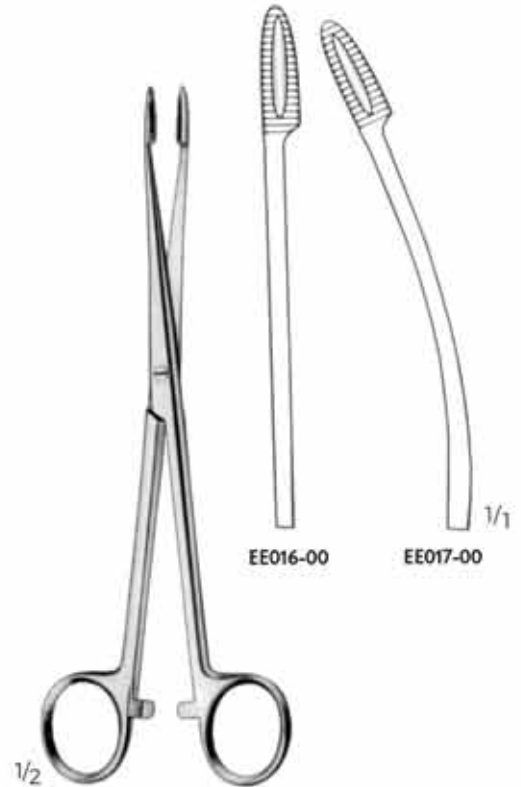

GROSS
EE016-00-EE017-00
Kilitli/ With ratchet
18 cm

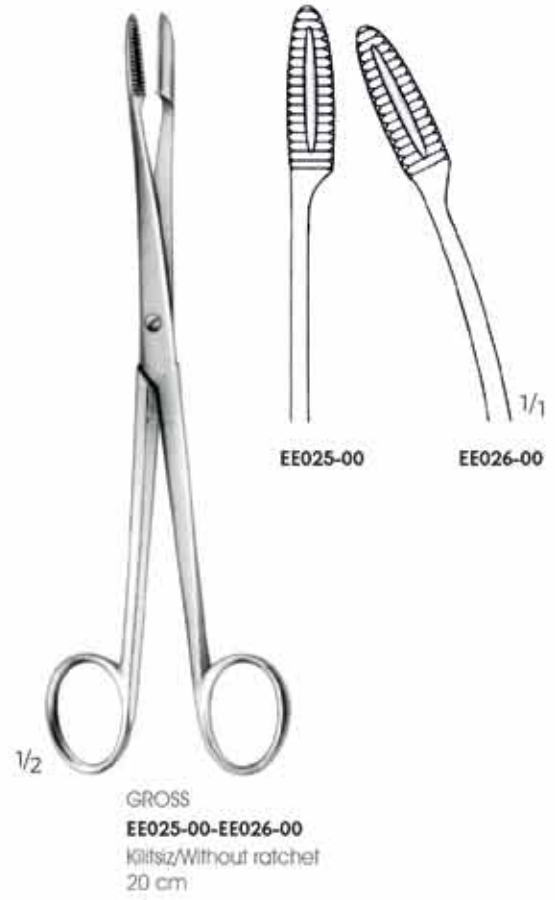
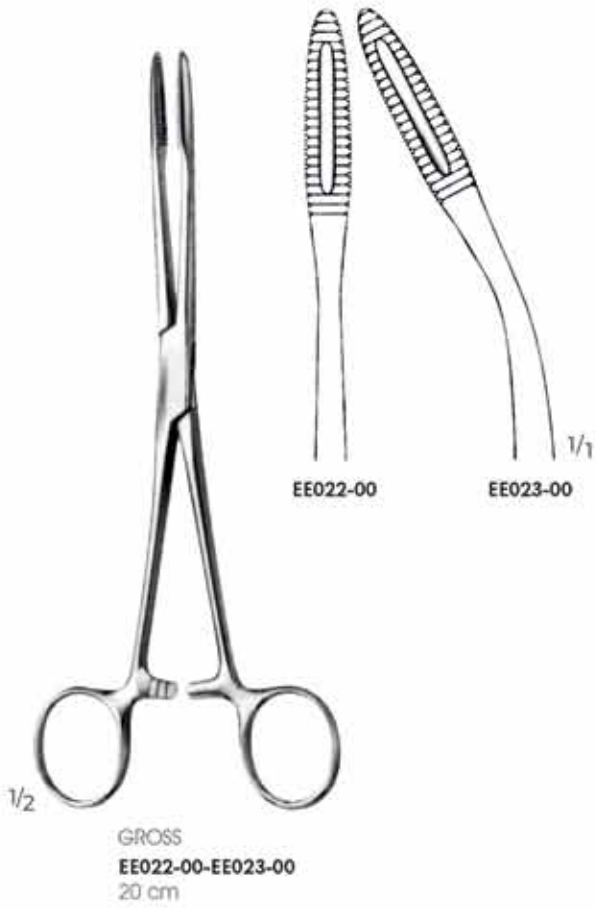

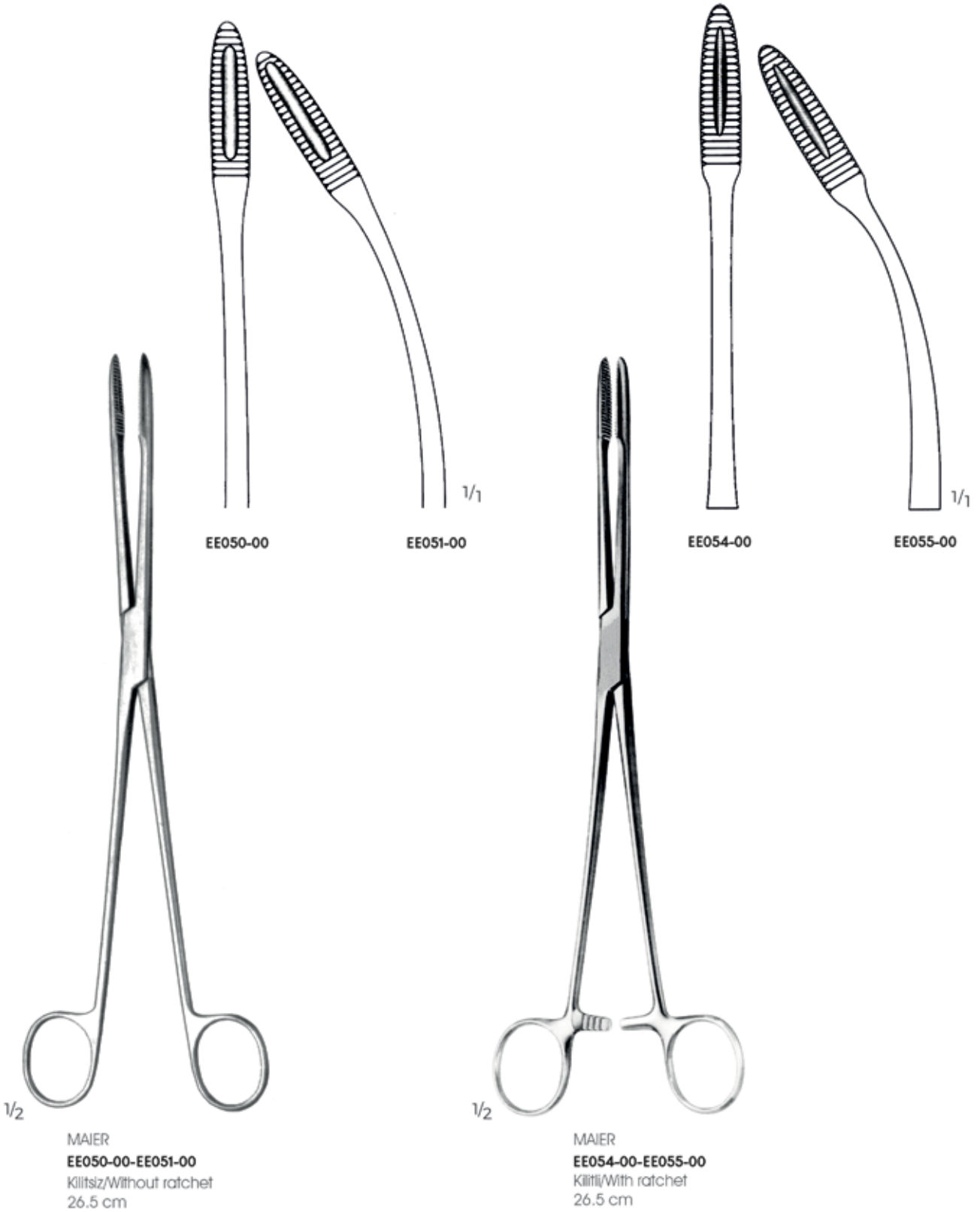



EE056-00

EE057-00

EE056-00-EE057-00
24 cm

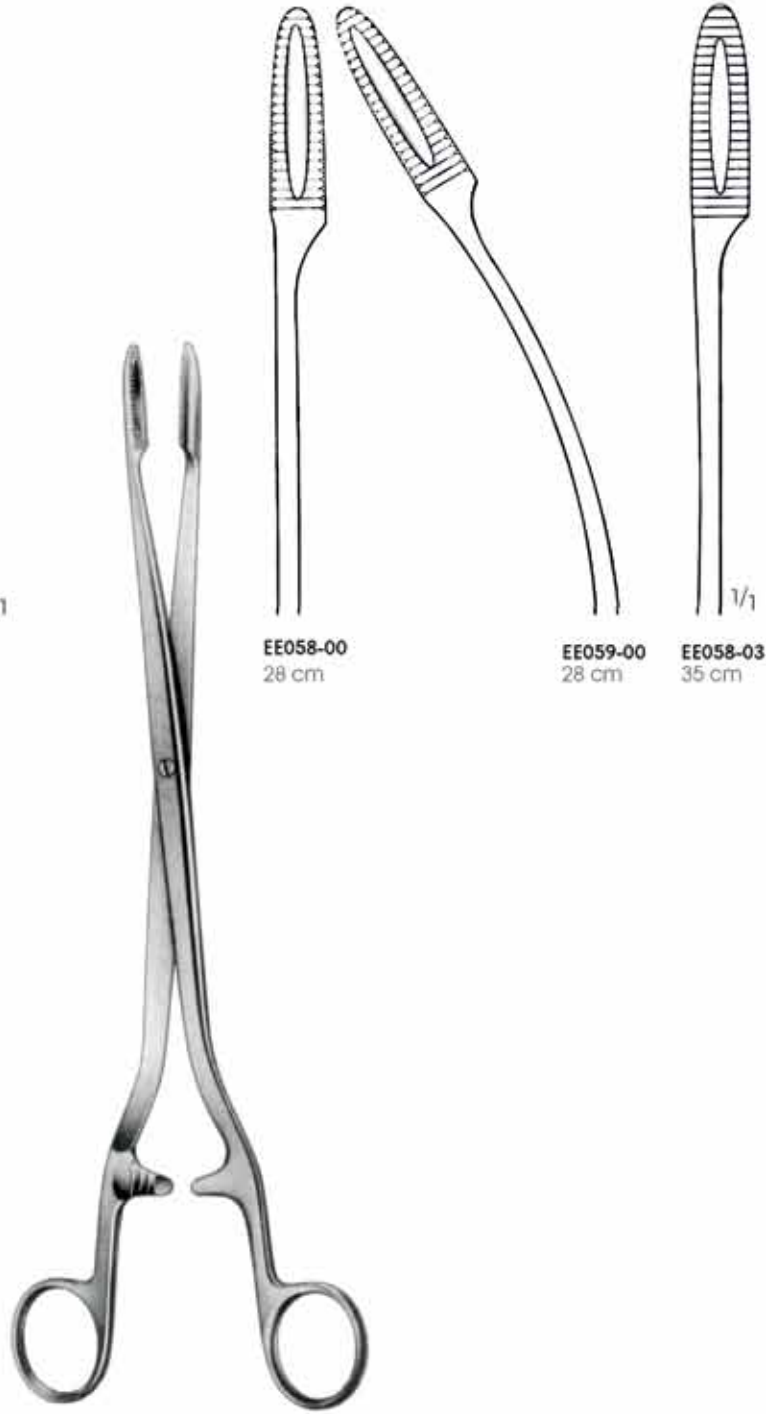

EE058-00
28 cm

EE059-00
28 cm

EE058-03
35 cm

SIMS-MAIER
EE058-00-EE058-03-EE059-00



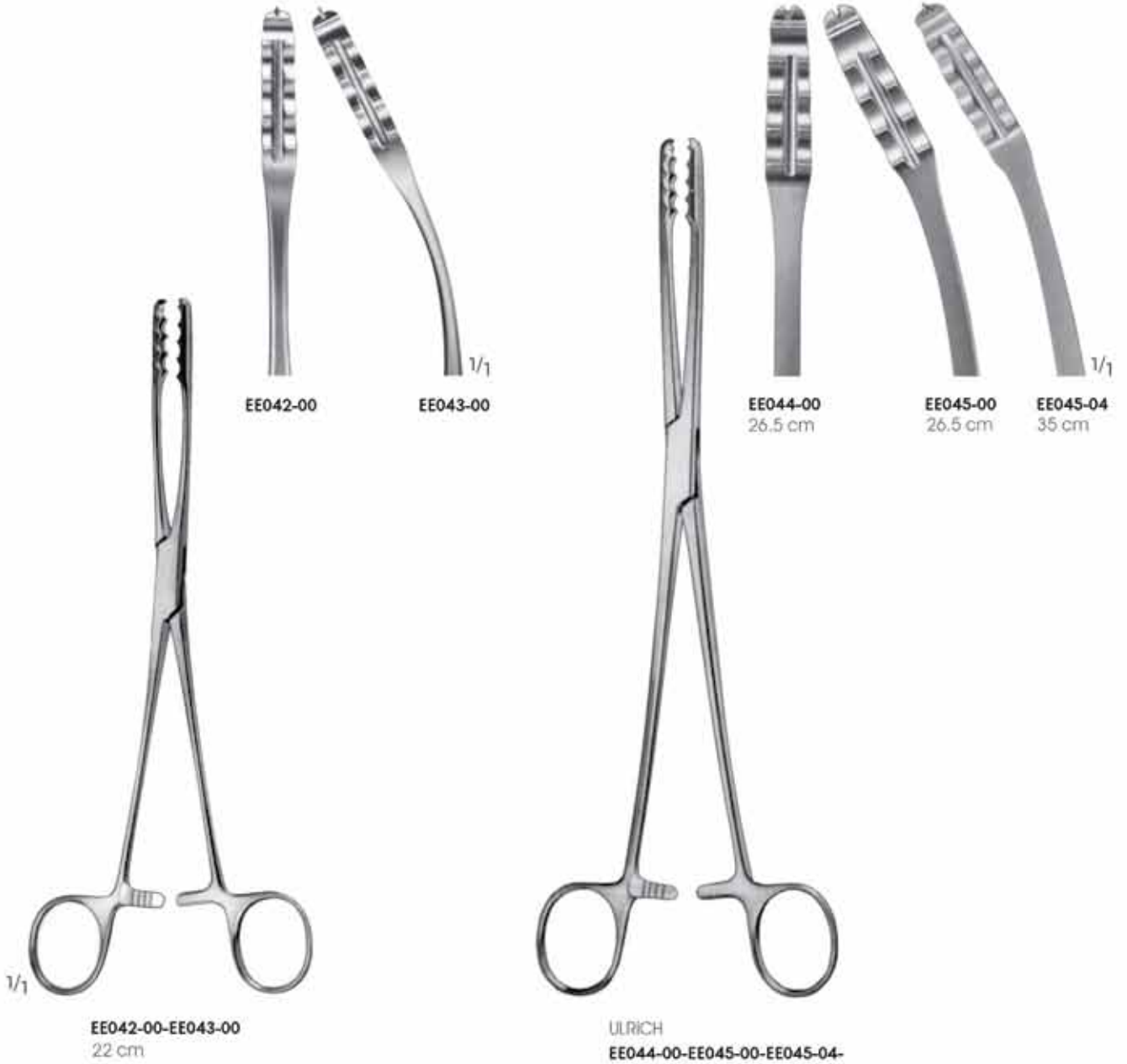



EMMET
EE070-00
21 cm



COLLIN
EE071-00
24 cm

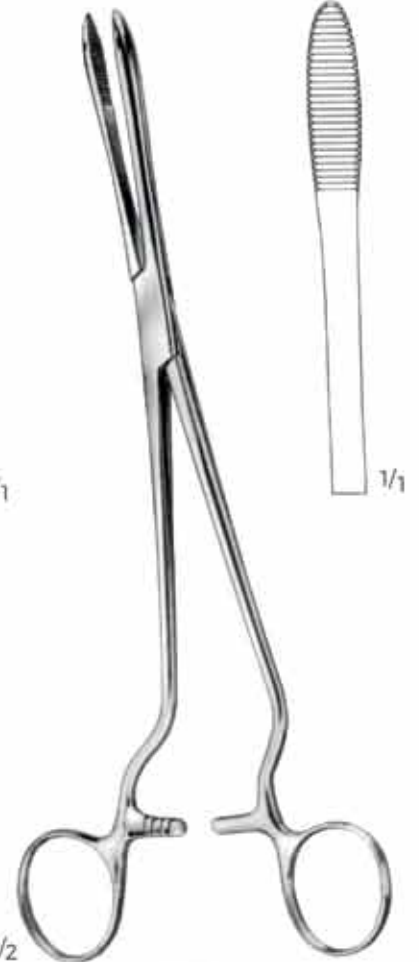

CHERON
EE072-00
Açılı saplar
Handles angled to side
24 cm



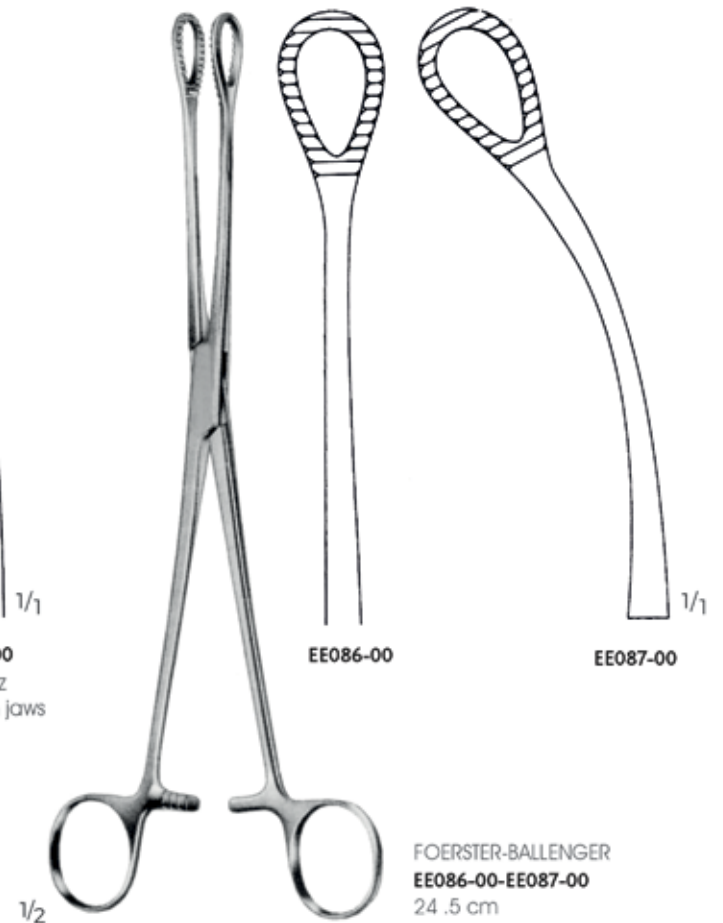
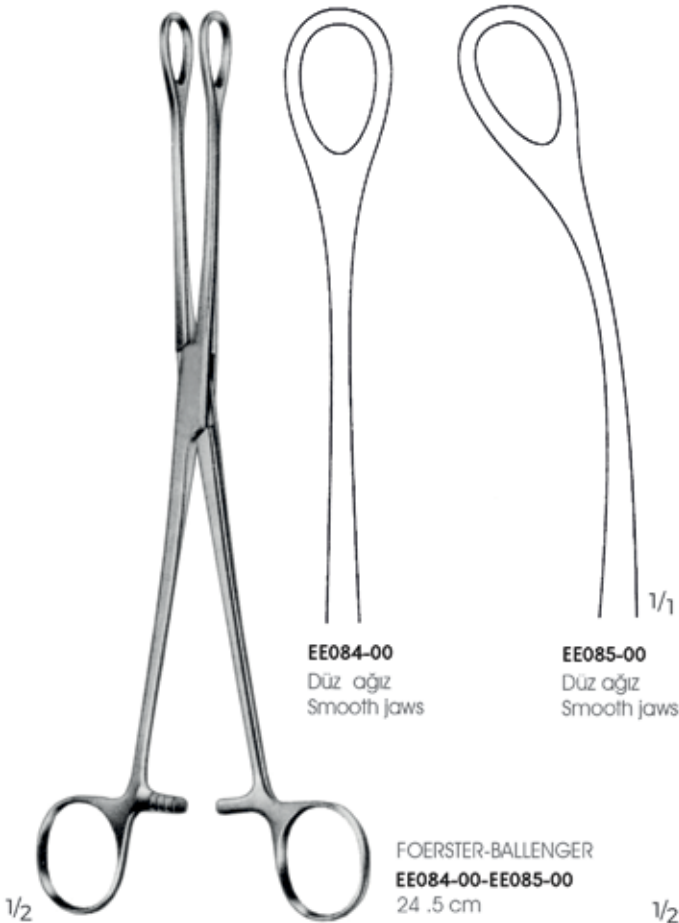
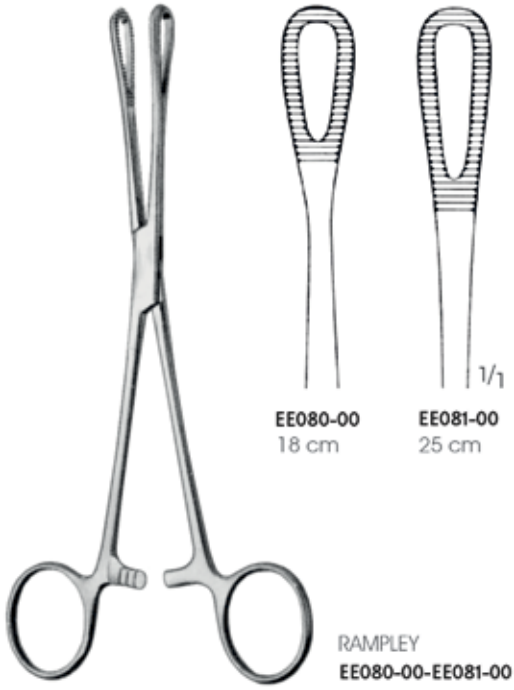

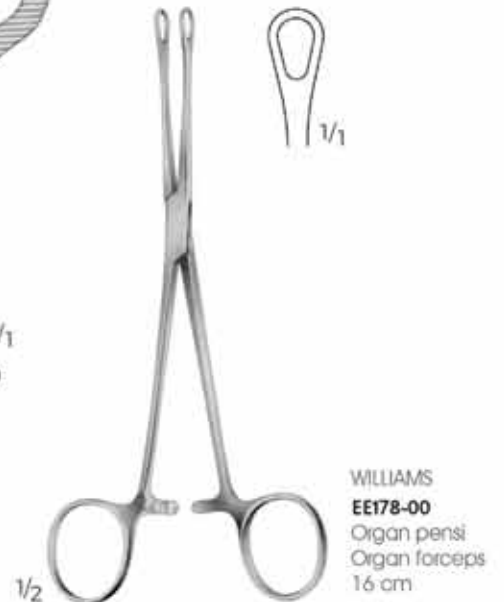
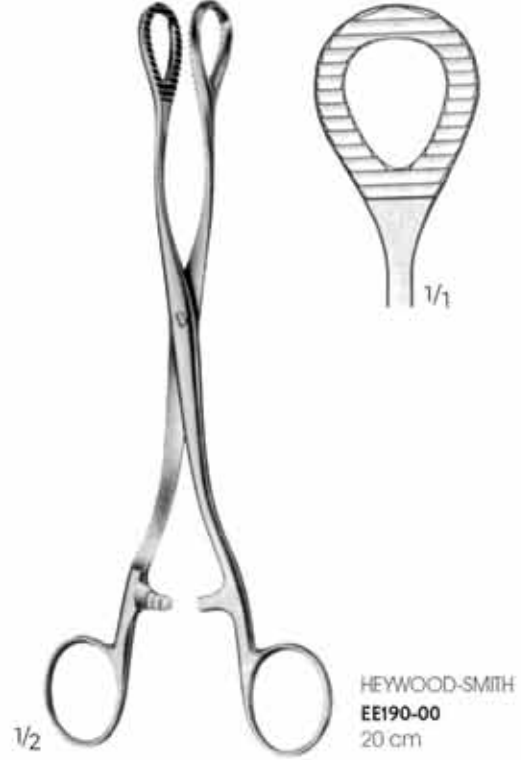
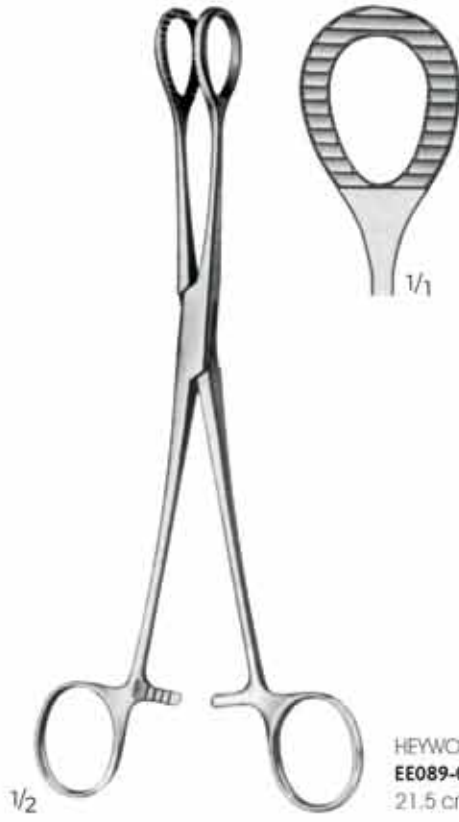

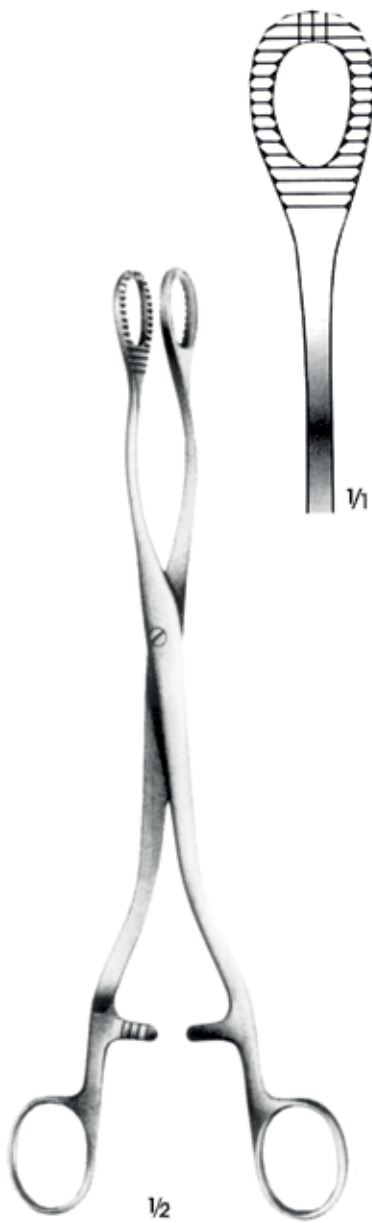

HEYWOOD-SMITH
EE198-00
25 cm

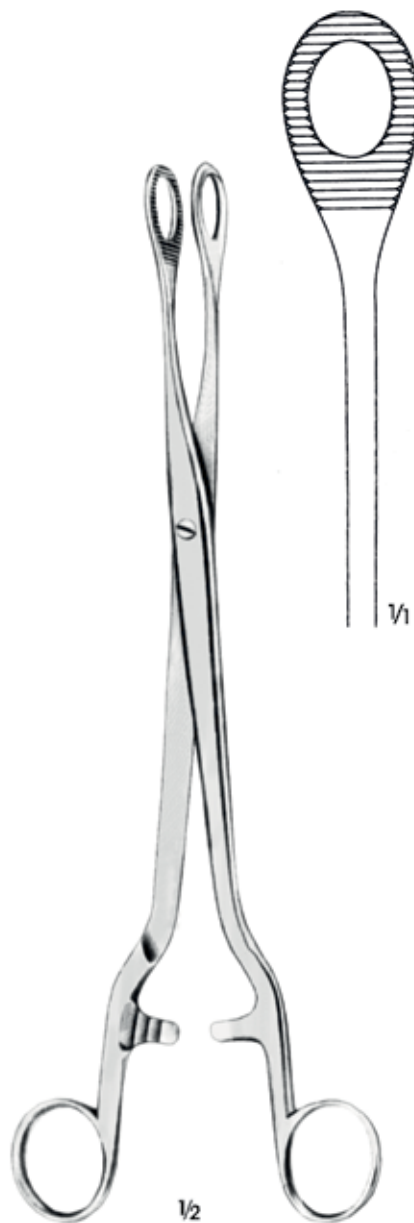

NOTO
EE120-00
28 cm

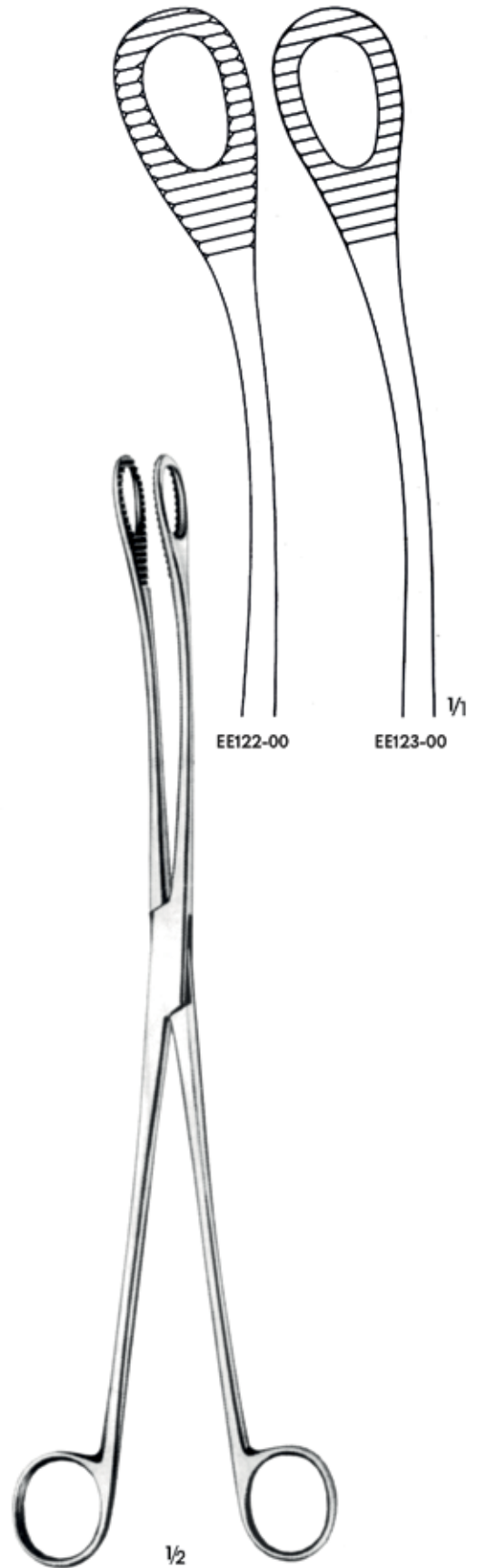

KELLY
EE122-00-EE123-00
32 cm

De Bakey Diş



Toothing De Bakey



2/3 sıra diş
2/3 teeth rows

21 mm 23 mm

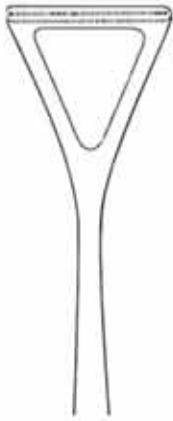

EE187-00



EE187-01

21 mm

27 mm



EE130-00

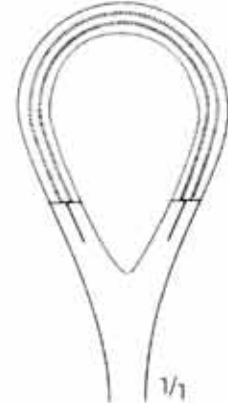

EE130-01



COLLIN

EE187-00 19.5 cm

EE187-01 23 cm



EE130-00 25 cm

EE130-01 27 cm



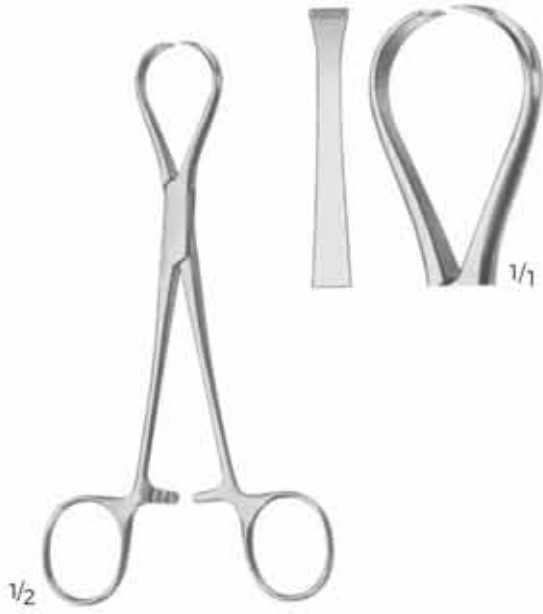

JACKSON
EE300-00
Tendon tutucu pens
Tendon seizing forceps
4x5 diş/4x5 teeth
16 cm

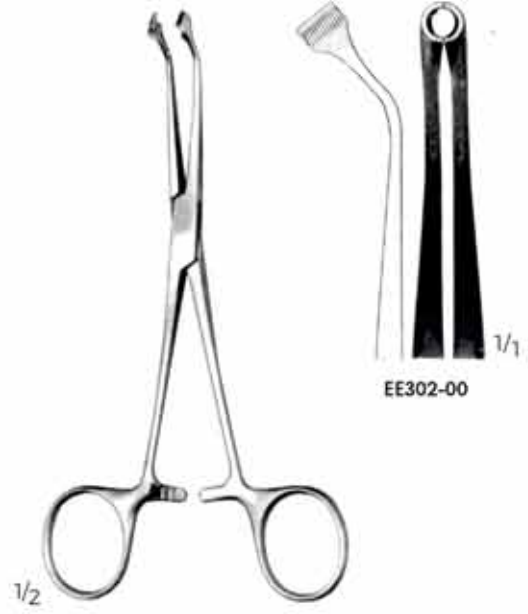

HERZ
EE302-00-EE302-01
Tendon tutucu pens
Tendon seizing forceps
15.5 cm



EE310-00
Tendon geçmeli pens
Tendon seizing forceps
12 cm



EE311-00-EE312-00
Tendon geçmeli pensler
Tendon interlacing forceps
15 cm

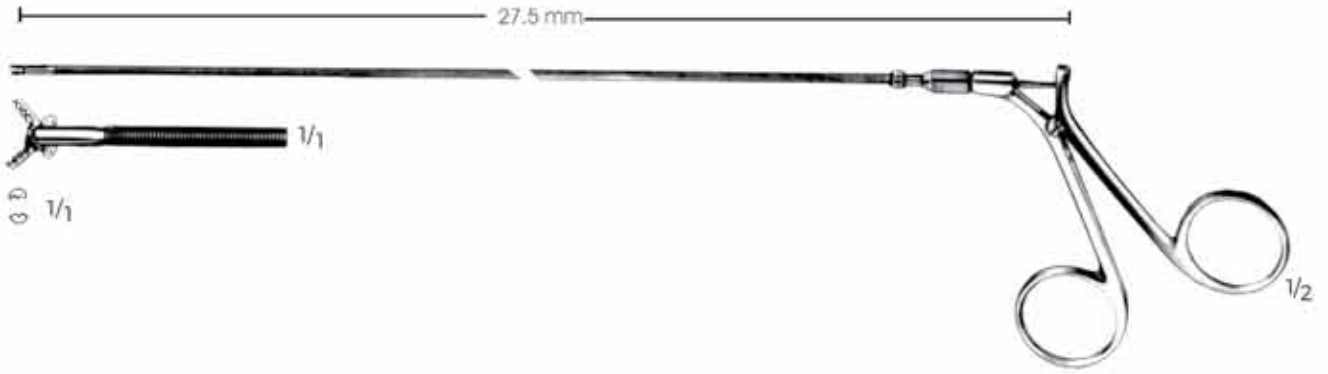

JAGER

EE330-00

Tendon ve çapraz bağlara geçiş
sağlayan pens, esnek şaft
Tendon and cross ligament passing
forceps flexible shaft
27.5 cm



EE331-00
Düz/Straight
18.5 cm

EE331-01
Eğil/Curved
18.5 cm

EE332-00
Düz/Straight
15 cm

EE332-01
Eğil/Curved
15 cm

BRAND

EE331-00-EE332-01

Tendon tutma pensleri
Tendon holding forceps



KLEINERT-KUTZ

EE338-00

Tendon geçiş pensli
Tendon passing forceps
20.5 cm



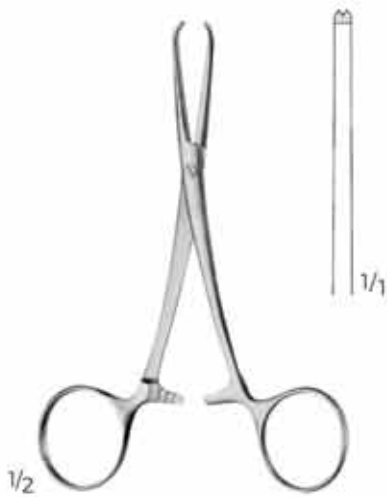

POIRIER
EE148-00
2 x 3 diş
2 x 3 teeth
12.5 cm



CHAPUT
EE140-00
2 x 3 diş, sivri
2 x 3 teeth, sharp
12.5 cm



TUFFIER
EE141-00
5 x 6 diş, sivri
5 x 6 teeth, sharp
12.5 cm

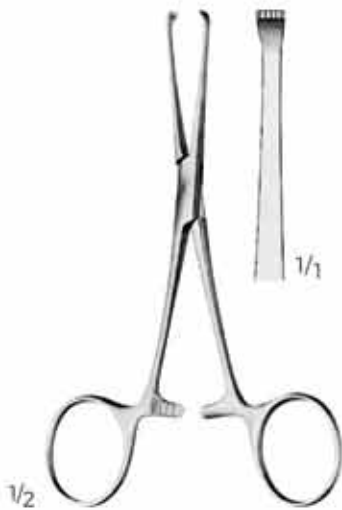

BABY-ALLIS
EE142-00
4 x 5 diş/4 x 5 teeth
13 cm



BOYS-ALLIS
EE143-00
5 x 6 diş/5 x 6 teeth
15.5 cm

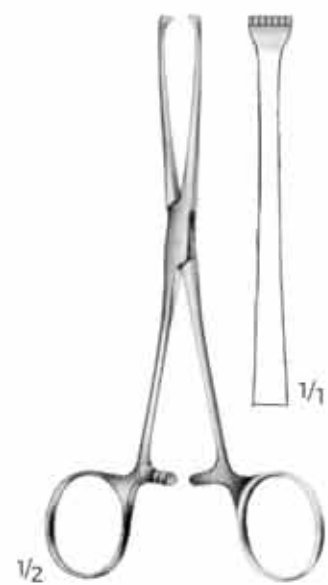

ALLIS
EE144-00
5 x 6 diş/5 x 6 teeth
15.5 cm

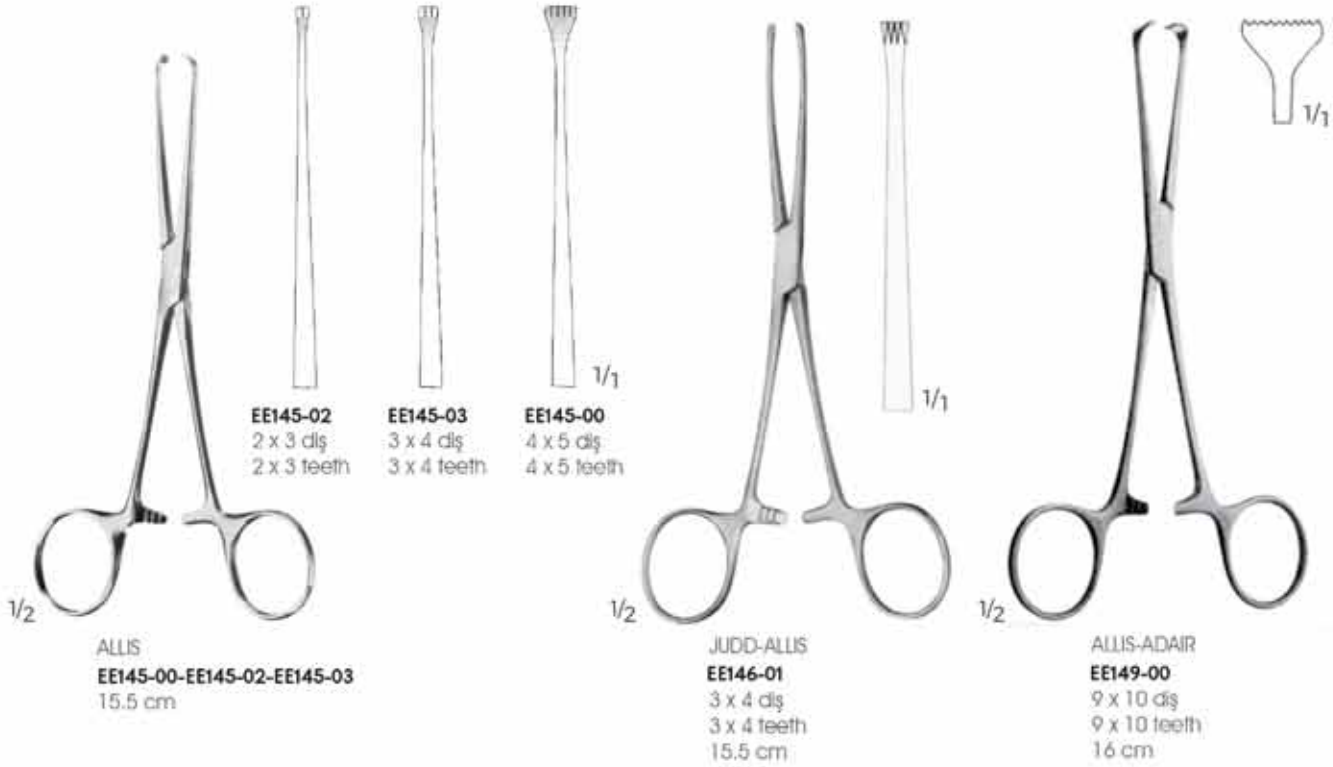

Atromatik
Atraumatic



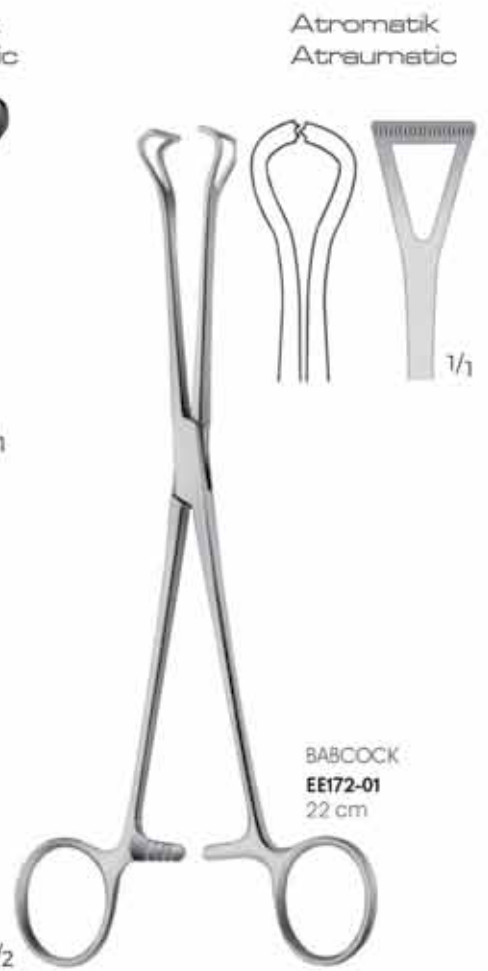
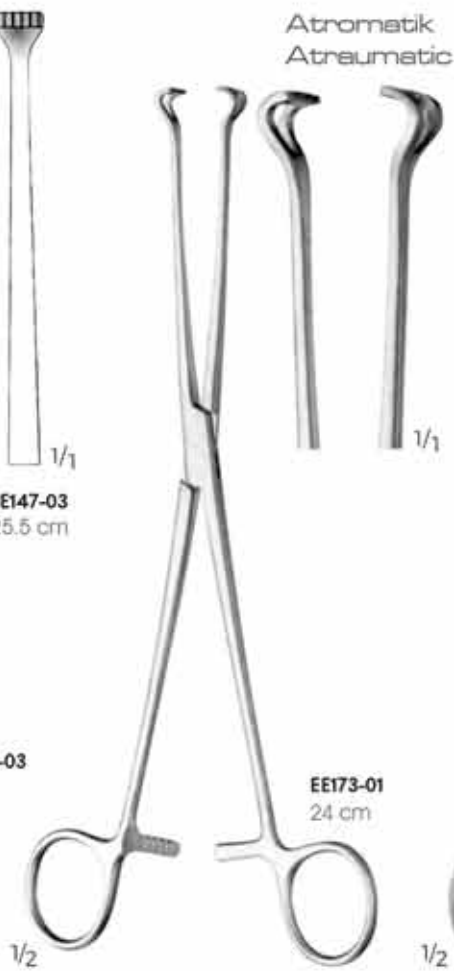
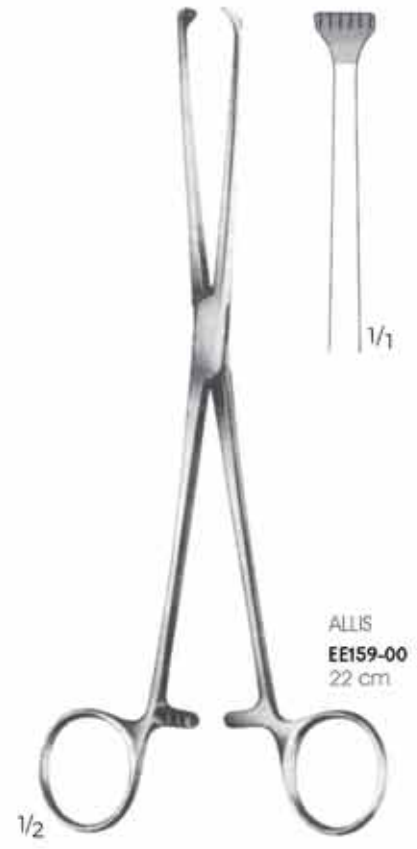
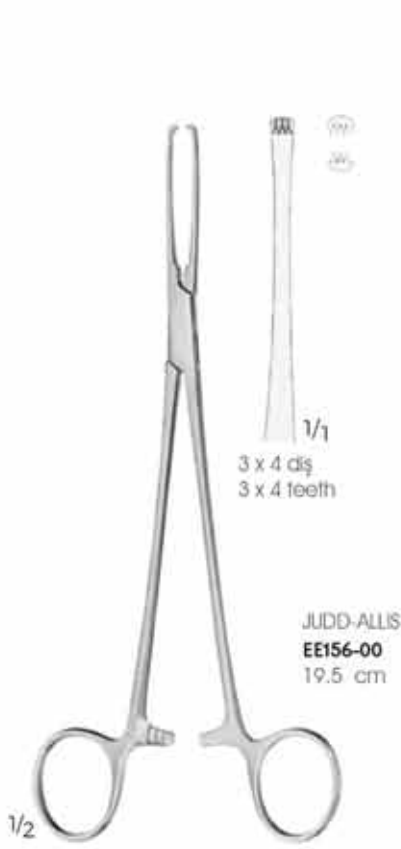

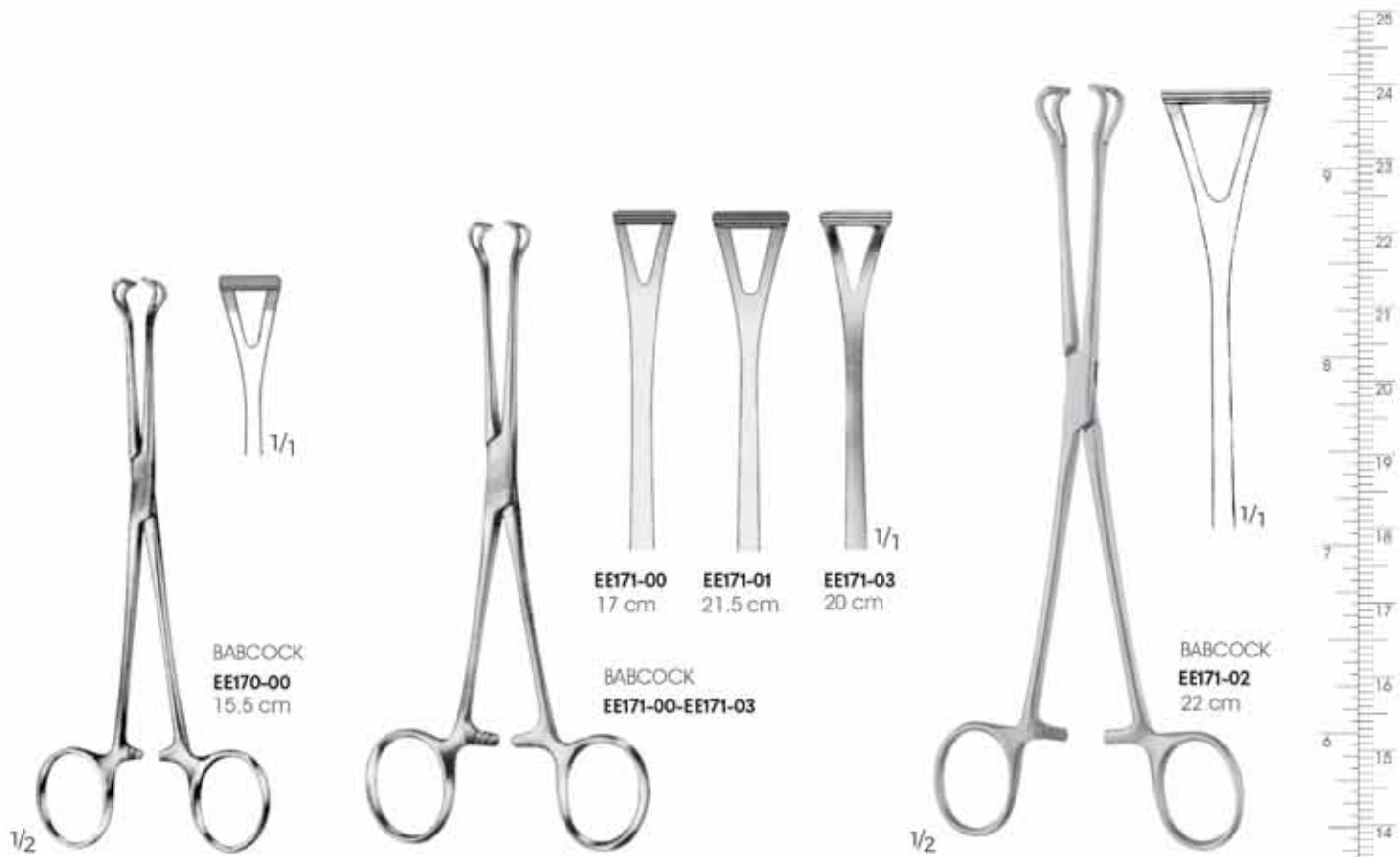

Atromatik
Atraumatic



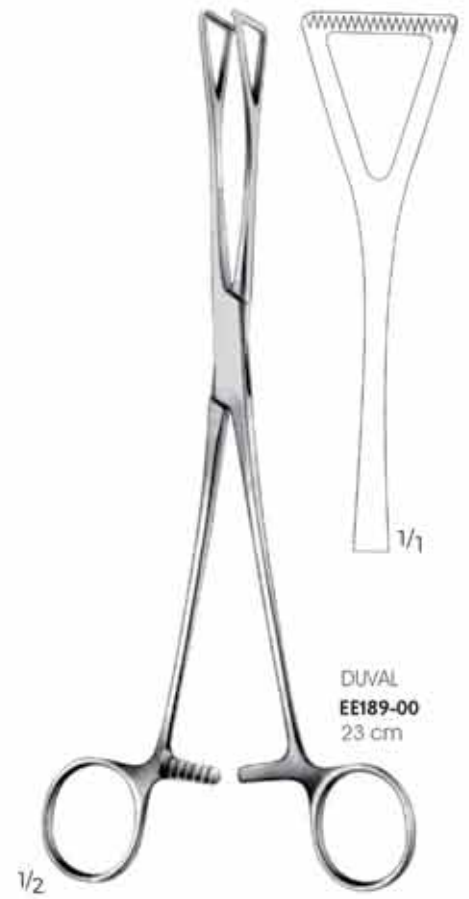

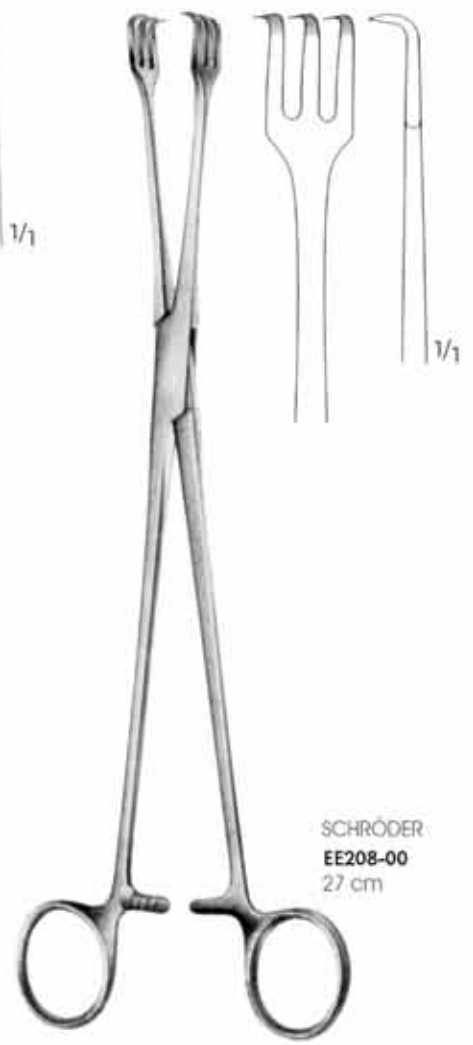
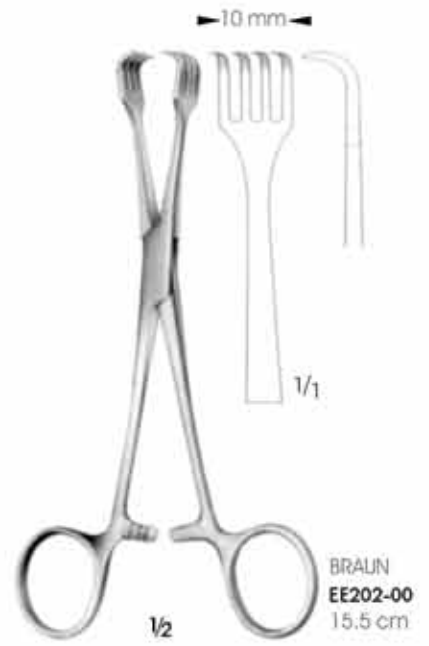
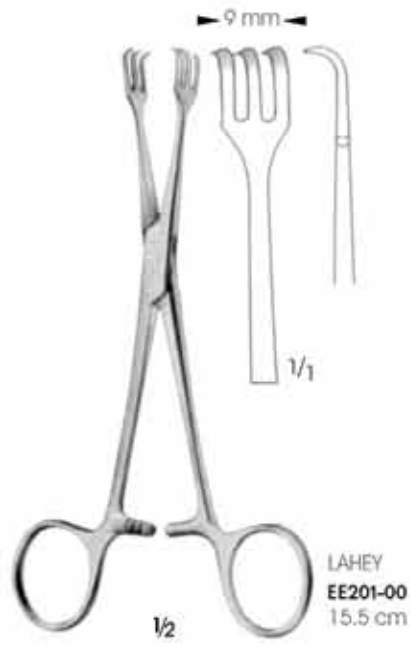
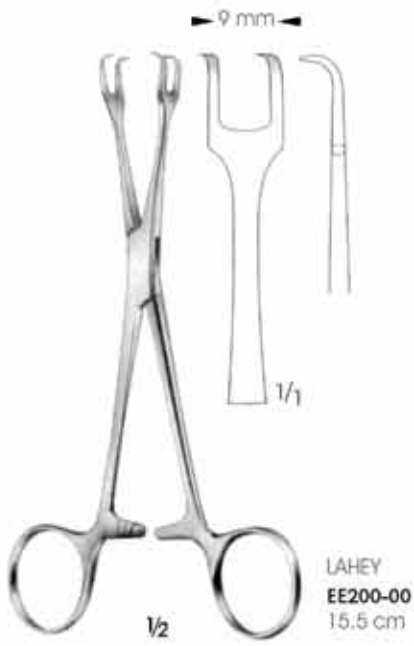

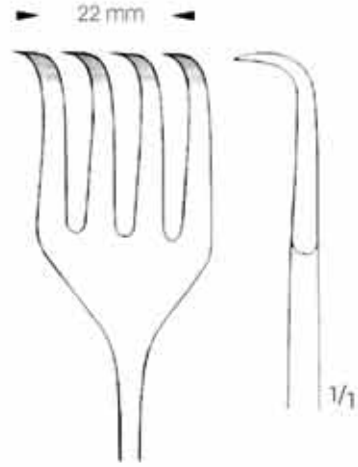
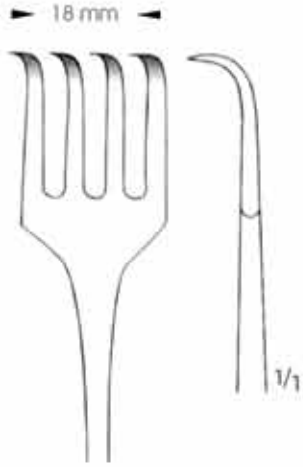

EE210-00
26 cm



PRAIT
EE211-00
27 cm

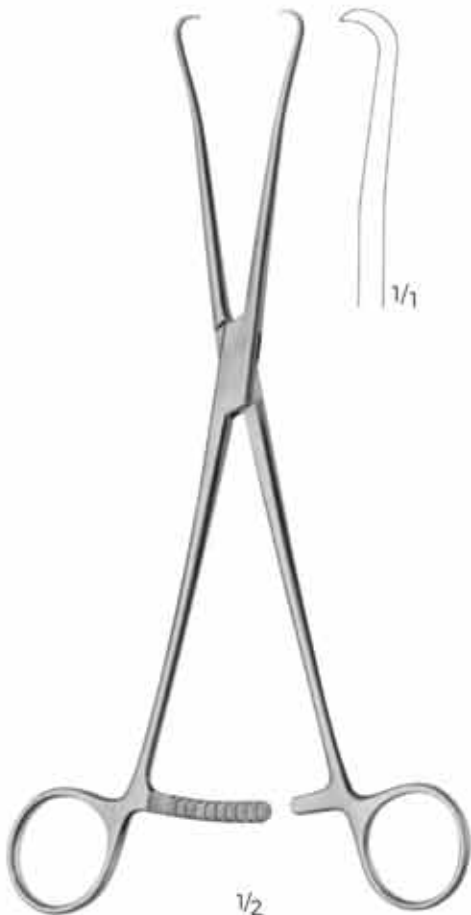

1/2
WILSON
EE252-00
24 cm



1/2
SCHRÖDER
EE251-00
25 cm



1/2
POZZI
EE255-01
25.5 cm



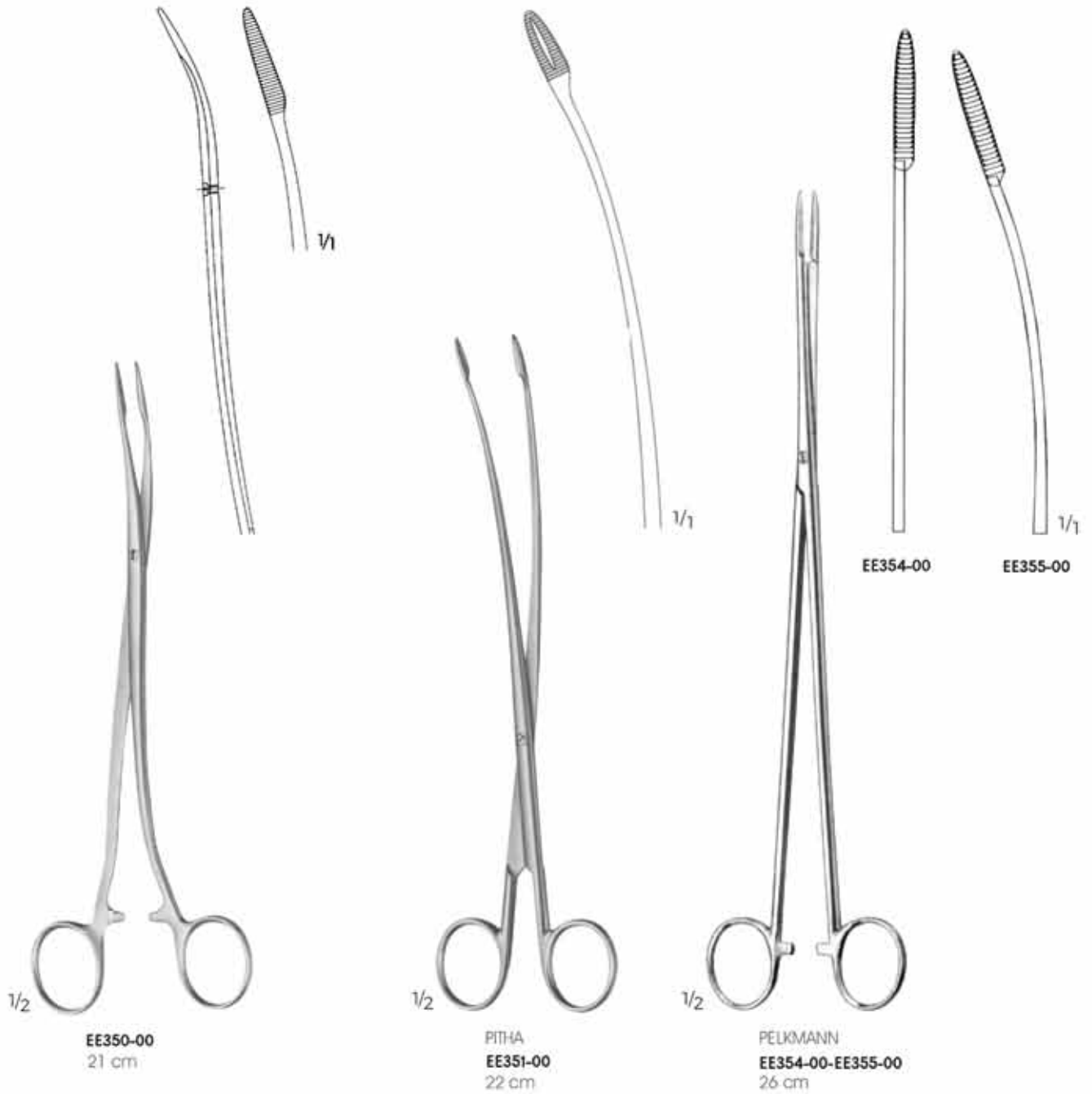



EE400-00
5.5 cm



ENGIL MOD
EE401-00
8.5 cm



JONES
EE402-00
8.5 cm



SCHAEDEL
EE403-00-EE404-00
8.5 cm



DOYEN
EE410-00
11 cm



DOYEN
EE412-00
18 cm



LANE
EE420-00-EE420-02



EE420-00
13 cm



EE420-01
15.5 cm



EE420-02
19.5 cm



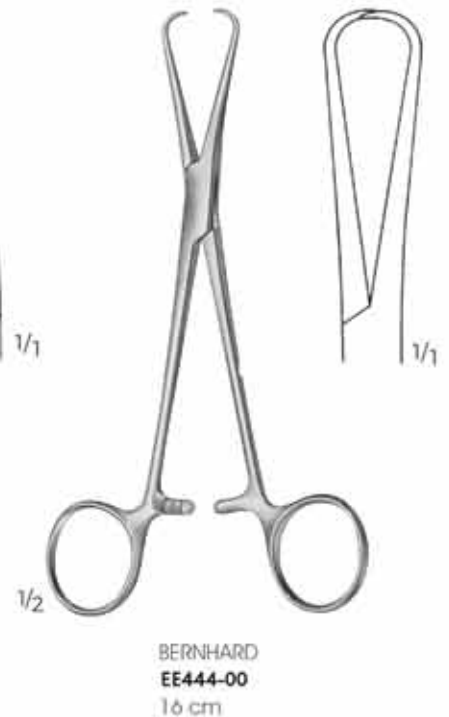
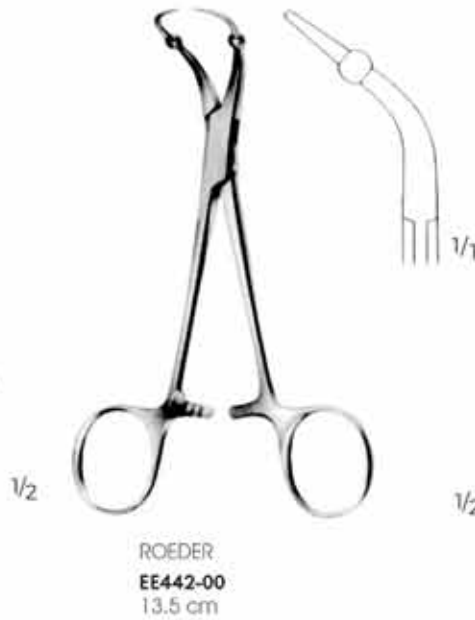
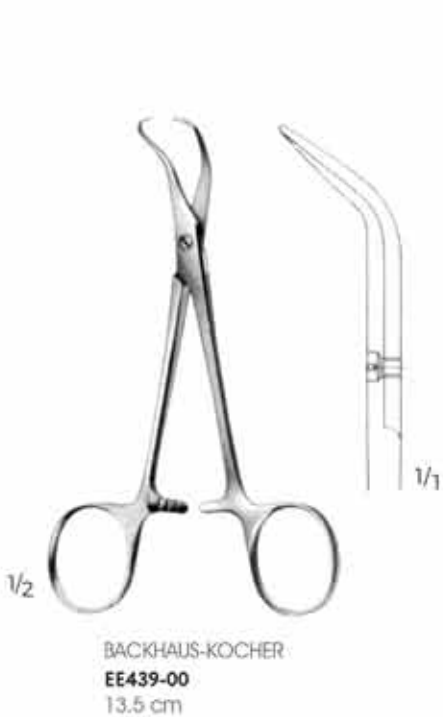
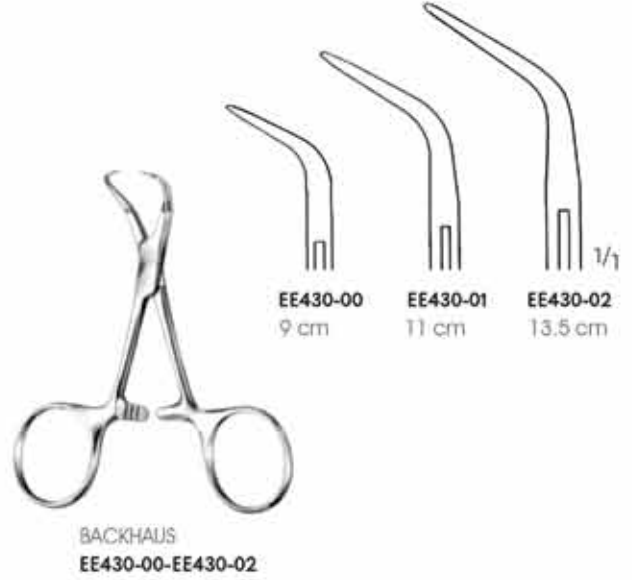
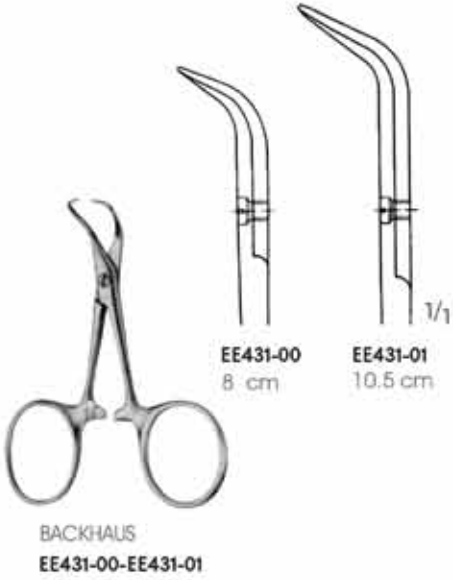



EE450-00
15 mm kadar tüp tutucu
With holders for tubing up to 15 mm
11 cm



ROBIN
EE451-01
13 mm kadar tüp tutucu
With holders for tubing up to 13 mm
13.5 cm



ROBIN
EE451-00
5 mm kadar kablo tutucu
With holders for cable up to 5 mm
13.5 cm

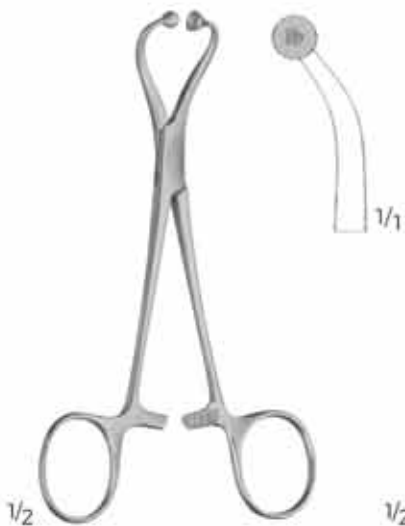

EE440-00
Kağıt örtüler için
For paper cloths
14 cm

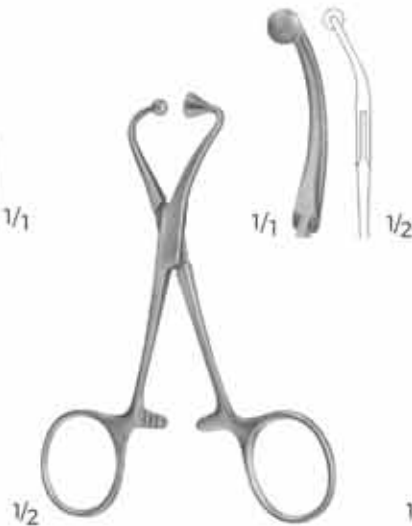

EE440-05
Kağıt örtüler için
For paper cloths
11.5 cm

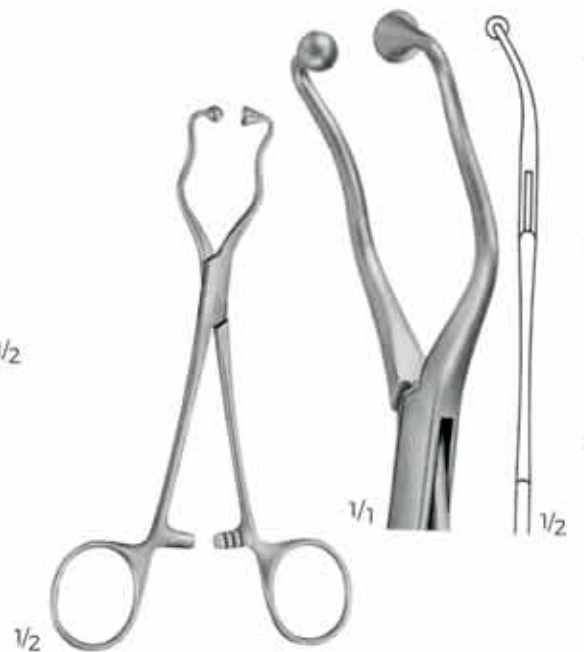

EE446-00
Tüp sabitleyici pens
Tube fixation forceps with
atraumatic jaw parts
14 cm





LORNA
EE460-00
Delmeden tutucu klempt
Non-perforating
9.5 cm

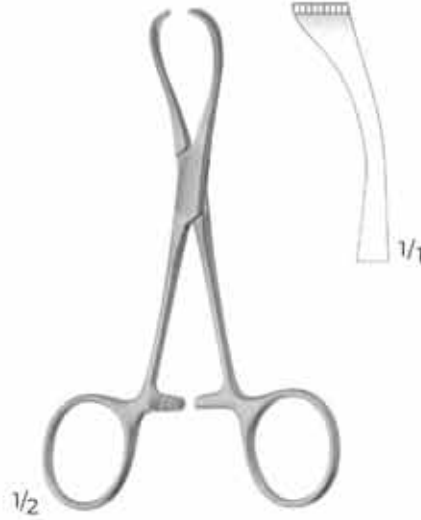

LORNA
EE461-01
Delmeden tutucu klempt
Non-perforating
13 cm

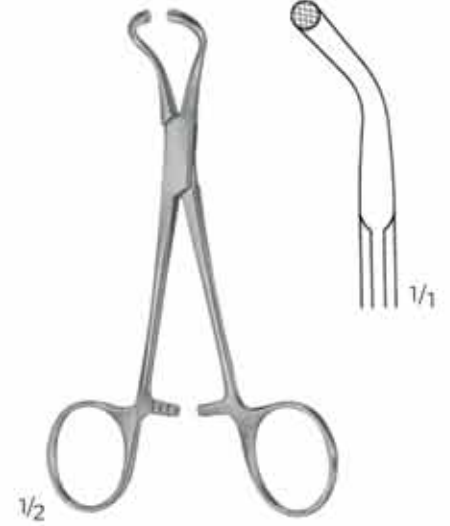

EE462-00
Bez örtüler için
For towel cloths
13.5 cm

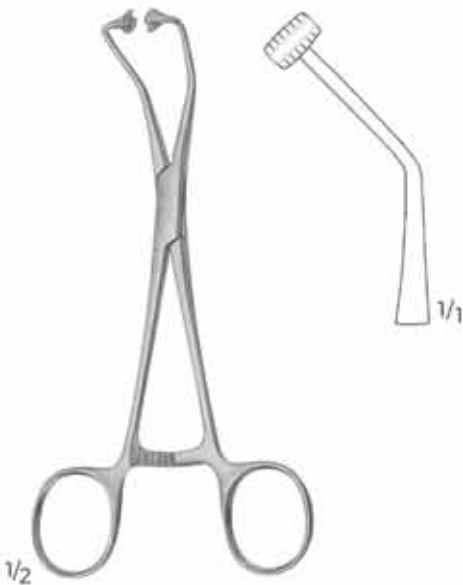

EE464-00
Kağıt örtüler için
For paper cloths
15 cm

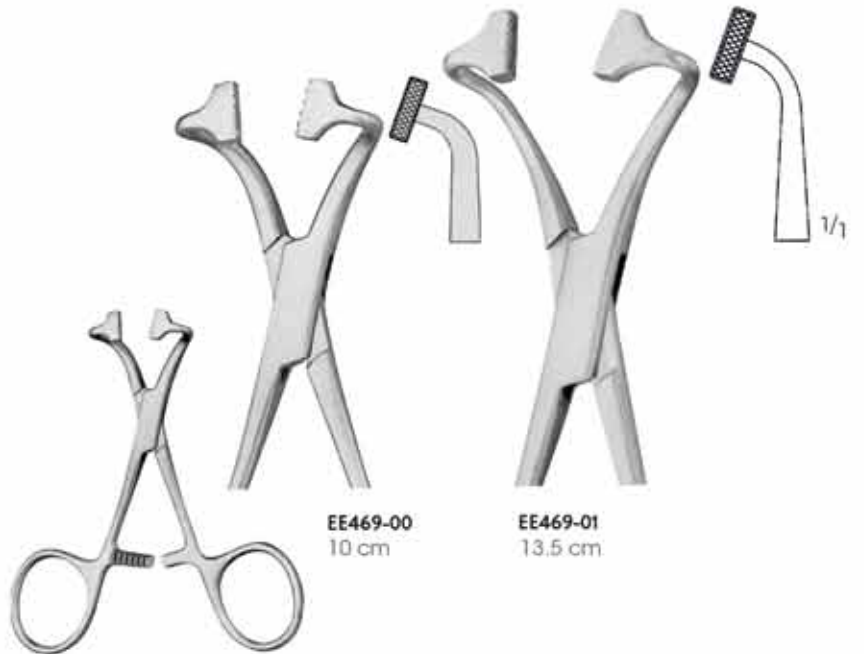

EE469-00
10 cm

EE469-01
13.5 cm

EE469-00-EE469-01
Delmeden tutucu klempt
Non-perforating



BUNT
EE480-00
10.5 cm

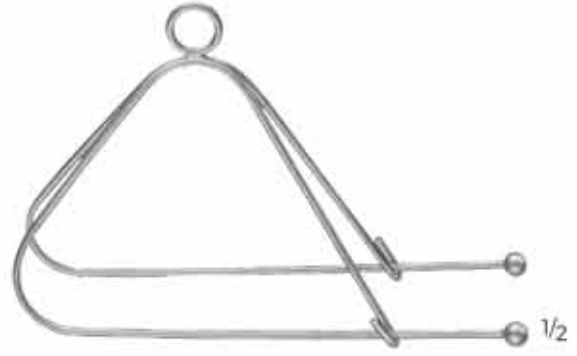

MAYO
EE482-00
Çift/double
12.5 cm



MAYO
EE481-00
14 cm



CHEATTLE
EE500-00
Sterilizasyon pens
Sterilizing forceps
28 cm

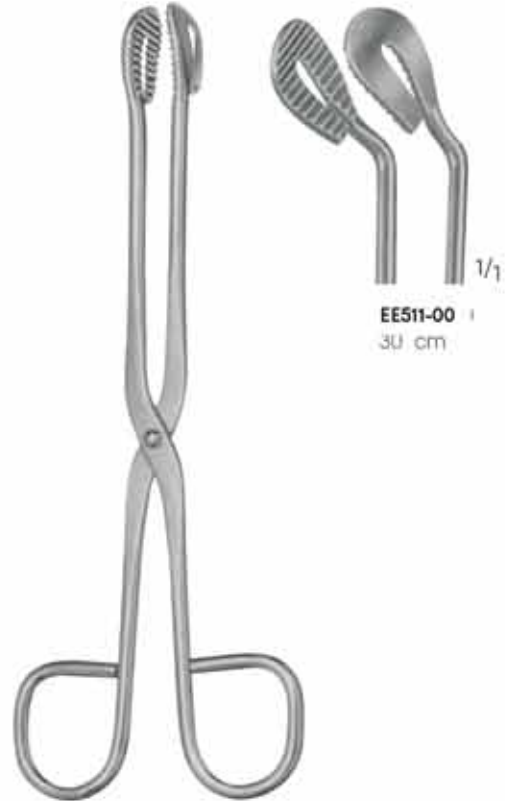

EE510-00 20 cm
EE510-01 30 cm
Sterilizasyon pensleri
Sterilizing forceps



EF

Portegüler ve Sütur Aletleri
Needle Holders and Suture Instruments



Düz Saplar/Flat Handles

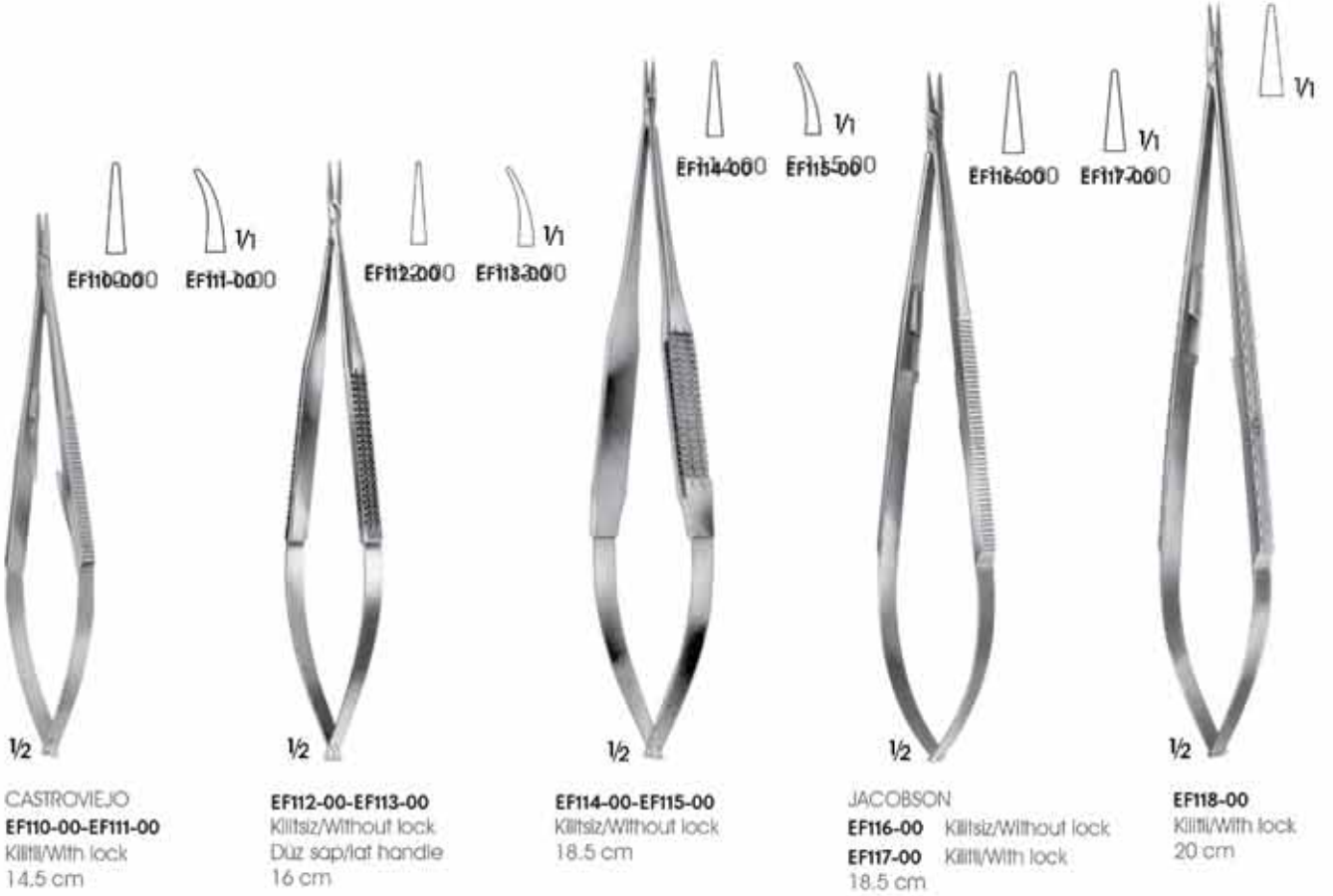

Ergonomik, hafif plastik sap
yorulmadan optimum kullanım
sağlar.

Ergonomic, light weight plastic
handle provides fatigue free,
optimal usage.

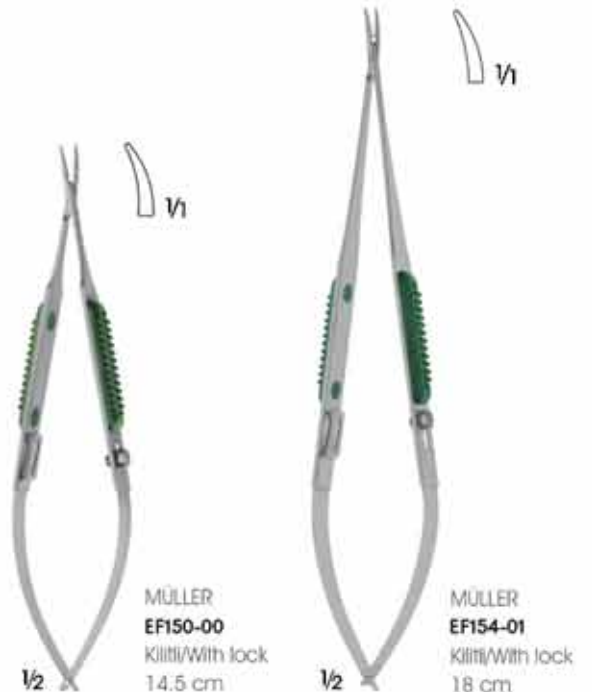

Yuvarlak Saplar

Parmaklar arasında istenildiği şekilde döndürmeye izin verir.

Sağlam veya oyulmuş saplardan dolayı her bir alette optimum denge sağlar

Round Handle

Allows rotation between the fingers as required
Due to carved and strong handle, each instrument provides optimum balance



RARRAÇI IFR
EF120-00-EF121-00
Kilitli/With lock
12 cm



RARRAÇI IFR
EF122-00-EF123-00
Kilitsiz/Without lock
12 cm



RARRAÇI IFR
EF130-00-EF131-00
Kilitsiz/Without lock
11,5 cm
12 cm



EF124-00-EF125-00
Kilitli/With lock
15 cm



RF III
EF126-00-EF127-00
Kilitsiz/Without lock
15 cm



EF132-00-EF133-00
Kilitsiz/Without lock
18,5 cm



EF134-00-EF135-00
Kilitli/ With catch
18,5 cm



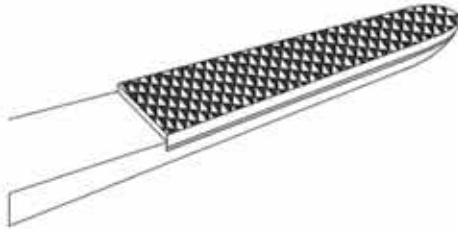

Elmas Uclu Portegüler :

Bahadır Portegülerinin ağızlarındaki elmas uçlarının kullanıma göre yüzey yapısı seçilebilir.

Bahadır elmas uclu portegülerinin 4 farklı yüzeyi vardır. Pürüzsüz yüzey ve 3 farklı çentik yüzeyi uygun iğne yakalamayı sağlar.

Needle holders with carbide inserts.

The carbide inserts on BAHADIR needle holders can be selected based on usage.

BAHADIR needle holders with carbide inserts have four different surface types. Smooth surface and three different notched surfaces provide appropriate needle catch.



Düz
smooth

Pürüzsüz yüzeye sahip ağızda kullanılacak, dikiş malzemesi için: 9/0 - 11/0

With smooth jaw surface for suture materials: 9/0 - 11/0



0,2

0.2 mm adimli çentiğe sahip ağızda kullanılacak, dikiş malzemesi için: 6/0 - 10/0

With 0.2 mm pitch of serration for suture material: 6/0 - 10/0



0,4

0.4 mm adimli çentiğe sahip ağızda kullanılacak, dikiş malzemesi için: 4/0 - 6/0

0.4 mm pitch of serration for suture material: 4/0 - 6/0



0,5

0.5 mm adimli çentiğe sahip ağızda kullanılacak, dikiş malzemesi için: 3/0' a kadar

0.5 mm pitch of serration for suture material: up to 3/0

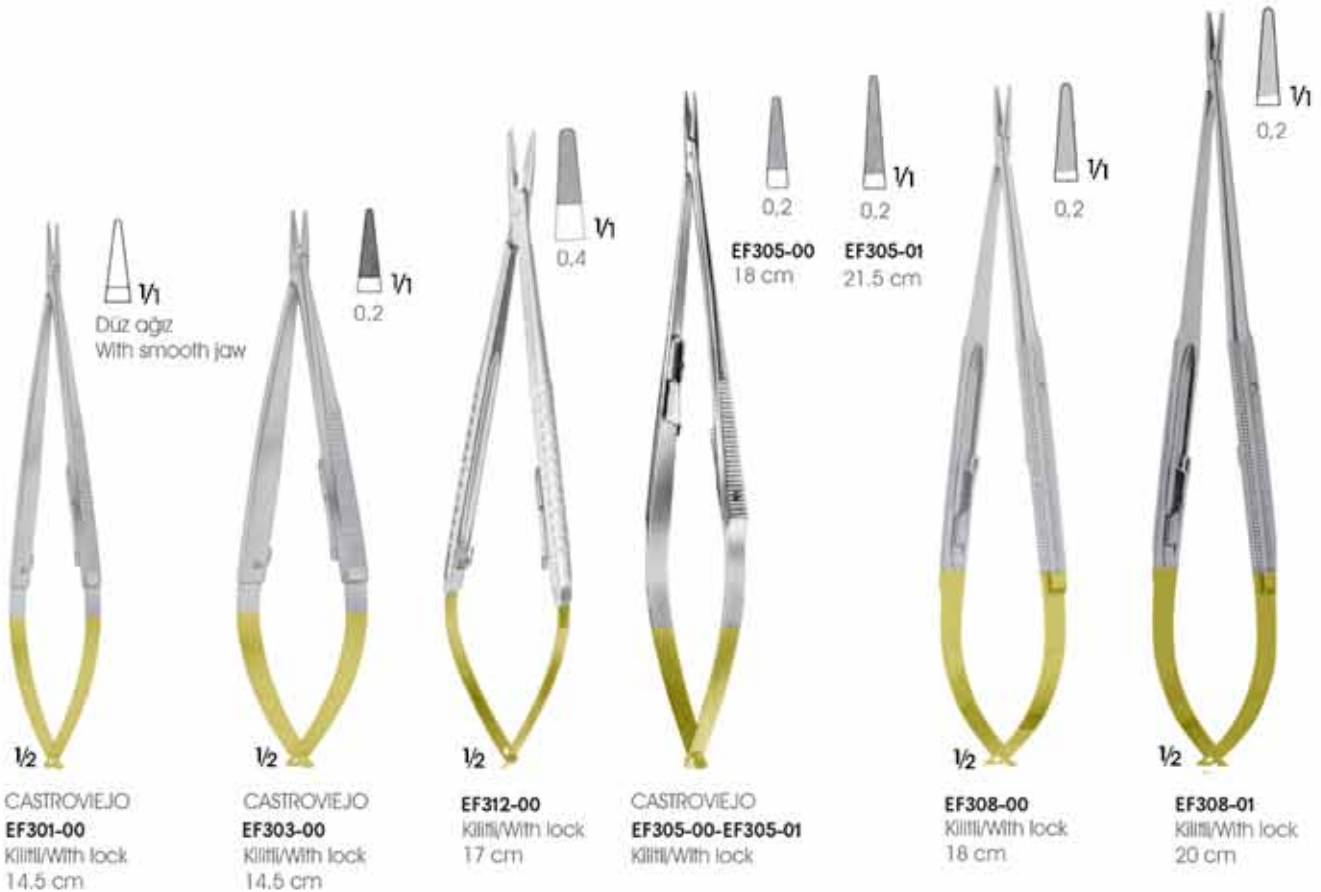



DIA MOTE ağızlar, daha sert ve aşınmaya dayanıklı yüzeyler sağlar.
DIA MOTE ağızlar, hassas iğne, suture ve dokuların güvenilir bir şekilde kavranmasını garanti eder.

DIA MOTE jaws provide harder and more wear resistant surfaces.
DIA MOTE jaws ensure reliable grip of fine needles, sutures and tissues.



EF307-00

EF307-04

1/2

EF307-00-EF307-04
Kilitli/With lock
18 cm



1/1

Suture 5-0 ve daha
küçükler için
For sutures 5-0
and smaller

1/2

EF310-36
Kilitli/With lock
21 cm



1/1

Suture 5-0 ve daha
küçükler için
For sutures 5-0
and smaller

1/2

EF310-37
Kilitsiz/Without lock
21 cm



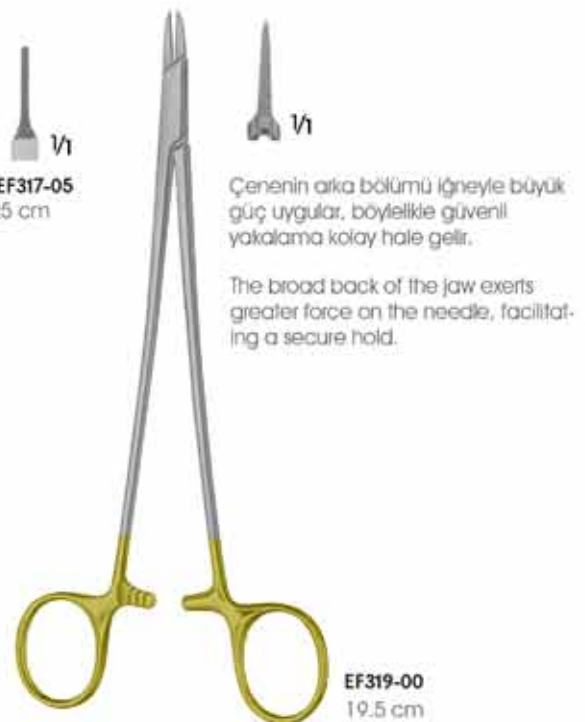
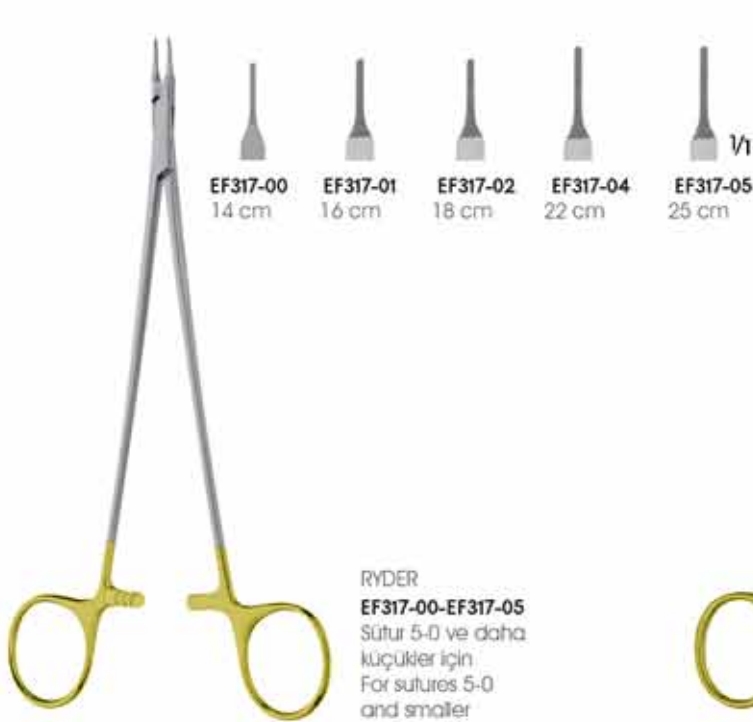



Sütür 7-0 ve daha
küçükler için
For sutures 7-0
and smaller

18.5 cm **EF312-01T**
21 cm **EF312-02T**
23 cm **EF312-04T**
Kilitli/With lock

18.5 cm **EF311-01T**
21 cm **EF311-02T**
23 cm **EF311-04T**
Kilitsiz/Without lock



Sütür 5-0 ve daha
küçükler için
For sutures 5-0
and smaller

18.5 cm **EF312-21T**
21 cm **EF312-22T**
23 cm **EF312-24T**
Kilitli/With lock

18.5 cm **EF311-31T**
21 cm **EF311-32T**
23 cm **EF311-34T**
Kilitsiz/Without lock





DIAMOTE ağızlar, daha sert ve aşınmaya dayanıklı yüzeyler sağlar.
DIAMOTE ağızlar, hassas iğne, suture ve dokuların güvenilir bir şekilde kavranmasını garanti eder.

DIAMOTE jaws provide harder and more wear resistant surfaces.
DIAMOTE jaws ensure reliable grip of fine needles, sutures and tissues.

Suture 7-0 ve daha küçükler için
For sutures 7-0 and smaller

Suture 5-0 ve daha küçükler için
For sutures 5-0 and smaller

Suture 7-0 ve daha küçükler için
For sutures 7-0 and smaller

Suture 5-0 ve daha küçükler için
For sutures 5-0 and smaller

Suture 4-0 ve daha küçükler için
For sutures 4-0 and smaller

Suture 4-0 ve daha küçükler için
For sutures 4-0 and smaller



12 cm EF310-01
14.5 cm -
16 cm EF310-02
18.5 cm EF310-03
21 cm EF310-04
23 cm EF310-05

EF310-01-EF310-10
Kilitli/Without lock



-
EF310-06
EF310-07
EF310-08
EF310-09
EF310-10



12 cm EF310-21
14.5 cm -
16 cm EF310-22
18.5 cm EF310-23
21 cm EF310-24
23 cm EF310-25

EF310-21-EF310-35
Kilitli/With lock



-
EF310-26
EF310-27
EF310-28
EF310-29
EF310-30



-
EF310-31
EF310-32
EF310-33



-
EF310-34
EF310-35

Suture 2-0 ve daha küçükler için
For sutures 2-0 and smaller



19 cm EF310-44
23 cm EF310-46
25 cm EF310-48

EF310-44-EF310-48
Kilitli/Without lock



Suture 2-0 ve daha küçükler için
For sutures 2-0 and smaller



19 cm EF310-45
23 cm EF310-47
25 cm EF310-49

EF310-45-EF310-49
Kilitli/With lock



Düz Sap/Flat Handle

Sütür 7-0 ve daha
küçükler için
For sutures 7-0
and smaller

Sütür 5-0 ve daha
küçükler için
For sutures 5-0
and smaller

Sütür 7-0 ve daha
küçükler için
For sutures 7-0
and smaller

Sütür 5-0 ve daha
küçükler için
For sutures 5-0
and smaller



EF311-02-EF311-06
Kilitli/Without lock

14.5 cm	-	EF311-03
17 cm	EF311-02	-
18.5 cm	-	EF311-04
21 cm	-	EF311-05
23 cm	-	EF311-06



EF311-12-EF311-16
Kilitli/With lock

14.5 mm	-	EF311-13
17 cm	EF311-12	-
18.5 cm	-	EF311-14
21 cm	-	EF311-15
23 cm	-	EF311-16

Kanallı Düz Sap/Flat Knurled Handle

Sütür 5-0 ve daha
küçükler için
For sutures 5-0
and smaller

Sütür 5-0 ve daha
küçükler için
For sutures 5-0
and smaller



EF311-20-EF311-22
Kilitli/Without lock

18.5 cm	EF311-20
21 cm	EF311-21
23 cm	EF311-22



EF311-25-EF311-27
Kilitli/With lock

18.5 cm	EF311-25
21 cm	EF311-26
23 cm	EF311-27



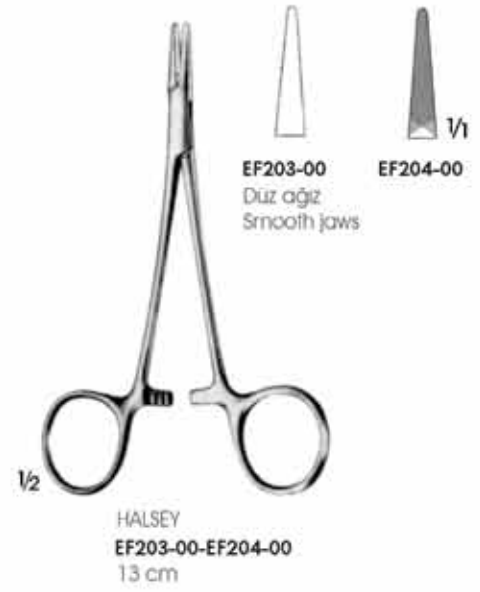



DOYEN
EF207-00
12.5 cm



Hassas operasyon için
Delicate pattern

CRILE-WOOD
EF215-00
15 cm

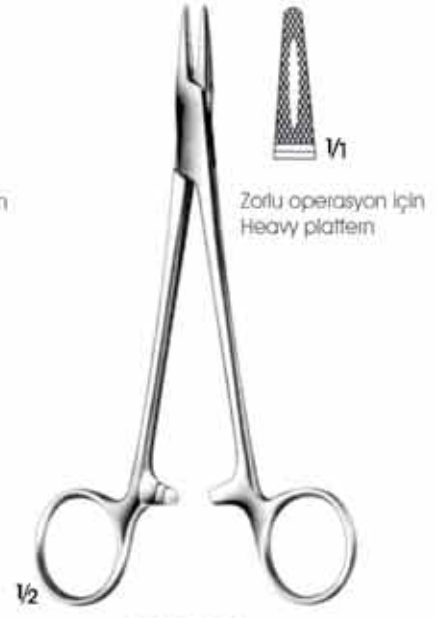

Zorlu operasyon için
Heavy pattern

CRILE-WOOD
EF217-00
16 cm



KILNER
EF221-00
13.5 cm



CRILE-MURRAY
EF219-00
15 cm



MAYO-HEGAR
EF223-00-EF223-03





MAYO-HEGAR
EF230-00-EF230-04
Orta incelikte dikiş pensisi
Medium fine patterns

HEGAR
EF231-00-EF232-04
Zorlu operasyon için
Heavy patterns

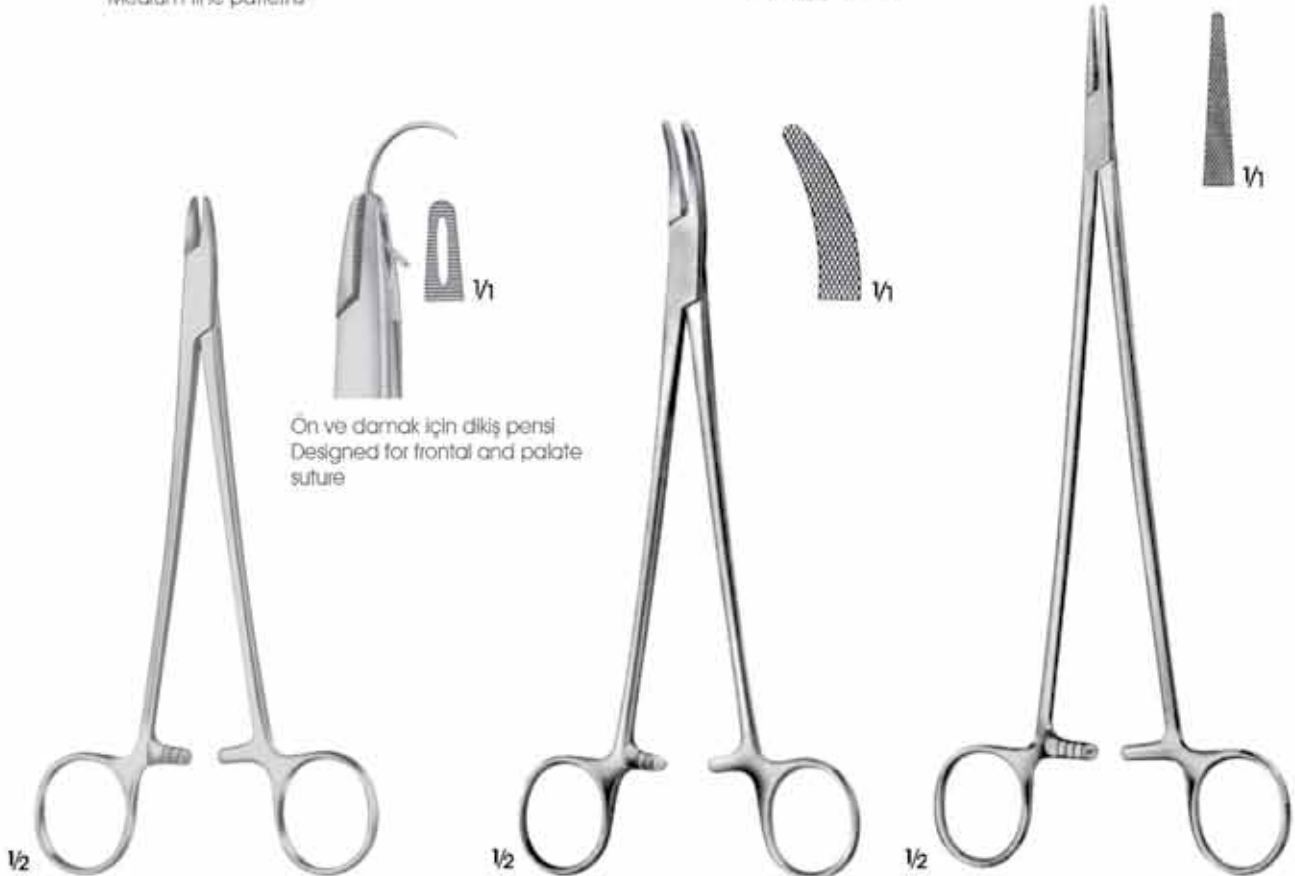

Ön ve damak için dikiş pensisi
Designed for frontal and palate
suture

ADSON
EF234-00
17.5 cm

HEANEY
EF236-00
20 cm

JAMESON
EF237-00
23 cm



WANGENSTEEN
EF238-00
27.5 cm



MASSON
EF239-00
26.5 cm

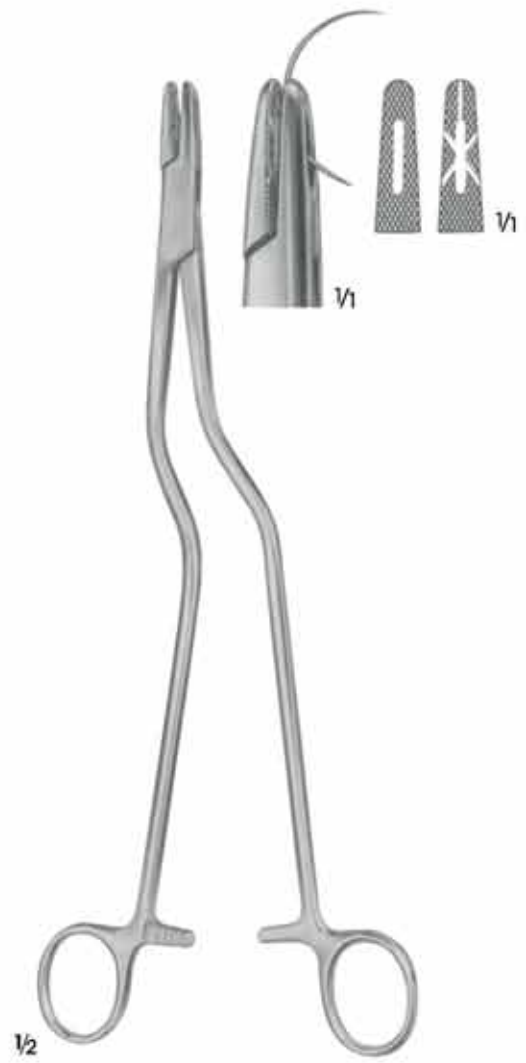

MASSON-LUETHY
EF240-00
25.5 cm





HEGAR-OLSEN
EF260-00-EF261-00



EF260-00
14 cm



EF261-00
18.5 cm



GILLIES
EF268-00
15 cm



GILLIES
EF269-00
16 cm





CRILE
EF250-00
15 cm



TÖNNIS
EF251-00
Dura ve bağırsak dikiş pensi
Elastic pattern for dura-or intestinal suture
18 cm



MATHIEU
EF285-00-EF285-02



MATHIEU -STILLE
EF290-00-EF290-01
Çok zorlu operasyon için
Very heavy patterns



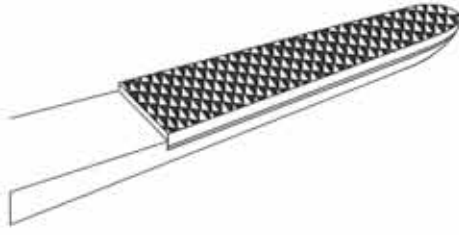

Elmas Uclu Portegüler :

Bahadır Portegülerinin ağızlarındaki elmas uçlarının kullanıma göre yüzey yapısı seçilebilir.

Bahadır elmas uclu portegülerinin 4 farklı yüzeyi vardır. Pürüzsüz yüzey ve 3 farklı çentik yüzeyi uygun iğne yakalamayı sağlar.

Needle holders with carbide inserts.

The carbide inserts on BAHADIR needle holders can be selected based on usage.

BAHADIR needle holders with carbide inserts have four different surface types. Smooth surface and three different notched surfaces provide appropriate needle catch.



Düz
smooth

Pürüzsüz yüzeye sahip ağızda kullanılacak, dikiş malzemesi için: 9/0 - 11/0

With smooth jaw surface for suture materials: 9/0 - 11/0



0,2

0,2 mm adimli çentikle sahip ağızda kullanılacak, dikiş malzemesi için: 6/0 - 10/0

With 0,2 mm pitch of serration for suture material: 6/0 - 10/0



0,4

0,4 mm adimli çentikle sahip ağızda kullanılacak, dikiş malzemesi için: 4/0 - 6/0

0,4 mm pitch of serration for suture material: 4/0 - 6/0



0,5

0,5 mm adimli çentikle sahip ağızda kullanılacak, dikiş malzemesi için: 3/0' a kadar

0,5 mm pitch of serration for suture material: up to 3/0



HALSEY
EF320-00
12 cm



Düz ağız
With smooth jaw



WEBSTER
EF321-00-EF321-01
12,5 cm



EF321-00
Düz ağız
With smooth jaws



EF321-01
0,4



MASING
EF322-00
Tek ayağı açılı, yüzüklü
One ring angled
13 cm



0,4



DERF
 EF323-00
 11.5 cm



HALSEY
 EF325-00
 13 cm



CONVERSE
 EF326-00
 13 cm



KILNER
 EF330-00
 13.5 cm



BABY-CRILE-WOOD
 EF328-00
 15 cm



BAUMGARTNER
 EF332-00
 14.5 cm

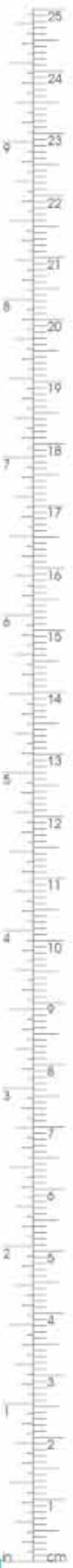



CRILE-WOOD
EF333-00-EF333-05



SAROT
EF338-00-EF338-05



DE BAKEY
EF344-00-EF345-01
Çok hassas/Very delicate

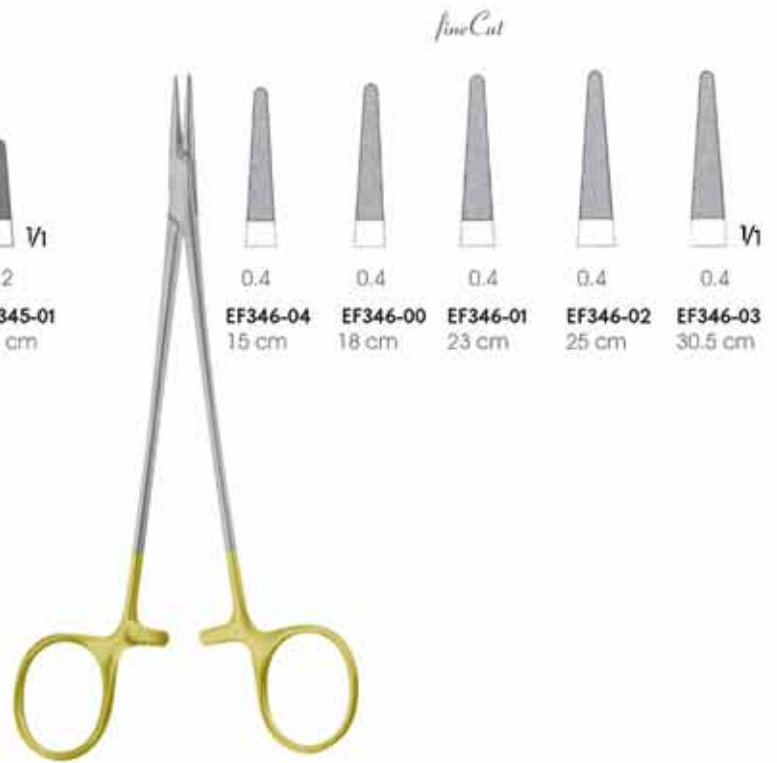

DE BAKEY
EF346-00-EF346-04

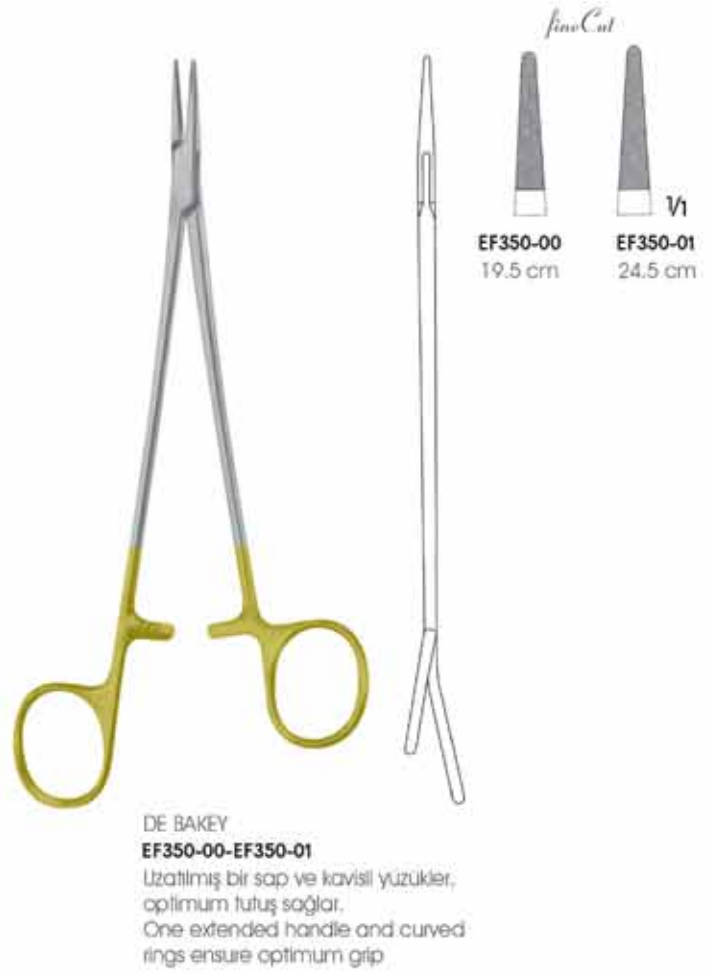



HEGAR-MAYO
EF355-00-EF355-04

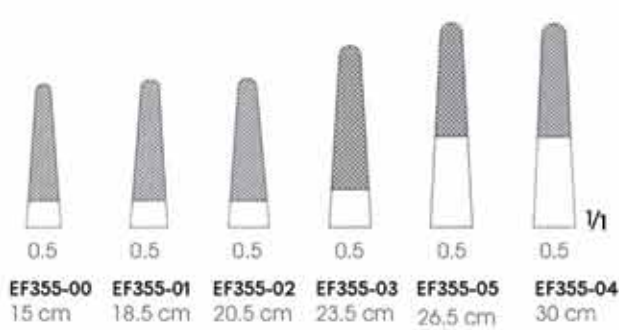

HEGAR
EF357-00-EF357-01
Zorlu operasyon için
Heavy patterns



EF340-00
 12.5 cm



HEGAR-HELSON
EF341-00
 14.5 cm



GILLIES
EF342-00
 16 cm

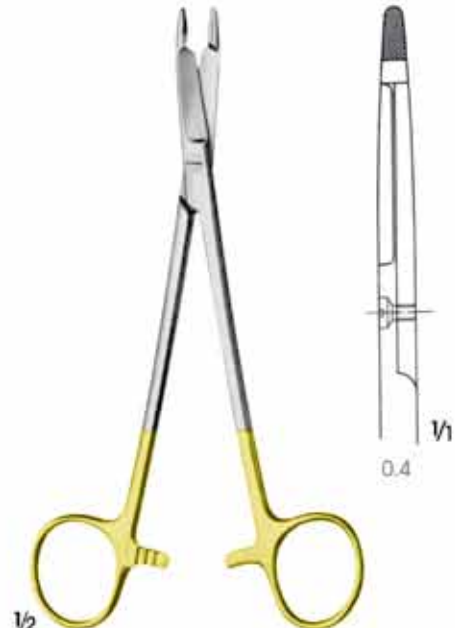

HEGAR-OLSEN
EF343-01
 Tek ağız tırtıllı
 one blade fine serrated
 16.5 cm





EF334-00
Tel bükücü/Wire twister
15 cm



EF336-00
Tel bükücü/Wire twister
15 cm



EF337-01
Tel Bükücü/ Wire twister
Sternum suture için ligatür pens
Sternum suture for ligature forceps
17.6 cm



BERRY
EF335-00
Tel bükücü/Wire twister
Ligatür pens/Ligature forceps
18.5 cm



BAUMGARTNER
EF339-01
Tel bükücü/Wire twister
Ligatür pens/Ligature forceps
20 cm



WERTHEIM
 EF370-00-EF370-02

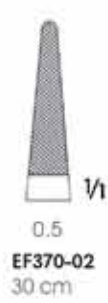

HEANEY
 EF373-00-EF373-02

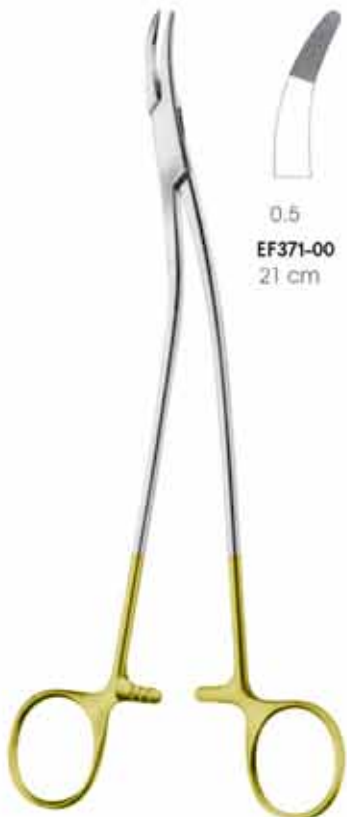
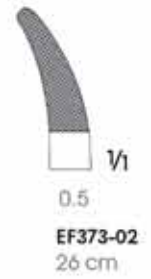

STRATTE
 EF371-00-EF371-01

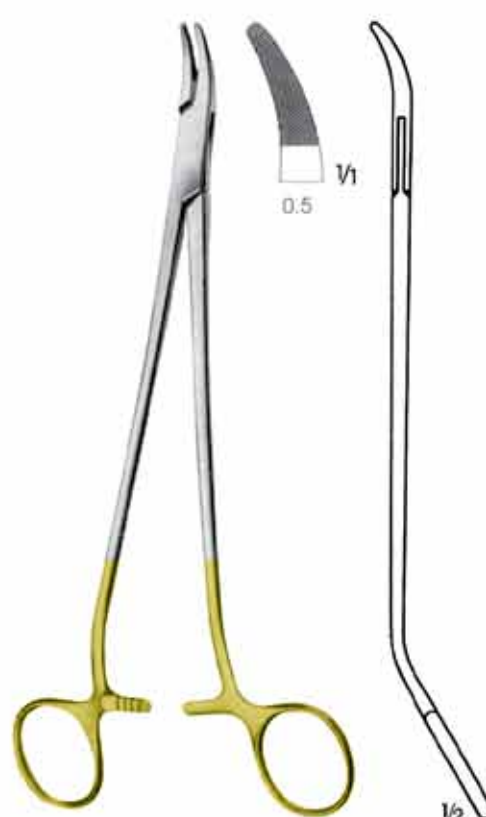
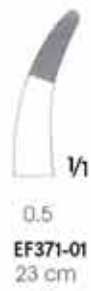

EF374-00
 S şekli portegu/S-shaped needle
 21.5 cm



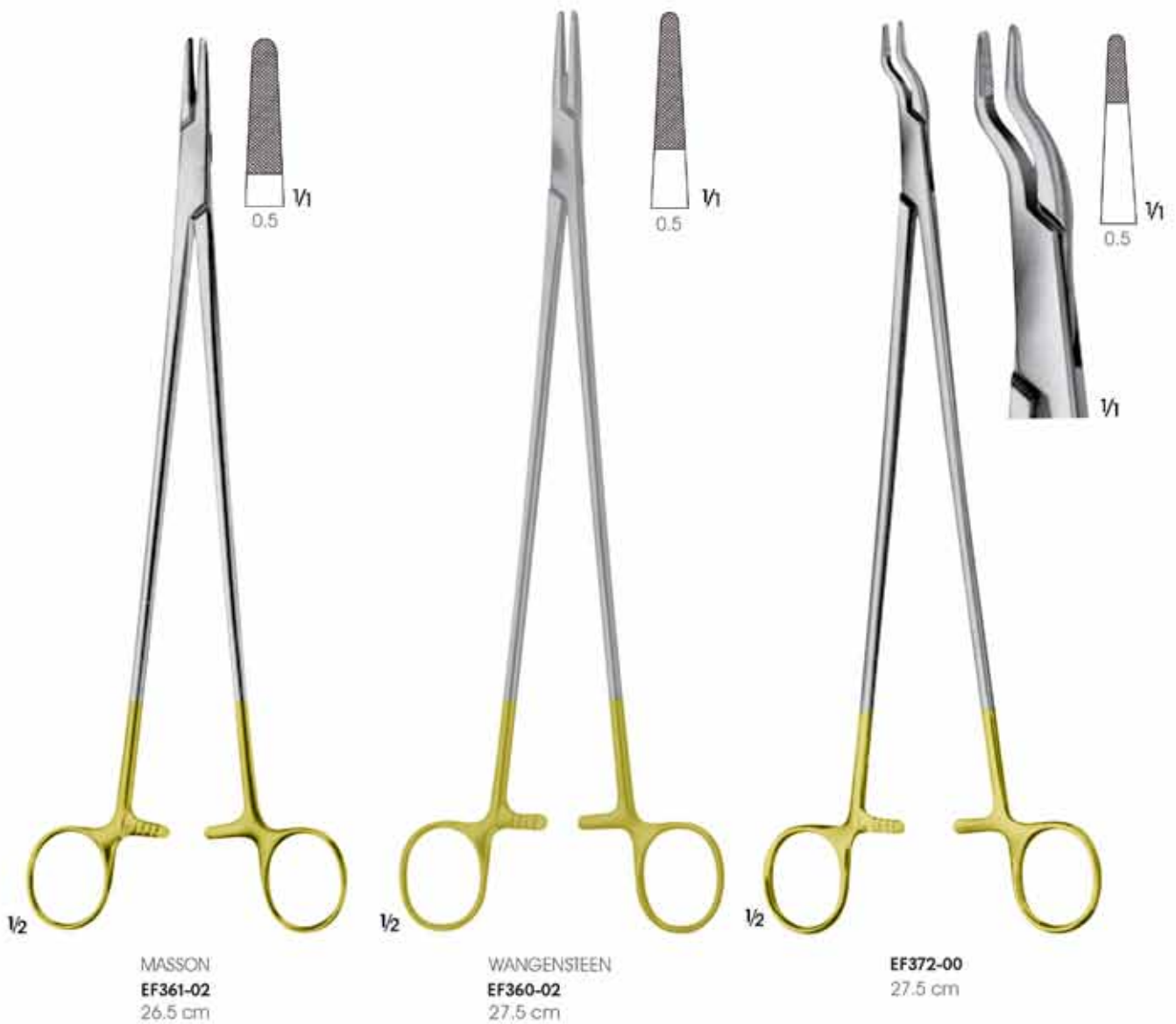



1/2
FINOCHIETTO
EF363-02
26.5 cm



1/2
NAUNTON-MORGAN
EF353-00
26 cm



1/2
MÜLLER
EF354-00
Derin rektum cerrahisi için
For deep rectum surgery
36 cm



- Hassas çeneler travmatik olmayan ve hassas damar iğnelerini tutmak için uygundur.
- Fine jaws are suitable for gripping non-traumatic needles and vein needles.



RYDER
EF380-00-EF380-04
Çok hassas/Very delicate

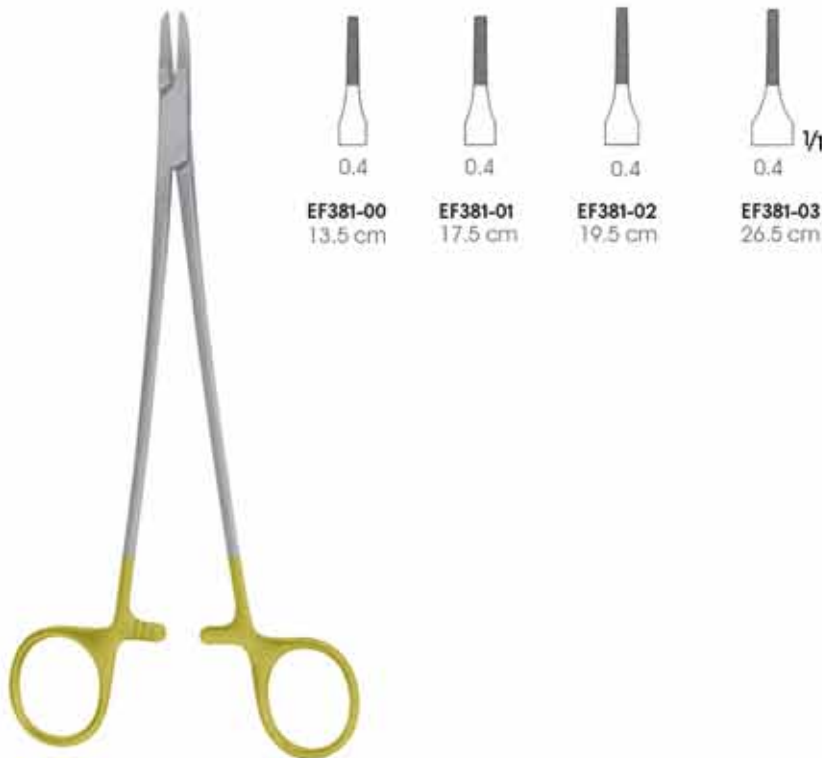

RYDER
EF381-00-EF381-03



RYDER
EF324-00-EF324-02
Düz ağız/With smooth jaws



EF324-00
15 cm



EF324-01
18 cm



EF324-02
23 cm



1/2

EF385-01
18 cm



0.4

V1



1/2

EF385-00
20 cm



0.4

V1



- Cerraha maksimum ergonomik rahatlık sağlar.
- Optimize tasarımları sayesinde zor suture ve anastomoz tekniklerinde yorulmadan çalışmayı sağlar.
- Provides maximum ergonomic comfort to surgeon.
- Due to optimized design, it provides fatigue free working on suture and anastomosis techniques.



REIN-KUPKA
EF382-00
Kilitli/Without ratchet lock
19 cm



REIN-KUPKA
EF383-00
Kilitli/ With ratchet lock
19 cm



HELLBERG-KUPKA
EF388-00
Kilitli/ With ratchet lock
21 cm

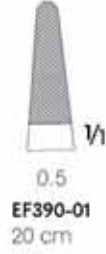

LANGENBECK
EF390-00-EF390-01



LANGENBECK
EF391-00
 Elastik model/Elastic pattern
 20 cm



TÖNNIS
EF387-00
 Elastik model/Elastic pattern
 18 cm



TÖNNIS
EF384-00
 Elastik model/Elastic pattern
 18 cm



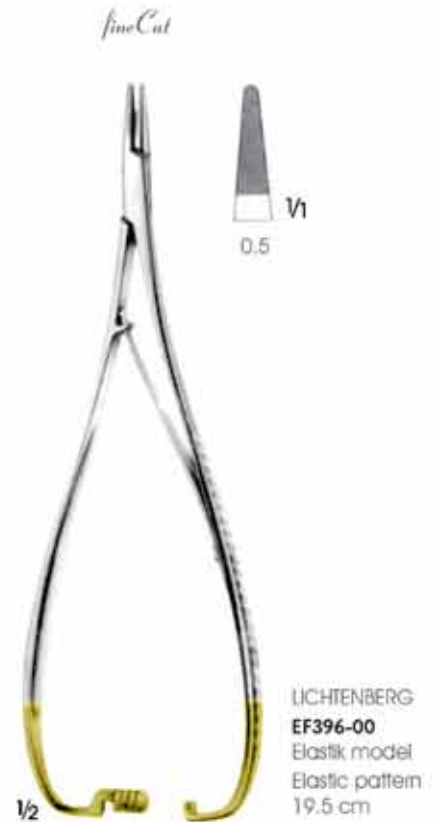
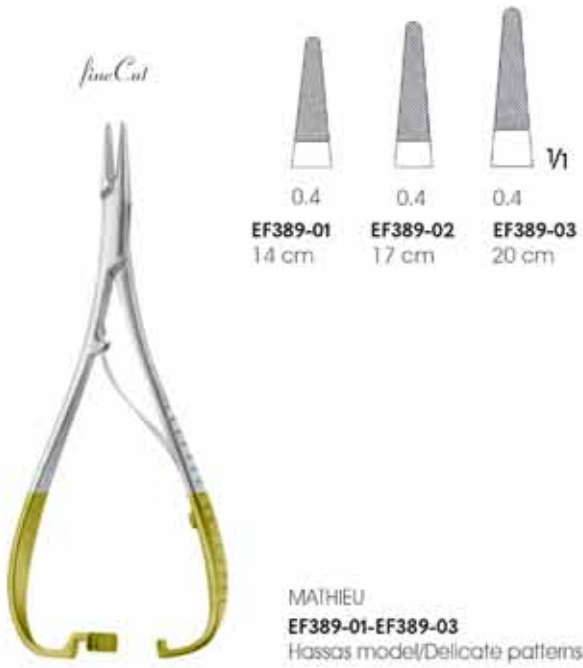

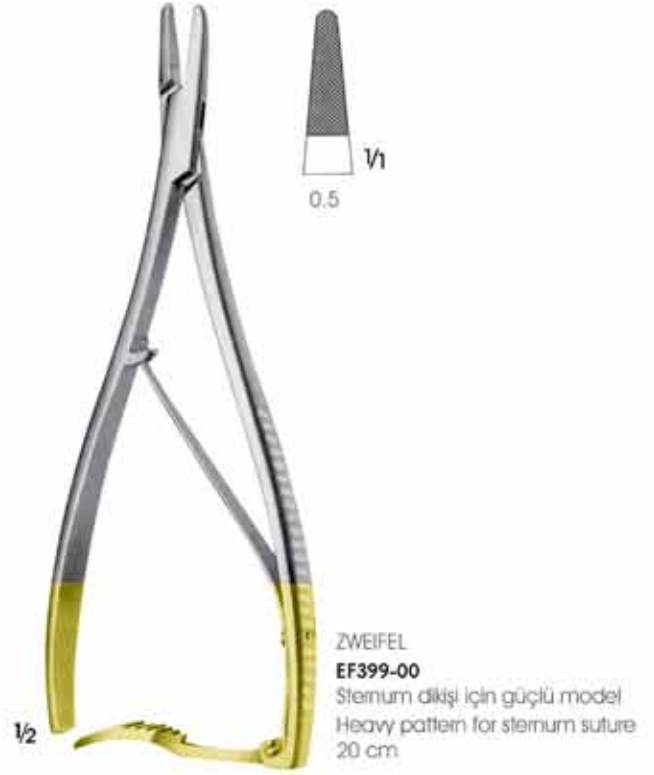



YOUNG-HRYNTSCHAK
EF406-00
1 iğne ile F 400.00
With 1 needle F 400.00
24 cm



MILLIN
EF408-00
Ligatür tutucu pens
Ligature holding forceps
28.5 cm

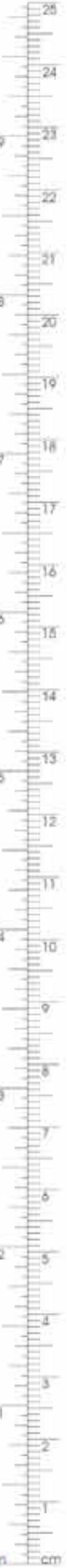
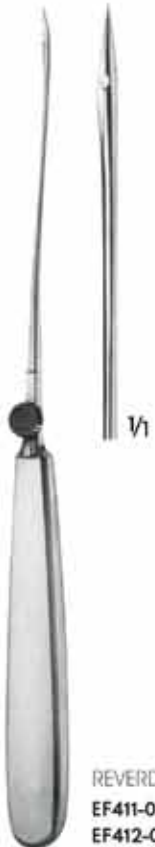

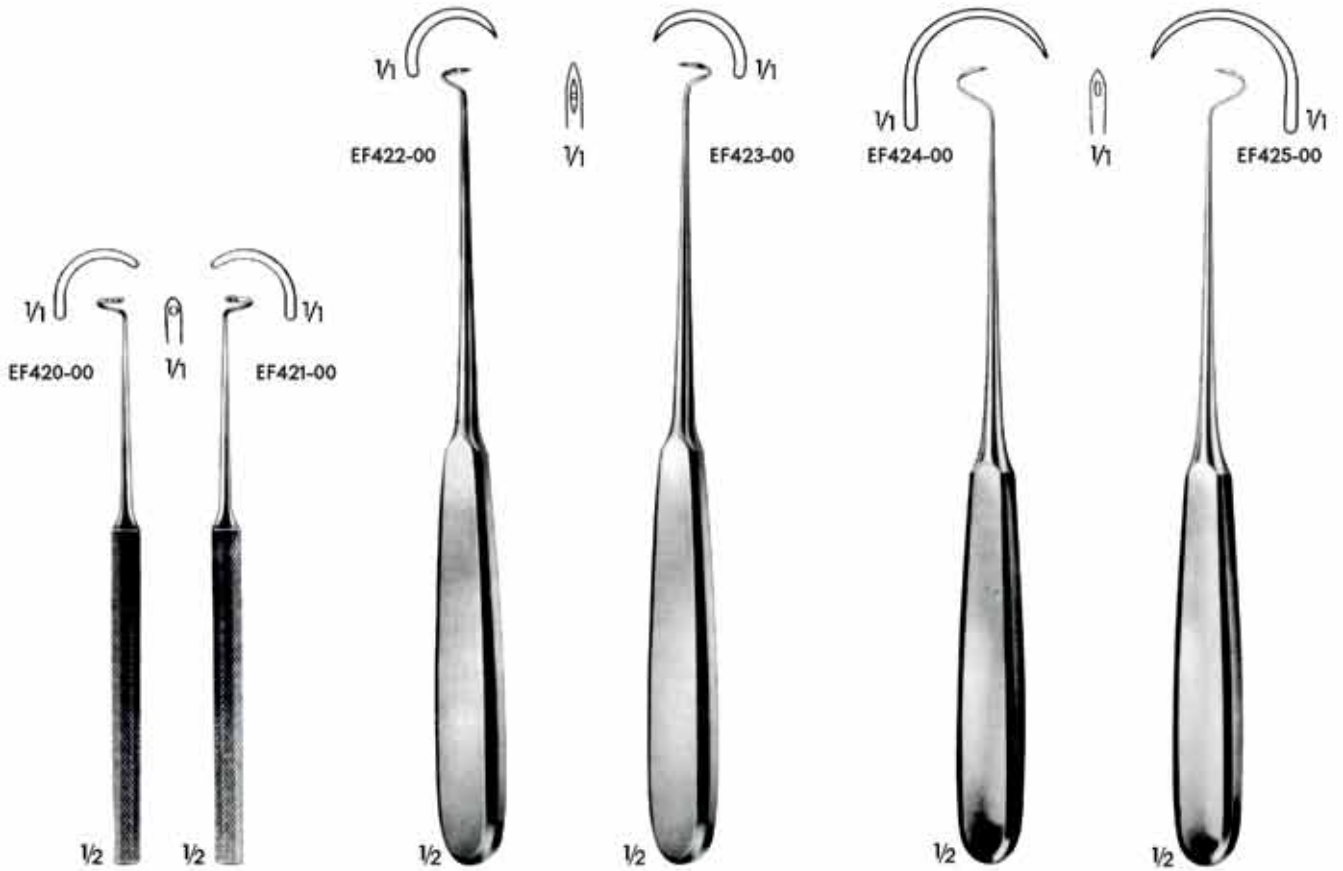

KRONECKER
EF420-00
Sağ el için, künf
For right hand blunt
EF421-00
Sol el için, künf
For left hand blunt
15.5 cm

DESCHAMPS
EF422-00
Sağ el için, sivri
For right hand sharp
EF423-00
Sol el için, sivri
For left hand sharp
21 cm

HURD
EF424-00
Sağ el için, sivri
For right hand sharp
EF425-00
Sol el için, sivri
For left hand sharp
21 cm

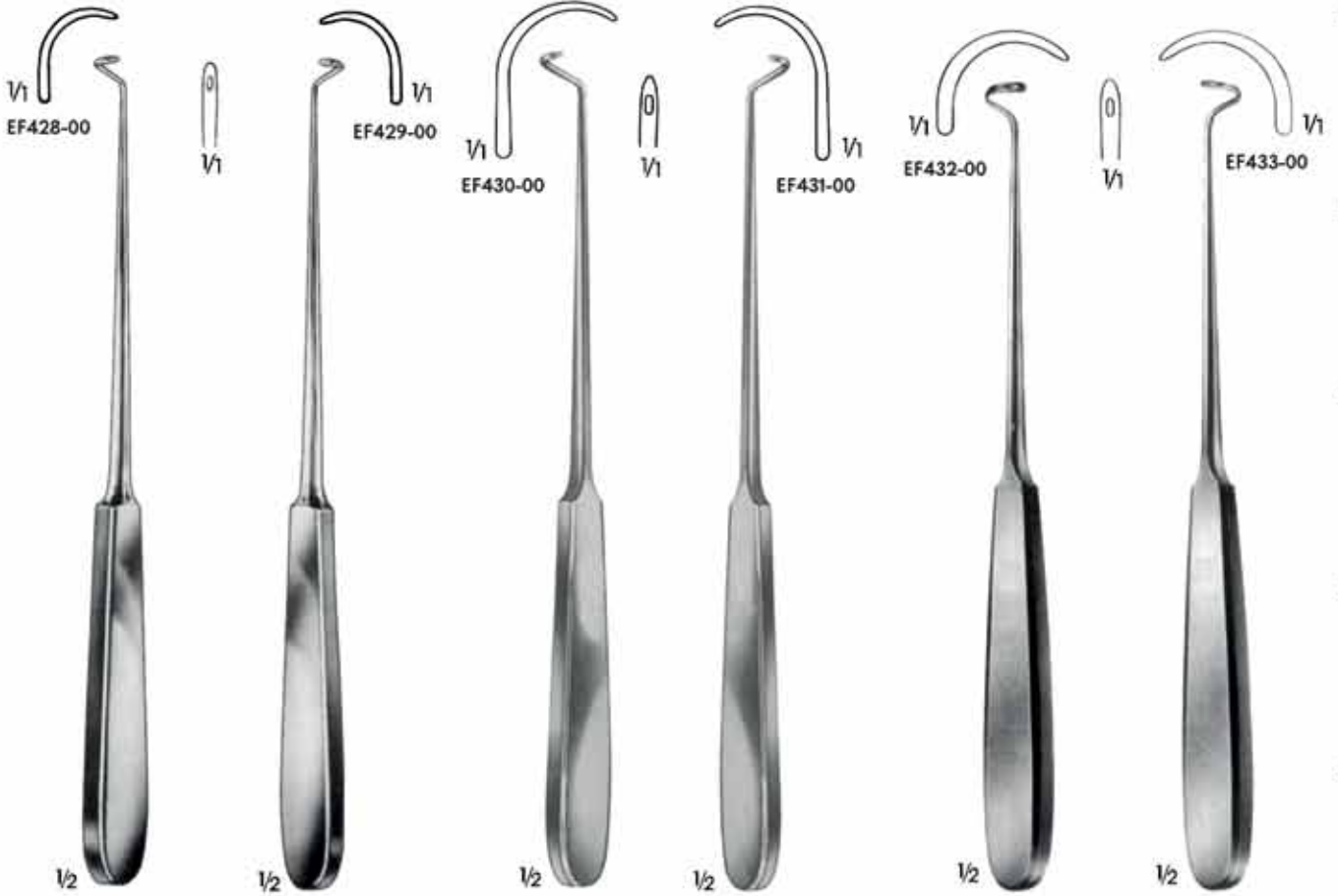

DESCHAMPS
EF428-00
Sağ el için, künt
For right hand blunt
EF429-00
Sol el için, künt
For left hand blunt
22.5 cm

DESCHAMPS
EF430-00
Sağ el için, künt
For right hand blunt
EF431-00
Sol el için, künt
For left hand blunt
22.5 cm

DESCHAMPS
EF432-00
Sağ el için, künt
For right hand blunt
EF433-00
Sol el için, künt
For left hand blunt
21.5 cm

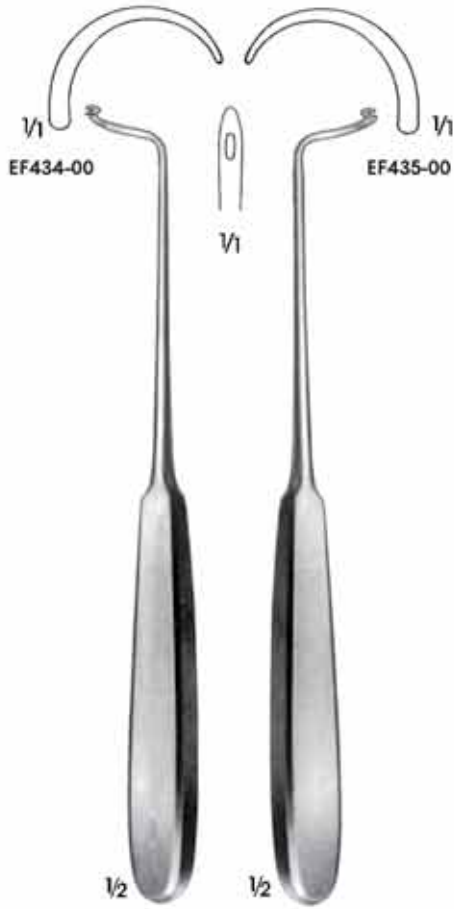

DESCHAMPS
EF434-00
Sağ el için, künt
For right hand blunt
EF435-00
Sol el için, künt
For left hand blunt
21 cm



DESCHAMPS
EF445-00
Sağ el için, sivri
For right hand sharp
EF446-00
Sol el için, sivri
For left hand sharp
21.5 cm

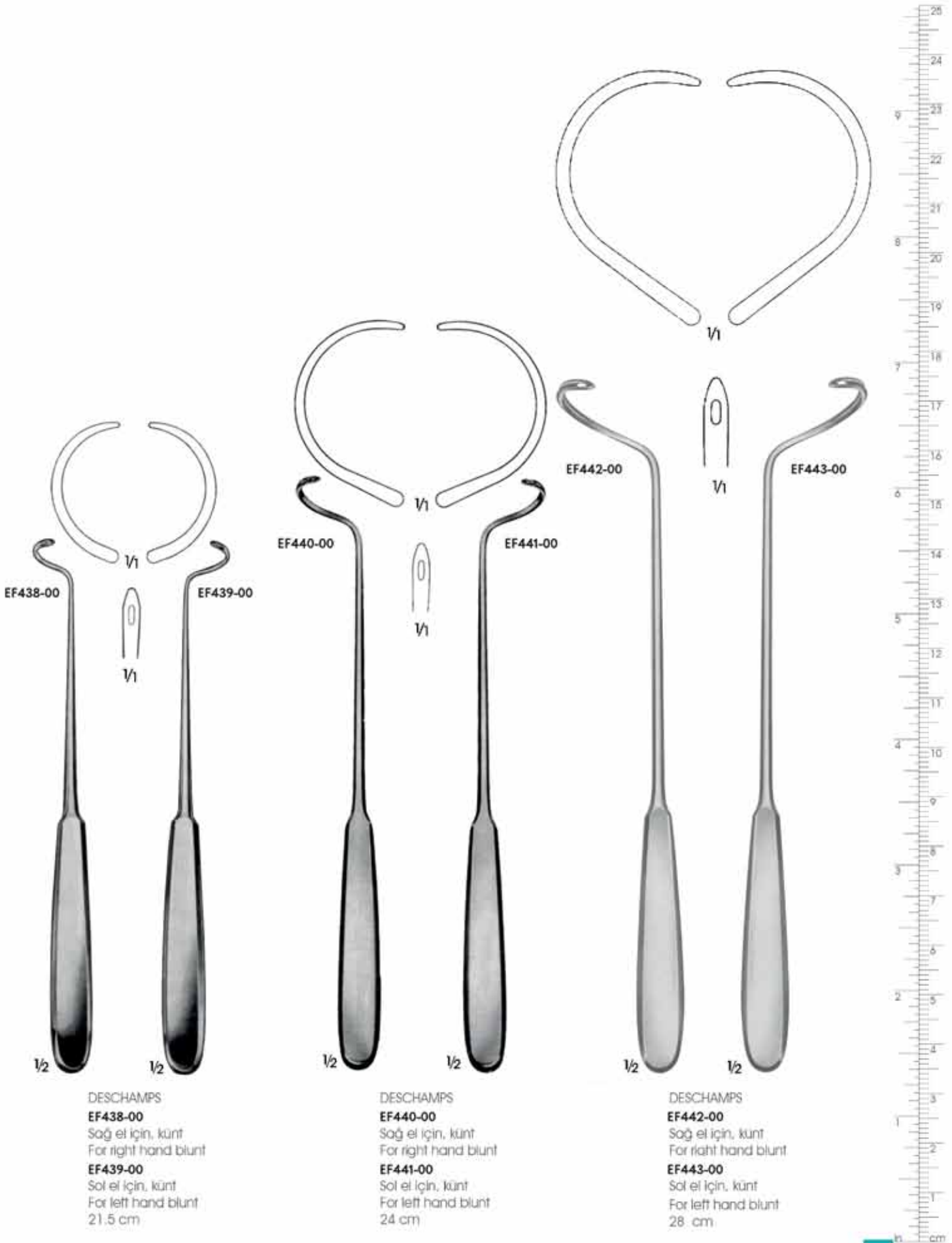

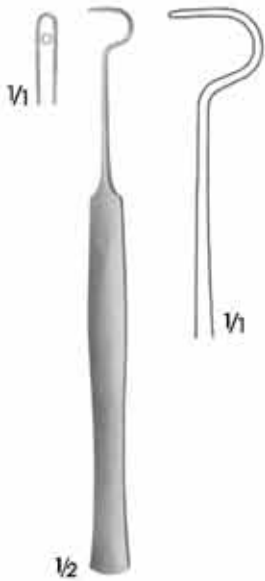

EF450-00
15 cm



SYME
EF454-00
17 cm



JONESCO
EF453-00
Dikiş telli klavuzu
Needle for wire suture
18.5 cm

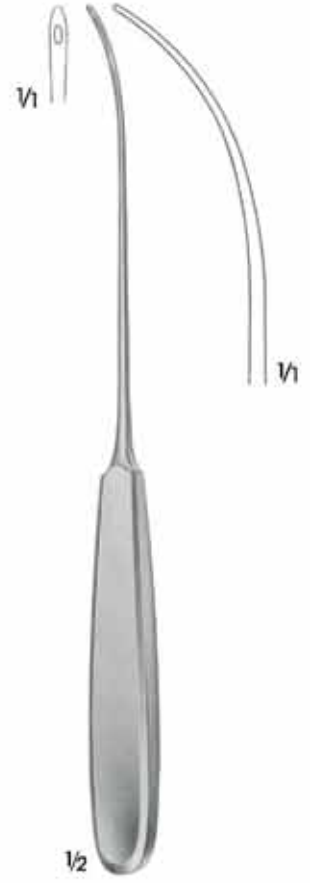

EF460-00
Bükülebilir/Malleable
23 cm



CLAUS VAN EICKEN
EF451-00
25 cm



COOPER
EF455-00
20.5 cm

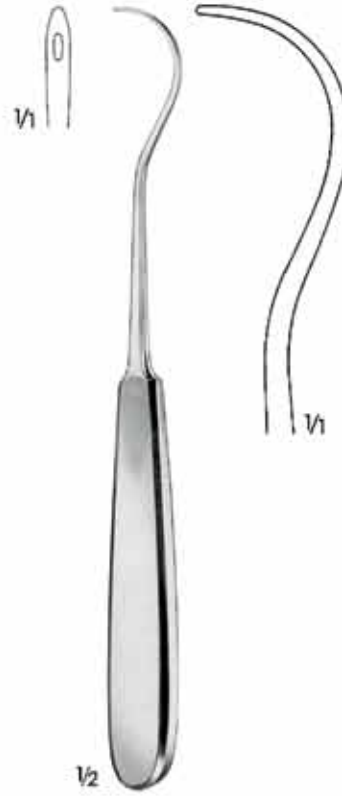

KOCHER
EF456-00
20.5 cm

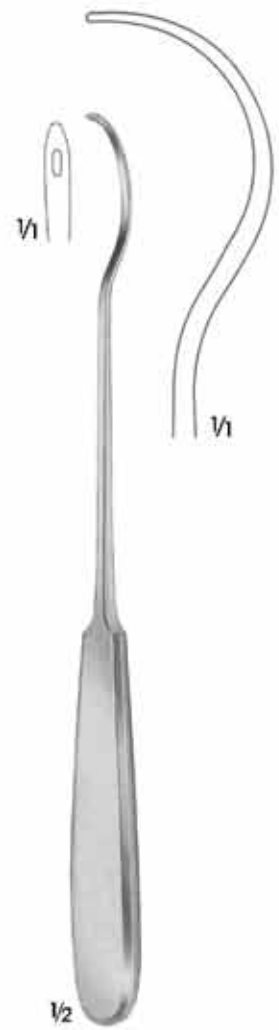

BRUNNER
EF461-00
24 cm





EF465-00



EF465-01

BRUNNER
EF465-00-EF465-01
Kilavuz sondaları/Guiding probes
30 cm

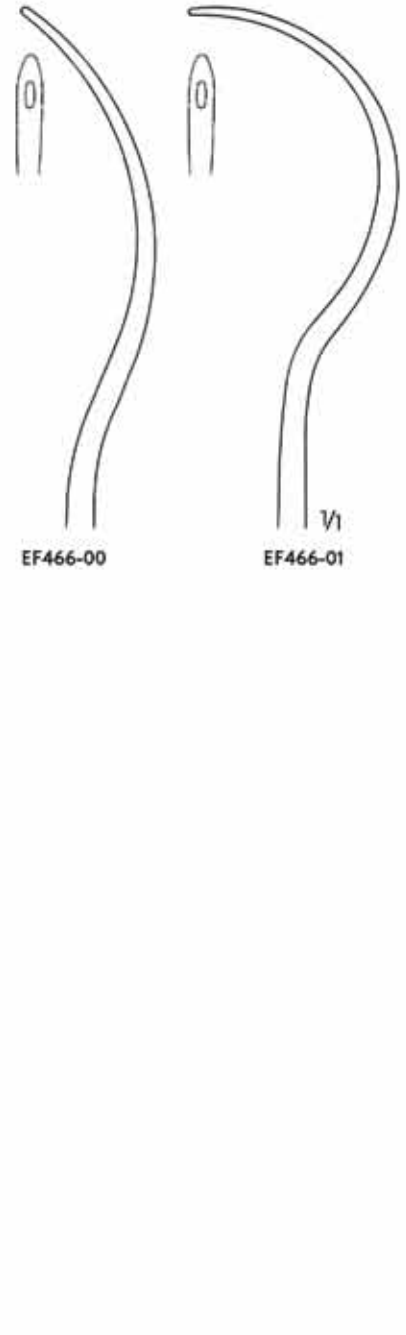

EF466-00



EF466-01

BRUNNER
EF466-00-EF466-01
Bağlama iğneleri/Ligature needles
30 cm



EF480-00
20 cm



KÖNIG
EF481-00
19.5 cm



KÖNIG
EF482-00
20 cm



SCHIMEDEN
EF483-00
18.5 cm

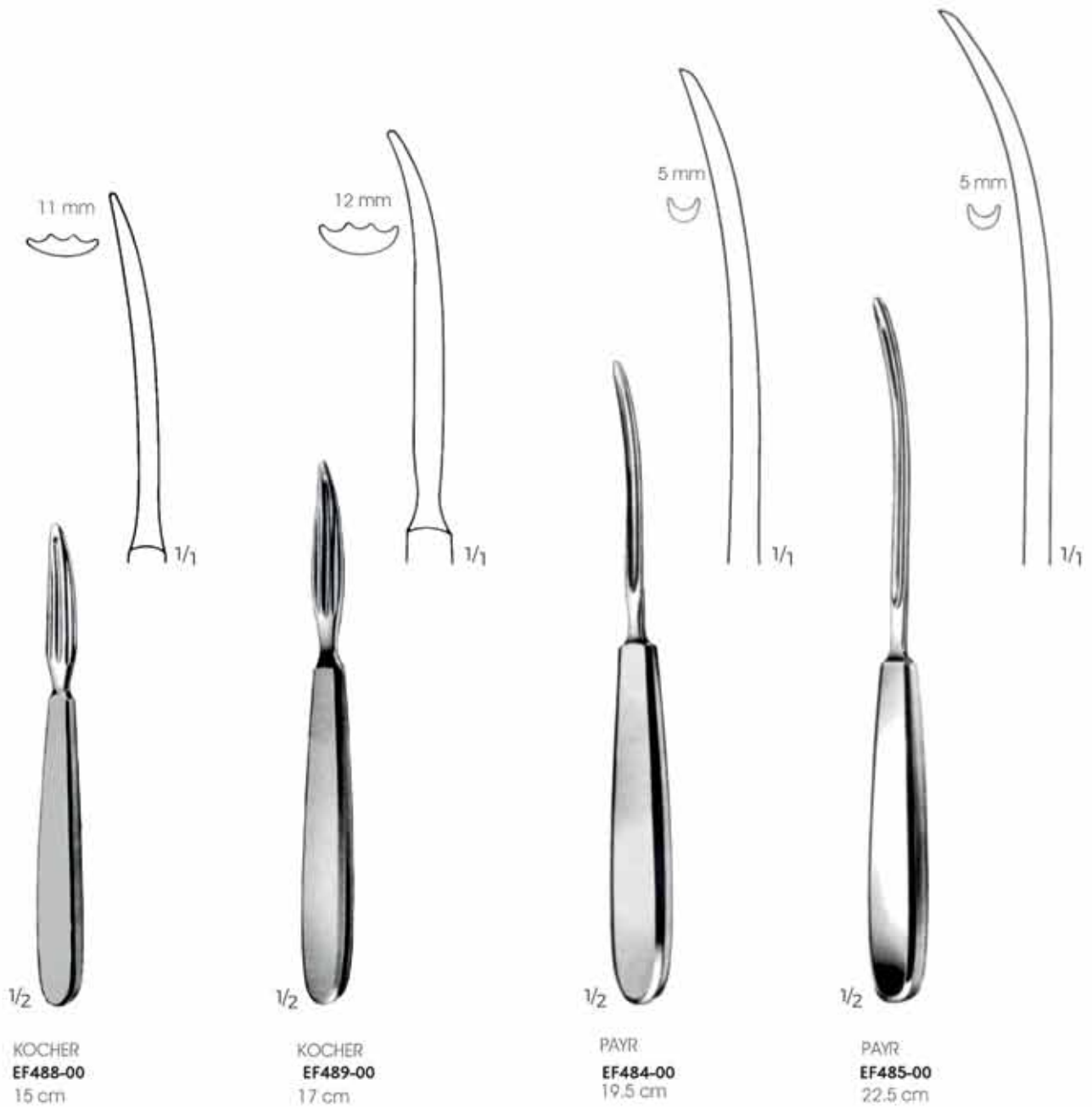

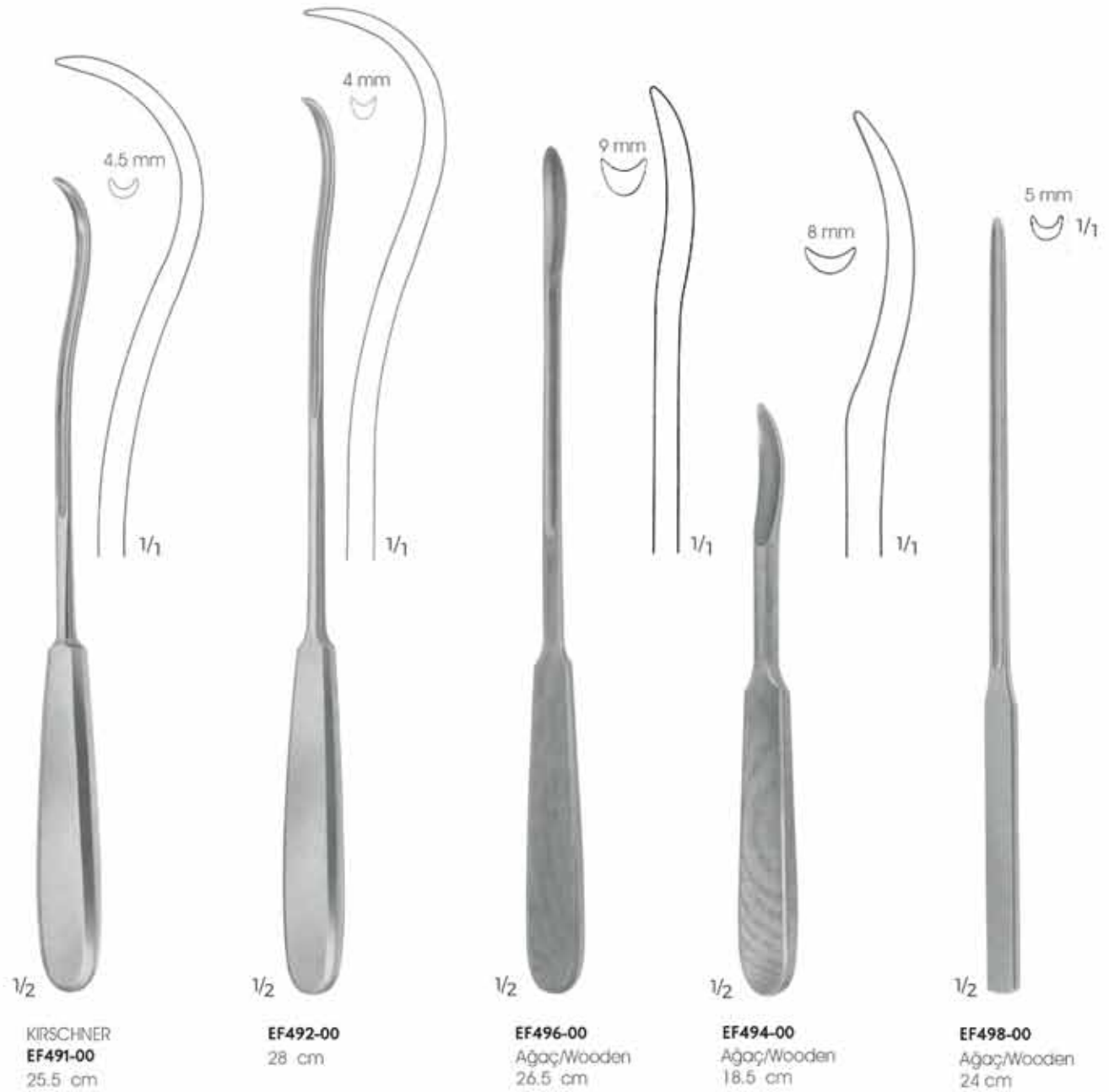



1/2
HEGENBARTH
EF601-00
Klip uygulayıcı penset
Clip applying forcep
12 cm



1/2
MICHEL
EF605-00
Klip uygulayıcı penset
Clip applying forcep
12.5 cm



1/2
MICHEL
EF620-00
Klip uygulayıcı ve çıkarıcı pens
Clip applying and removing forcep
12.5 cm



1/2
MICHEL
EF621-00
Klip uygulayıcı ve çıkarıcı pens
Clip applying and removing forcep
13 cm



1/2
COLLIN
EF630-00
Klip çıkarıcı pens
Clip removing forcep
13.5 cm



1/2
HEATH
EF631-00
Klip çıkarıcı pens
Clip removing forcep
13.5 cm



1/2
ET083-00
Düğüm aparatı
Attachment node
23 cm



1/2
CASPAR
ET084-02
Düğüm aparatı
Attachment node
23 cm



EF952-00
50 x 25 x 5 mm
EF952-01
50 x 30 x 6 mm
EF952-04
70 x 25 x 5 mm



EF950-00
60 x 25 x 11 mm
EF950-01
70 x 53 x 9 mm



EF954-00
150 x 90 x 10 mm



EF956-00
205 x 120 x 12 mm



EF960-00 65 x 16 mm İç kutu ve dış kutu takımı/Needle case with interior box
EF962-00 95 x 16 mm İç kutu ve dış kutu takımı/Needle case with interior box
EF964-00 65 x 16 mm F 960.00 için sadece dış kutu/Exterior box of F 960.00
EF961-00 62 x 17 mm F 960.00 için iç kutu/Interior box of F 960.00 only
EF963-00 90 x 17 mm F 962.00 için iç kutu/Interior box of F 960.00 only



EG

Hemostatik Pensler, Diseksiyon Pensleri, Histerektomi Pensleri
Haemostatic Forceps, Dissecting Forceps, Hyterectomy Forceps





Geçici damar tıkkama için:

Güvenli ve dikkatli şekilde damar kavrama

Sabitlenmiş baskı mesafeli, ırtıklı yüzeyli bleydler

Kapama kuvveti klipsin ağızlarının 1/3 mesafesinde 1 mm aralık durumunda ölçülür.

For temporary occlusion :

Safe and careful gripping of vessel

Blades with serrated surface and rigidly fixed pressure feature

Closing force is measured at 1/3 of the blades a 1 mm opening



BIEMER

ES001-00

Çene uzunluğu/Lenght of jaws 6 mm

Açıklık/Opening 4 mm

Kapanma kuvveti/Closing force 30-40 gr. (0.29 - 0.39 N)

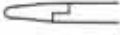

ES002-00

Çene uzunluğu/Lenght of jaws 9 mm

Açıklık/Opening 5 mm

Kapanma kuvveti/Closing force 30-40 gr. (0.29 - 0.39 N)



BIEMER

ES003-00

Çene uzunluğu/Lenght of jaws 9 mm

Açıklık/Opening 5 mm

Kapanma kuvveti/Closing force 20-25 gr. (0.20 - 0.25 N)



for vessel Ø 0.5 - 2.0 mm.

S 034.00 ve S 035.00 ile birlikte kullanılır.

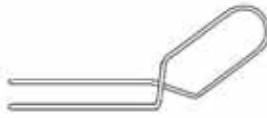

MEHDORN

ES005-00

Çene uzunluğu/Lenght of jaws 1 mm

Açıklık/Opening 4 mm

Kapanma kuvveti/Closing force 10-15 gr. (0.10 - 0.15 N)



MEHDORN

ES005-01

Çene uzunluğu/Lenght of jaws 1.4 mm

Açıklık/Opening 4 mm

Kapanma kuvveti/Closing force 15-20 gr. (0.15 - 0.20 N)



MEHDORN

ES005-05

Çene uzunluğu/Lenght of jaws 1 mm

Açıklık/Opening 6 mm

Kapanma kuvveti/Closing force 10-15 gr. (0.10 - 0.15 N)



MEHDORN

ES005-06

Çene uzunluğu/Lenght of jaws 1.4 mm

Açıklık/Opening 6 mm

Kapanma kuvveti/Closing force 15-20 gr. (0.15 - 0.20 N)



for vessel Ø 0.5 - 2.0 mm.

S 032.00 ile birlikte kullanılır.

Mikro damar anastomileri için:

Güvenli ve dikkatli şekilde damar kavrama.

Sabitlenmiş baskı mesafeli, tırtıllı yüzeyli bleydler.

Klipsler arası mesafe ayarlanabilir.

Bükerek otomatik sabitleme.

For micro vessel anastomosis:

Safe and careful gripping of vessel.

Blades with serrated surface and rigidly fixed pressure feature.

Adjustable distance between clips.

Automatic fixation by tilting.



BIEMER-MÜLLER

ES010-00

Çene uzunluğu/Lenght of jaws.6 mm

Açıklık/Opening 4 mm

Kapanma kuvveti/Closing force 30-40 gr.



BIEMER-MÜLLER

ES011-00

Çene uzunluğu/Lenght of jaws.4.5 mm

Açıklık/Opening 3 mm

Kapanma kuvveti/Closing force 25-30 gr.

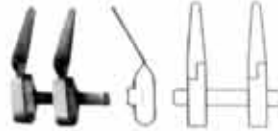

BIEMER-MÜLLER

ES012-00

Çene uzunluğu/Lenght of jaws.9 mm

Açıklık/Opening 5 mm

Kapanma kuvveti/Closing force 25-30 gr.



BIEMER-MÜLLER

ES013-00

Çene uzunluğu/Lenght of jaws.9 mm

Açıklık/Opening 5 mm

Kapanma kuvveti/Closing force 25-30 gr.



BIEMER-MÜLLER

ES014-00

Çene uzunluğu/Lenght of jaws.9 mm

Açıklık/Opening 5 mm

Kapanma kuvveti/Closing force 25-30 gr.



BIEMER-MÜLLER

ES015-00

Çene uzunluğu/Lenght of jaws.9 mm

Açıklık/Opening 5 mm

Kapanma kuvveti/Closing force 25-30 gr.

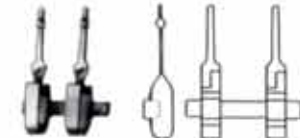

MÜLLER

ES020-00

Kapanma kuvveti/Closing force. 25-30 gr.

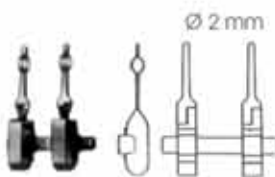

MÜLLER

ES021-00

Kapanma kuvveti/Closing force. 25-30 gr.

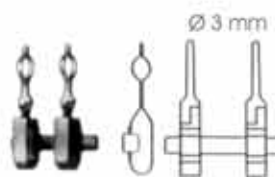

MÜLLER

ES022-00

Kapanma kuvveti/Closing force. 25-30 gr.

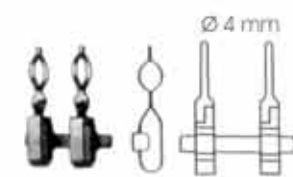

MÜLLER

ES023-00

Kapanma kuvveti/Closing force. 25-30 gr.





BIEMER
ES035-00
Kilitli/Without lock

BIEMER
ES034-00
Kilitli/With lock

BIEMER
ES024-00
Uygulama pensetleri, damar klipsleri,
BIEMER-MÜLLER ve MÜLLER aproksi-
matör.
Applying forceps for BIEMER
vessel approximator
14,5 cm

MEHDORN
ES032-00
Uygulama pensetleri, MEHDORN
damar klipsleri
Applying forceps for MEHDORN
vessel clips
15 cm

BIEMER
ES034-00-ES035-00
BIEMER damar klipsleri ve BIEMER-MÜLLER ve
MÜLLER yaklaştıncılar için başvuru pensleri
Applying forceps for BIEMER vessel clips and
BIEMER-MÜLLER and MÜLLER approximators
14 cm



BIEMER
ES025-00
Komple Aproksimatör,
anahtar ile S 029.00 Approximator, complete
with key S 029.00

Derin aralıkta mikro damar anastomileri için.

- Güvenli ve dikkatli şekilde damar kavrama.
- Tırtıklı yüzeyli bleydler.
- Anahtar ile (S 029.00) basınç ayarı.
- Anahtar ile (S 029.00) klipsler arası mesafenin ayarlanması ve sabitlenmesi.

For micro vessel anastomosis

- Safe and careful gripping of vessel.
- Blades with serrated blade surface
- Pressure adjustment with use of key(S 029.00)
- Adjustment of distance between blades and fixation of blades with a use of key(S 029.00)



BIEMER
ES026-00
Komple Aproksimatör,
anahtar ile S 029.00
Approximator, complete
with key S 029.00

Sinir anastomilerine güvenli adaptasyon

- Sinir merkezinin, güçlü patolojik değişiklikleri önleyen hassas iğneler ile delinmesi
- Anahtar(S 029.00) kullanımı ile değiştirilebilir iğneler.
- Anahtar ile iğneler arası mesafenin ayarlanması ve sabitlenmesi

Safe adaptation of nerve anastomoses

- Piercing the nerve center with fine needles that prevents strong pathological changes
- Changeable needles with use of key.(S 029.00)
- Adjustment of distance between needles and fixation of needles with use of key(S 029.00)



ES030-00
Approximator

Derin aralıkta mikro damar anastomileri için.

- Güvenli ve dikkatli şekilde damar kavrama.
- Tırtıklı yüzeyli bleydler.
- El ile basınç ayarı yapabilmek özelliği.
- Mesafeyi el ile yakınlaştırma ve uzaklaştırma.

For micro vessel anastomosis

- Safe and careful gripping of vessel.
- Blades with serrated blade surface
- The ability to manually set the pressure
- Distance, zoom in and out manually.





Travmatik olmayan damar klipleri, Geçici Non-traumatic Vessel Clips, temporary



MÜLLER
EG015-00
Kapama kuvveti 50 gr/Düz
Closing Forceps 50 gr/Straight
EG016-00
Kapama kuvveti 80 gr/Düz
Closing forceps 80 gr/Straight



MÜLLER
EG015-05
Kapama kuvveti 50 gr/Eğil
Closing forceps 50 gr/Curved
EG016-05
Kapama kuvveti 80 gr/Eğil
Closing forceps 80 gr/Curved



MÜLLER
EG015-10
Kapama kuvveti 50 gr/Eğil
Closing forceps 50 gr/Curved
EG016-10
Kapama kuvveti 80 gr/Eğil
Closing forceps 80 gr/Curved



MÜLLER
EG015-15
Kapama kuvveti 50 gr/Yana doğru açılı
Closing forceps 50 gr/Angled to side
EG016-15
Kapama kuvveti 80 gr/Yana doğru açılı
Closing forceps 80 gr/Angled to side



MÜLLER
EG015-20
Kapama kuvveti 50 gr/Diz bükümlü
Closing Forceps 50 gr/Knee-bent
EG016-20
Kapama kuvveti 80 gr/Diz bükümlü
Closing Forceps 80 gr/Knee-bent

Özellikler :

- Atraumatik ağız profili.
- Her iki tarafa kullanılan tutma plakaları kliplerin güvenli bir şekilde uygulanması ve çıkarılmasına yardımcı olur.
- Arter ve toplar damarlar için kesin olarak tanımlanmış kapama basınçları.
- Damar klemplerinin üzerine kapanma basınçları markalanmıştır.

Features :

- Atraumatic mouth profile.
- Holding plates used on both side of the clips ensure safe application and removal.
- Closing pressure of the clips are exactly defined for arterial and venous vessels.
- Closing pressure of the clips is marked on the clips.

De Bakay Dış



Toothing De Bakay



1/2

MÜLLER

EH113-00

Kapama kuvveti/Closing force 250 gr

EH113-01

Kapama kuvveti/Closing force 350 gr

Düz/Straight



1/2

MÜLLER

EH114-00

Kapama kuvveti/Closing force 250 gr

EH114-01

Kapama Kuvveti/Closing force 350 gr

Eğil/Curved



1/2

MÜLLER

EH115-00

Kapama kuvveti/Closing force 250 gr

EH115-01

Kapama kuvveti/Closing force 350 gr

Eğil/Curved



1/2

MÜLLER

EH116-00

Kapama kuvveti/Closing force 250 gr

EH116-01

Kapama Kuvveti/Closing Force 350 gr

Diz bükümlü/Knee-bent





V1

Toplam boy
Total length

Ağız uzunluğu
Length of jaws

DIEFFENBACH

EG020-00 38 mm 12 mm
EG020-01 48 mm 16 mm



V1

Toplam boy
Total length

Ağız uzunluğu
Length of jaws

DIEFFENBACH

EG021-00 38 mm 12 mm
EG021-01 48 mm 16 mm



V1

Toplam boy
Total length

Ağız uzunluğu
Length of jaws

DIEFFENBACH

EG022-00 58 mm 16 mm



V1

Toplam boy
Total length

Ağız uzunluğu
Length of jaws

DIEFFENBACH

EG023-00 58 mm 16 mm



Toplam boy
Total length

Ağız uzunluğu
Length of jaws

DE BAKEY-HESS

EG030-00 5 mm 20mm
EG030-01 5,7 mm 30mm



Toplam boy
Total length

Ağız uzunluğu
Length of jaws

JOHNS-HOPKINS

EG024-00 38 mm 12 mm
EG024-01 48 mm 17 mm
EG024-02 56 mm 25 mm
EG024-03 63 mm 30 mm
EG024-04 70 mm 33 mm
EG024-05 80 mm 42 mm
EG024-06 91 mm 52 mm



1/2

JOHNS-HOPKINS

EG026-00

Buldog klemplerin takılması ve çıkarılması için pens

EG020-00-EG030-01 ve

EH120-00-EH121-03

Forceps for applying and removing bulldog clamps

EG020-00-EG030-01 and **EH120-00-EH121-03**
24 cm

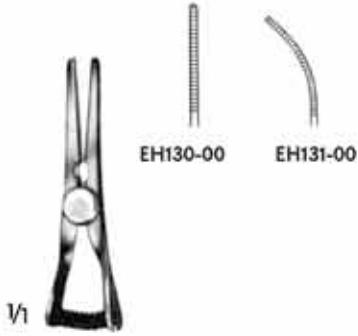

EH130-00-EH131-00
Ağız uzunluğu 14 mm
Length of jaws 14 mm
35 m



EH130-01
Ağız uzunluğu 19 mm
Length of jaws 19 mm
45 mm



EH131-01
Ağız uzunluğu 19 mm
Length of jaws 19 mm
45 mm



DIETRICH
EG010-01
Ağız uzunluğu 13 mm
Length of jaws 13 mm
55 mm



DIETRICH
EG011-03
Ağız uzunluğu 10 mm
Length of jaws 10 mm
48 mm



DIETRICH
EG011-06
Ağız uzunluğu 13 mm
Length of jaws 13 mm
48 mm





De Bakey Diş



Toothing De Bakey

Kapanma kuvveti 180 gr.
Closing force 180 gr.



V1

EH105-00

Ağız uzunluğu 10 mm
Length of jaws 10 mm
Düz/Straight
5 cm



V1

EH105-02

Ağız uzunluğu 14 mm
Length of jaws 14 mm
Düz/Straight
5.5 cm



V1

EH105-04

Ağız uzunluğu 20 mm
Length of jaws 20 mm
Düz/Straight
6 cm



V1

EH106-00

Ağız uzunluğu 20 mm
Length of jaws 20 mm
Eğri/Curved
5.5 cm



55°

V1

EH107-00

Ağız uzunluğu 10 mm
Length of jaws 10 mm
Açılı/Angled
5 cm



55°

V1

EH107-01

Ağız uzunluğu 14 mm
Length of jaws 14 mm
Açılı/Angled
5 cm



55°

V1

EH107-02

Ağız uzunluğu 20 mm
Length of jaws 20 mm
Açılı/Angled
5.5 cm

De Bakey Diş



Toothing De BAkey



DE BAKEY
EH137-00
Ağız uzunluğu 27 mm
Length of jaws 27 mm
4,8 cm



DE BAKEY
EH138-01
Ağız uzunluğu 38 mm
Length of jaws 38 mm
7,3 cm



DE BAKEY
EH139-00
Ağız uzunluğu 42 mm
Length of jaws 42 mm
10 cm



DE BAKEY
EH140-00
Ağız uzunluğu 54 mm
Length of jaws 54 mm
9,5 cm



DE BAKEY
EH136-00
Ağız uzunluğu 27 mm
Length of jaws 27 mm
5 cm



GLOVER
EH134-00
Ağız uzunluğu 20 mm
Length of jaws 20 mm
5,2 cm



	Toplam boy Total length	Ağız uzunluğu Length of jaws
GLOVER EH136-01	6,8 cm	33 mm
EH136-02	9,6 cm	50 mm
EH136-03	11,7 cm	69 mm



	Toplam boy Total length	Ağız uzunluğu Length of jaws
GLOVER EH137-01	6,5 cm	25 mm
EH137-02	9,1 cm	50 mm
EH137-03	11 cm	69 mm



	Toplam boy Total length	Ağız uzunluğu Length of jaws
DE BAKEY EH120-00	8,0 cm	25 mm
EH120-01	9,0 cm	35 mm
EH120-02	10,5 cm	50 mm
EH120-03	12,4 cm	68 mm



	Toplam boy Total length	Ağız uzunluğu Length of jaws
DE BAKEY EH121-00	7,8 cm	23 mm
EH121-01	8,6 cm	31 mm
EH121-02	9,7 cm	42 mm
EH121-03	11,4 cm	58 mm



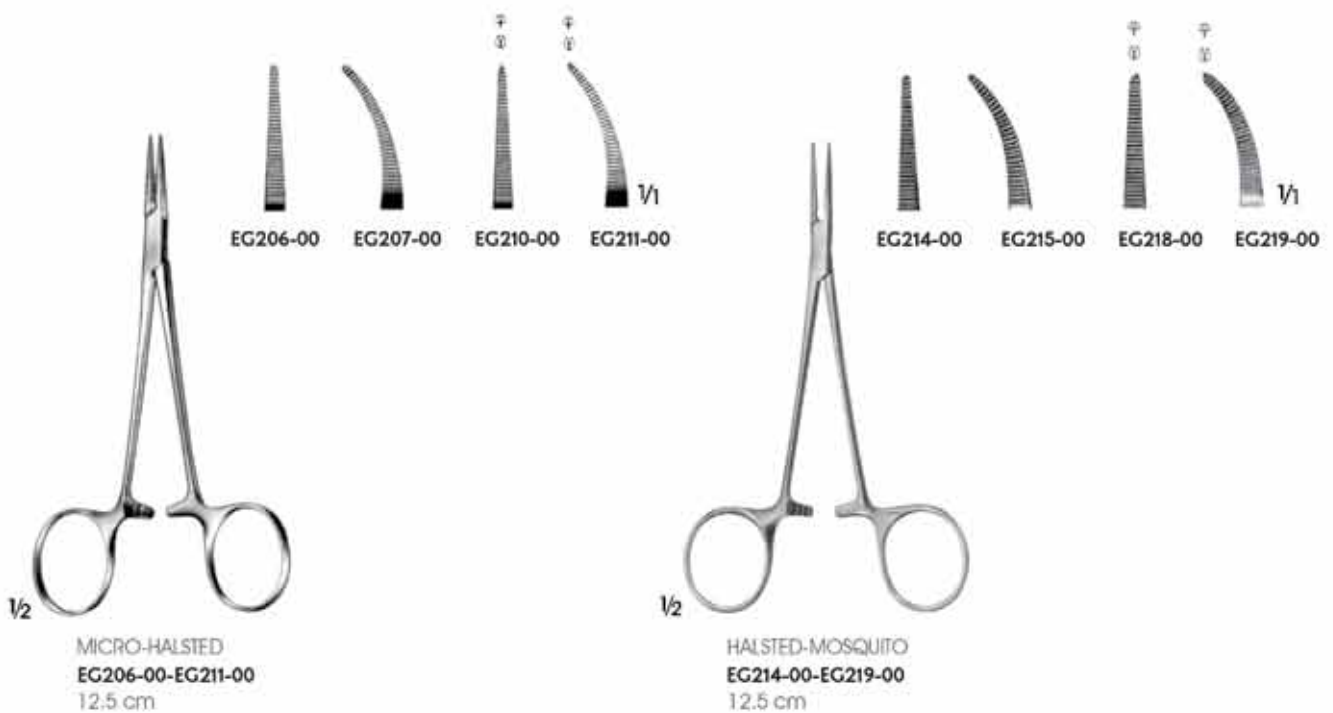
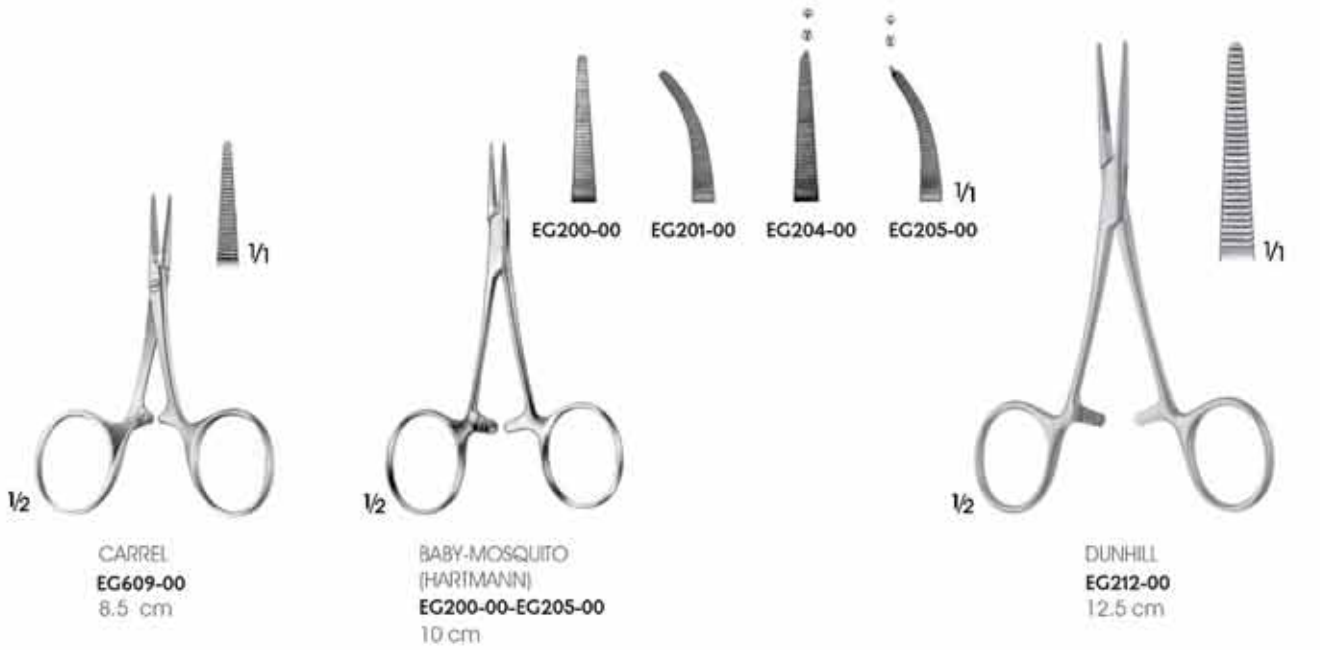



BABY-CRILE
EG220-00-EG227-00
14 cm

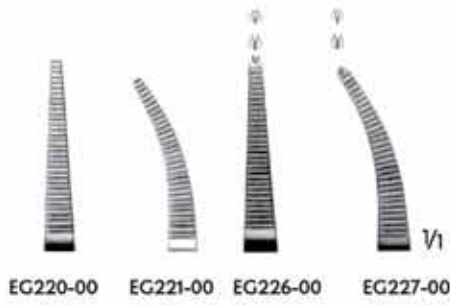

CAIRNS
EG228-00-EG229-00
15 cm

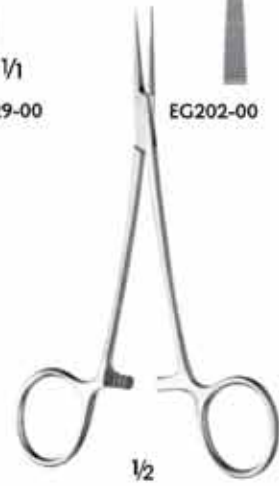

JACOBSON
EG202-00-EG203-00
12.5 cm

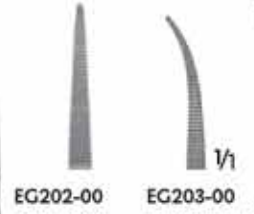

PROVIDENCE-HOSPITAL
EG230-00-EG231-00
14 cm



KELLY
EG234-00-EG235-00
14 cm

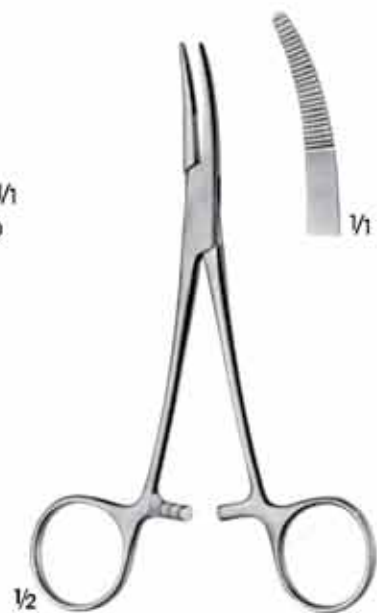

MOYNIHAN
EG233-00
Yana eğimli/Curved to side
15 cm





CAIRNS
EG237-00
Yana eğimli/Curved to side
14.5 cm



DANDY
EG238-00-EG239-00
Yana eğimli/Curved to side
14 cm



CRILE
EG240-00-EG245-00
14 cm

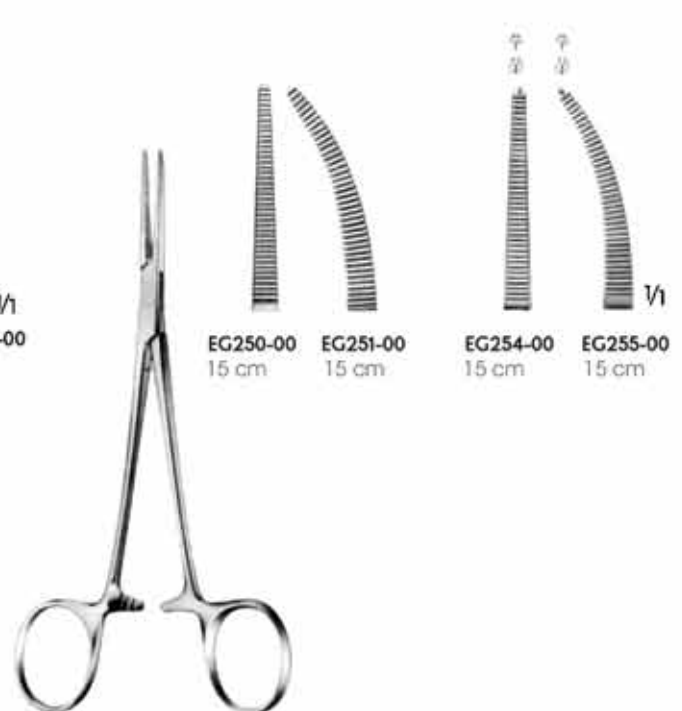

LERICHE
EG250-00-EG255-00





DIXON-LOVELACE
EG270-00-EG271-00
16 cm



FUCHSIG
EG274-00
19.5 cm

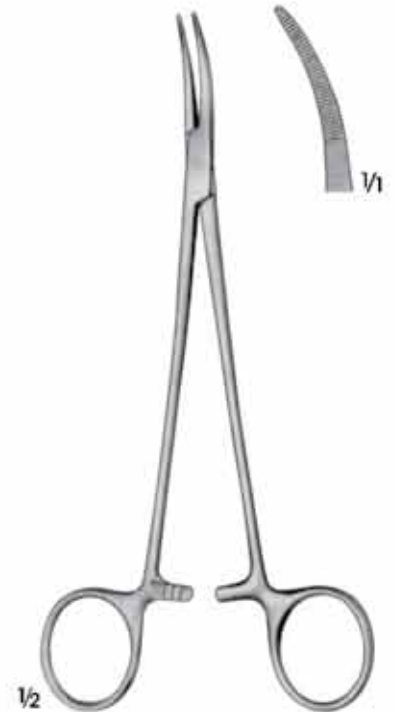

NISSEN
EG275-00
18.5 cm



ADSON
EG278-00-EG279-00
18.5 cm

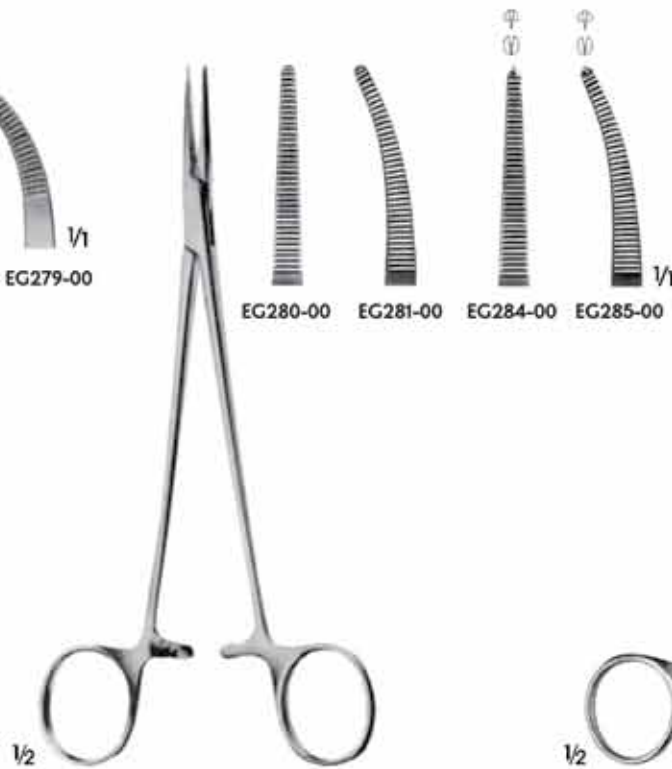

HALSTED
EG280-00-EG285-00
18.5 cm

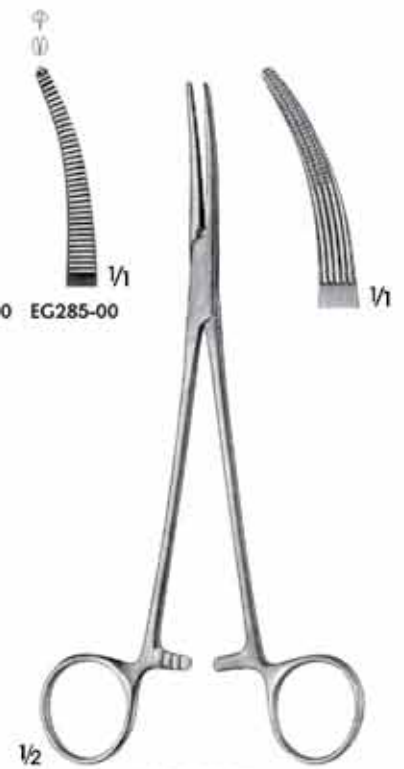

GREY-TURNER
EG286-00
18 cm



BIRKETT
EG288-00-EG289-00
18,5 cm

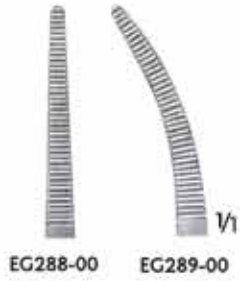

HALSTED-MOSQUITUO
EG290-00-EG295-00
20 cm

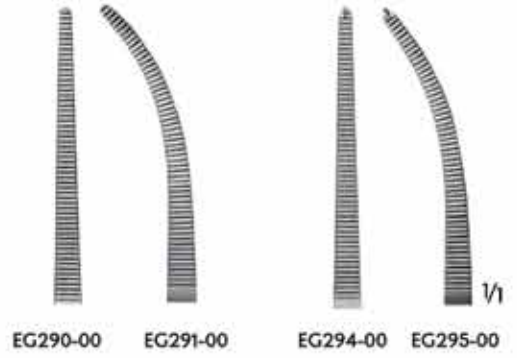

FRASER-KELLY (CRILE)
EG276-00
18 cm



DUNHILL
EG277-00
19 cm



JACOBSON
EG273-00
19 cm



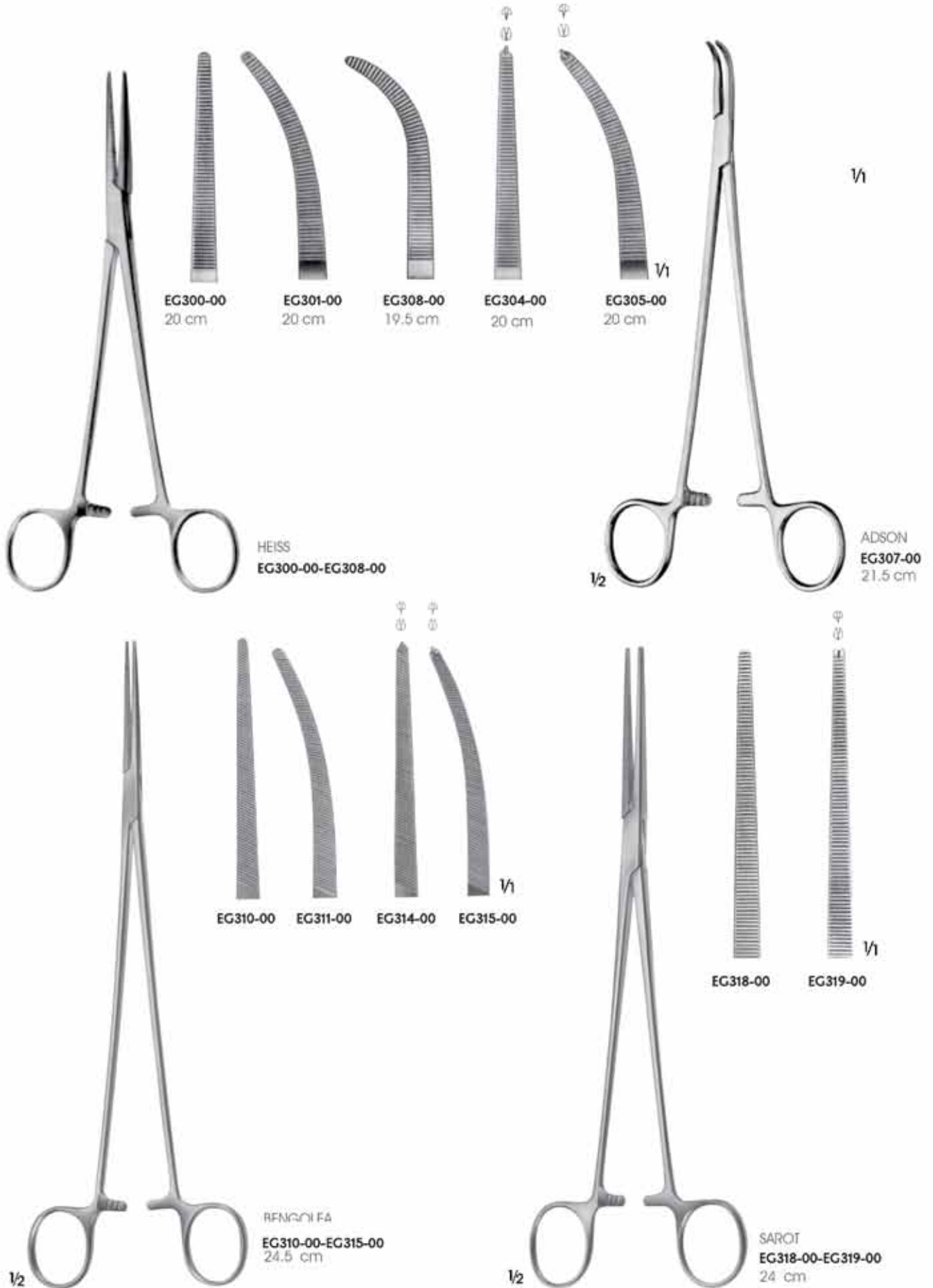



PEAN
EG400-00
12.5 cm



KRÖNLEIN
EG401-00
13 cm



PEAN
EG402-00
12.5 cm



PEAN
EG404-00-EG404-01



EG404-00
12.5 cm



EG404-01
14 cm



PEAN
EG408-00-EG408-01



EG408-00
16.5 cm



EG408-01
18.5 cm



PEAN
EG420-00-EG421-01
Ince model/Slender type

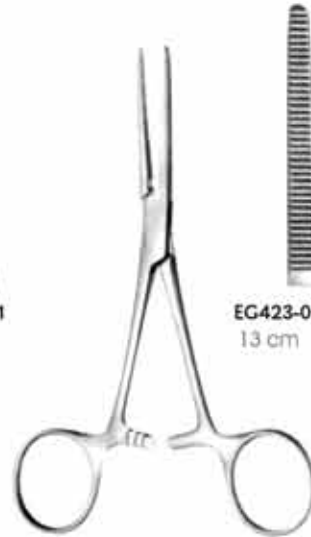
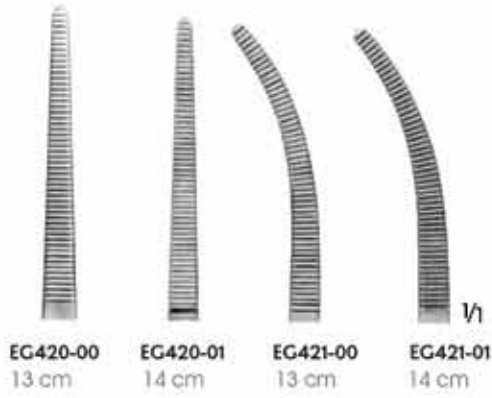

PEAN
EG423-00-EG424-00

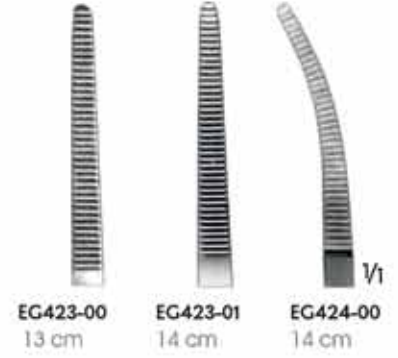

SPENCER - WELLS
EG427-00-EG428-04

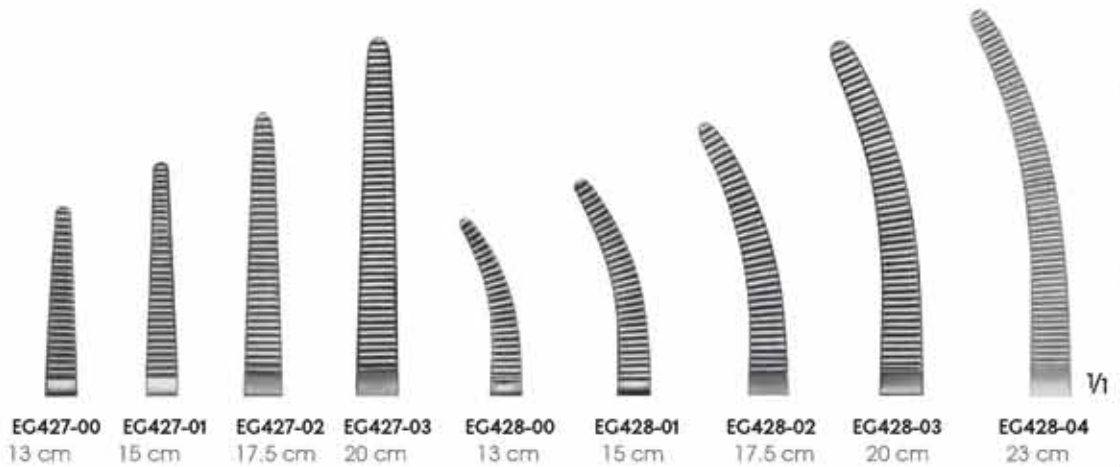

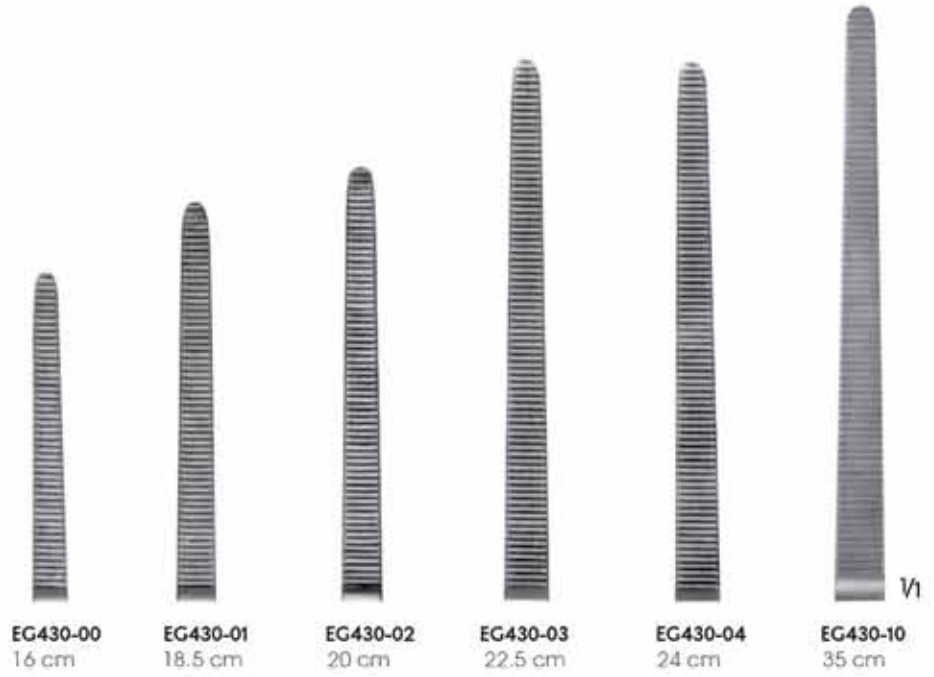

ROCHESTER - PEAN
EG430-00-EG431-10



PEAN
EG434-00-EG435-02

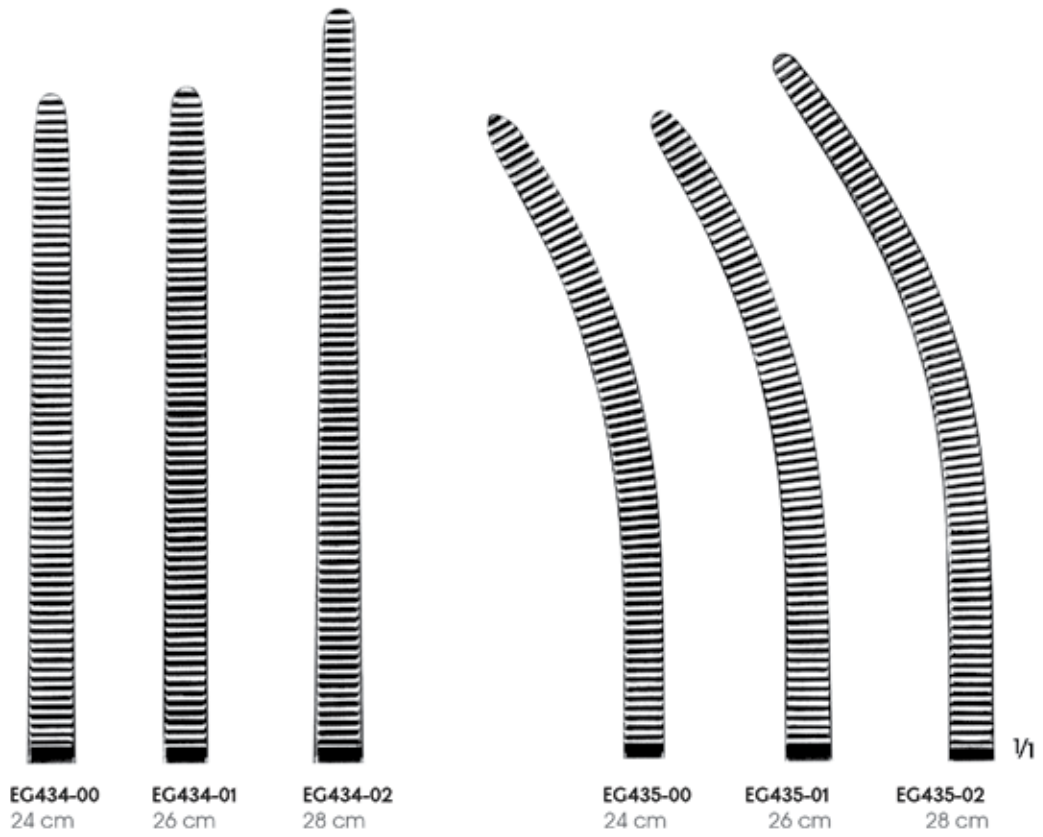



KOCHER
EG437-00
Güçlü model/Strong pattern
14.5 cm

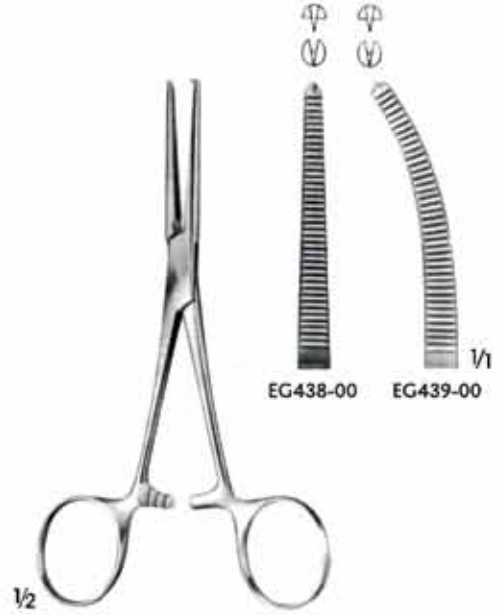

ROCHESTER-OCHSNER
EG438-00-EG439-00
14 cm

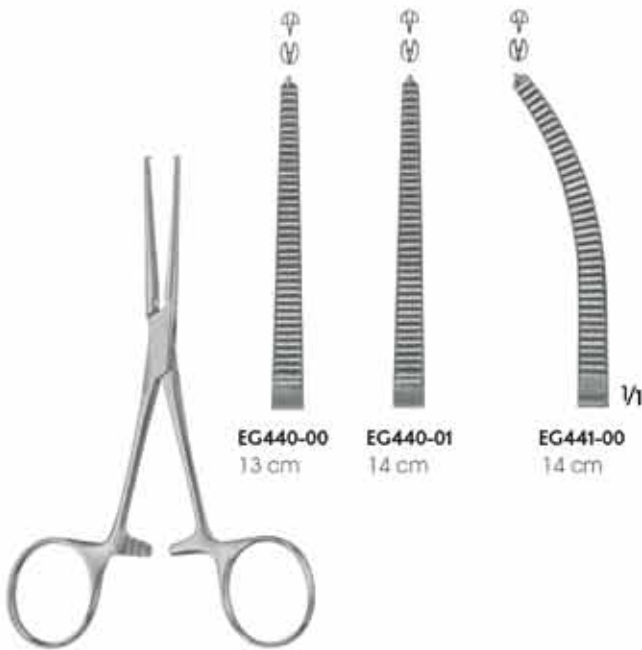

KOCHER
EG440-00-EG441-00

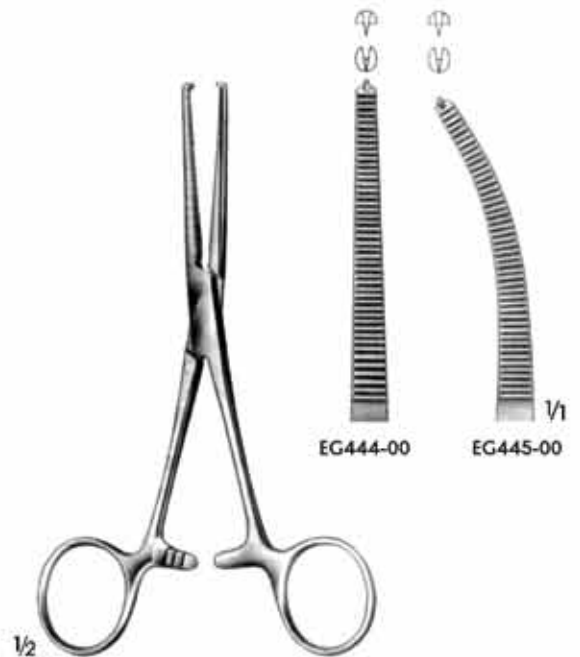

KOCHER
EG444-00-EG445-00
15 cm

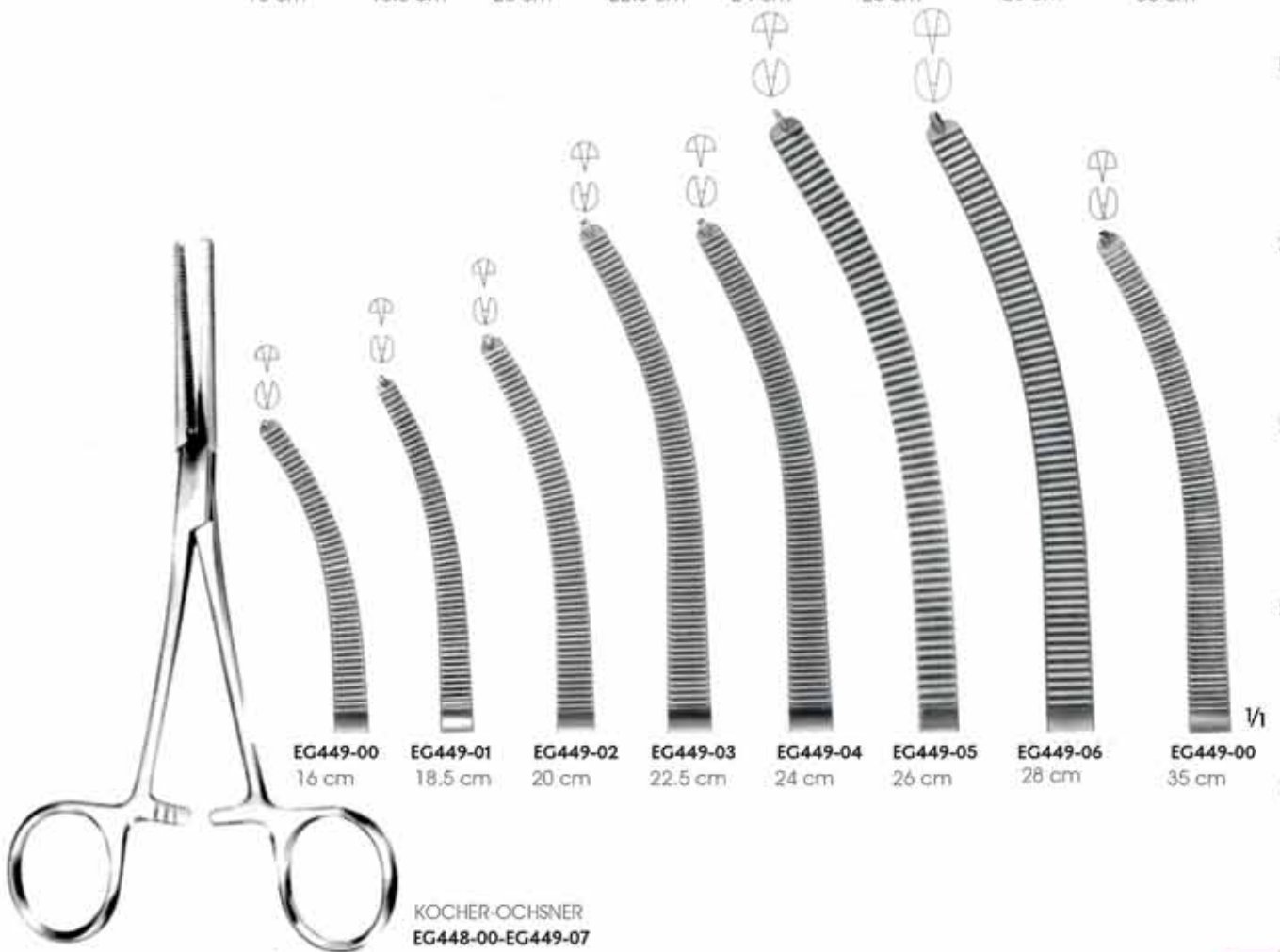
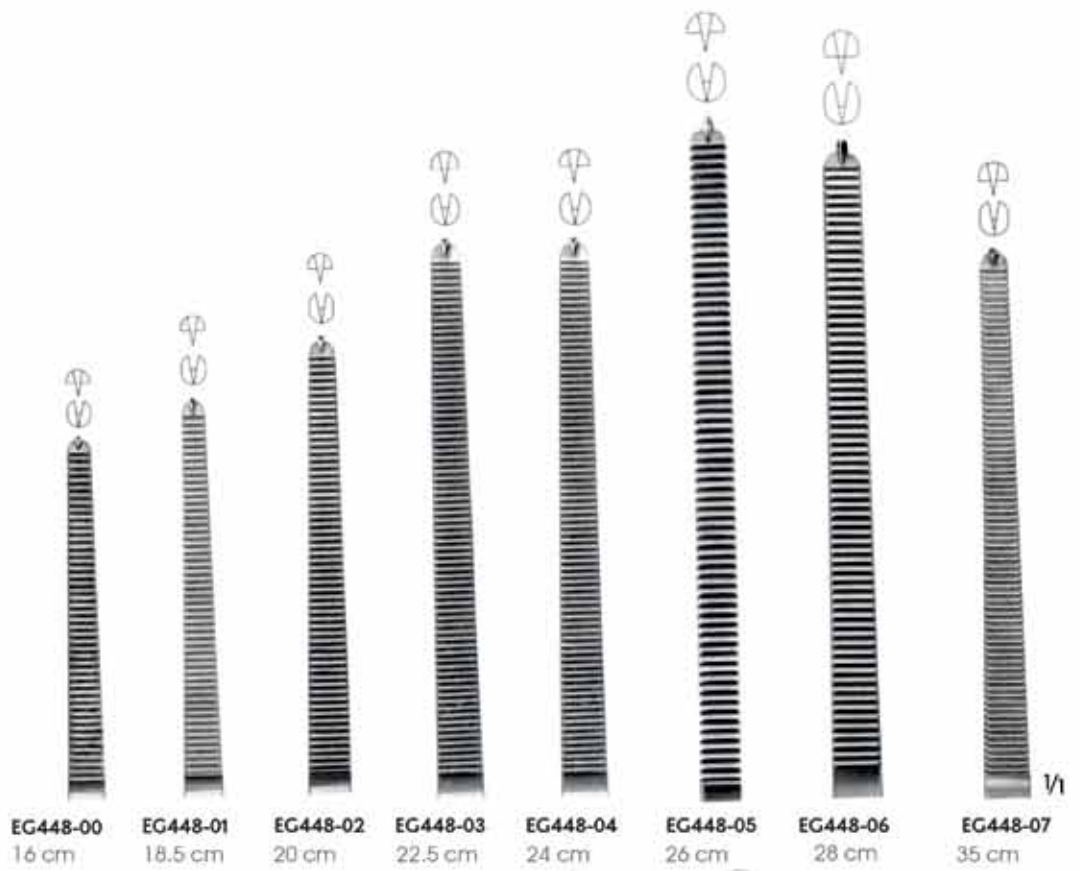

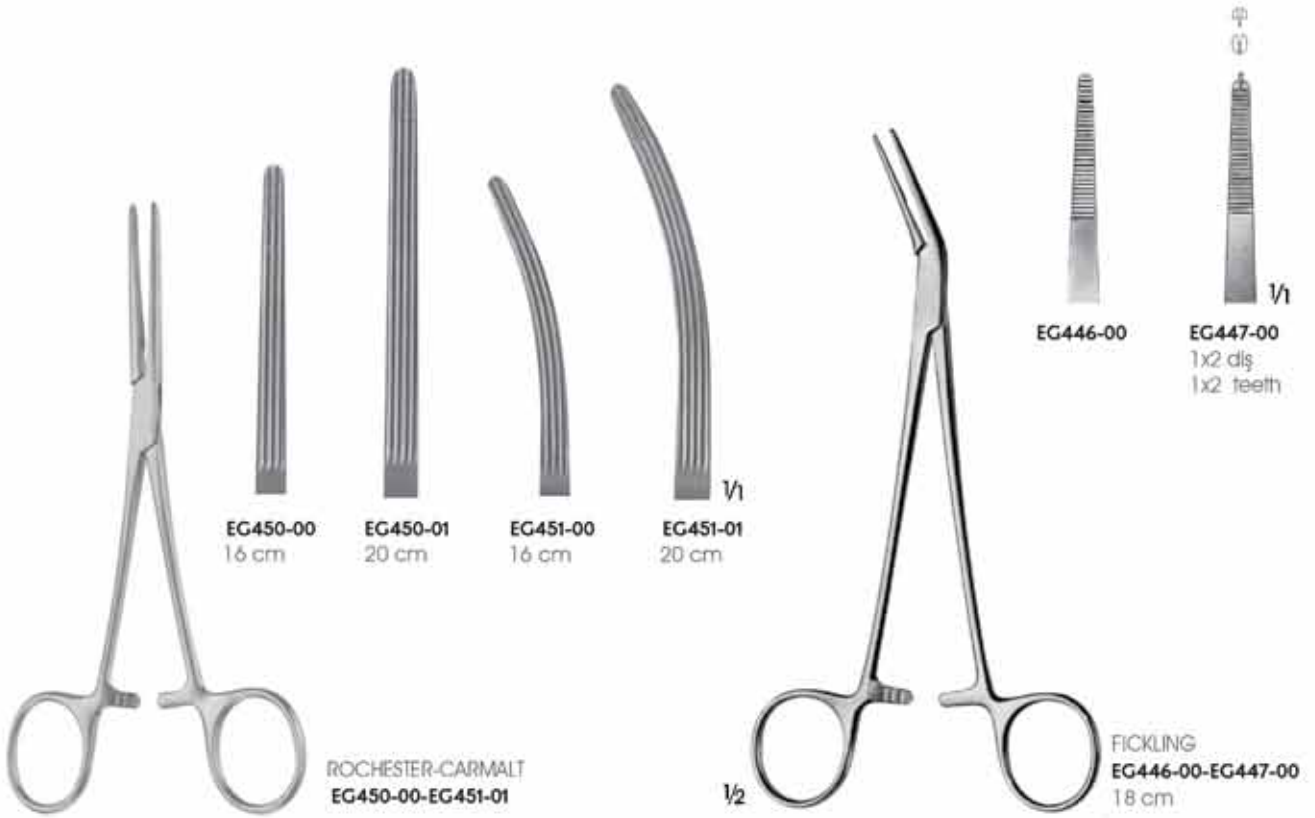



EG459-00
19.5 cm



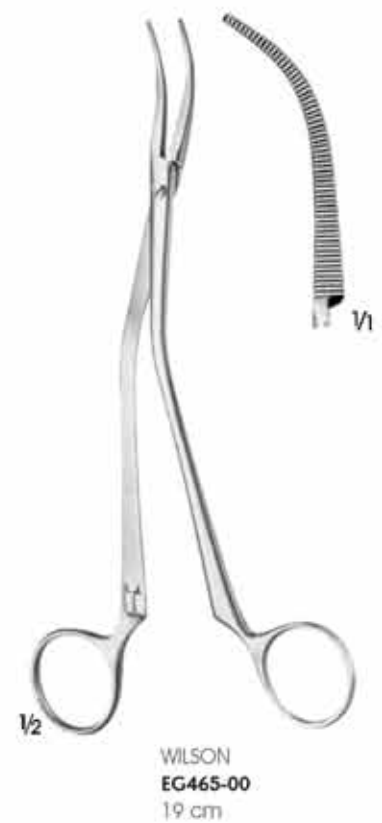
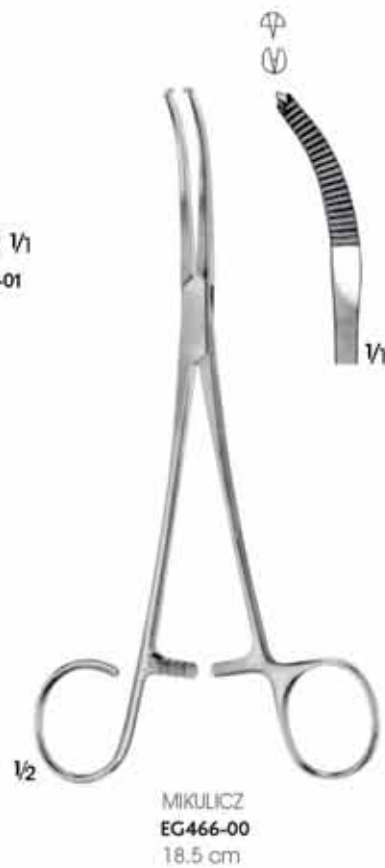
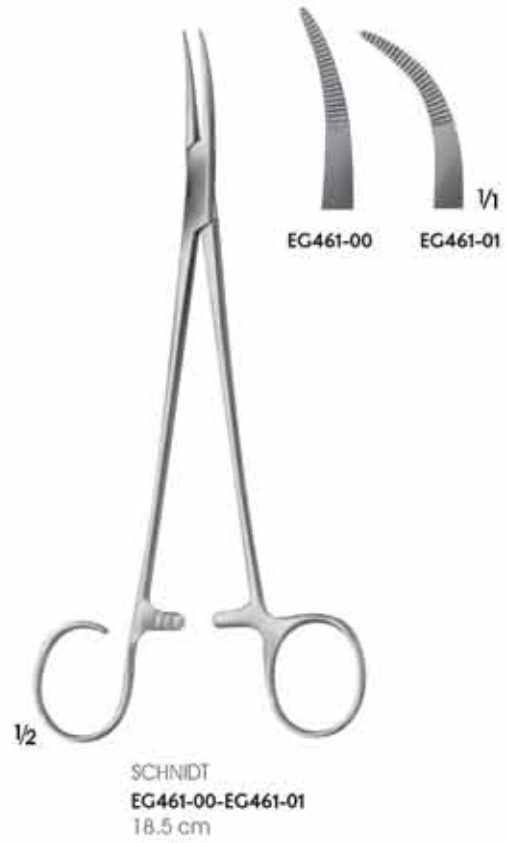

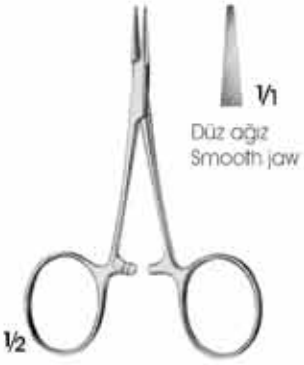

EG610-00
Ligatür pensli, düz
Ligature forcecp, straight
9.5 cm



EG614-00
MICRO-ADSON
Diseksiyon pensli
Dissecting forcecp
14 cm



EG615-00
BABY-OVERHOLT
Diseksiyon pensli
Dissecting forcecp
13.5 cm



BABY-MIXTER
EG616-00-EG616-01
Diseksiyon pensleri
Dissecting forcecps



BABY-ADSON
EG617-00-EG617-01
Diseksiyon pensleri
Dissecting forcecps



EG621-00-EG621-01
Diseksiyon pensleri
Dissecting forcecps



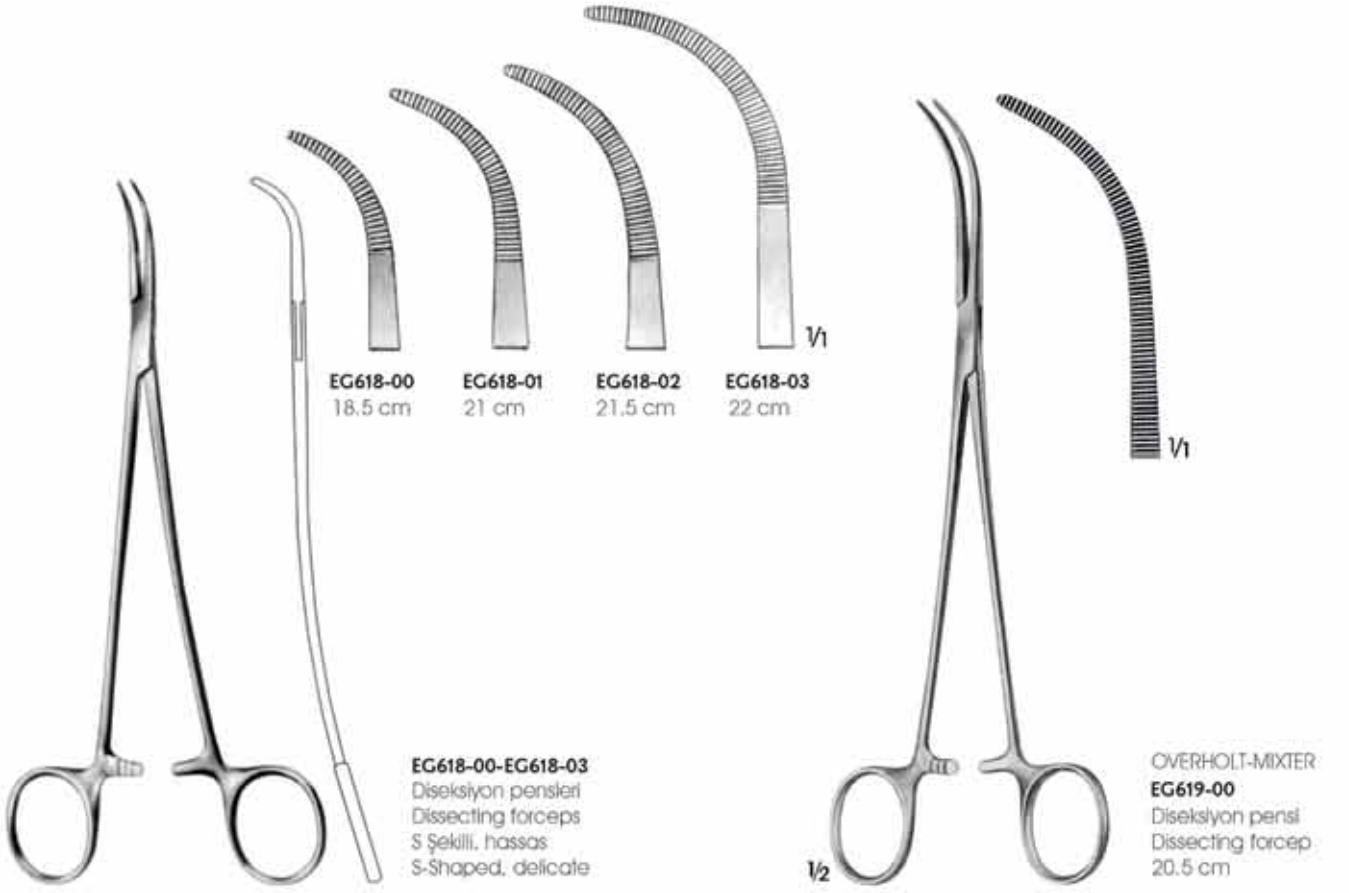

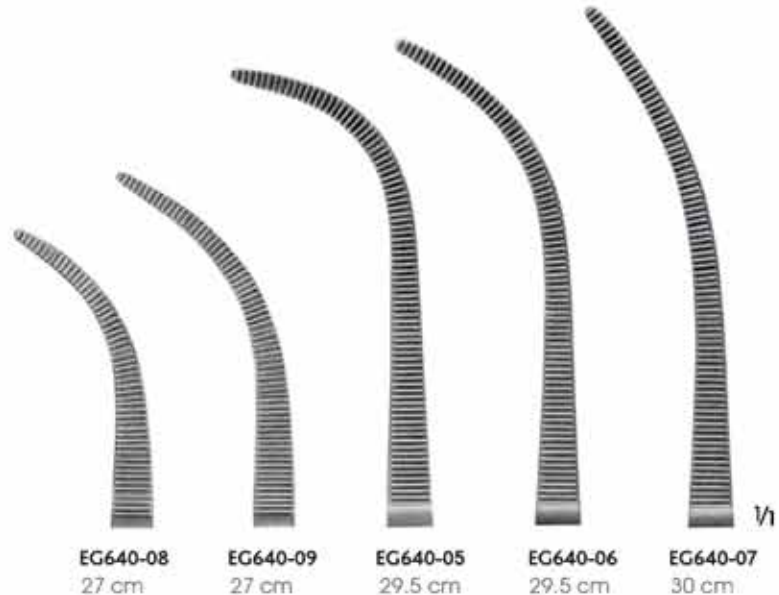
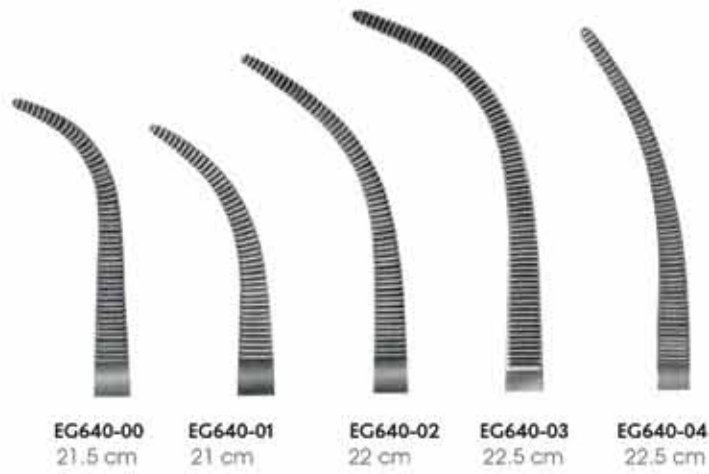

OVERHOLT
EG640-00-EG640-07
Hassas model/Delicate pattern

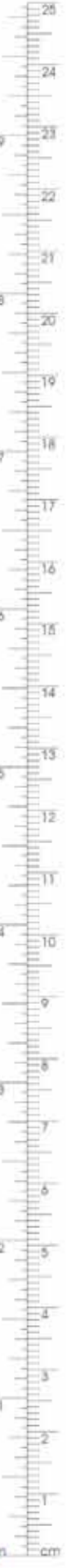



OVERHOLT-GEISSENDOERFER
EG641-00-EG641-04

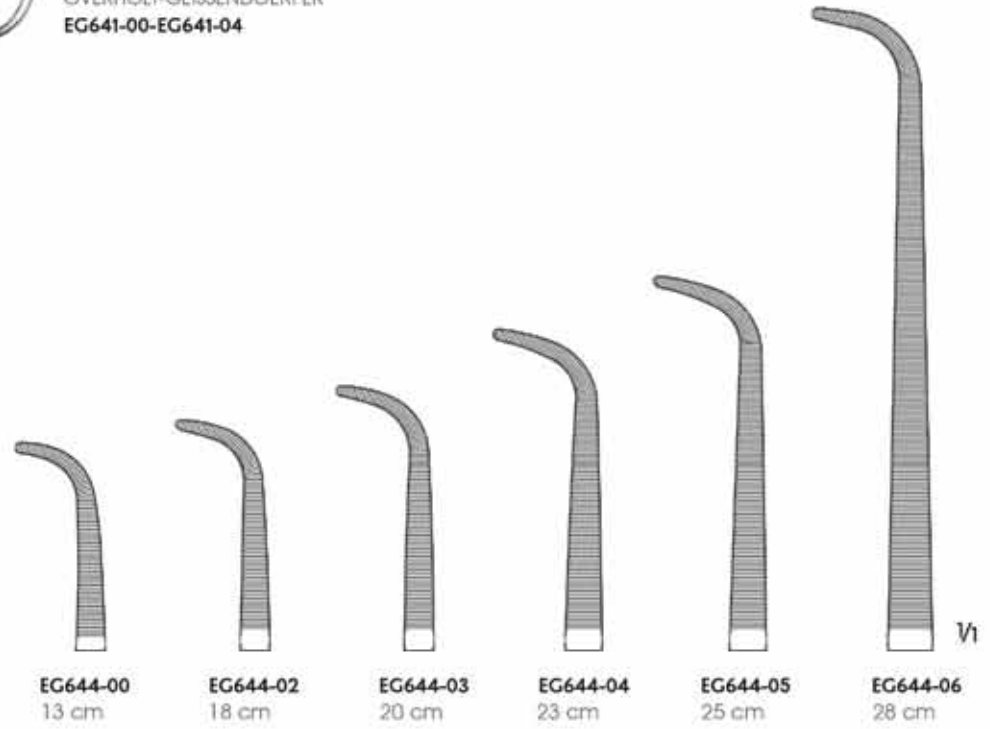

GEMINI
EG644-00-EG644-06



EG652-00
15 cm



EG652-01
18 cm



EG652-02
20 cm



EG652-04
23 cm



EG652-05
25.5 cm

O'SHAUGHNESSY
EG652-00-EG652-05



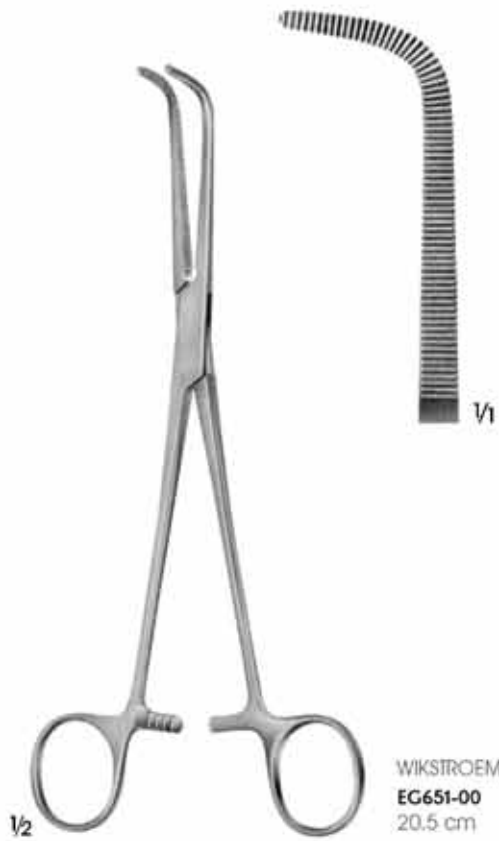
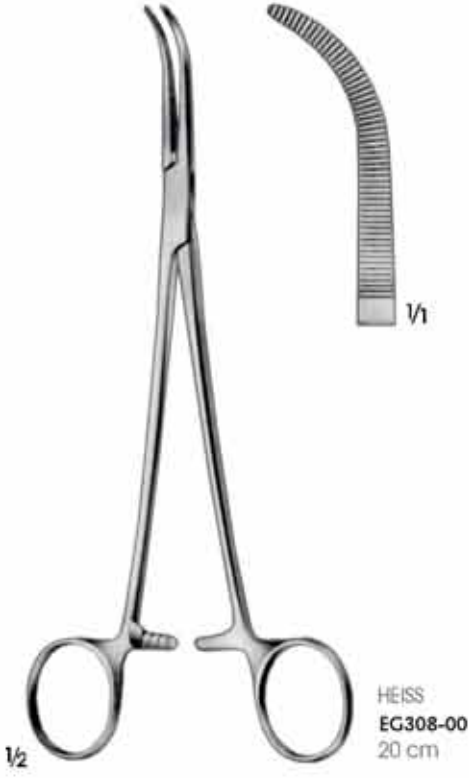



EG656-00
20 cm

EG656-01
24 cm

EG656-02
27.5 cm

KANTROWITZ
EG656-00-EG656-02



EG657-00
Çok hassas
Extra delicate

EG657-05
Hassas
Delicate

BARRE
EG657-00-EG657-05
28 cm



EG658-00

EG658-01

EG658-02

EG658-03

EG658-04

RUMEL
EG658-00-EG658-04
24 cm





ZENKER
EG669-00-EG669-07



EG669-00
30 cm



EG669-01
29 cm



EG669-04
35 cm



EG669-05
35 cm



EG669-07
35 cm

1/1



MIXTER
EG654-00
23 cm



LAWRENCE
EG664-00
27 cm



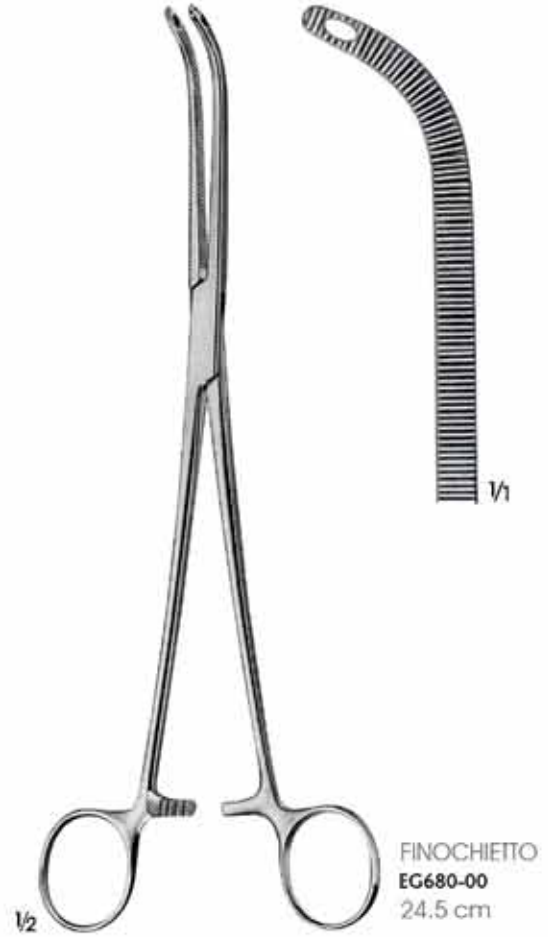
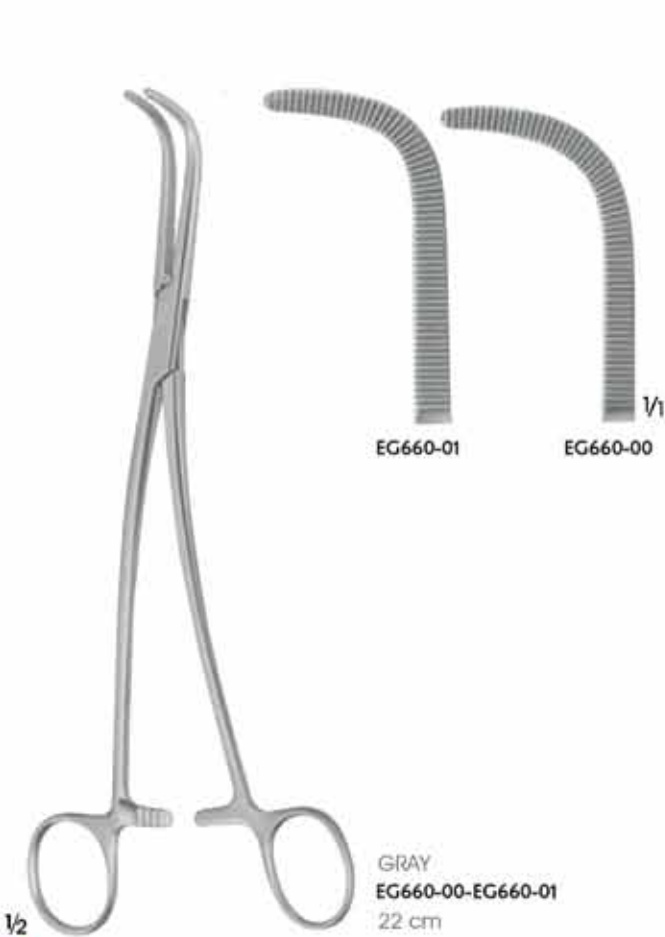
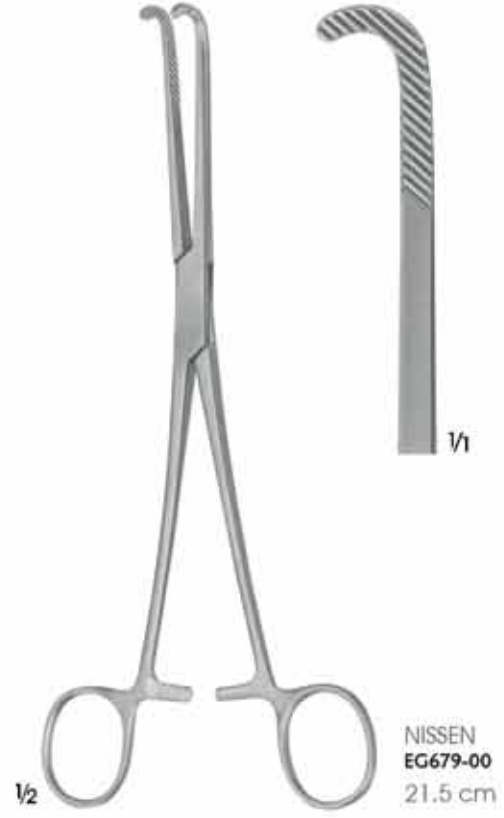
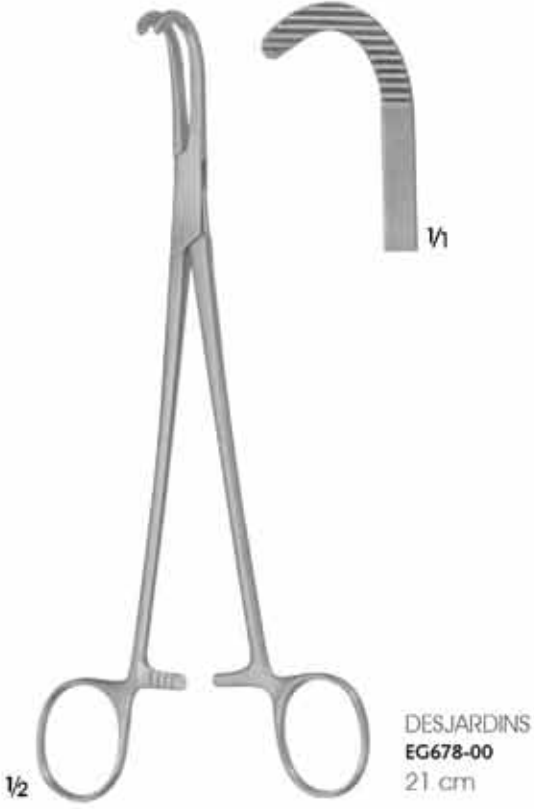

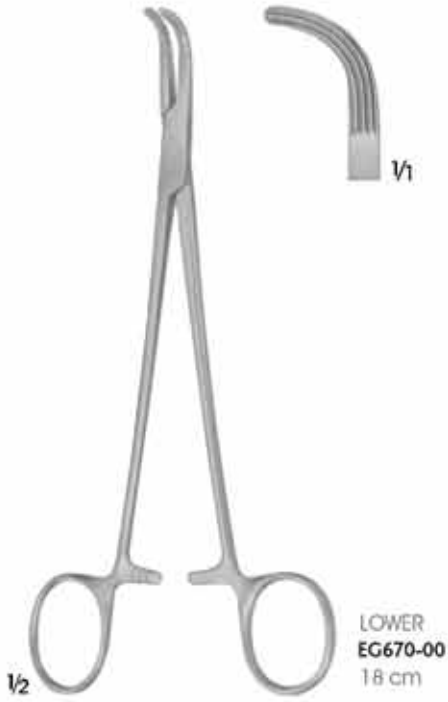

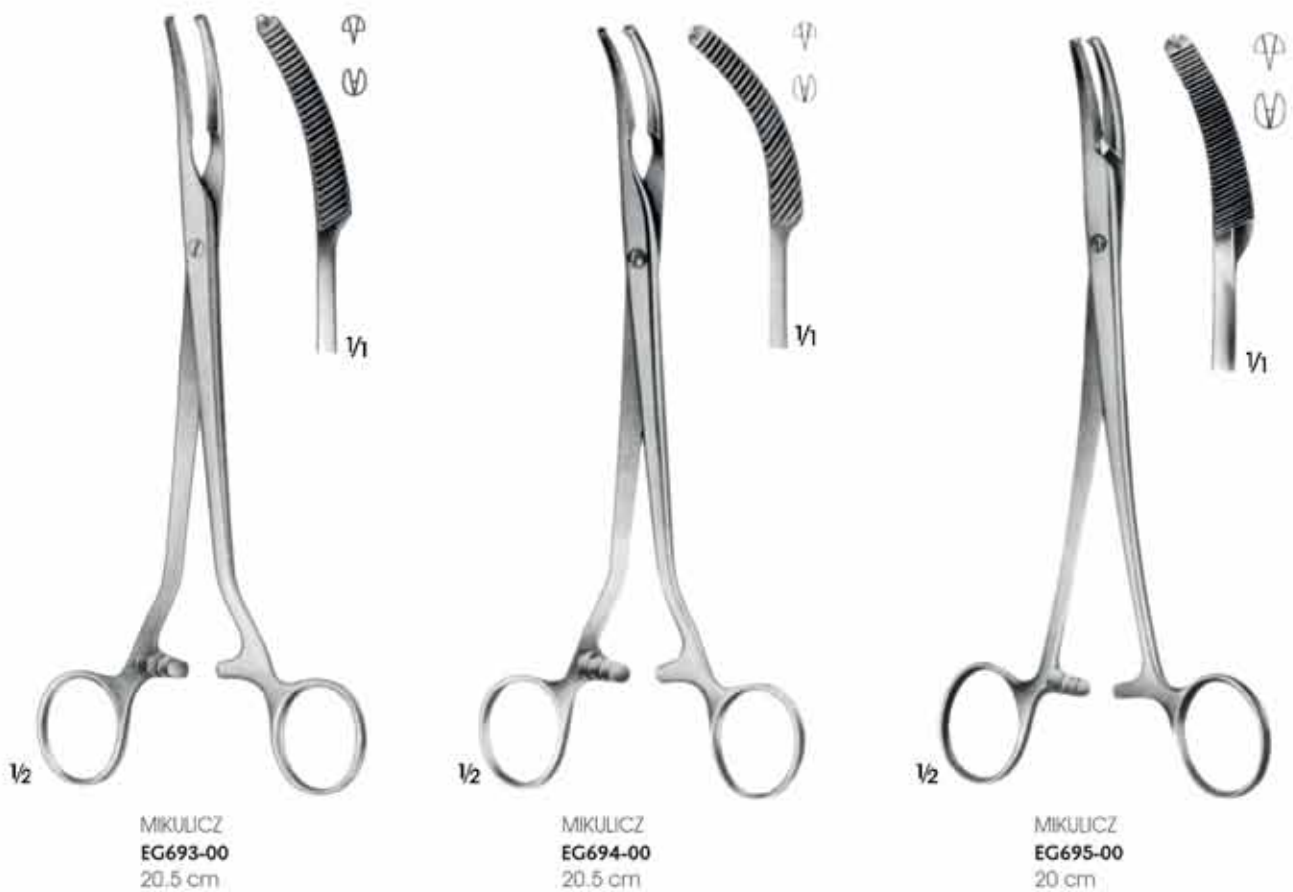
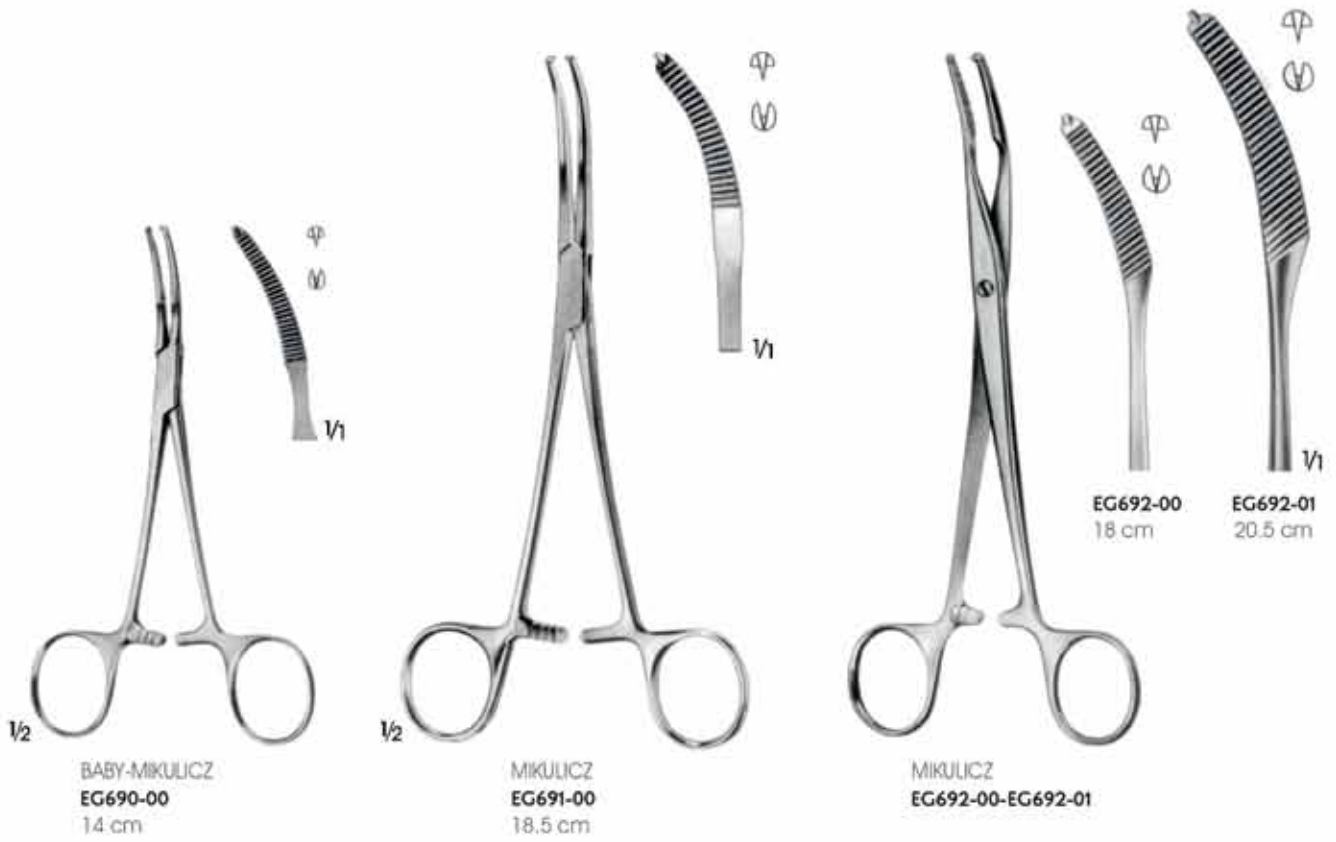

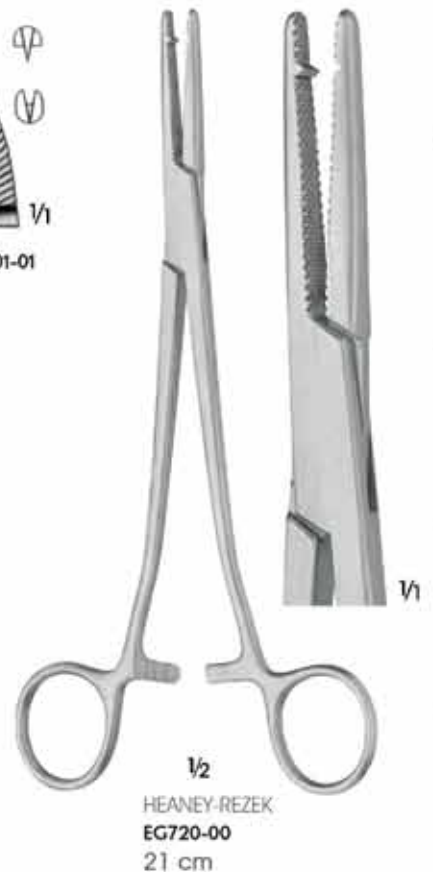
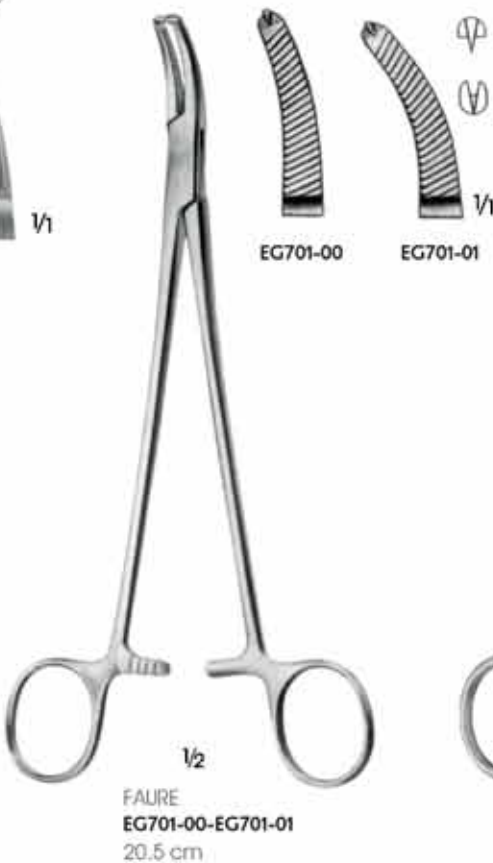

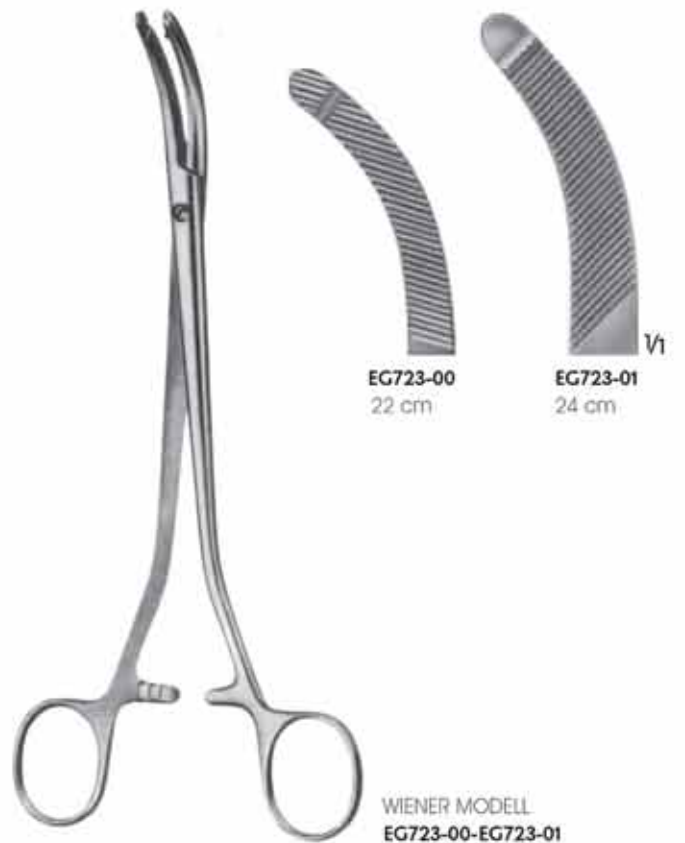

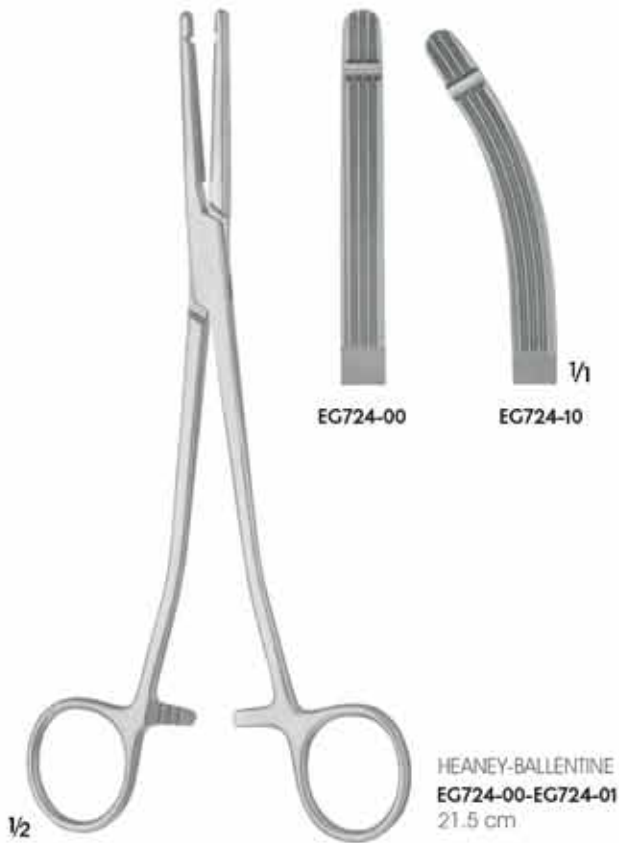
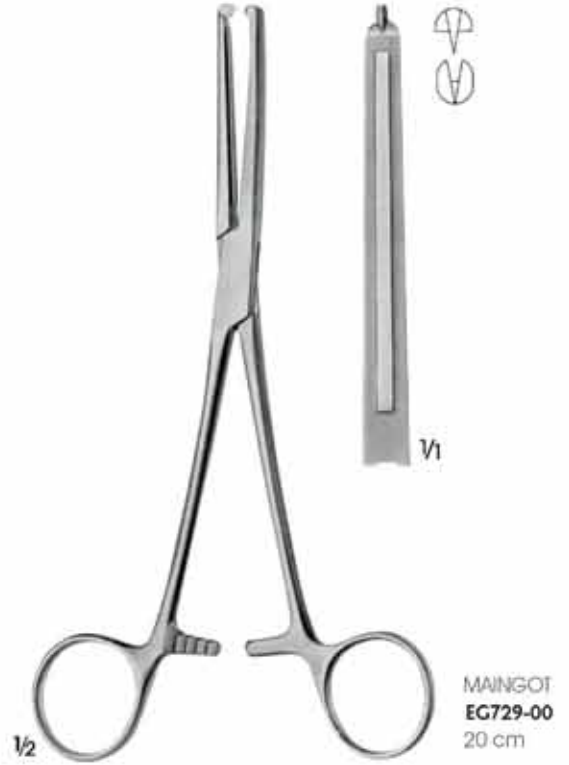



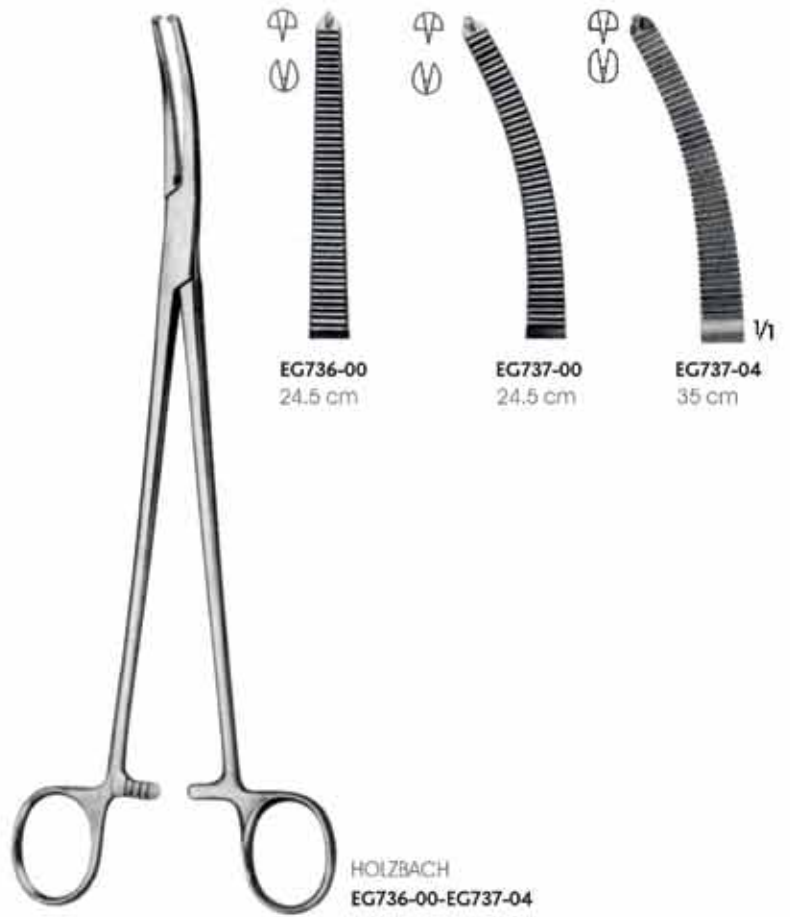
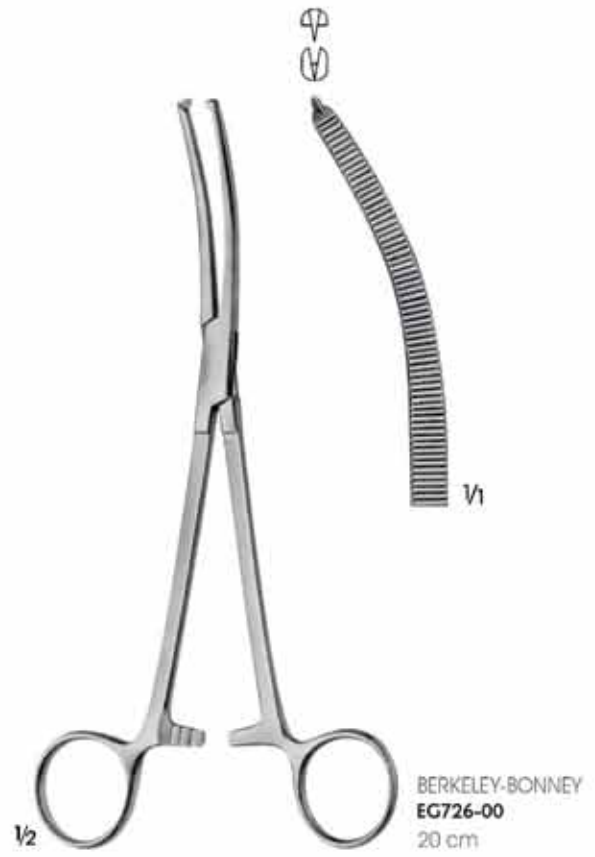
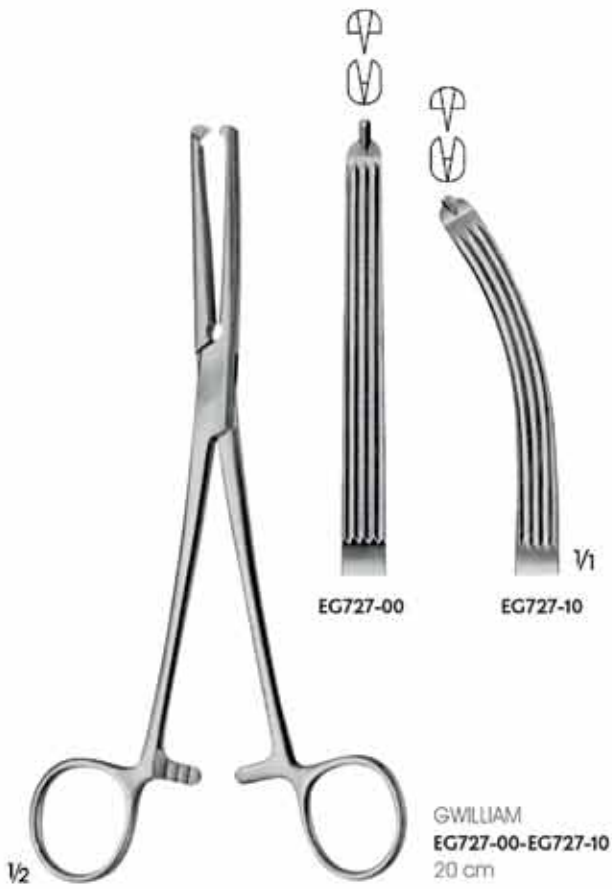



De Bakay Dış



Toothing De BAkey



EG750-00
22.5 cm



EG751-00
22 cm



EG752-00
21.5 cm



EG753-00
20.5 cm



HEANEY
EG750-00-EG753-00



EG754-00
25 cm



EG755-00
24.5 cm



EG756-00
24 cm



EG757-00
22 cm



WERTHEIM
EG754-00-EG757-00

De Bokey Diş



Toothing De BAkey



EG758-00
25 cm



EG758-04
35 cm



EG758-10
25 cm



EG758-11
35 cm

KIEBACK

EG758-00-EG758-04
EG758-10-EG758-11





WERTHEIM
EG760-00
25.5 cm



WERTHEIM
EG766-00
26 cm

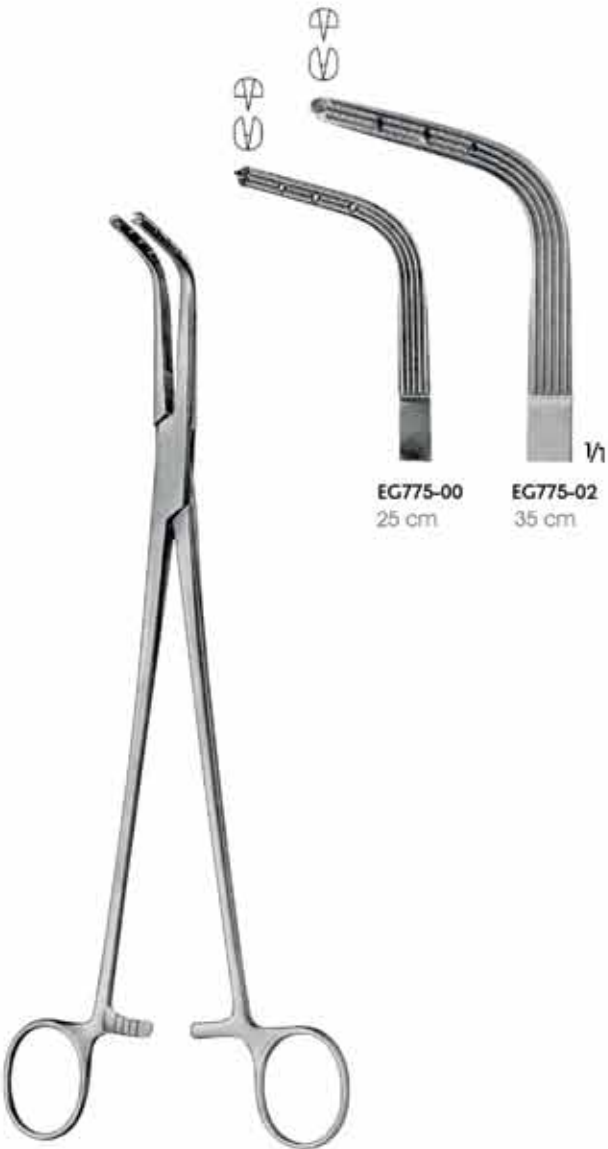

BURKE
EG775-00-EG775-02
Parametrium pensli kısa ağız
Parametrium clamp, short jaw part



BURKE
EG776-00-EG776-02
Parametrium pensli uzun ağız
Parametrium clamp, long jaw part





De Bokey Diş



Toothing De BAkey





EH204-00-EH204-01
23 cm



WERTHEIM-CULLEN
EG771-00
21.5 cm



EH

Kalp Damar ve Göğü Cerrahi
Cardiovascular and Thoracic Surgery





De Bakey Diş



Toothing De BAkey



MOSQUITO
EH400-00-EH401-00
12.5 cm

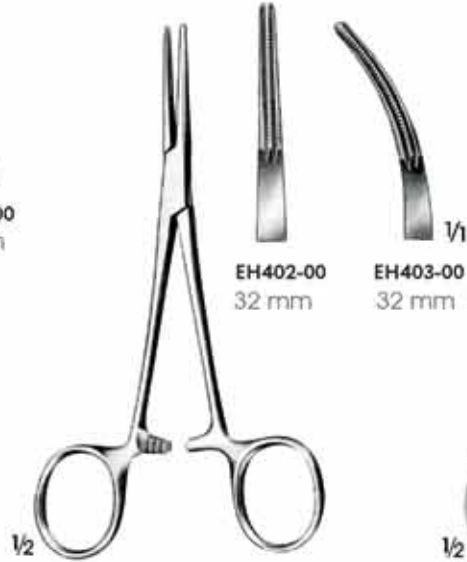

DE BAKEY-KELLY
EH402-00-EH403-00
14 cm

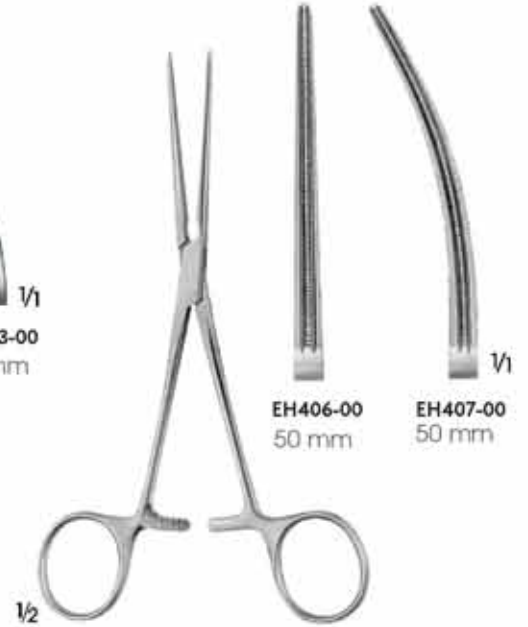

PEAN
EH406-00-EH407-00
15.5 cm



DE BAKEY-BAINBRIDGE
EH408-00-EH409-00
15.5 cm

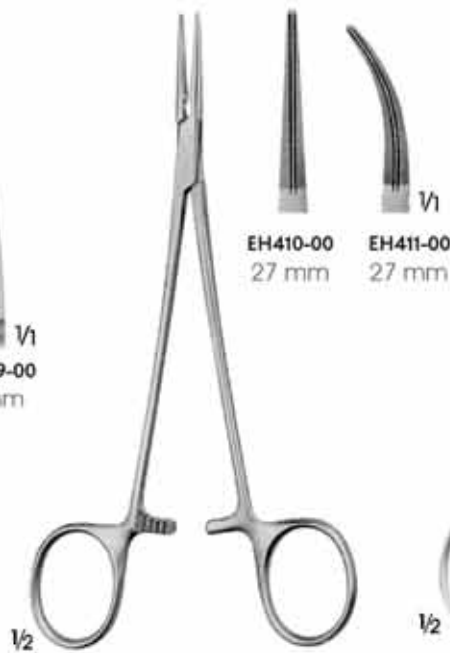

EH410-00-EH411-00
16.5 cm

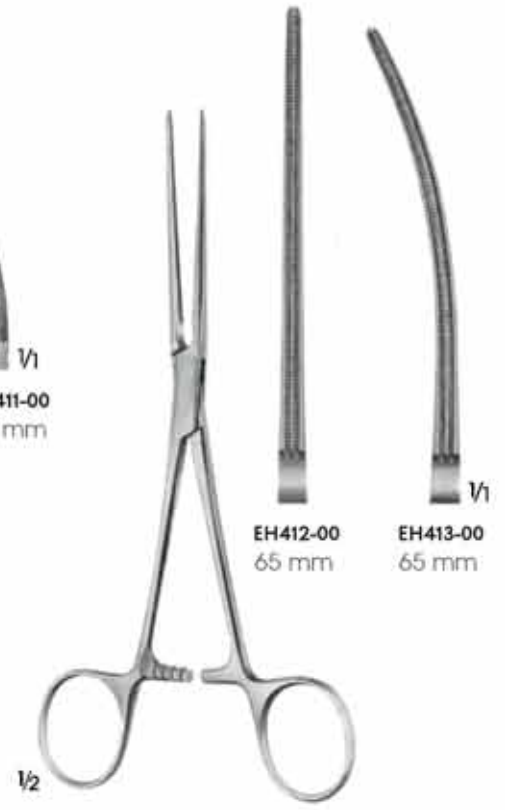

DE BAKEY-BAINBRIDGE
EH412-00-EH413-00
18 cm

De Bakey Diş



Toothing De BAkey



DE BAKEY-PEAN

EH510-00 20 cm

EH510-01 26.5 cm

EH510-02 28 cm

DE BAKEY-PEAN

EH511-00 20 cm

EH511-01 26.5 cm

EH511-02 27.5 cm

EH510-00
60 mm

EH510-01
89 mm

EH510-02
99 mm

EH511-00
60 mm

EH511-01
89 mm

EH511-02
99 mm

1/1





De Bakey Diş



Toothing De BAkey



DE BAKEY
EH520-00
Düz/Straight
13 cm



DE BAKEY
EH521-00
Eğri/Curved
12.5 cm

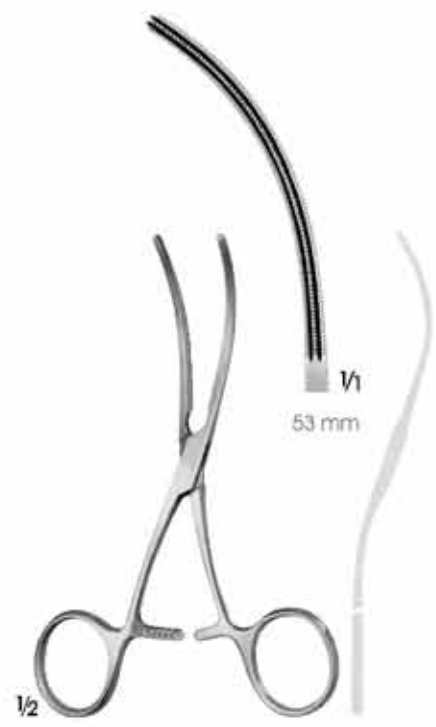

DE BAKEY
EH522-00
S-Biçimli/S-shaped
12.5 cm



DE BAKEY
EH524-00
90° açılı/Angled 90°
10.5 cm



NOON
EH525-00
40° açılı/Angled 40°
11 cm

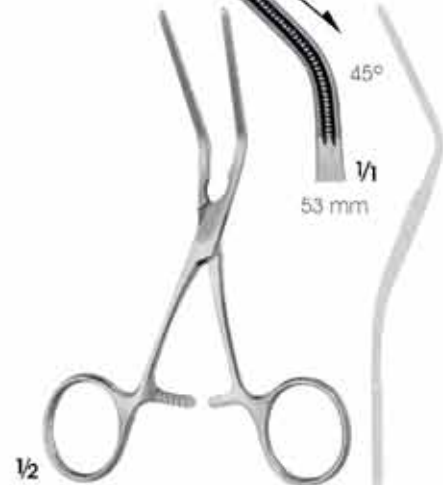
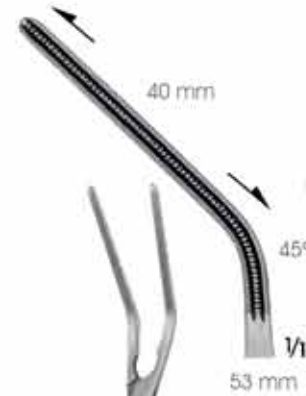

DE BAKEY
EH523-00
45° açılı/Angled 45°
12.5 cm

De Bakıy Diş



Toothing De BAkey



CASTANEDA

- EH530-00 12.5 cm
- EH531-00 12 cm
- EH532-00 12 cm
- EH533-00 10.5 cm

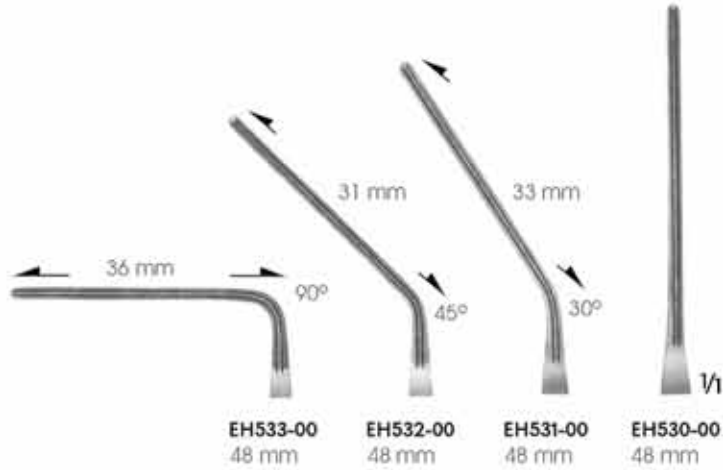

CASTANEDA

- EH540-00-EH540-03
- 15.5 cm





De Bakey Diş



Toothing De BAkey



DE BAKEY
EH545-00-EH545-01

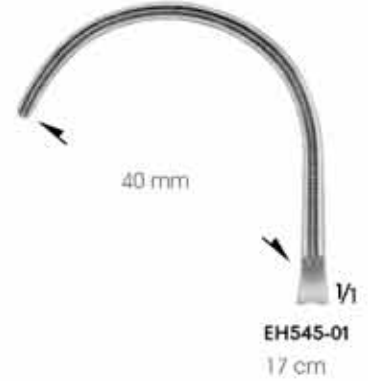

COOLEY
EH550-00-EH552-00

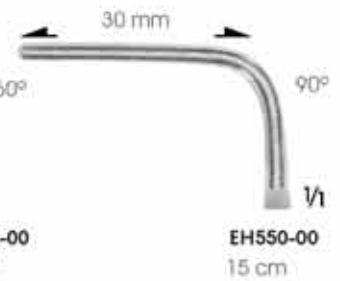
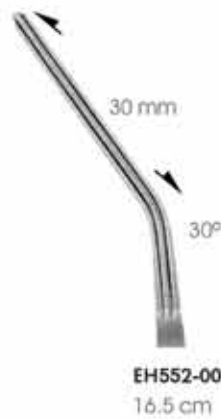

De Bakey Diş



Toothing De BAkey



DERRA
EH554-00-EH554-02



EH554-00
17 cm



EH554-01
17 cm

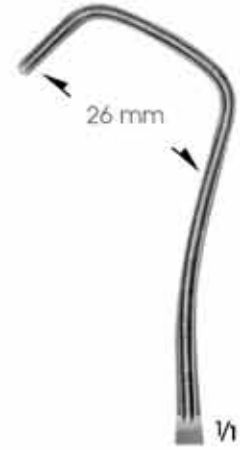

EH554-02
17.5 cm

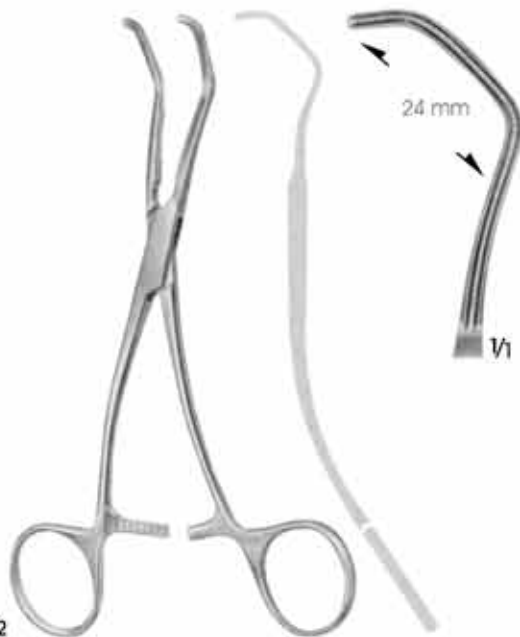

COOLEY
EH556-00
16 cm



COOLEY
EH562-00
20 cm





De BAkey Diş



Toothing De BAkey

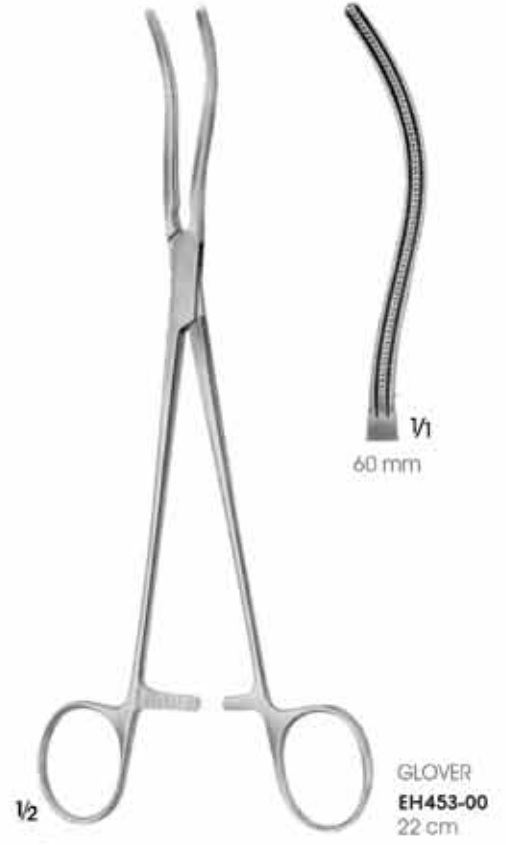

De Bakey Diş



Toothing De BAkey



DE BAKEY-BECK

EH564-00 20.5 cm

EH564-00 21 cm



EH564-00
65 mm

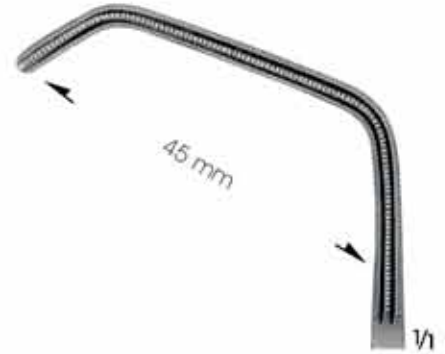

EH564-01
80 mm



DE BAKEY-HARKEN

EH566-00 25.5 cm

EH567-00 24.5 cm

EH568-00 24.5 cm

EH569-00 24.5 cm



EH566-00
86 mm



EH567-00
86 mm



EH568-00
86 mm



EH569-00
86 mm





De Bakey Diş



Toothing De BAkey

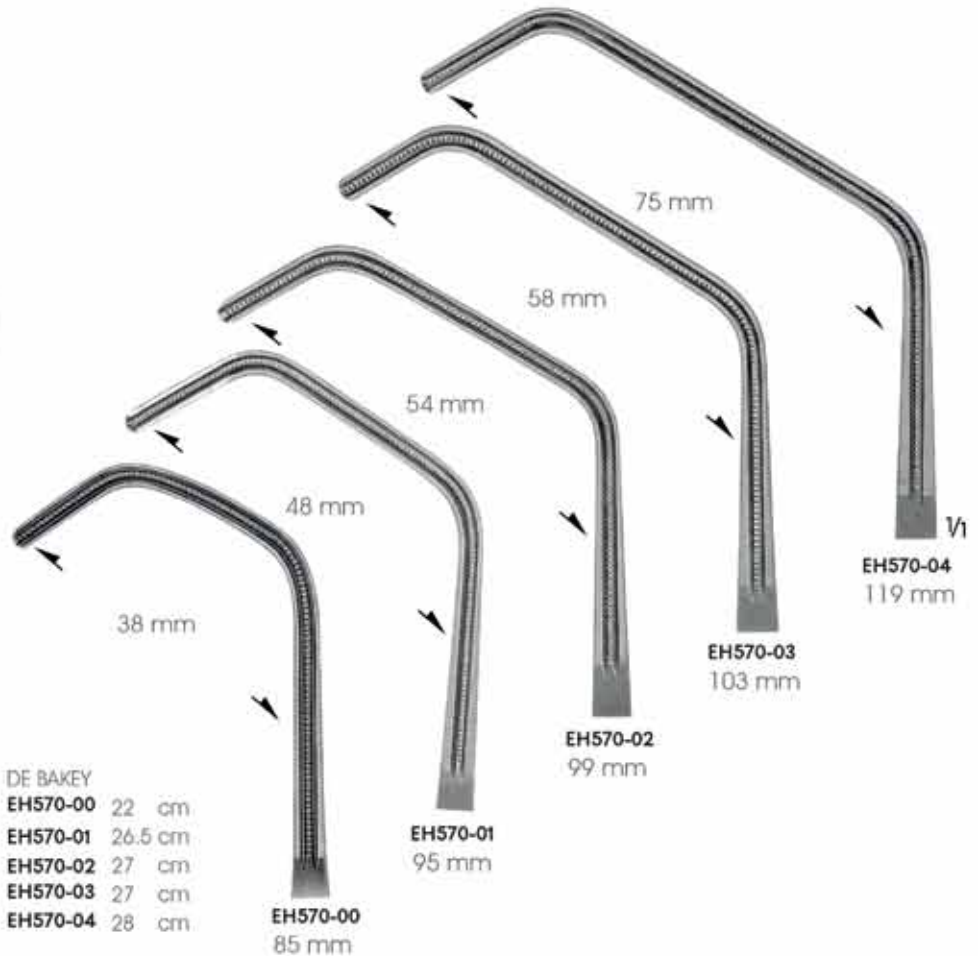

DE BAKEY	
EH570-00	22 cm
EH570-01	26.5 cm
EH570-02	27 cm
EH570-03	27 cm
EH570-04	28 cm

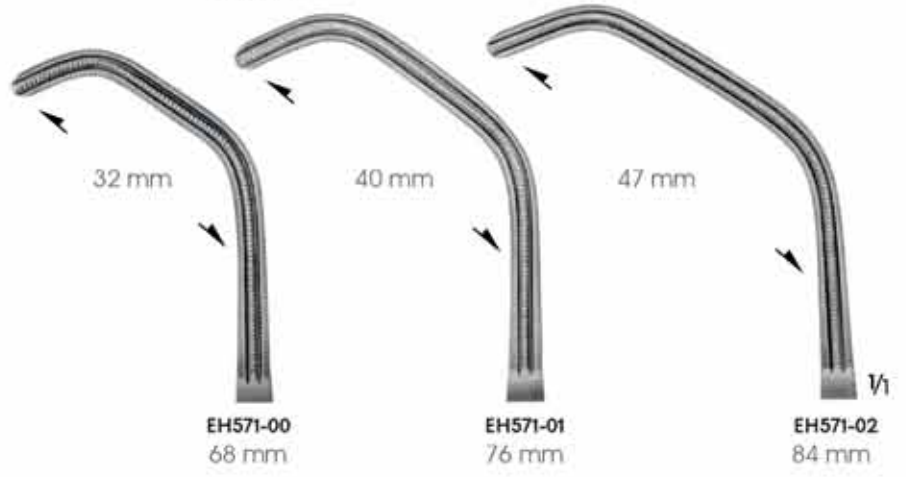

DE BAKEY-SATINSKY	
EH571-00	23.5 cm
EH571-01	24 cm
EH571-02	24.5 cm

De Bakey Diş



Toothing De BAkey



DE BAKEY
EH422-00
21 cm



DE BAKEY
EH423-00
21 cm



DE BAKEY
EH450-00
16 cm

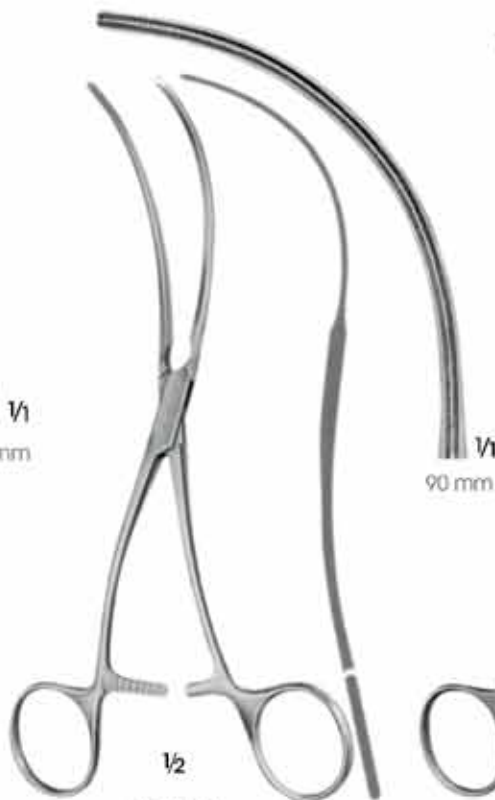

DE BAKEY
EH451-00
19 cm

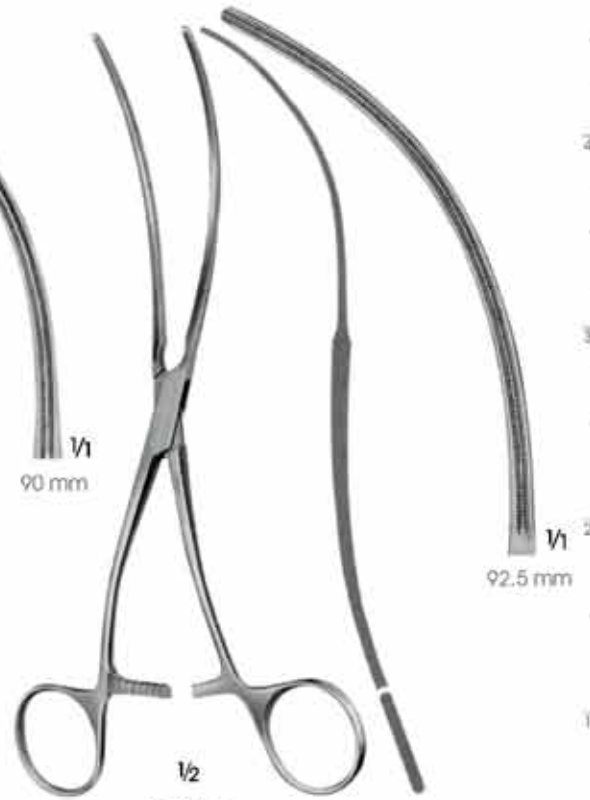

DE BAKEY
EH451-01
20 cm





De Bakey Diş



Toothing De BAkey

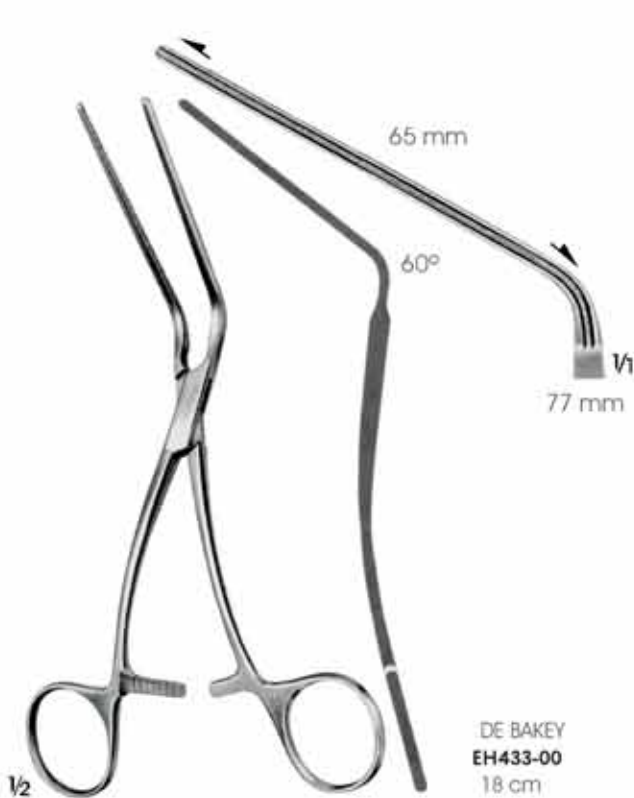
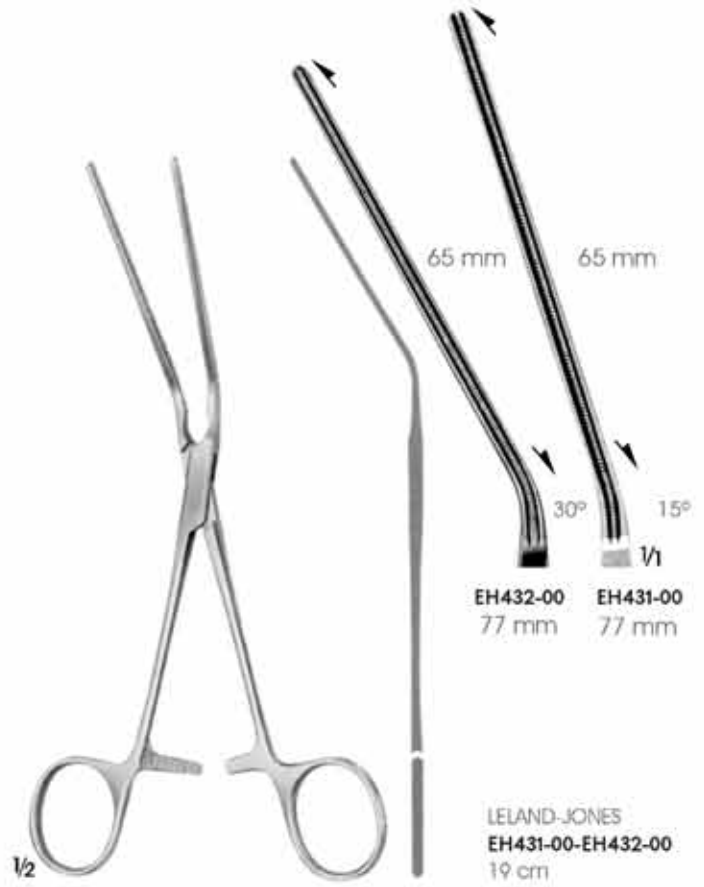

De Bakey Diş



Toothing De BAkey

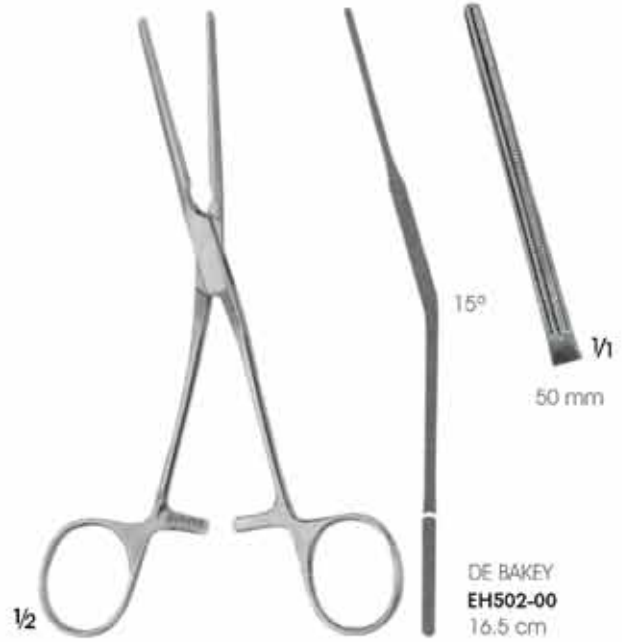
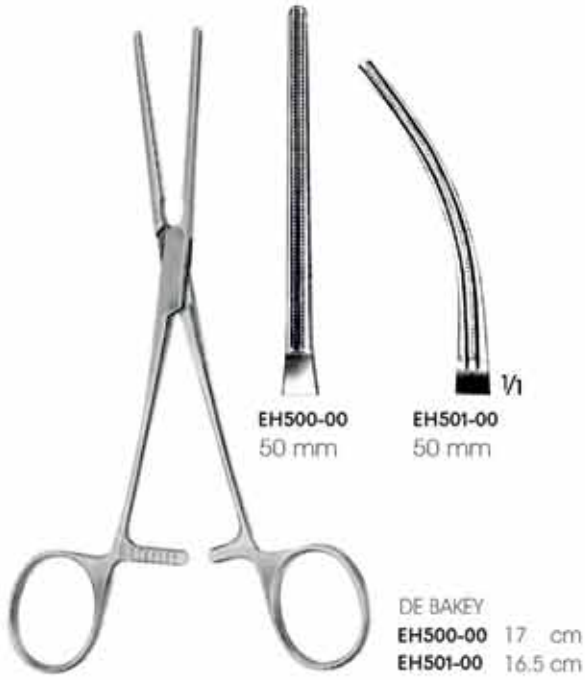

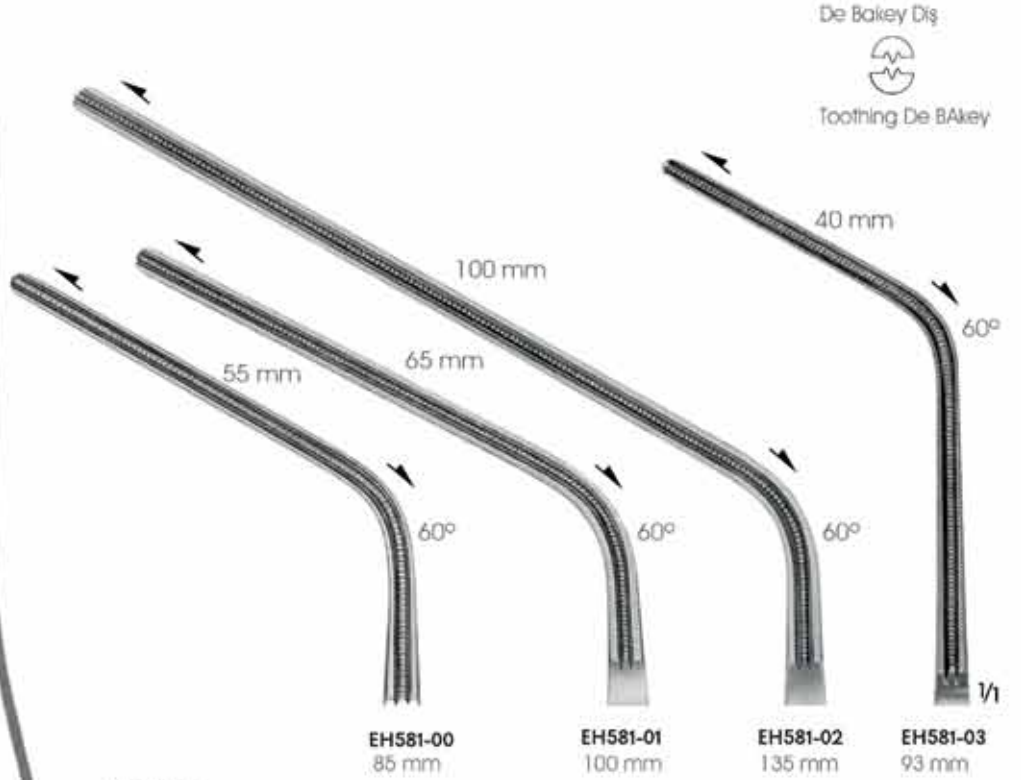

DE BAKLEY	
EH581-00	23 cm
EH581-01	28 cm
EH581-02	30,5 cm
EH581-03	24 cm

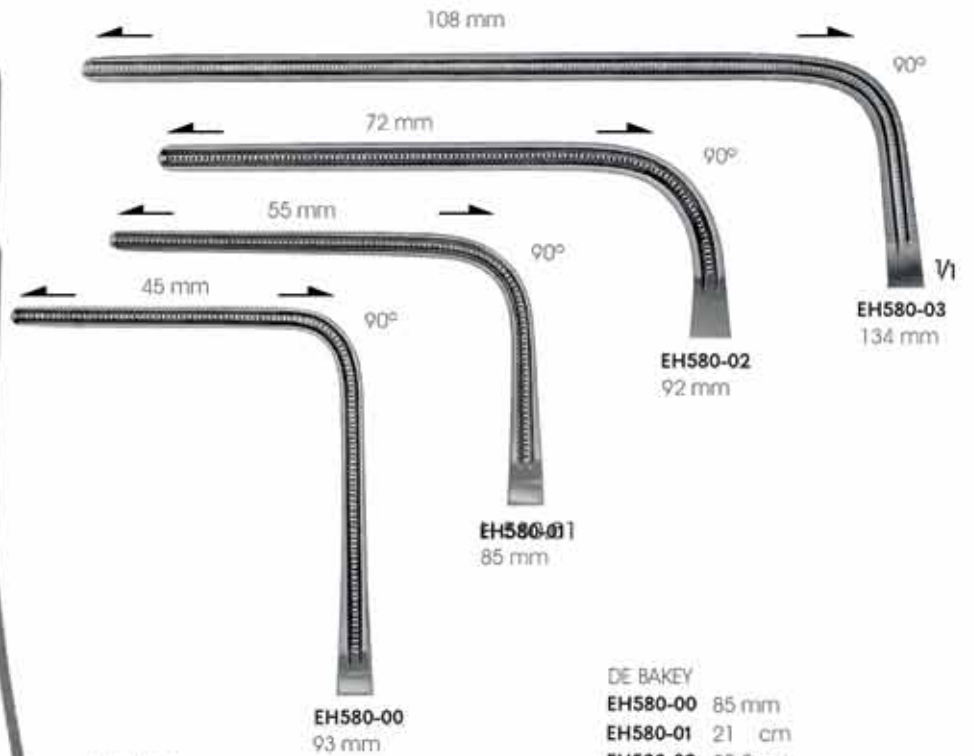

DE BAKLEY	
EH580-00	22,5 cm
EH580-01	21 cm
EH580-02	25,5 cm
EH580-03	27,5 cm

DE BAKLEY	
EH580-00	85 mm
EH580-01	21 cm
EH580-02	25,5 cm
EH580-03	27,5 cm

De Bakey Diş



Toothing De BAkey

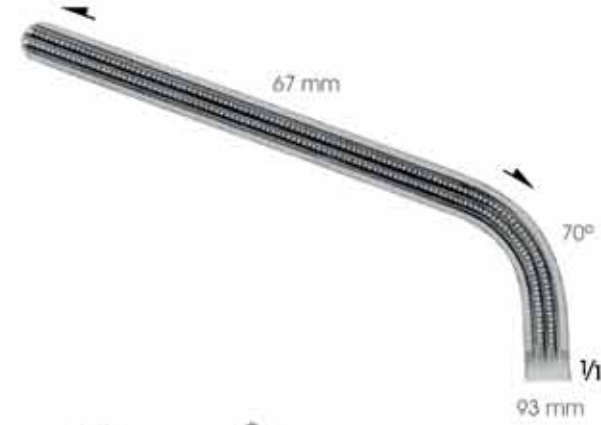

MORRIS
EH460-00
17.5 cm



DE BAKEY
EH461-00
24 cm





De Bakey Diş



Toothing De BAkey

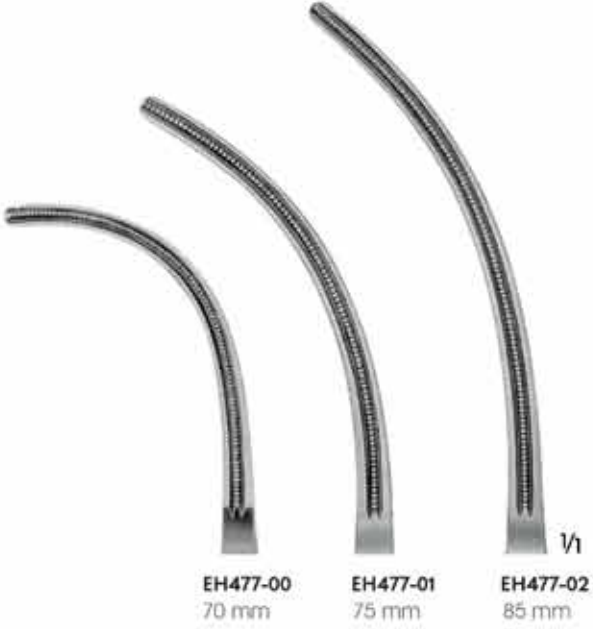

EH477-00
70 mm

EH477-01
75 mm

EH477-02
85 mm



DE BAKEY
EH477-00 25.5 cm
EH477-01 26.5 cm
EH477-02 28 cm

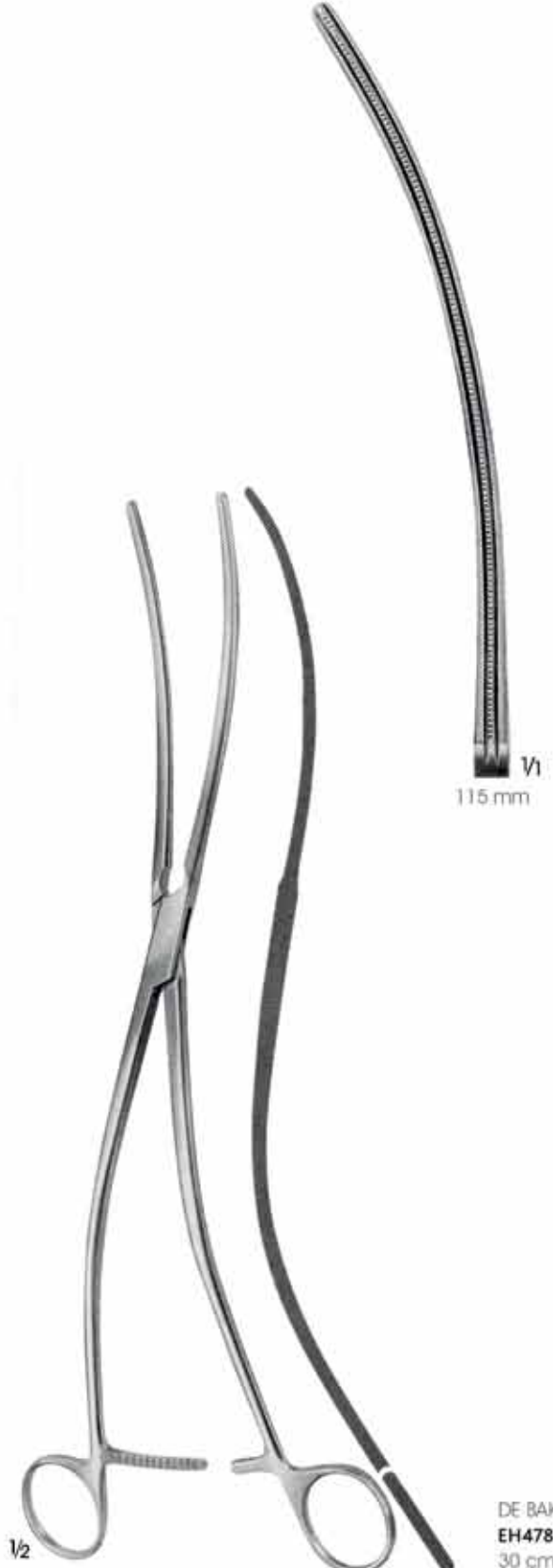

115 mm

DE BAKEY
EH478-00
30 cm

De Bakey Diş



Toothing De BAkey



DE BAKEY
EH480-00
26.5 cm



DE BAKEY
EH481-00
27 cm





De Bakey Diş



Toothing De BAkey

2 x 3 sıra diş



2 x 3 teeth rows

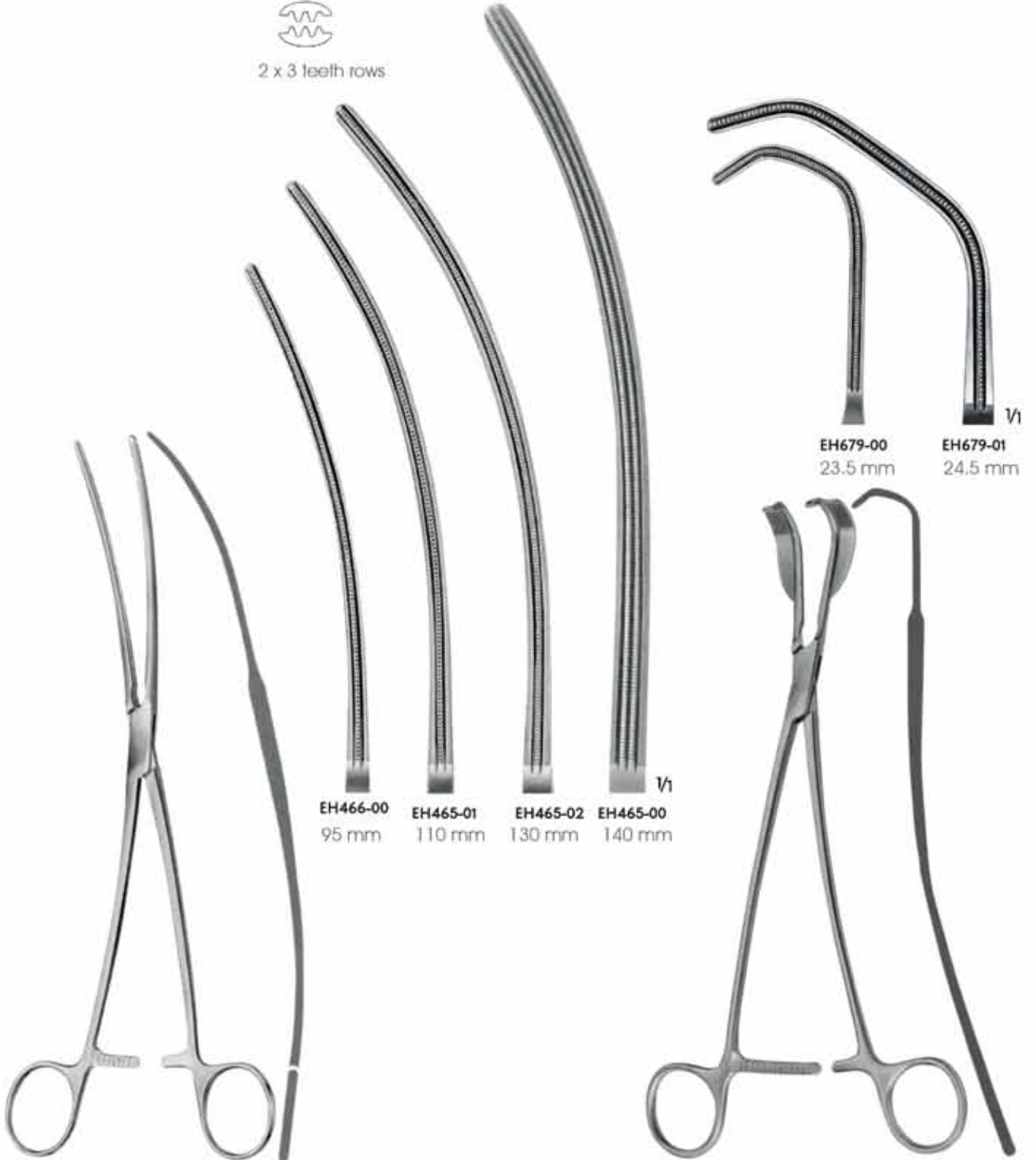

DE BAKEY
EH465-00 25 cm
EH465-01 30 cm
EH465-02 31.5 cm
EH466-00 33 cm

ALLENBERG
EH679-00 EH679-01
Anastomoz sırasına ince dokuların
ayrılmasında kullanılan bıçaklı ayırıcılar
With retraction blades for retraction
of soft tissue during the anastomosis

De Bakay Diş



Toothing De BAkey

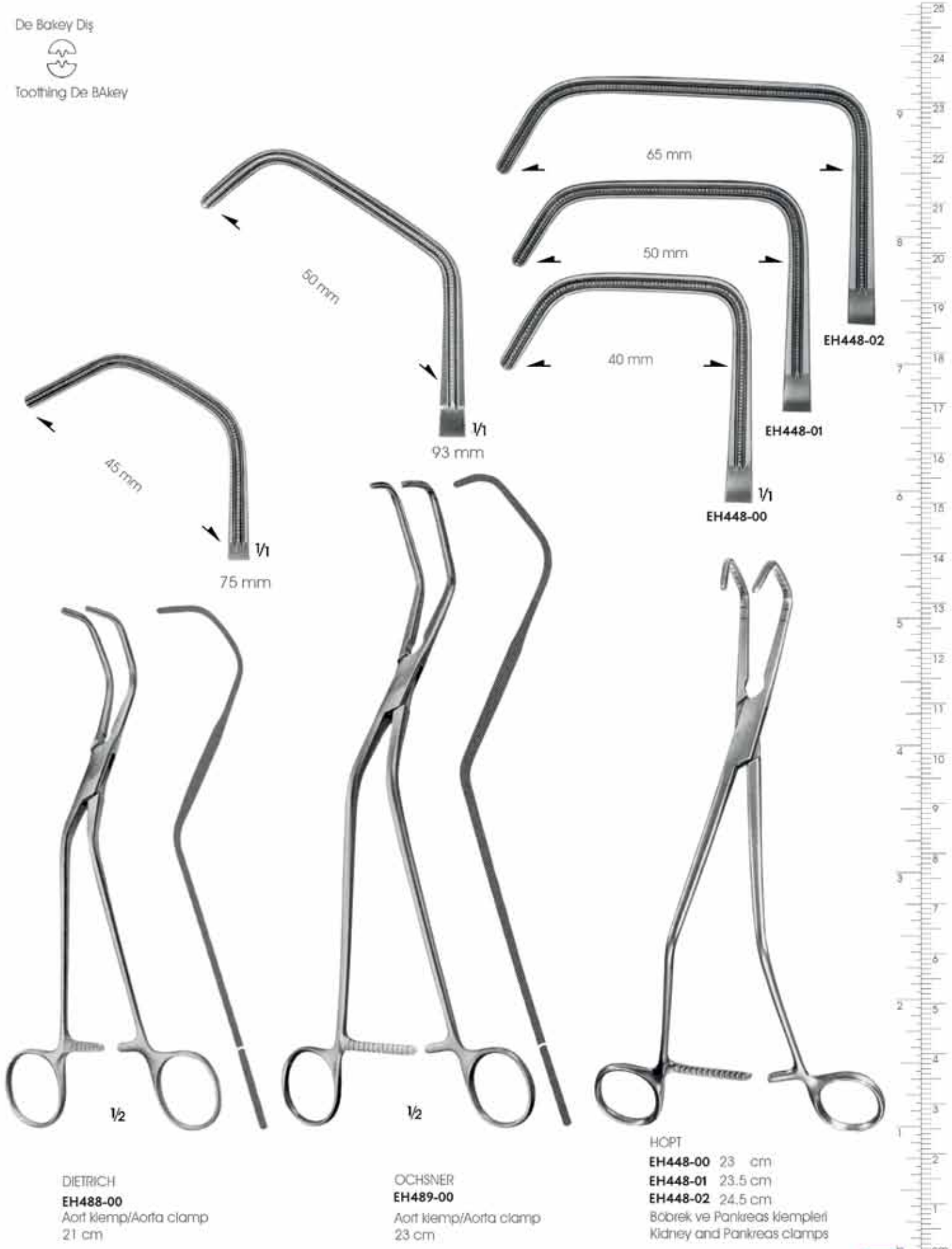

DIETRICH
EH488-00
Aort klem/Aorta clamp
21 cm

OCHSNER
EH489-00
Aort klem/Aorta clamp
23 cm

HOPT
EH448-00 23 cm
EH448-01 23.5 cm
EH448-02 24.5 cm
Böbrek ve Pankreas klempleri
Kidney and Pankreas clamps



De Bakey Diş



Toothing De BAkey

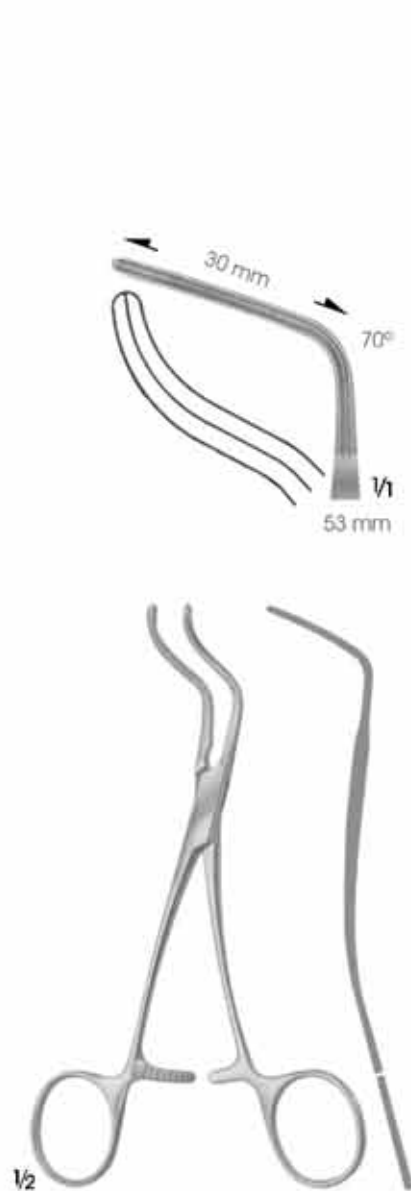

SUBRAMANIAN
EH576-00
15.5 cm



DE BAKEY
EH577-00
26.5 cm

De Bakey Diş



Toothing De BAkey



WEBER
EH484-00
Sol/Left
26 cm



WEBER
EH485-00
Sağ/Right
26 cm

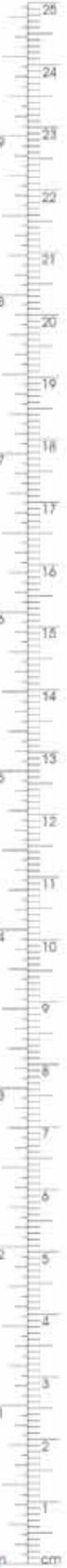



De Bakey Diş



Toothing De BAkey

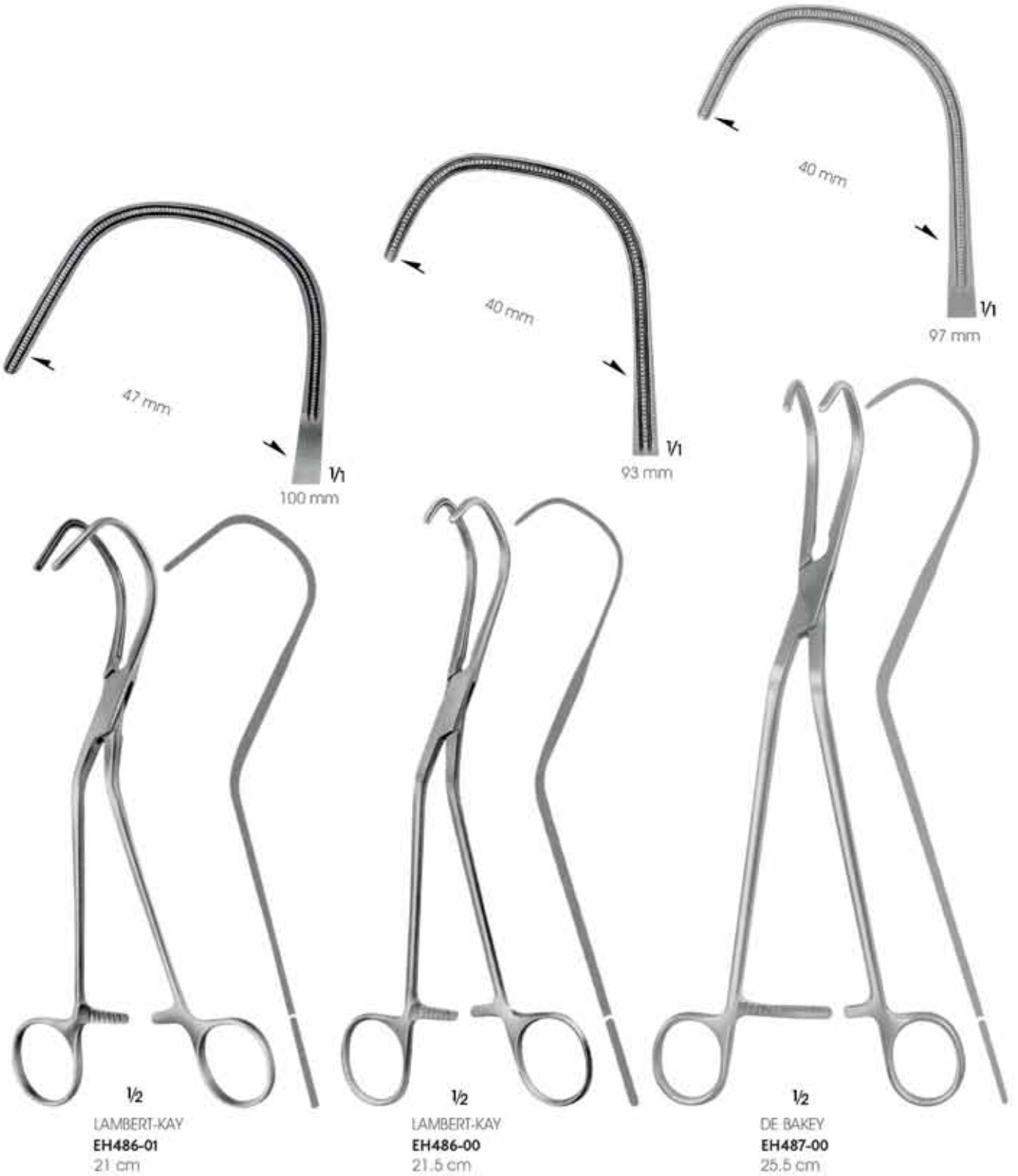

De Bakey Diş



Toothing De BAkey



LEES
EH572-00
22 cm



LEES
EH573-00
24.5 cm



DE BAKEY-MC QUIGG-MIXTER
EH444-00
21 cm



De Bakey Diş



Toothing De BAkey



GREGORY
EH435-03 57 mm
EH435-04 62 mm
Profunda klempler
Profunda clamps
20 cm



DE BAKEY
EH440-00 21 cm
EH440-01 23 cm



DE BAKEY
EH442-00 19 cm
EH442-01 23 cm



DE BAKEY
EH445-00 24 cm

De Bakey Diş



Toothing De BAkey



81 mm



81 mm



80 mm



1/2

DE BAKEY-RUMEL
EH447-00
25 cm



1/2

DE BAKEY-RUMEL
EH446-00
24.5 cm



1/2

DE BAKEY-MIXTER
EH449-00
28.5 cm





De Bakey Diş



Toothing De BAkey



EH204-01
80 mm



EH204-00
60 mm



EH200-00
78 mm

EH200-01
88 mm

EH200-02
98 mm



EH204-00-EH204-01
Bronş pensler
Bronchus forceps
23 cm

1/2



DICK
EH200-00 25.5 cm
EH200-01 26.5 cm
EH200-02 27.5 cm
Anastomoz klempler
Anastomosis clamps

De Bakey Diş
2 x 3 sıra diş



2 x 3 teeth rows
Toothing De BAkey

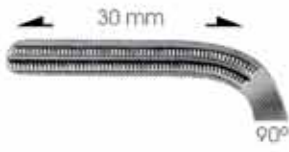

EH770-00
38 mm



EH771-00
38 mm



EH772-00
38 mm



EH773-00
38 mm



EH774-00
38 mm

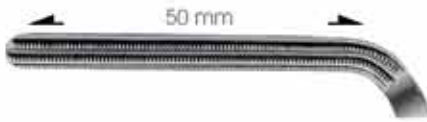

EH770-01
58 mm



EH771-01
58 mm



EH772-01
58 mm



EH773-01
58 mm



EH774-01
58 mm



EH770-00 13 cm
EH771-00 14,5 cm
EH772-00 15 cm
EH773-00 15 cm
EH774-00 15 cm

EH770-01 13,5 cm
EH771-01 16 cm
EH772-01 17 cm
EH773-01 17 cm
EH774-01 17 cm





Cooley Dig



Toothing Cooley

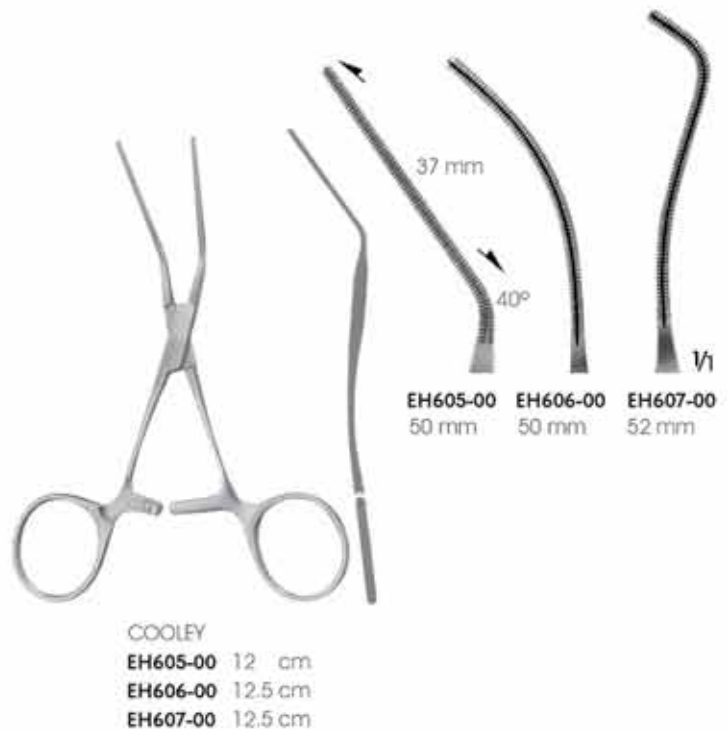
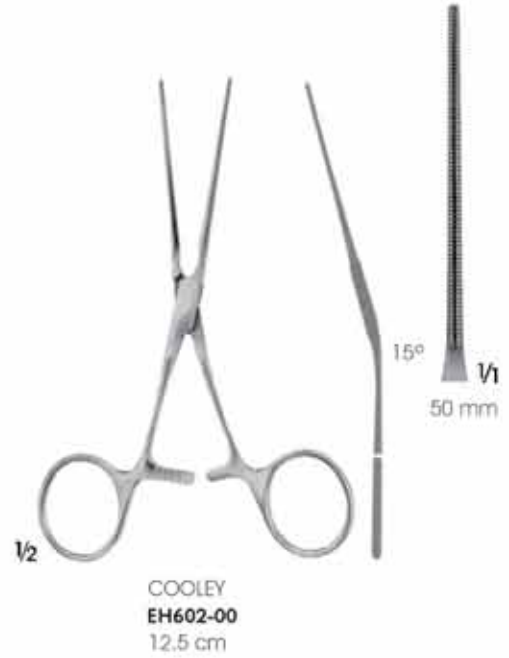

Cooley Diş



Toothing Cooley



COOLEY
EH608-00 12 cm
EH609-00 11.5 cm

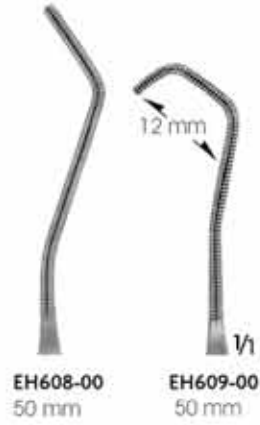

COOLEY
EH611-00
14.5 cm



COOLEY
EH612-00
14 cm



COOLEY
EH613-00
14.5 cm

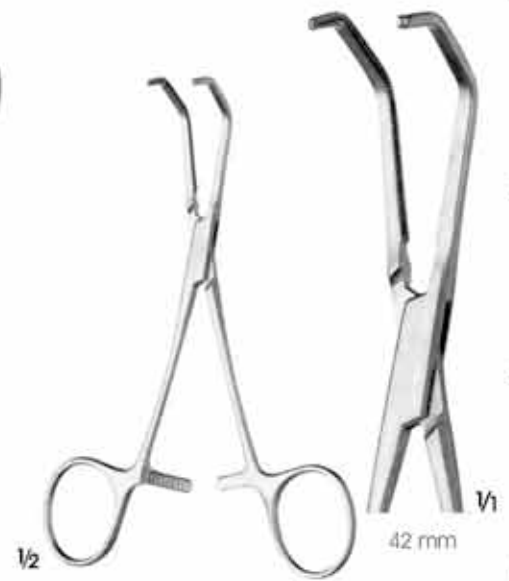

SATINSKY
EH615-00
14 cm





Cooley Dig



Toothing Cooley



COOLEY-BECK
EH620-00 15 cm
EH620-01 15.5 cm



COOLEY
EH621-01-EH621-02
17 cm

Cooley Diş



Toothing Cooley



EH630-00
71 mm



EH630-01
76 mm

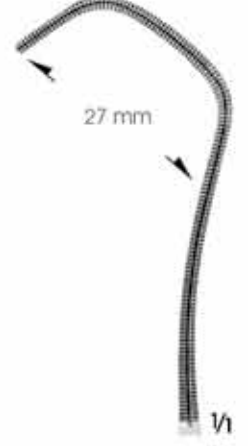

EH630-02
80 mm

DERRA-COOLEY

EH630-00 17 cm

EH630-01 17.5 cm

EH630-02 17.5 cm

Anastomoz klempler/Anastomosis clamps

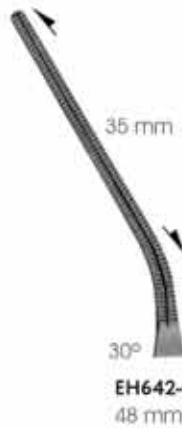

EH642-00
48 mm



EH641-00
52 mm

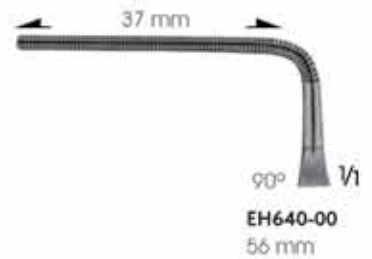

EH640-00
56 mm

COOLEY

EH640-00 15 cm

EH641-00 16 cm

EH642-00 16.5 cm

Çok amaçlı klempler/Multi Purpose clamps





Cooley Dış



Toothing Cooley



EH631-00
72 mm

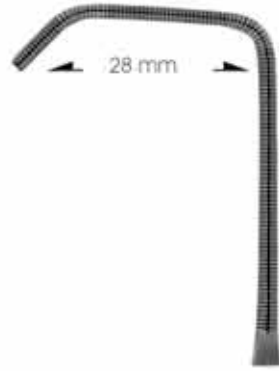

EH631-01
76 mm

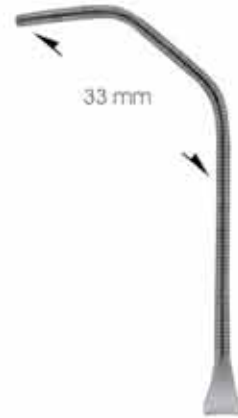

EH631-02
72 mm

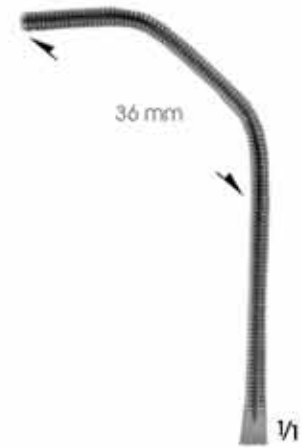

EH631-03
76 mm



COOLEY
EH631-00 16.5 cm
EH631-01 16.5 cm
EH631-02 17.5 cm
EH631-03 18 cm

Cooley Diş



Toothing Cooley



43 mm

1/16



70 mm

1/16



LEITZ
EH643-00
20.5 cm

1/2



PARRY-COOLEY
EH644-00
29.5 cm

1/2





Cooley Diş



Toothing Cooley



Cooley Dis.



Toothling Cooley

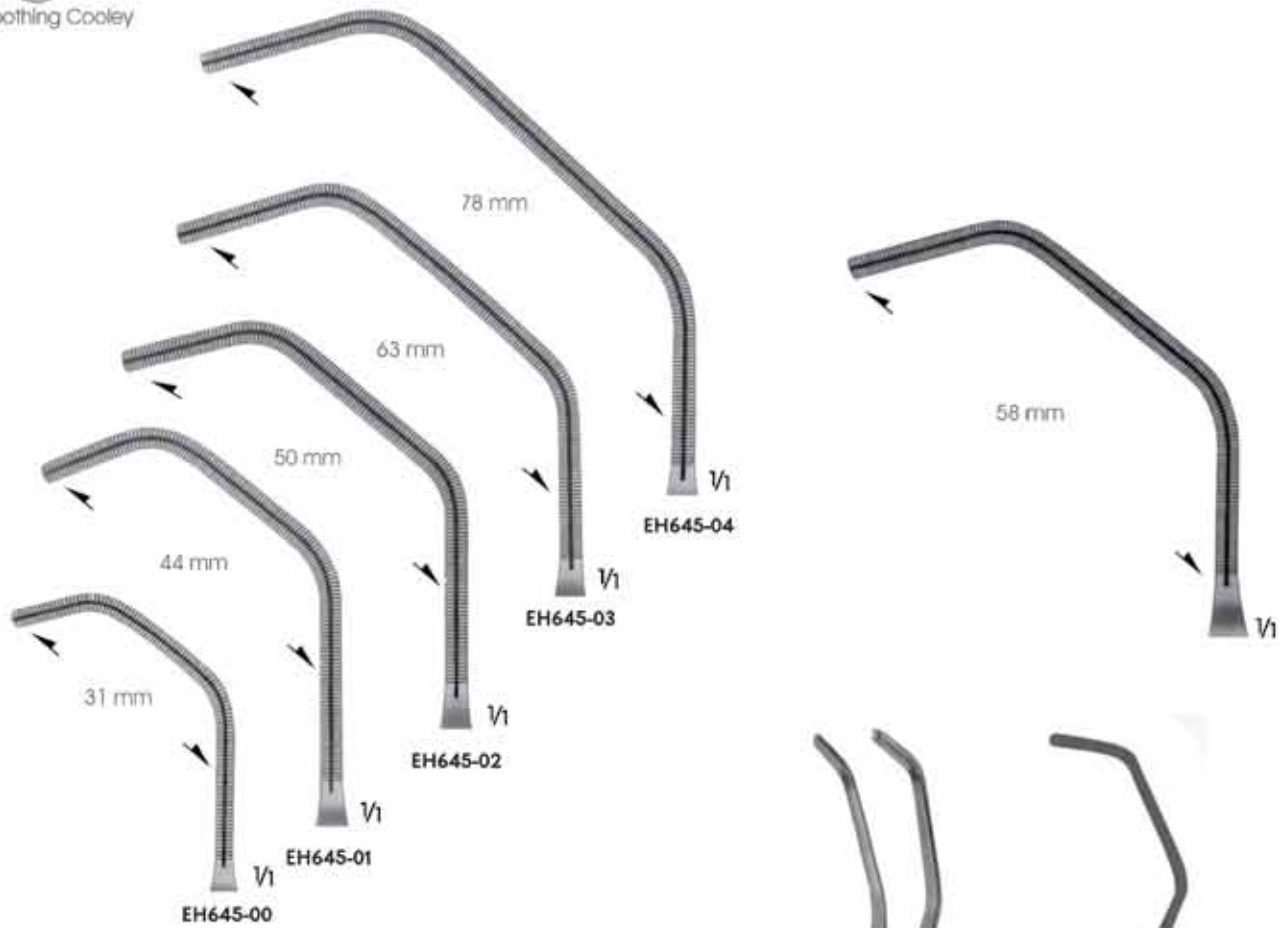

COOLEY
EH645-00 20.5 cm
EH645-01 26 cm
EH645-02 26.5 cm
EH645-03 26.5 cm
EH645-04 27.5 cm



COOLEY
EH647-04 26 cm





Cooley Dig



Toothing Cooley

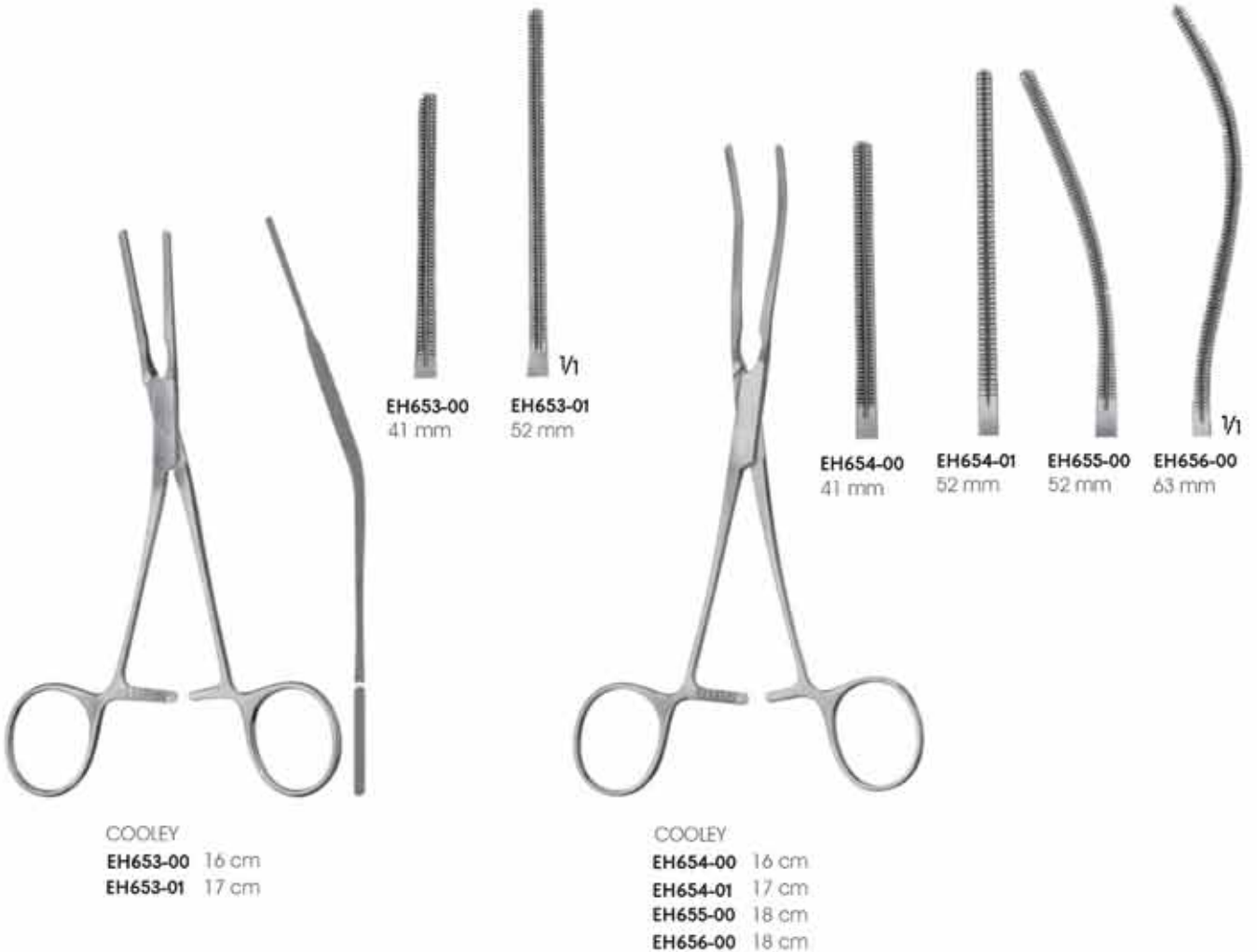

Cooley Diş



Toothing Cooley

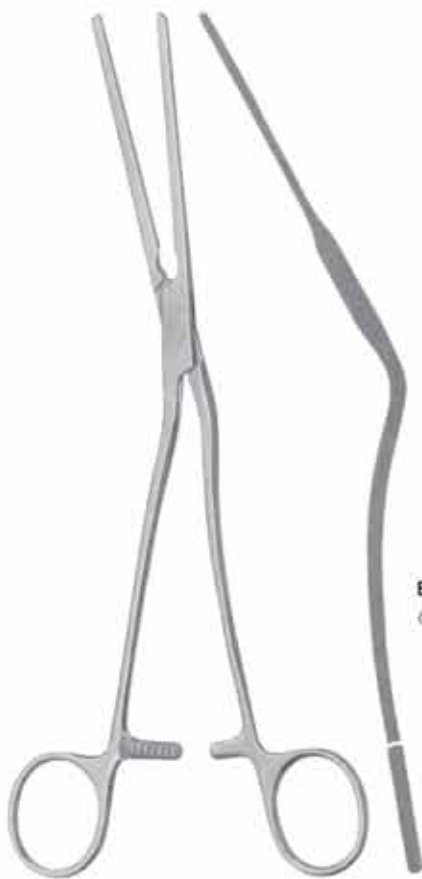
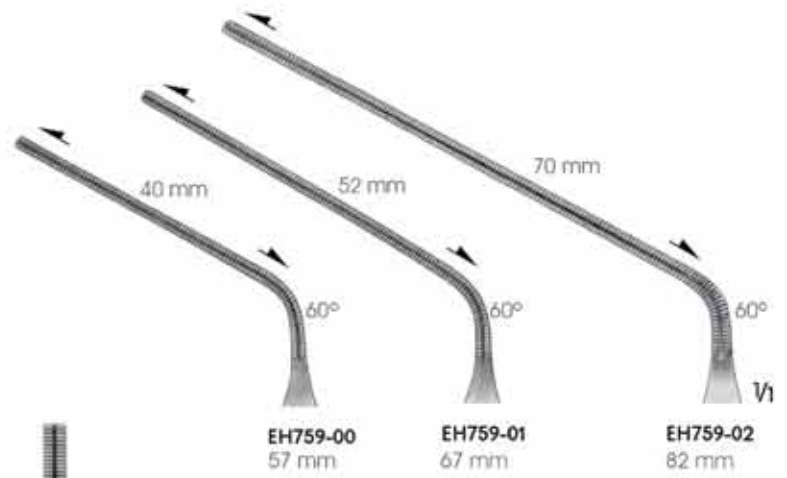

EH758-00 22.5 cm
EH758-01 27 cm



COOLEY
EH759-00 16.5 cm
EH759-01 17 cm
EH759-02 18.5 cm





Cooley Diş



Toothing Cooley



1/2

COOLEY
EH755-00
22 cm

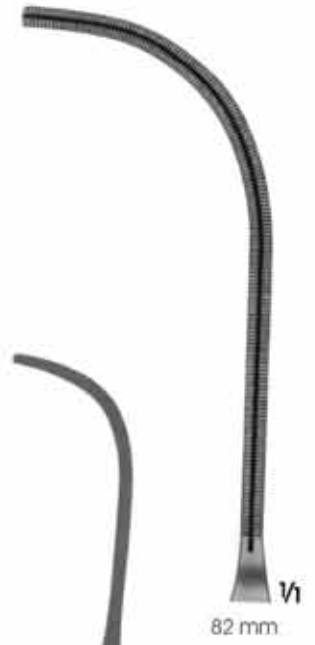

1/2

COOLEY
EH756-00
28.5 cm

Cooley Disj



Toothing Cooley



COOLEY
EH757-00
32 cm

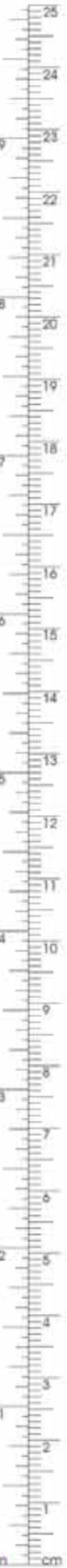

EJ

Sondlar, Aspiratör Uçları, Trokarlar ve Biyopsi İğneleri
Probes, Suction Tubes, Trocars and Biopsy Needles

Ø 2.0 mm



EJ030-00 13 cm
EJ030-01 14.5 cm
EJ030-02 16 cm
EJ030-03 18 cm
EJ030-04 20 cm
Mirtle yaprak sondalar
Myrtle leaf probes

Ø 1.5 mm



1/2
EJ031-00
Mirtle yaprak sonda
Myrtle leaf probe
14.5 cm



EJ035-00 Ø 2.5 mm
14.5 cm
EJ035-01 Ø 2.5 mm
16 cm
EJ035-02 Ø 3.0 mm
20 cm
Delikli sondalar
Probes with eye

Uc çapı

Diameter of tip

1 mm

-

EJ033-01

-

-

-

-

-

-

1.5 mm

EJ033-07

EJ033-08

EJ033-09

EJ033-10

EJ033-11

EJ033-12

-

-

2 mm

-

EJ033-15

EJ033-16

EJ033-17

EJ033-18

-

EJ033-20

Uzunluk

Length

13 cm

14.5 cm

16 cm

18 cm

20 cm

25 cm

30 cm

EJ033-01-EJ033-20
Sondalar/Probes

Ø 3.5 mm



EJ038-00 25 cm
EJ038-01 30 cm
Çift başlı sondalar
bükülebilir
Double ended probes,
malleable

Ø 4 mm



1/4
EJ039-00
Çift başlı sonda bükül-
ebilir
Double ended probe,
malleable
40 cm

Ø 2.0 mm



1/3
EJ040-01
Sonda/Probe
30 cm

Ø 3 mm



1/2
EJ037-00
Çift başlı sonda bükül-
ebilir, delikli
Double ended probe,
malleable, with hole
19 cm

Ø 1.2 mm



1/2
EJ039-10
Sinus sonda
Sinus probe
15 cm

1/2

EJ035-05
12.5 cm





**KING'S COLLEGE HOSPITAL
EJ044-03**

Pamuk aplikatör
Cotton applicator
Sert burgulu
Rough, spiral end
9 cm

Ø 0.8 mm



**STACKE
EJ042-00**
Sonda/Probe
Gümüş/Silver
10 cm

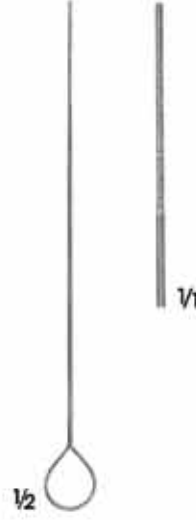

**KING'S COLLEGE HOSPITAL
EJ044-05**

Pamuk aplikatör
Cotton applicator
Sert burgulu
Rough, spiral end
13.5 cm



**CAWTHORNE
EJ044-10**

Sonda/Probe
Yaprak uçlu, gümüş
Flattened end silver
14 cm



BOWMAN
EJ049-00 Ø 0.7 + 0.8 mm
EJ049-01 Ø 0.9 + 1.1 mm
EJ049-02 Ø 1.3 + 1.4 mm
EJ049-03 Ø 1.5 + 1.6 mm
EJ049-04 Ø 1.8 + 1.9 mm
Sondalar/Probes
Gümüş/Silver
13 cm

Ø 0.9 mm



**BUCK
EJ050-00**
Pamuk aplikatör
Cotton applicator
Ucu sert burgulu
Rough, spiral end
12 cm

Ø 1.4 mm



EJ043-00
Sonda/Probe
16 cm

Ø 1 mm



**SEIFFERT
EJ045-00**
Sonda/Probe
Gümüş/Silver
19.5 cm

Ø 1.5 mm



**KILLIAN
EJ047-00**
Sonda/Probe
16.5 cm

Ø 0.7 mm



1/1
PICCOLO
EJ053-00

Aplikatör/Applicator
Ucu yuvarlak tırtilli
Round serrated end
11 cm

Ø 0.7 mm



1/1
PICCOLO
EJ053-01

Aplikatör/Applicator
Ucu üçgen tırtilli
Triangular serrated end
11 cm

Ø 1.2 mm



1/1
FARRELL
EJ055-00

Aplikatör/Applicator
Ucu yuvarlak tırtilli
Round serrated end
11 cm

Ø 1.4 mm



1/1
LATHBURY-FARRELL
EJ056-00

Aplikatör/Applicator
Ucu üçgen tırtilli
Triangular serrated end
11 cm

Ø 2.3 mm

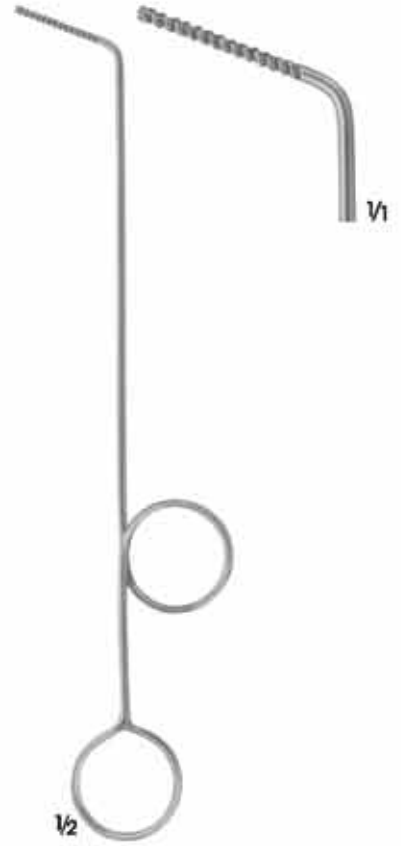

1/2
HARTMANN
EJ065-00

Aplikatör/Applicator
Sert spiral uçlu
Rough, spiral end
22 cm

16 mm



1/2
EICKEN
EJ326-00

İrigasyon kanülü, LUER bağlantılı, hafif eğri
Irrigation cannula, with LUER hub, slightly curved
14.5 cm



1/2
EICKEN
EJ326-10

İrigasyon kanülü, LUER bağlantılı, kısa eğri
Irrigation cannula, with LUER hub, shortly curved
14.5 cm



1/2
EJ036-00

Spatula/Spatula
14.5 cm



1/2
EJ580-00

Spatula/Spatula
14.5 cm



FERGUSSON				
Çalışma boyu Working length	11 cm	13 cm	16 cm	20 cm
Tam boy Total Length	19,5 cm	21,5 cm	24,5 cm	28 cm
EJ215-01	EJ215-21	EJ215-51	EJ215-81	1,5 mm
EJ215-02	EJ215-22	EJ215-52	EJ215-82	2,0 mm
EJ215-03	EJ215-23	EJ215-53	EJ215-83	2,5 mm
EJ215-04	EJ215-24	EJ215-54	EJ215-84	3,0 mm
EJ215-06	EJ215-26	EJ215-56	EJ215-86	4,0 mm
EJ215-08	EJ215-28	EJ215-58	EJ215-88	5,0 mm

Parmak kumandalı, temizleme telli
parmak basma yüzeyi yatay LUER bağlantı
With finger cut-of and styled
Thumb piece 90° to curve. With LUER hub



Olive
Ø 6-9 mm

FERGUSSON

EJ220-02 Ø 4 mm
İzoleli, parmak kumandalı,
temizleme telli
parmak basma yüzeyi yatay
LUER bağlantı
Isolated, with finger cut-of and stylet.
Thumb piece 90° to curve, with LUER
hub
18 cm

1/2

Olive
Ø 6-9 mm

FRAZIER

EJ220-00 Ø 3 mm
EJ220-01 Ø 5 mm
Parmak kumandalı, temizleme
telli parmak basma yüzeyi
yatay LUER bağlantı
With finger cut-of and stylet
Thumb piece 90° to curve,
with LUER hub
18 cm

1/2

FRAZIER

EJ221-00 Ø 2,3 mm
EJ221-01 Ø 2,7 mm
EJ221-02 Ø 3,4 mm
EJ221-03 Ø 4,0 mm
Parmak kumandalı, temizleme
telli parmak basma yüzeyi yatay
LUER bağlantı
With finger cut-of and stylet
Thumb piece 90° to curve,
with LUER hub
11 cm

1/2



ZOELLNER

EJ032-01 Ø 26 swg, Ø 0.4 mm

EJ032-02 Ø 24 swg, Ø 0.5 mm

EJ032-04 Ø 22 swg, Ø 0.7 mm

EJ032-06 Ø 20 swg, Ø 1.0 mm

EJ032-08 Ø 18 swg, Ø 1.2 mm

EJ377-01 ve **EJ378-00** için sökölüp takılabilir uçlar
Detachable ends fitting to **EJ377-01** and **EJ378-00**
10'luk paket/Package of 10 pieces



VERHOEVEN

EJ729-01 Ø 24 swg, Ø 0.5 mm

EJ729-02 Ø 22 swg, Ø 0.7 mm

EJ729-04 Ø 20 swg, Ø 1.0 mm

EJ729-06 Ø 18 swg, Ø 1.2 mm

EJ729-08 Ø 16 swg, Ø 1.5 mm

Aspiratör ucu, LUER koniği
Suction cannulae with Luer cone
10 cm

Olive
Ø 7 mm



HOUSE

EJ461-01

Parmak kumandalı emiş adaptörü LUER koniği, LUER bağlantılı
Suction adapter with finger cut-off, LUER cone, LUER hub
5.5 cm



PLESTER

EJ212-00 Ø 1.5 mm

EJ212-01 Ø 2.0 mm

EJ212-02 Ø 2.5 mm

EJ212-03 Ø 3.0 mm

Parmak kumandalı, temizleme telli parmak basma yüzeyi baş parmağa paralel LUER bağlantılı
With finger cut-off and stylet, thumb piece parallel to curve, with LUER hub
19.5 cm

Olive
Ø 6-9 mm

1/2



ADSON
EJ219-00

Parmak kumandalı
With finger cut-off
19 cm

Olive
Ø 9 mm

1/2



ADSON
EJ232-00

Aspiratör ucu
Suction cannula
Parmak kumandalı ve temizleme telli
With finger cut-off and stylet
16.5 cm

Olive
Ø 8 mm

1/2



GILLIES
EJ227-01 Ø 3 mm
Parmak kumandalı ve
temizleme telli
With finger cut-off and stylet
17 cm



LEMPERT
EJ224-01 Ø 2 mm
EJ224-02 Ø 3 mm
Parmak kumandalı ve
temizleme telli
With finger cut-off and stylet
20 cm



FORMBY
EJ225-01 Ø 3.3 mm
21 cm

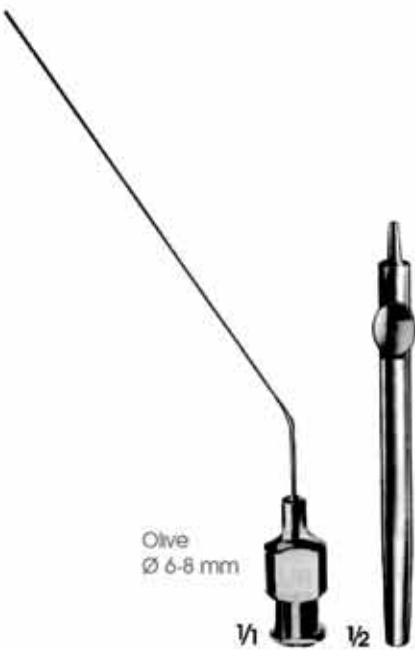

EJ236-10 Komple/Complete
EJ236-00 Sap/Handle
EJ236-01 Ø 0.5 mm
EJ236-02 Ø 0.7 mm
EJ236-03 Ø 1.0 mm
EJ236-04 Ø 1.3 mm
LUER koniği/With LUER cone



WULLSTEIN
EJ238-10 Komple/Complete
EJ238-00 LUER bağlantılı sap
handle with LUER hub
EJ238-01 Ø 0.4 mm
EJ238-02 Ø 0.6 mm
EJ238-03 Ø 0.8 mm



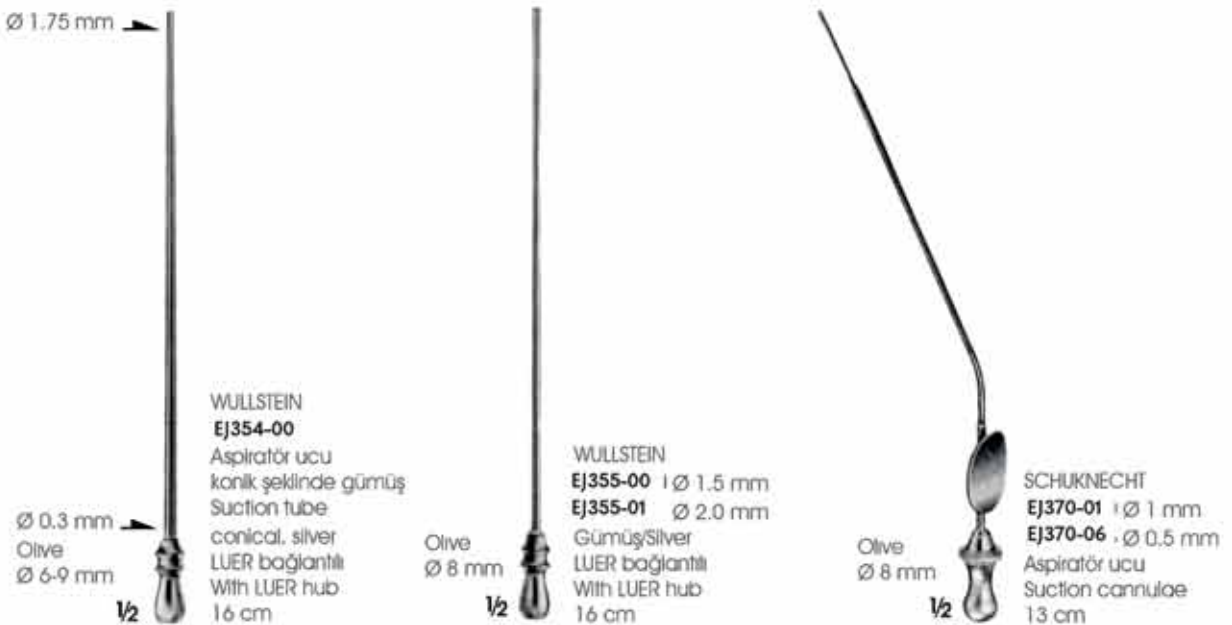
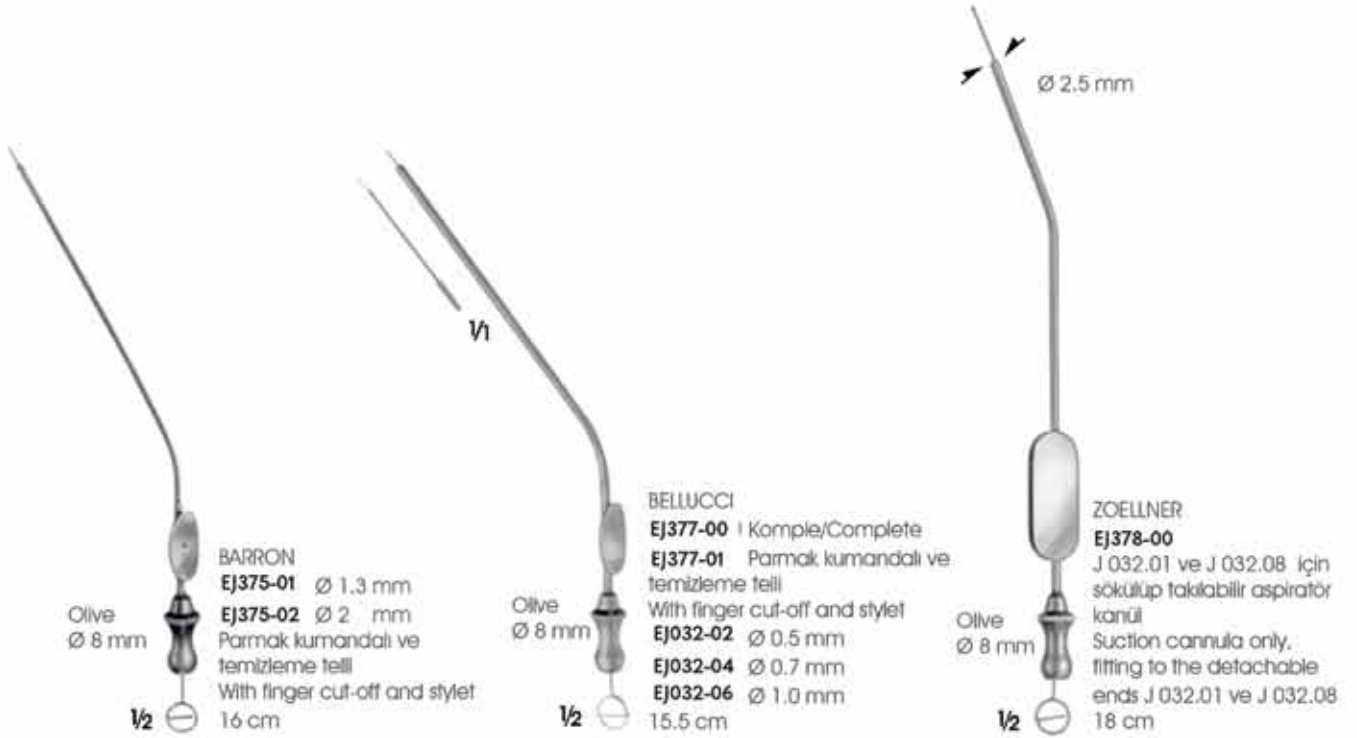

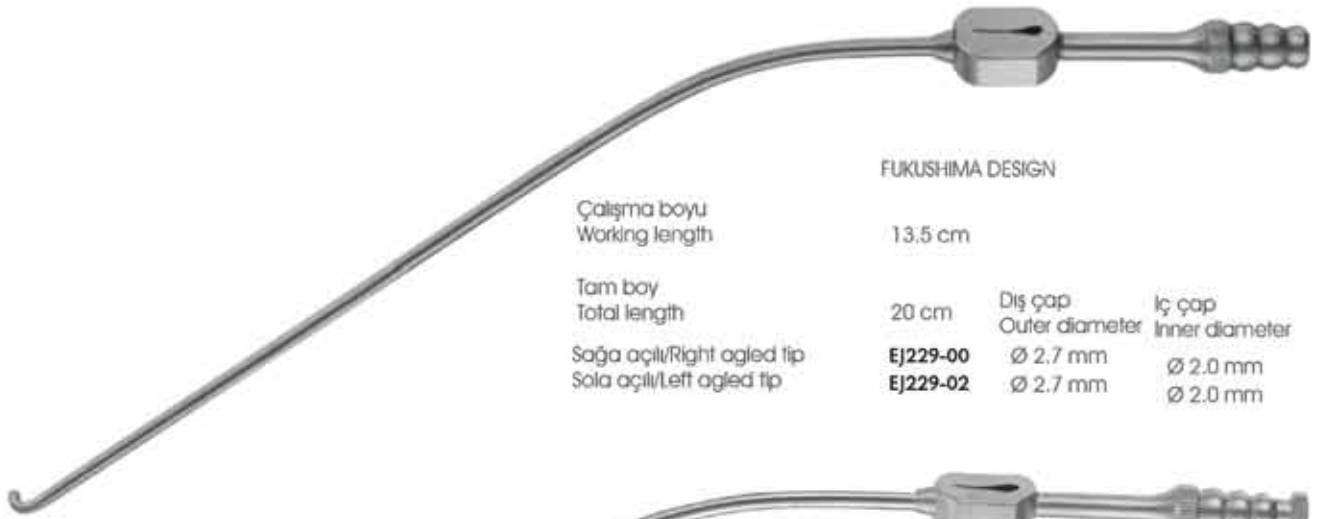

Çalışma boyu
Working length

FUKUSHIMA DESIGN

13.5 cm

Tam boy
Total length

20 cm

Diş çapı
Outer diameter

İç çapı
Inner diameter

Sağa açılı/Right angled tip
Sola açılı/Left angled tip

EJ229-00

Ø 2.7 mm

Ø 2.0 mm

EJ229-02

Ø 2.7 mm

Ø 2.0 mm

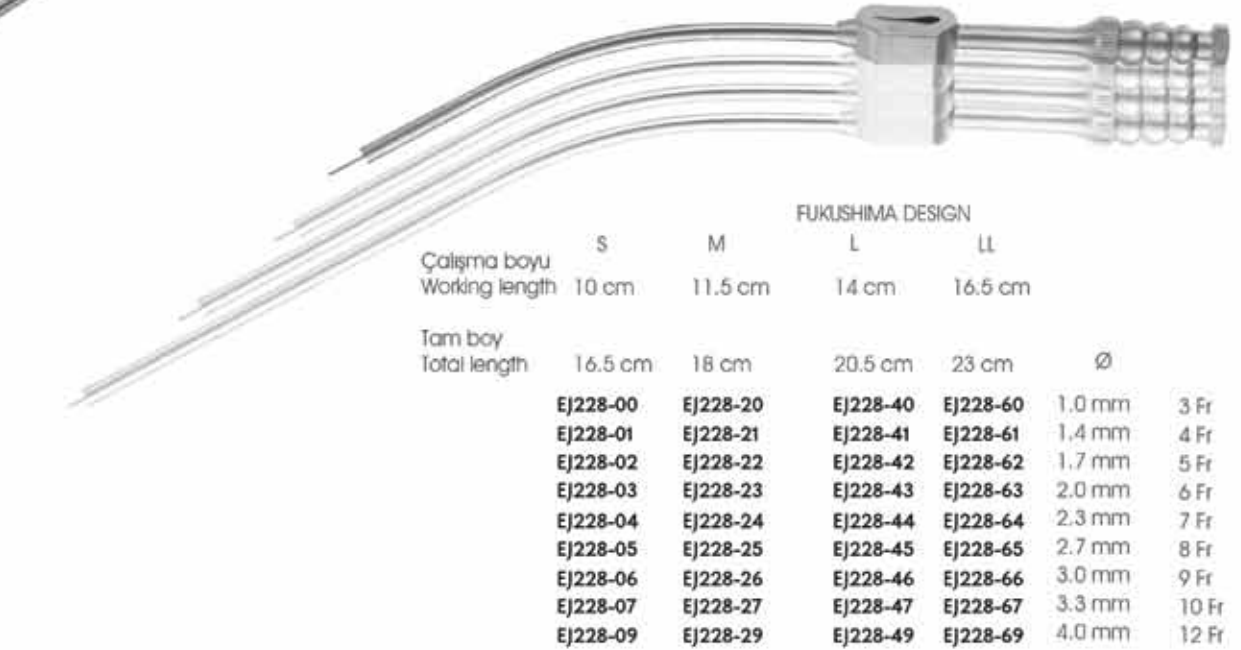

Çalışma boyu
Working length

FUKUSHIMA DESIGN

Tam boy
Total length

S

M

L

LL

10 cm

11.5 cm

14 cm

16.5 cm

16.5 cm

18 cm

20.5 cm

23 cm

Ø

EJ228-00

EJ228-20

EJ228-40

EJ228-60

1.0 mm

3 Fr

EJ228-01

EJ228-21

EJ228-41

EJ228-61

1.4 mm

4 Fr

EJ228-02

EJ228-22

EJ228-42

EJ228-62

1.7 mm

5 Fr

EJ228-03

EJ228-23

EJ228-43

EJ228-63

2.0 mm

6 Fr

EJ228-04

EJ228-24

EJ228-44

EJ228-64

2.3 mm

7 Fr

EJ228-05

EJ228-25

EJ228-45

EJ228-65

2.7 mm

8 Fr

EJ228-06

EJ228-26

EJ228-46

EJ228-66

3.0 mm

9 Fr

EJ228-07

EJ228-27

EJ228-47

EJ228-67

3.3 mm

10 Fr

EJ228-09

EJ228-29

EJ228-49

EJ228-69

4.0 mm

12 Fr

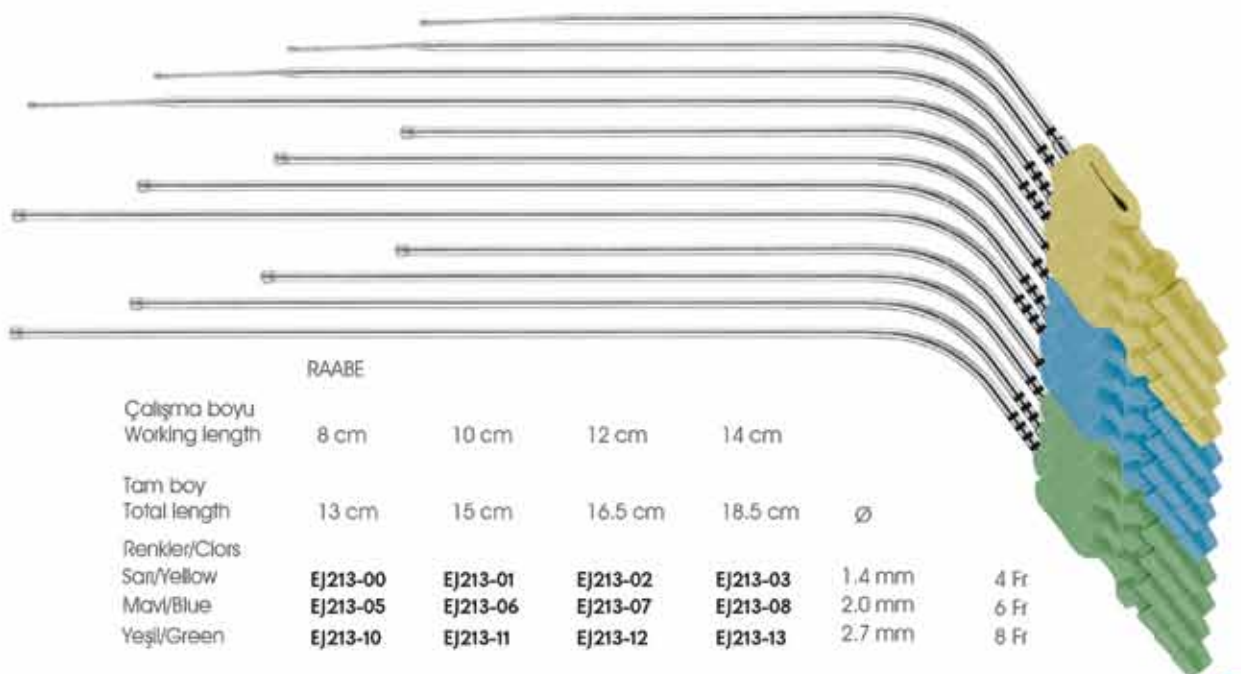

RAABE

Çalışma boyu
Working length

8 cm

10 cm

12 cm

14 cm

Tam boy
Total length

13 cm

15 cm

16.5 cm

18.5 cm

Ø

Renkler/Colors

Sarı/Yellow

EJ213-00

EJ213-01

EJ213-02

EJ213-03

1.4 mm

4 Fr

Mavi/Blue

EJ213-05

EJ213-06

EJ213-07

EJ213-08

2.0 mm

6 Fr

Yeşil/Green

EJ213-10

EJ213-11

EJ213-12

EJ213-13

2.7 mm

8 Fr

EJ604-00

Parmak kumandalı ve temizleme telli
With finger cut-off and stylet

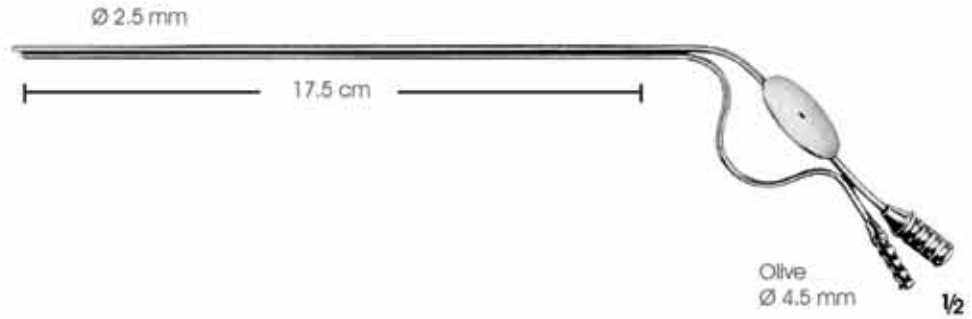

EJ265-00 Ø 2.0 mm

EJ265-01 Ø 2.5 mm

EJ265-02 Ø 3.0 mm

Parmak kumandalı ve temizleme telli
parmak basma yüzeyi yatay
With finger cut-off, thumb piece 90° to curve
25 cm



HOUSE

EJ608-00 Ø 0.9 - 0.7 mm

EJ608-01 Ø 1.2 - 0.9 mm

EJ608-02 Ø 1.5 - 1.2 mm

Parmak kumandalı ve temizleme telli
With finger cut-off and stylet

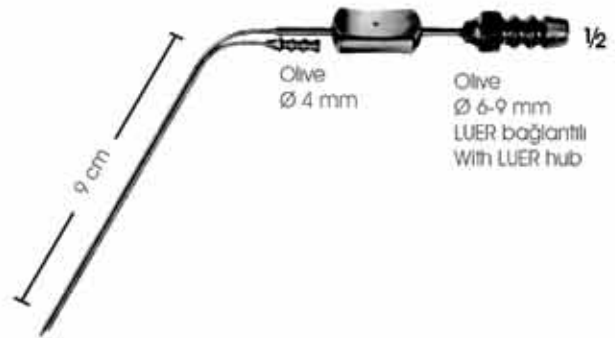

EJ360-00 4 mm

EJ360-01 5 mm

Aspiratör raspa, sivri bayonet tip
Suction raspatories, sharp
bayonet-shaped
20 cm



LANDOLT

EJ361-00 Genişlik/Wide 3.2 mm
Hipofizektomi ve Kbb için aspiratör ucu,
keskin açılı nokta
Dissecting suction tube for hypophysectomie
and ENT, sharp angled point
20 cm



EJ352-00

Uc genişliği 6.5 mm
Tip wide 6.5 mm
Burun aspiratör ucu, LUER bağlantılı
Nasal suction tube, with LUER hub
18 cm



GORNEY

EJ368-00

Aspiratör disektör
Suction dissector
18 cm



NEGUS

EJ367-00

Aspiratör disektör
Suction dissector
21 cm



LOPEZ-REINKE

EJ365-00

Aspirasyonlu Tonsil disektör
Tonsil dissector with suction
device
23.5 cm



YASARGIL

EJ602-00

Kanül/Cannulae
LUER-LOC koniği
LUER-LOC cone
20 cm



YASARGIL

Aspiratör uçları/Suction tubes

EJ260-00 Ø 1.5 mm	EJ260-01 Ø 1.5 mm	EJ260-02 Ø 1.5 mm	EJ260-03 Ø 1.5 mm
EJ260-04 Ø 2.0 mm	EJ260-05 Ø 2.0 mm	EJ260-06 Ø 2.0 mm	EJ260-07 Ø 2.0 mm
EJ260-08 Ø 2.5 mm	EJ260-09 Ø 2.5 mm	EJ260-10 Ø 2.5 mm	EJ260-11 Ø 2.5 mm
EJ260-12 Ø 3.5 mm	EJ260-13 Ø 3.5 mm	EJ260-14 Ø 3.5 mm	EJ260-15 Ø 3.5 mm
13 cm	15 cm	EJ260-16 Ø 4.5 mm	22 cm
		18 cm	

Olive
Ø 6.5-9 mm

LUER bağlantılı
With LUER hub

Ø 3,5 mm

Ø 2.0 mm

EJ263-00 50 cm

EJ263-01 35 cm

Aspiratör uçları/Suction tubes

Lastik uclu

With rubber tip

Olive
Ø 6-9 mm

LUER bağlantılı
With LUER hub



ROWBOTHAM
EJ423-00
Kanül/Cannulae
29.5 cm



MAGILL
EJ422-01 Ø 3.0 mm
EJ422-02 Ø 3.5 mm
EJ422-03 Ø 4.0 mm
Magill emiş kanülü
Stylet for magill suction tubes
24.5 cm

EJ400-00

Büyük miktarda sıvı temizlemek için
For clearing large quantities of fluid
19 cm

Ø 15 mm



Ø 8 mm

EJ415-00

Delmek için trokar
Trocar, for puncturing
17 cm



EJ418-00

Regülatör ve parmak kumandalı
aspiratör adaptörü
Suction handle, with vacuum regulator
and finger cut-off, brass, mirror-finish
chromium-plated
15 cm



Olive
Ø 8 mm

EJ406-00

Çift eğimli genel cerrahi için
Double curved, for general surgery
23 cm



EJ432-00

Ø 9 mm
Üniversal çift eğimli kanül
Universal cannule, double curved
23 cm



Olive
Ø 9 mm

POOL

EJ436-00

Aspiratör kanülü, vidalanabilir dış tüpü ile
Suction cannulla, with outer tube to be
screwed off
22.5 cm



Olive
Ø 8-10.5 mm

▲
Ø 10 mm
Charr.30

POOL

EJ437-00

Aspiratör kanülü, vidalanabilir dış tüpü ile
Suction cannulla, with outer tube to be
screwed off
22.5 cm



Olive
Ø 6.5-9.5 mm

▲
Ø 7 mm
Charr.21

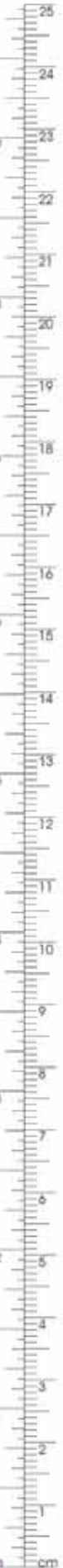

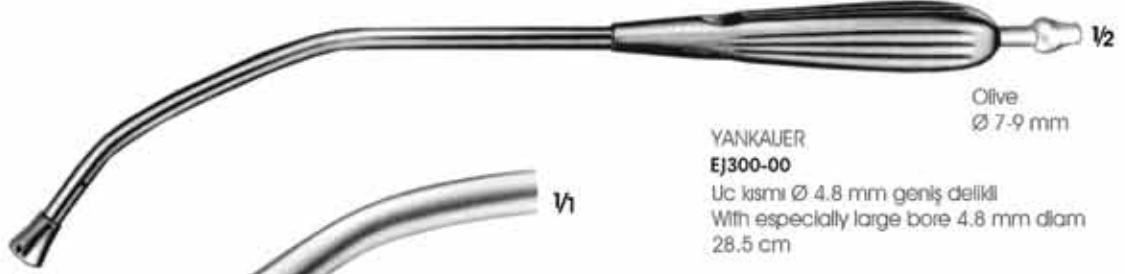

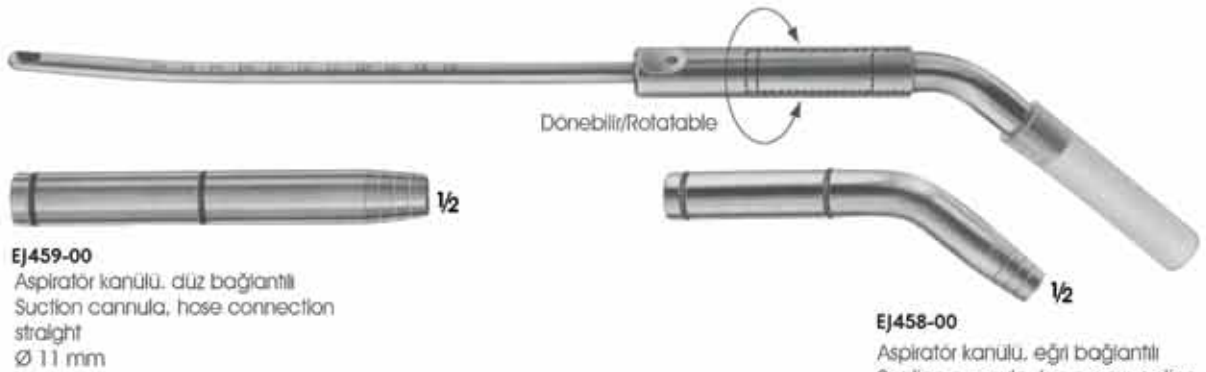
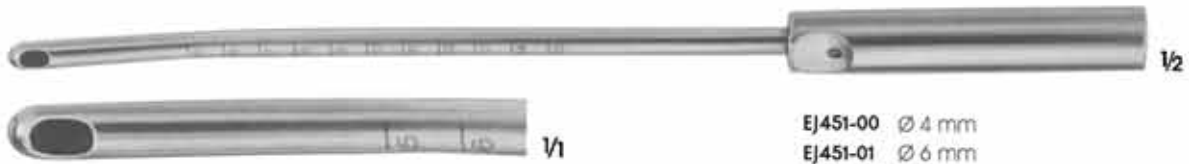

**LANDOLT
EJ620-00** İzoleli/Insulated
Pıhtı emiş kanülü, mandrenli ve stoplu Ø 5 mm
143° buhar sterilizatörlerinde steril edilebilir.
Coagulation suction cannula
with interrupter and mandrel Ø 5 mm
Can be sterilized in a steam sterilizer up to 143°





EJ102-00
4 ucu ile birlikte
sökülebilir trokar
Trocar with interchangeable
tips (4 pcs.)

1/2
PIERCE
EJ108-00 Ø 4.0 mm
Antrum trokar
Antrum trocar

1/2
KRAUSE
EJ110-00 1 Ø 4.0 mm
Antrum trokar
Antrum trocar

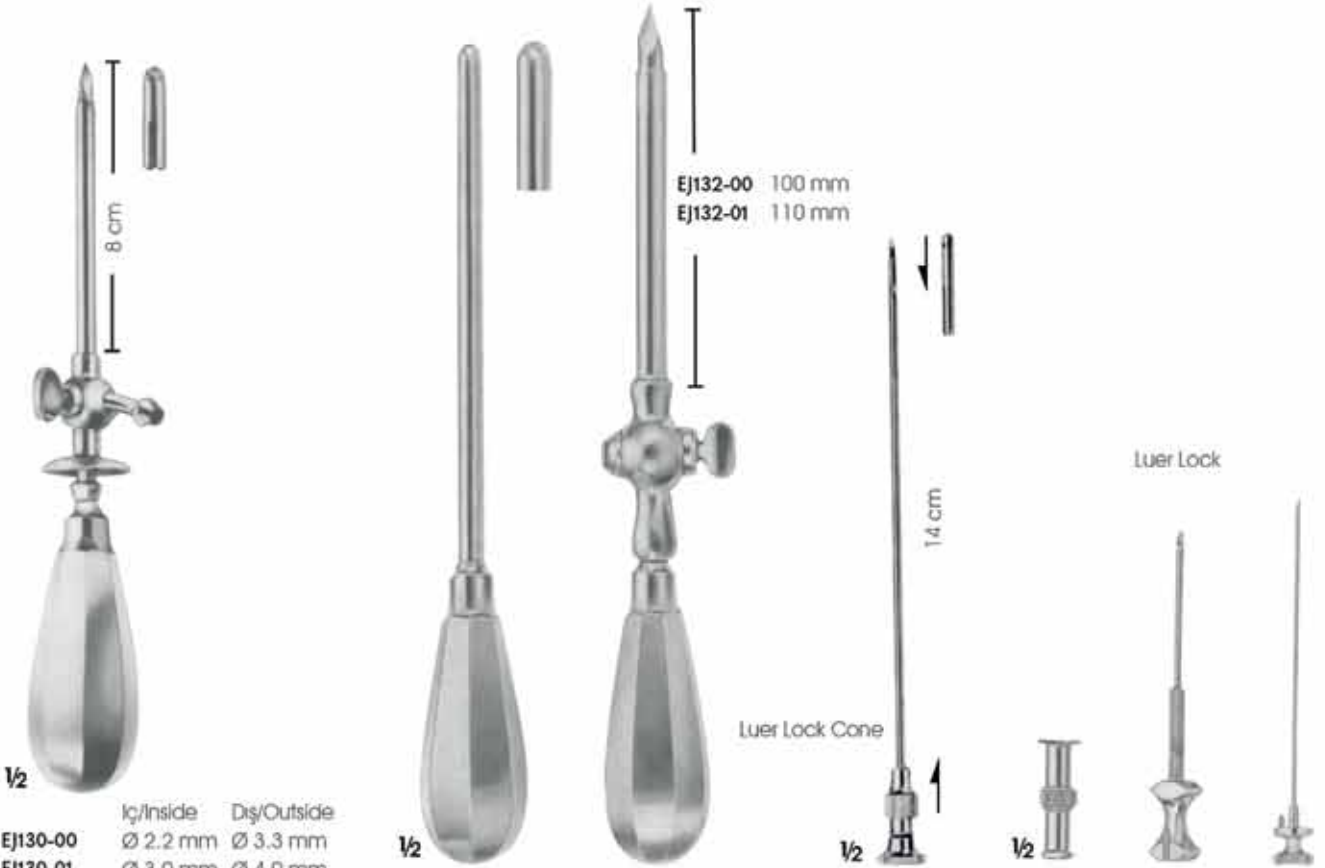

1/2
İç/Inside Diş/Outside
EJ130-00 Ø 2.2 mm Ø 3.3 mm
EJ130-01 Ø 3.0 mm Ø 4.0 mm
EJ130-02 Ø 4.0 mm Ø 5.0 mm
EJ130-03 Ø 5.0 mm Ø 6.0 mm
Yandan boşaltmalı musluklu, kanın
delme trokar
For abdominal puncture, with
stop-cock and lateral drain.

1/2
BÜELAU
İç/Inside Diş/Outside
EJ132-00 Ø 6.5 mm Ø 8.0 mm
EJ132-01 Ø 9.0 mm Ø 10.0 mm
Ampiyem trokar
Empyema trocar

1/2
LANDAU
EJ138-00
Ø 2 mm
Pelvik apse trokar
Pelvic abscess trocar

Luer Lock
1/2
KLIMA-ROSEGGER
EJ706-00 35 x 1.8 mm
Göğüs kemiği delici iğne
Sternal puncture needle



Charr.
EF800-00 8
EF800-01 10
EF800-02 12
EF800-03 14
EF800-04 16
EF800-05 18
 Arkası tırtilli, bıçak tip, hafif eğri
 With thread, knife tip, slightly curved
 19 cm

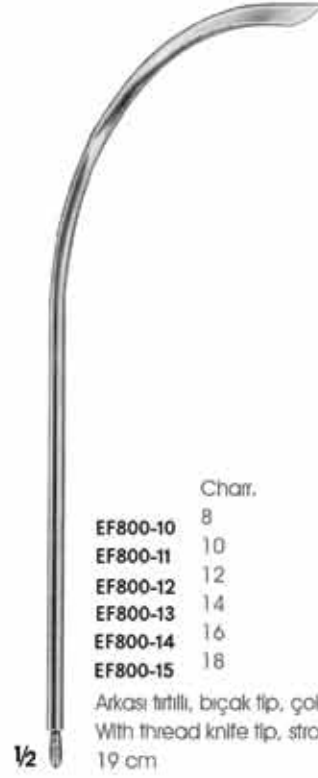

Charr.
EF800-10 8
EF800-11 10
EF800-12 12
EF800-13 14
EF800-14 16
EF800-15 18
 Arkası tırtilli, bıçak tip, çok eğri
 With thread knife tip, strongly curved
 19 cm



Charr.
EF800-20 8
EF800-21 10
EF800-22 12
EF800-23 14
EF800-24 16
EF800-25 18
 Arkası tırtilli, bistürlü tip, hafif eğri
 With thread, lancet tip, slightly curved
 19 cm



Charr.
EF800-30 8
EF800-31 10
EF800-32 12
EF800-33 14
EF800-34 16
EF800-35 18
 Arkası tırtilli, trokar tip, hafif eğri
 With thread, trocar tip, slightly curved
 19 cm

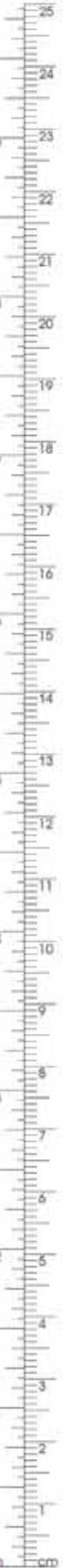

EK

El Ekartörleri, Huklar ve Spatulalar
Retractors, Hooks and Spatulas



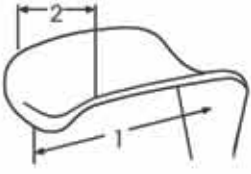

Ekartörler için ölçü sistemi

Derinlik :1
Genişlik :2

Örnek:1 x 2

Measurement system for retractor blades

Depth:1
Width :2

Example:1 x 2

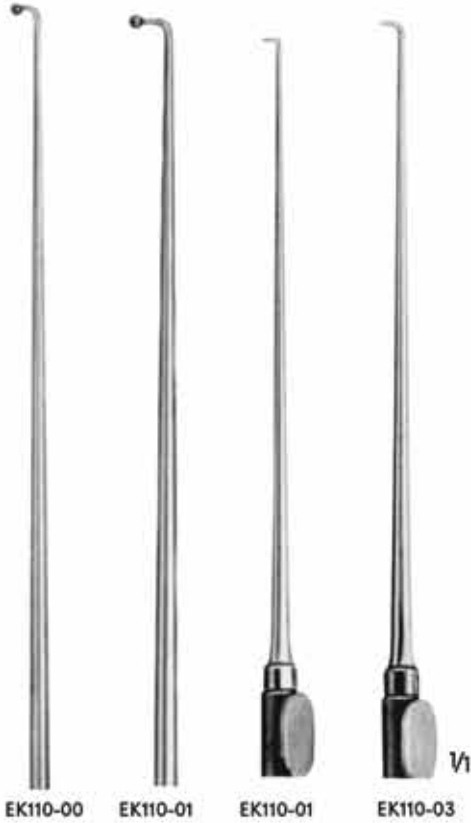

EK110-00

EK110-01

EK110-01

EK110-03

1/2

KRAYENBÜLH
EK110-00-EK110-03
18,5 cm

1/2

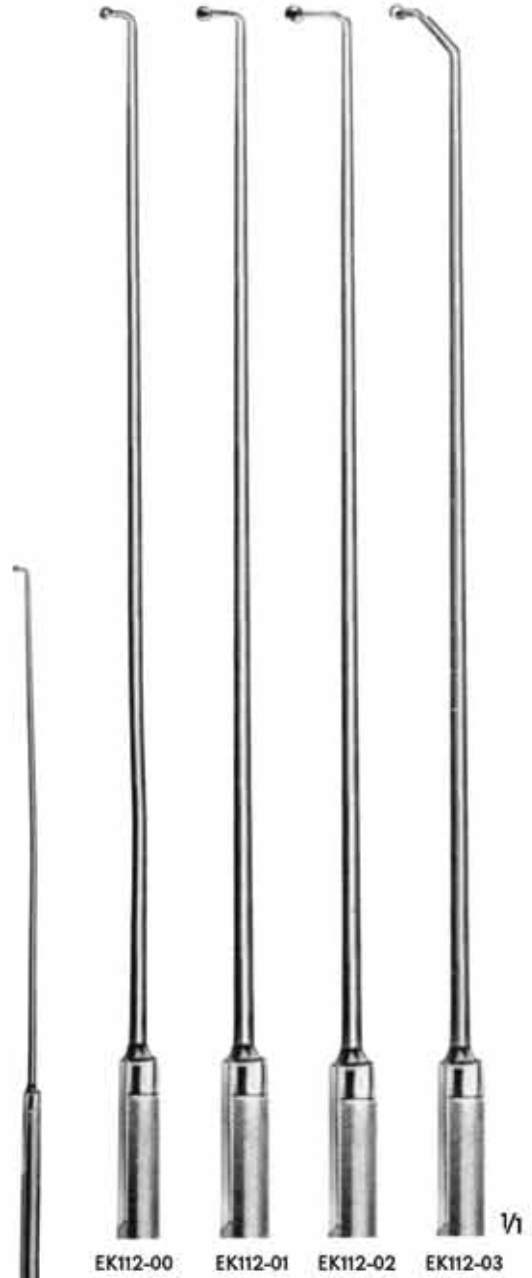

EK112-00

EK112-01

EK112-02

EK112-03

1/2

CASPAR
EK112-00-EK112-03
Keşif prob uçlu, huklar
Exploration hooks, probe-ended
24,5 cm

1/2

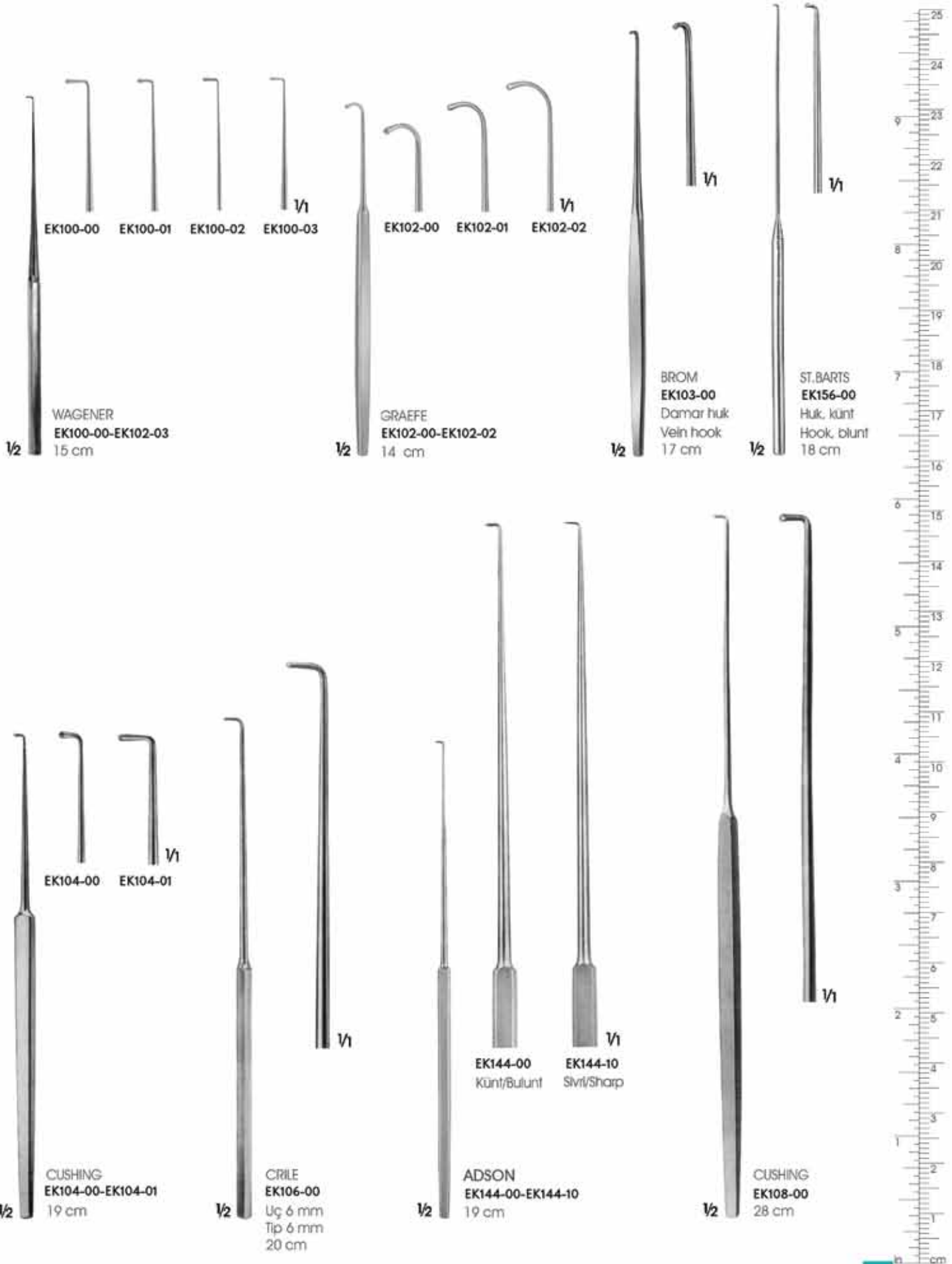



CAIRNS
EK117-00
 Dura ekartör
 Dura retractor
 13 cm

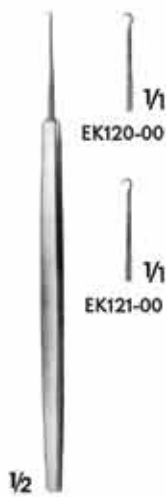

GRAFE
EK120-00 Sivri/Sharp
EK121-00 Kunt/Blunt
 12.5 cm



FRAZIER
EK122-00
 Dura ekartör
 Dura retractor
 13 cm



GUTHRIE
EK123-00 12.5 cm
EK123-01 13 cm
 Sivri/Sharp

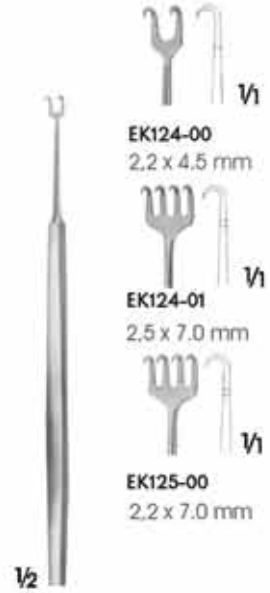

ROLLET
EK124-00 13 cm
EK124-01 13.5 cm
 Sivri/Sharp
EK125-00 13.5 cm
 Kunt/Blunt



MÜLLER
EK130-00
 15 cm



KILNER
EK127-00
 16 cm



FREER
EK128-00
 15 cm



MÜLLER
EK131-00
 15 cm



COTTLE
EK133-00
 16 cm



JÄGER
EK136-00
13.5 cm



TÖNNIS
EK137-00
Dura ekartör
Dura retractor
15 cm



COTTLE
EK134-00
16 cm



GILLIES
EK138-00-EK138-01
18 cm

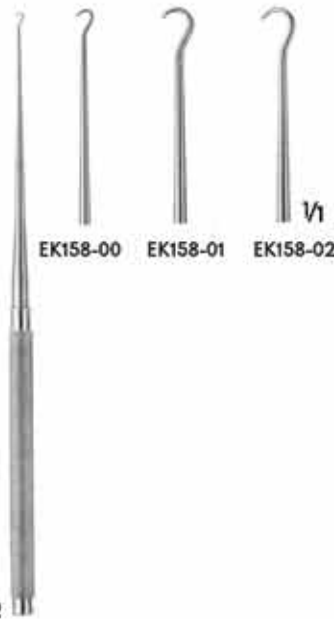

KLEINERT-KUTZ
EK158-00-EK158-02
16 cm

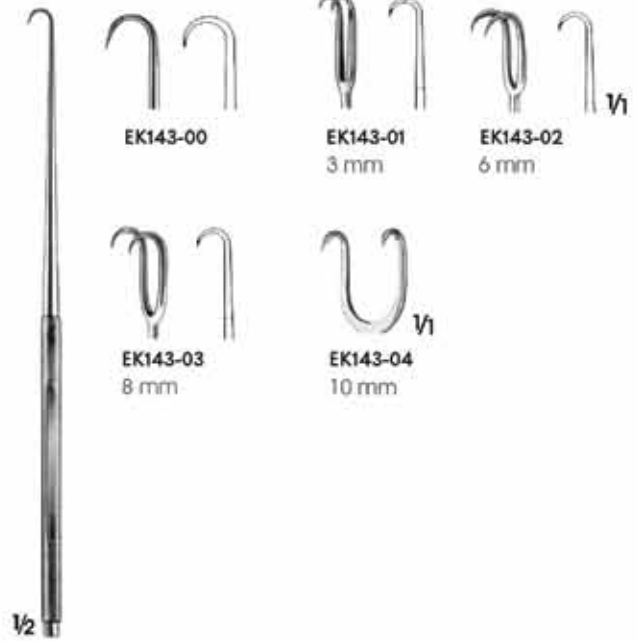

JOSEPH
EK143-00-EK143-04
16.5 cm



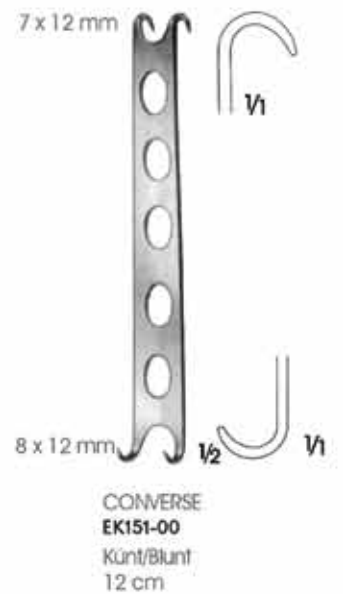
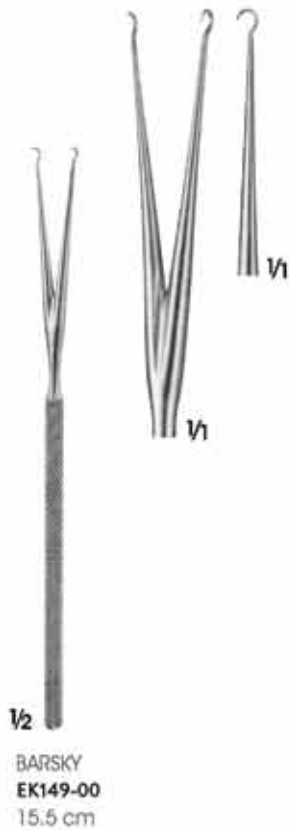

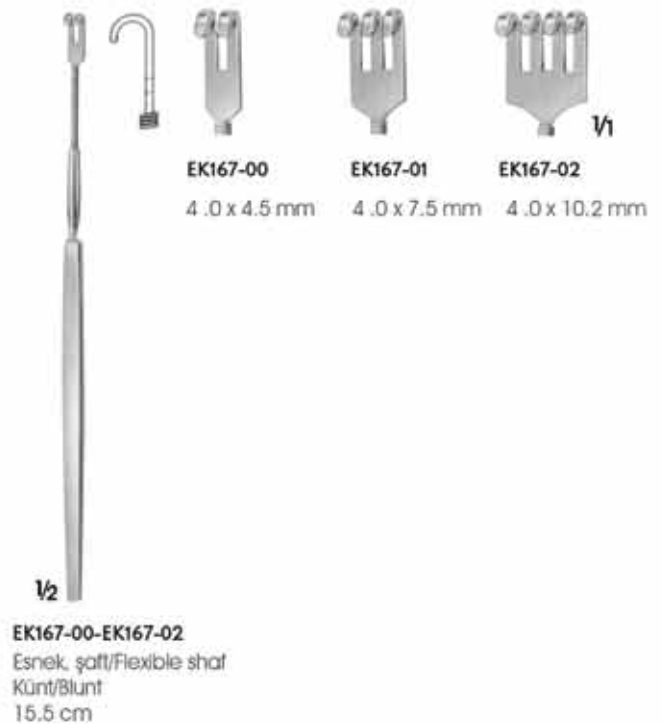
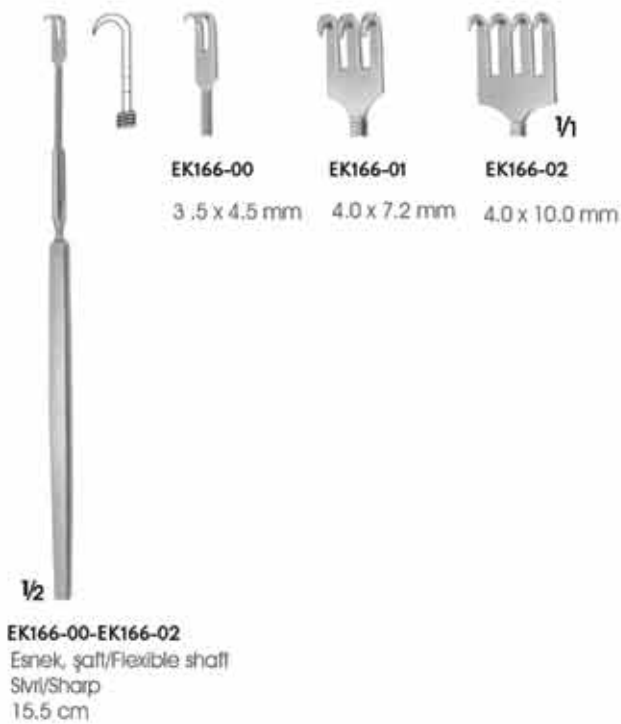

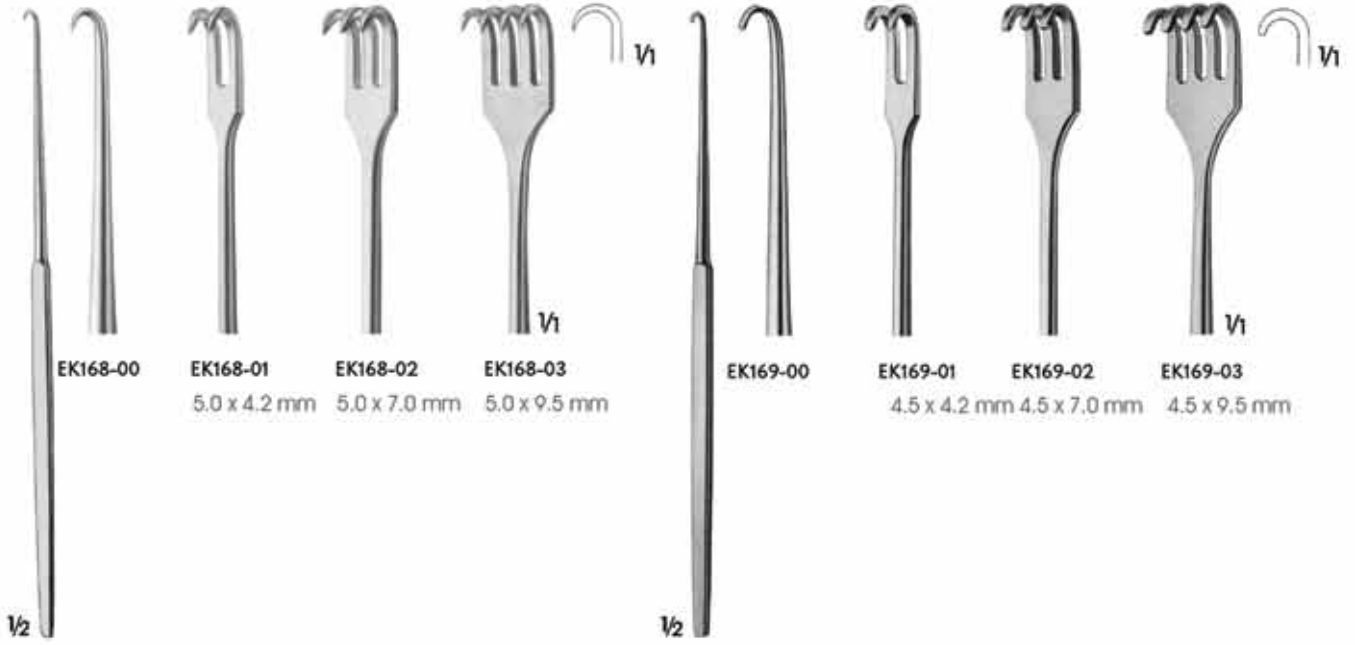

EK168-00-EK168-03 Sivri/Sharp
Küçük eğri/Small curve
16.5 cm

EK169-00-EK169-03 Künt/Blunt
Küçük eğri/Small curve
16.5 cm

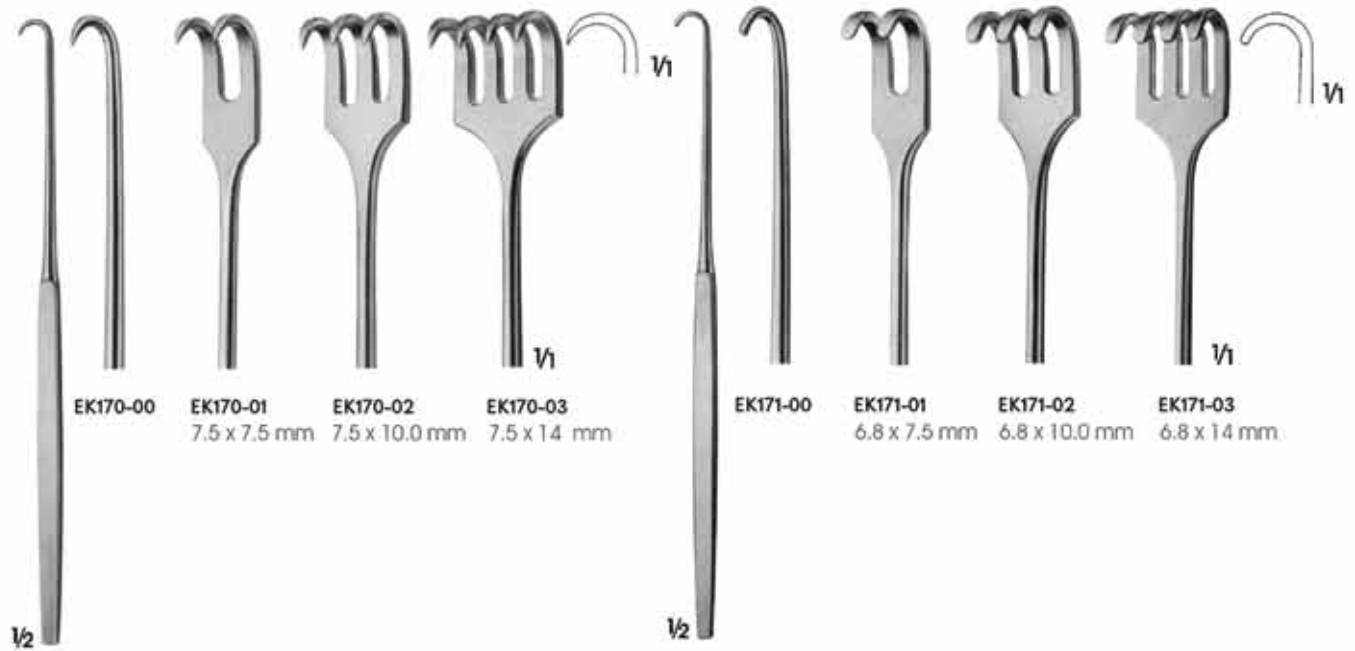

EK170-00-EK170-03 Sivri/Sharp
Büyük eğri/Large curve
16.5 cm

EK171-00-EK171-03 Künt/Blunt
Büyük eğri/Large curve
16.5 cm



MANNERFELT
EK175-00
Sivri/Sharp
13.5 cm



MANNERFELT
EK176-00
Sivri/Sharp
15.5 cm



MANNERFELT
EK177-00
Sivri/Sharp
15.5 cm



MANNERFELT
EK178-00
Esnek shaft küçük eğri, sivri
Flexible shaft, small curve, sharp
15.5 cm

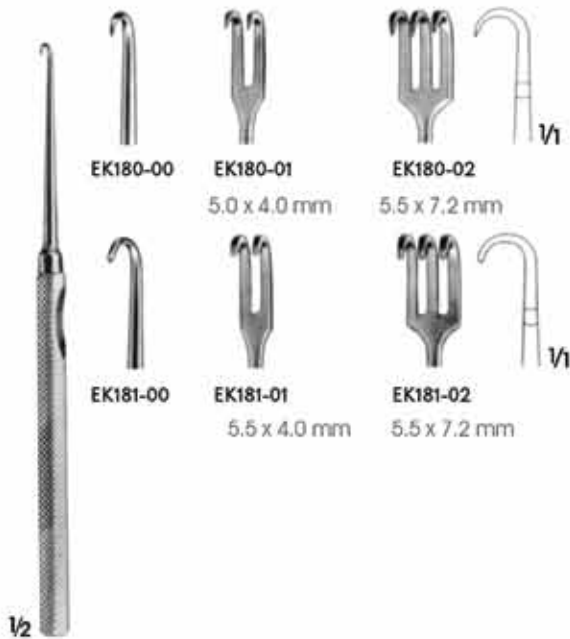

MANNERFELT
EK180-00-EK180-02 Sivri/Sharp
EK181-00-EK181-02 Künt/Blunt
Küçük eğri/Small curve
15.5 cm

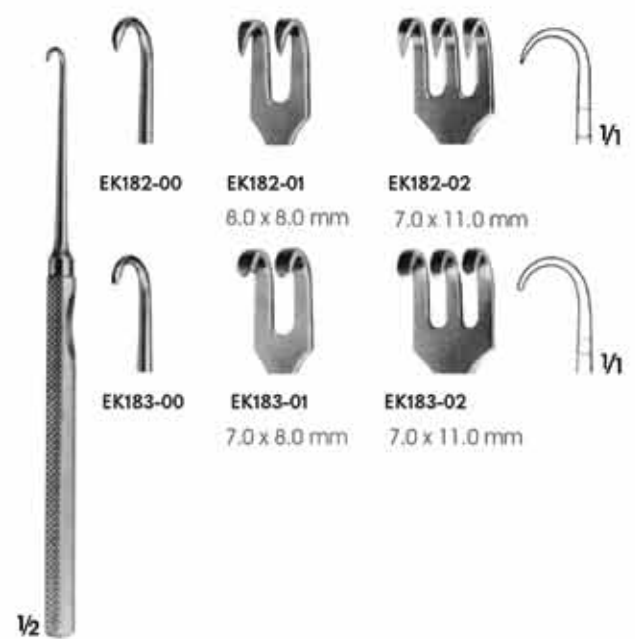

MANNERFELT
EK182-00-EK182-02 Sivri/Sharp
EK183-00-EK183-02 Künt/Blunt
Büyük eğri/Large curve
15.5 cm





MANNERFELT
EK190-00
Oluklu/Hollow grooved
15.5 cm

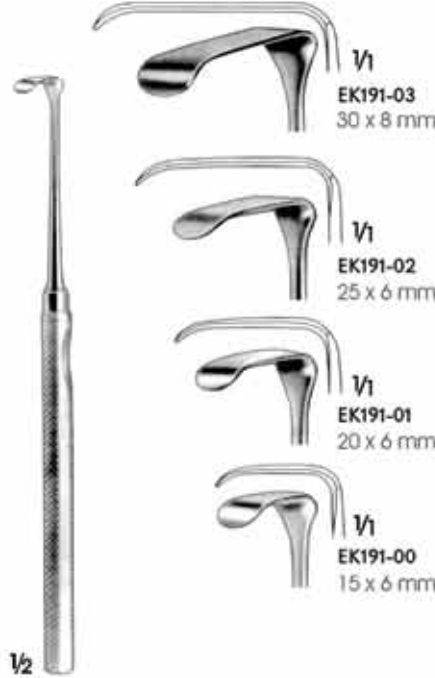

LANGENBECK-MANNERFELT
EK191-00-EK191-03
15.5 cm



MANNERFELT
EK195-00-EK195-02
Eyer hukları/Saddle hooks
15.5 cm

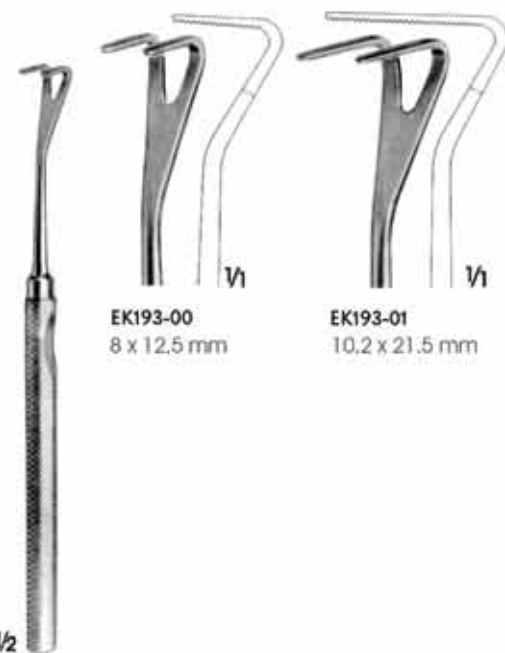

MANNERFELT
EK193-00-EK193-01
Geri eğimli çatallı huk
Forked hooks, retrograded
curved
15.5 cm



MANNERFELT
EK196-00
Eyer huk, çerçeveli
Saddle hook, fenestrated
15.5 cm



MANNERFELT
EK198-00
Tendon çift uçlu huk
Tendon double hook
16 cm



EK200-00-EK200-01
Sivri/Sharp
16 cm



LANGENBECK-GREEN
EK202-00-EK202-01
16 cm



EK203-00
16 cm



STRANDELL-STILLE
EK205-00-EK206-00
Tendon Hukları/Tendon Hooks
18 cm



FOMON
EK210-00
Kunt/Blunt
14.5 cm



COTILE
EK212-00
Sağ sivri/Right sharp
14.5 cm



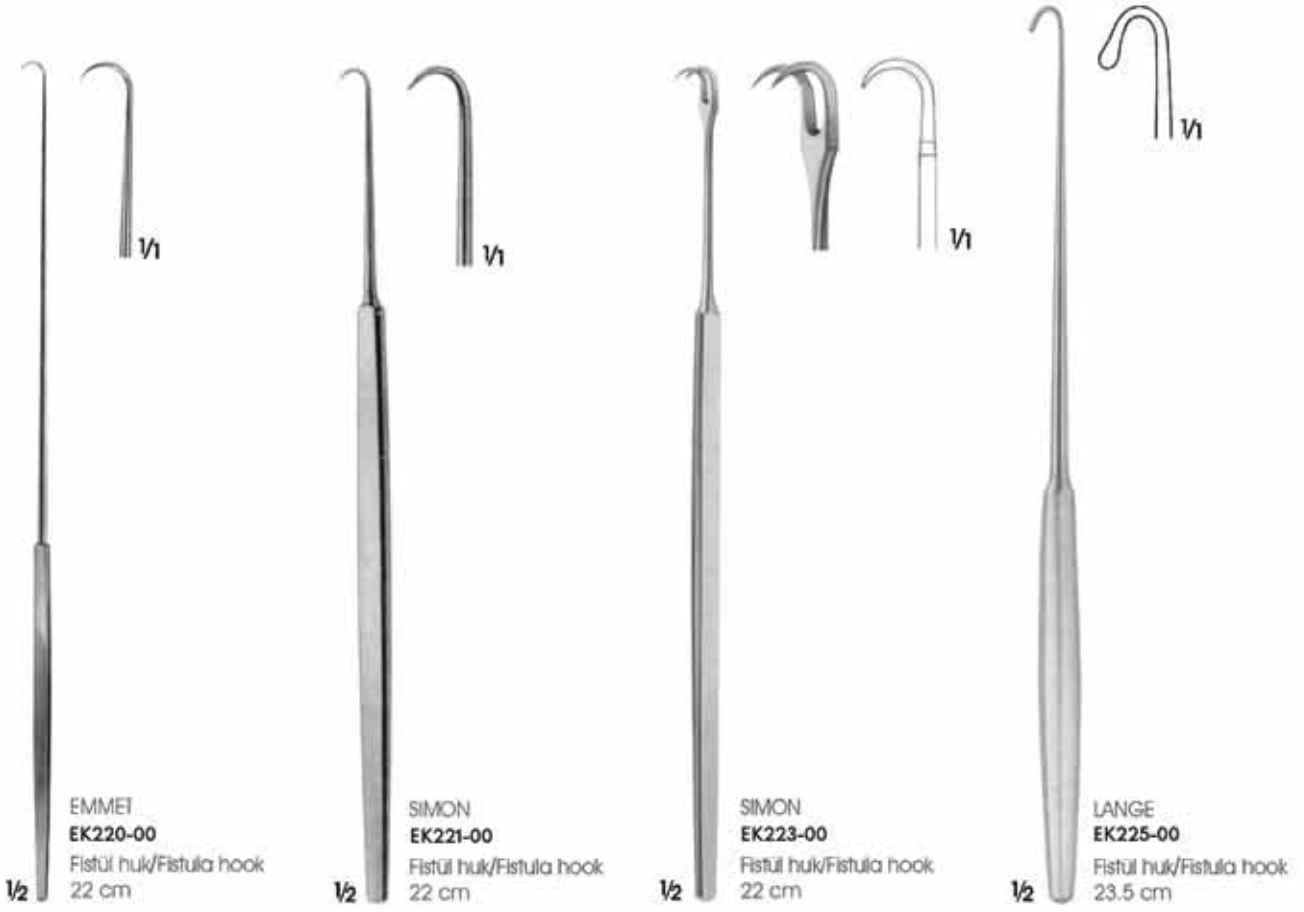

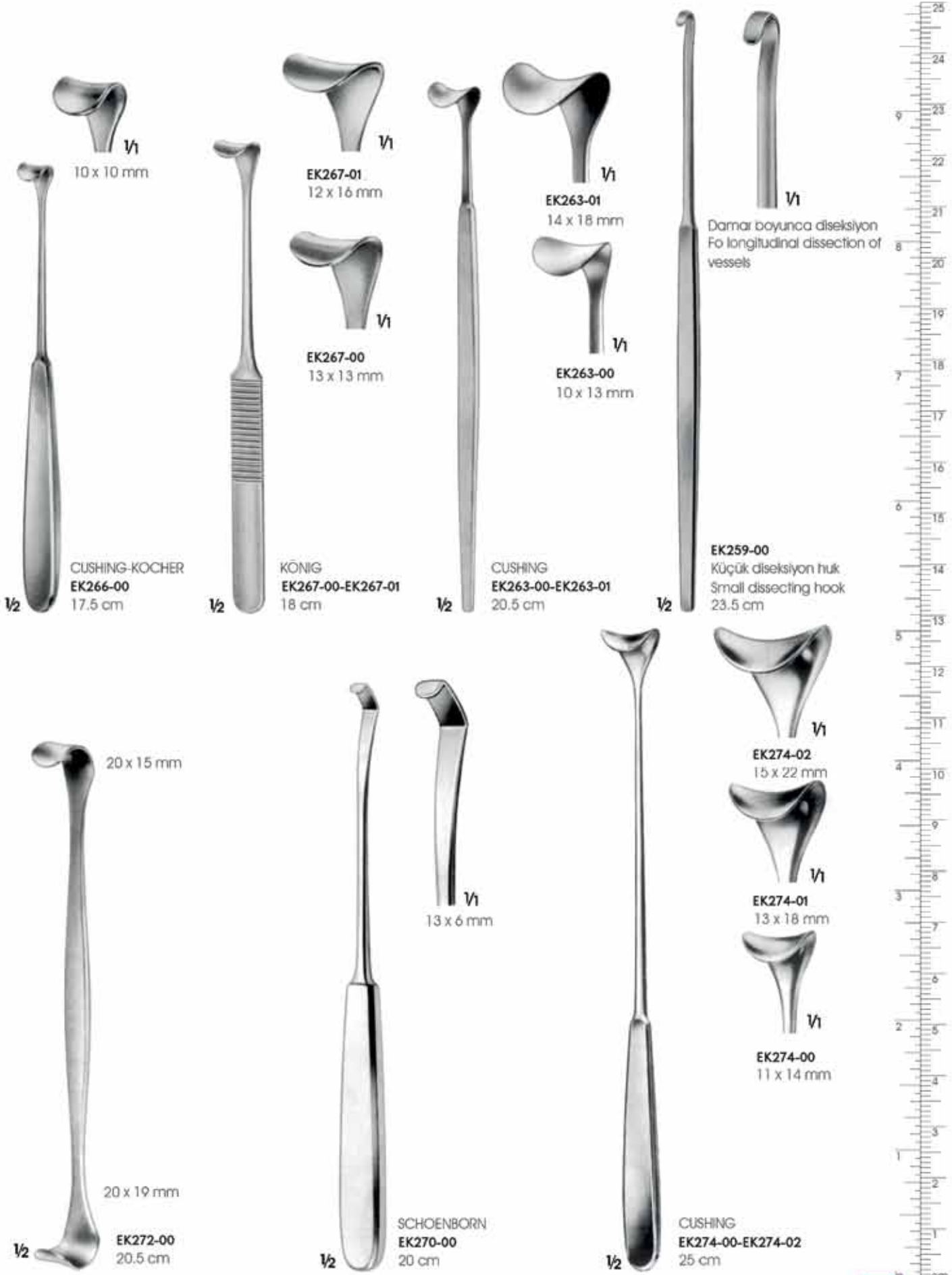



MEYERDING
EK230-00-EK230-05
18 cm



EK230-02
18 x 7 mm



EK230-01
16 x 5 mm



EK230-00
7 x 4 mm



EK230-05
5 x 10 mm



EK230-04
11 x 4 mm



EK230-03
6 x 4 mm

4 x 7 mm



EK238-00



EK238-01

EK238-02



WILLIGER
EK238-00-EK238-02
Sivi/Sharp
12 cm



EK240-00
8 x 7 mm



EK241-00
8 x 7 mm



8 x 7 mm

18 x 5,5 mm



22 x 7 mm

BABY-SENN-MILLER
EK240-00-EK241-00
15.5 cm



SENN-MILLER
EK242-00
16.5 cm



5 x 10 mm

13 x 5 mm



KILNER
EK237-00
15.5 cm



$\frac{1}{2}$
PAUL
EK244-00
Tendon huk/Tendon hook
12 cm



$\frac{1}{2}$
EK246-00-EK246-01
Tendon hukları/Tendon hooks
17.5 cm



$\frac{1}{2}$
KLAPP
EK248-00
Tendon huk/Tendon hook
17.5 cm

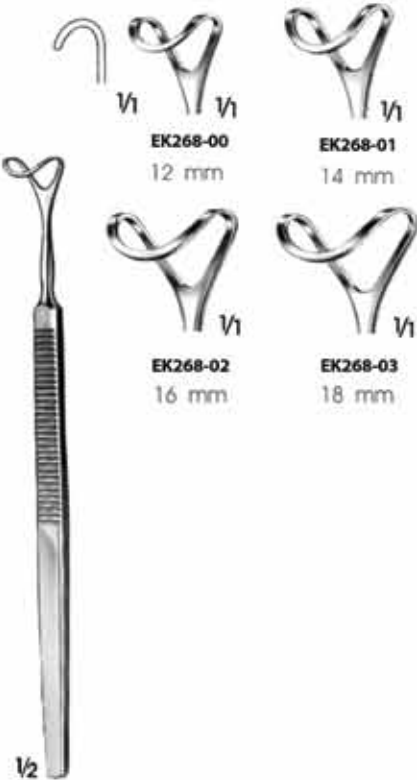

$\frac{1}{2}$
EK268-00-EK268-03
16 cm



$\frac{1}{2}$
EK249-00
Tendon hukları / Tendon hooks
22 cm



$\frac{1}{2}$
KOCHER
EK276-00-EK276-01
20.5 cm



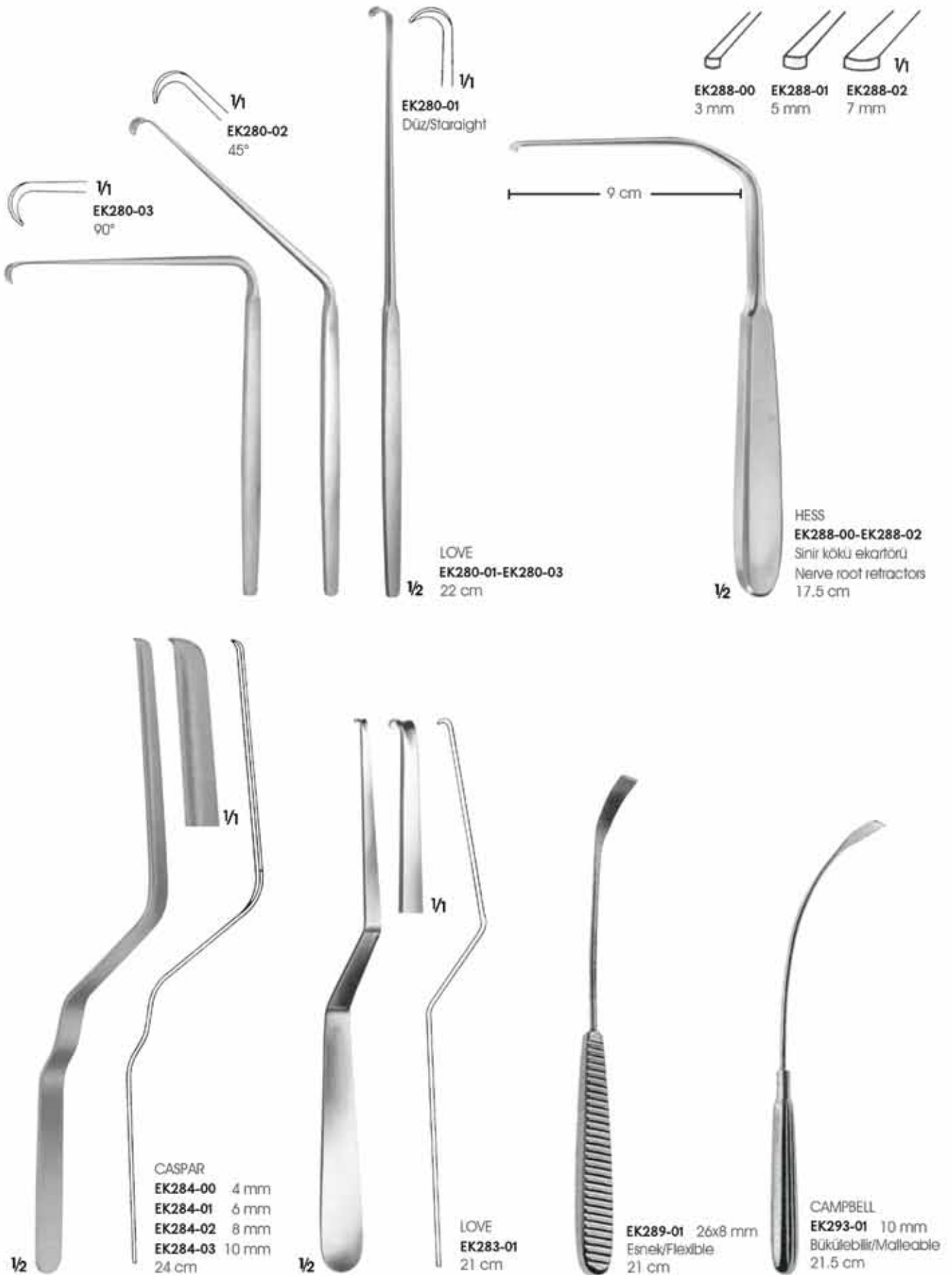

11 x 4 mm

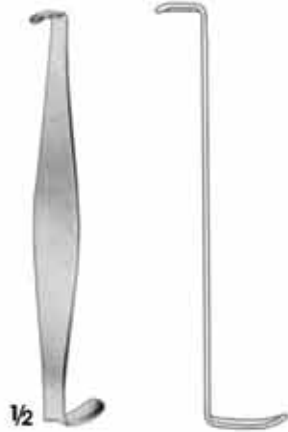

1/2
19 x 6 mm
CRILE
EK300-00
11 cm

10 x 8 mm



1/2
12 x 11 mm
LUER
EK301-00
11 cm

10 x 12 mm



1/2
11 x 15 mm
ROSE
EK302-00
13 cm

5 x 3 mm



1/2
14 x 6.3 mm
RAGNELL
EK304-00
15 cm

25 x 10 mm
22 x 10 mm



1/2
28 x 12 mm
32 x 12 mm
FARABEUF
EK310-00
12.5 cm

23 x 16 mm
20 x 16 mm



1/2
24 x 16 mm
28 x 16 mm
FARABEUF
EK311-00
15 cm

21 x 14 mm
17 x 14 mm



1/2
28 x 16 mm
32 x 16 mm
COLLIN
EK312-00
15 cm

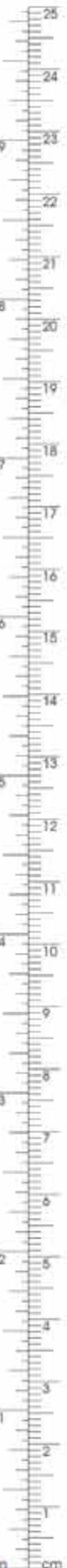

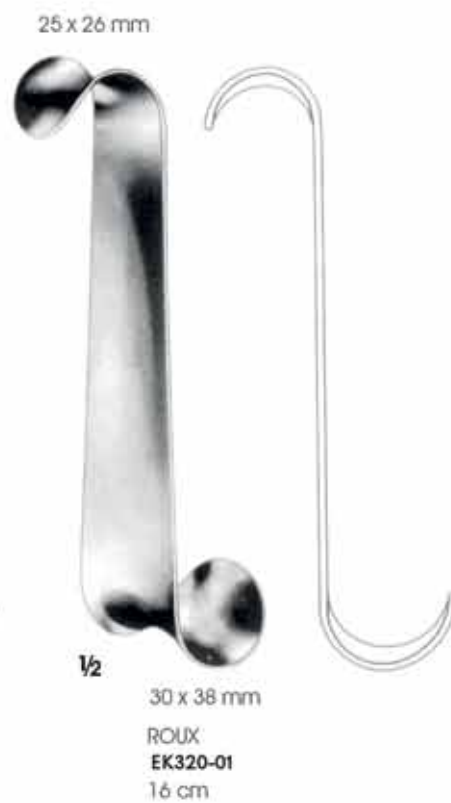

30 x 19 mm



33 x 25 mm
KILNER
EK322-01
15 cm

35 x 29 mm



40 x 35 mm
KILNER
EK333-00
15 cm



GOELET
EK332-00
19 cm



ROUX
EK325-00
Komple/Complete
EK325-01-EK325-03
16.5 cm

21 x 22 mm



27 x 28 mm
EK325-01
14.5 cm

26 x 26 mm



32 x 36 mm
EK325-02
15.5 cm

28 x 29 mm



33 x 45 mm
EK325-03
16.5 cm



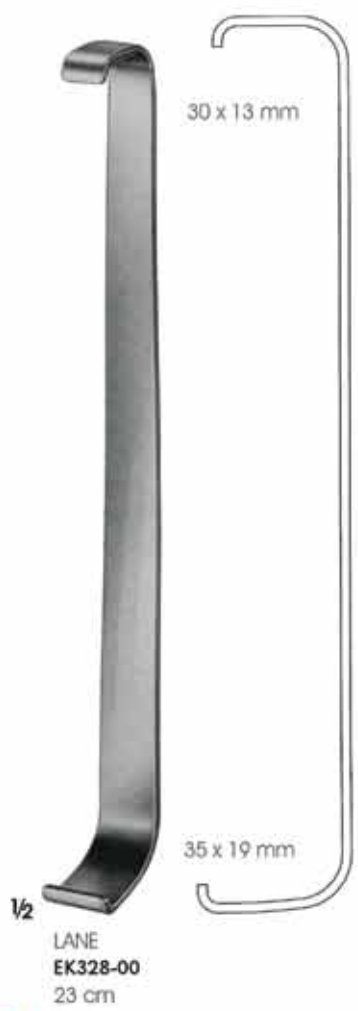
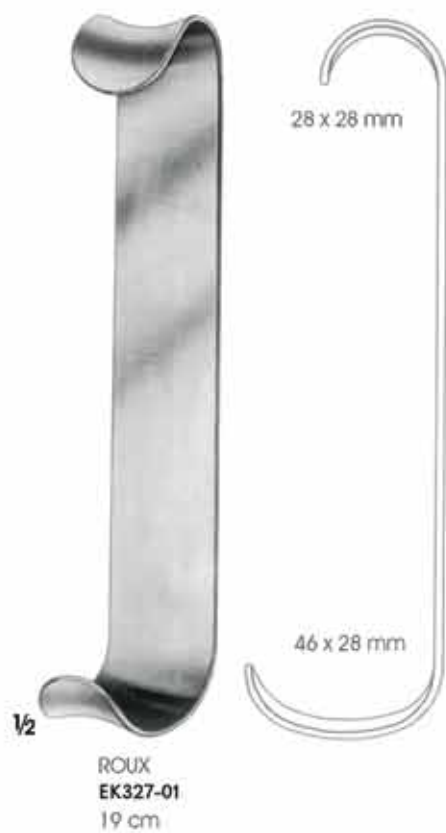
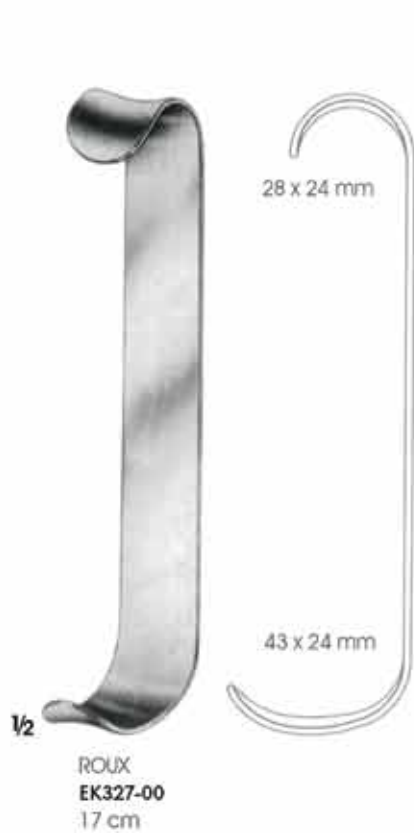

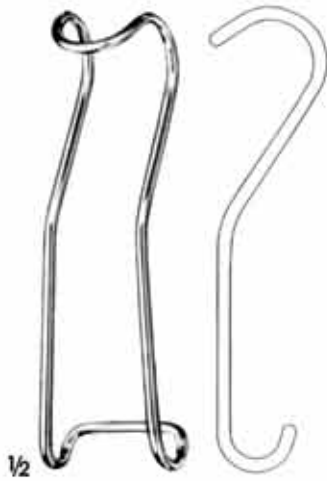

1/2

STERNBERG
EK346-00 12 cm
EK346-01 13 cm
EK346-02 13.5 cm

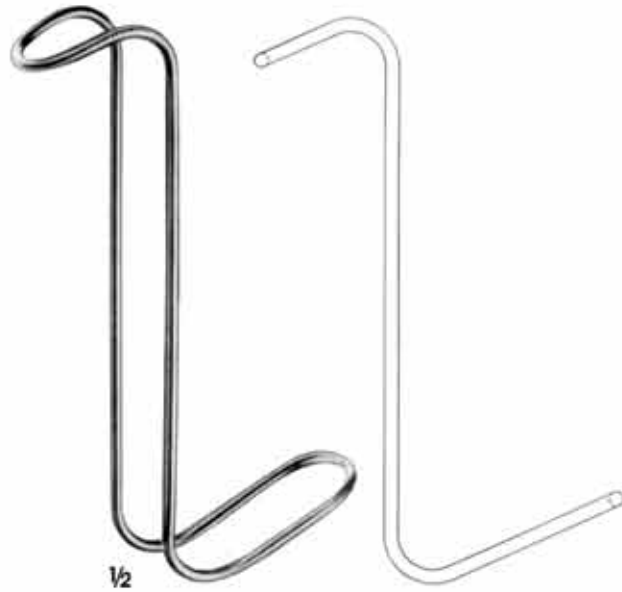

1/2

COLLIN-HARTMANN
EK348-00
15 cm



1/2

CZERNY
EK340-00
17.5 cm



1/2

MATHIEU
EK341-00
20 cm



1/2

US-ARMY
EK342-00
22 cm

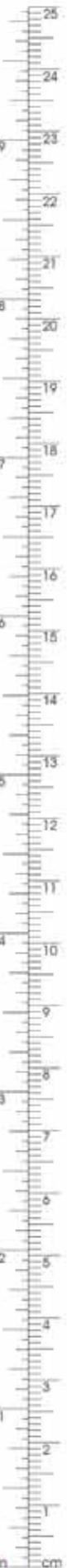





VOLKMANN
EK430-00-EK430-03
EK431-00-EK431-03
22.5 cm



VOLKMANN
EK432-00-EK432-04
EK433-00-EK433-04
EK434-00-EK434-04
22 cm





Yarı sivri
Semi-sharp $\frac{1}{2}$

Künlü
Blunt $\frac{1}{2}$



EK435-00
16 x 9 mm



EK435-01
16 x 14 mm



EK435-02
16 x 20 mm



EK435-03
16 x 30 mm $\frac{1}{2}$



EK436-00
15.5 x 9 mm



EK436-01
15.5 x 14 mm



EK436-02
15.5 x 20 mm



EK436-03
15.5 x 30 mm $\frac{1}{2}$

KOCHER
EK435-00-EK435-03
EK436-00-EK436-03
22 cm $\frac{1}{2}$



26 x 40 mm



EK437-00
8 dişli, yarı sivri
8 prongs, semi-sharp $\frac{1}{2}$

26 x 40 mm



EK438-00
8 dişli, künlü
8 prongs, blunt $\frac{1}{2}$



28 x 40 mm $\frac{1}{2}$

KÖRTE
EK437-00-EK438-00
Dikey saplı bıyık
Handle vertical to the blade
24 cm $\frac{1}{2}$



KÖRTE-WAGNER
EK439-00
8 dişli, yarı sivri
8 prongs, semi sharp
28 cm $\frac{1}{2}$



KÖRTE
EK440-00
4 dişli, künt/4 prongs, blunt
Dikey saplı bıyıld
Handle vertical to the blade
23 cm

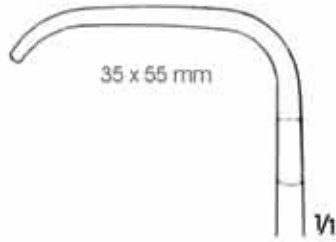

OLLIER
EK442-00
4 dişli, künt
4 prongs, blunt
23 cm



ISRAEL
EK444-00-EK444-03
25.5 cm

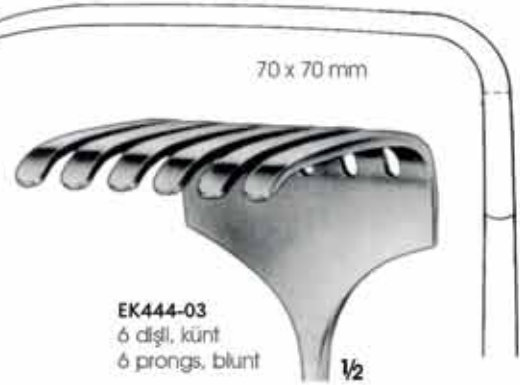

EK444-03
6 dişli, künt
6 prongs, blunt

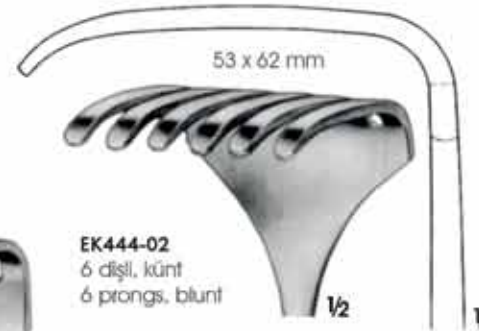

EK444-02
6 dişli, künt
6 prongs, blunt

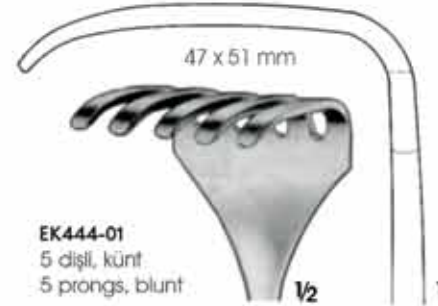

EK444-01
5 dişli, künt
5 prongs, blunt

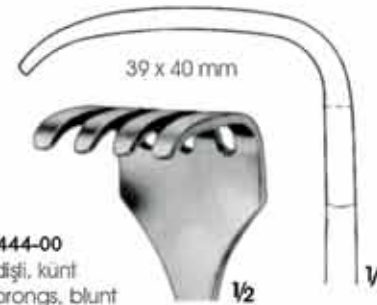

EK444-00
4 dişli, künt
4 prongs, blunt





MURPHY
EK448-00-EK448-11
19.5 cm



EK448-00
Sivri/Sharp



EK448-01
Sivri/Sharp



EK448-10
Künt/Blunt



EK448-11
Künt/Blunt



LANGENBECK
EK450-01-EK450-03
23 cm

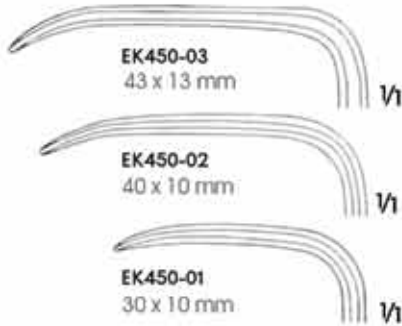

EK450-03
43 x 13 mm

EK450-02
40 x 10 mm

EK450-01
30 x 10 mm



LANGENBECK
EK451-01-EK451-06
21 cm

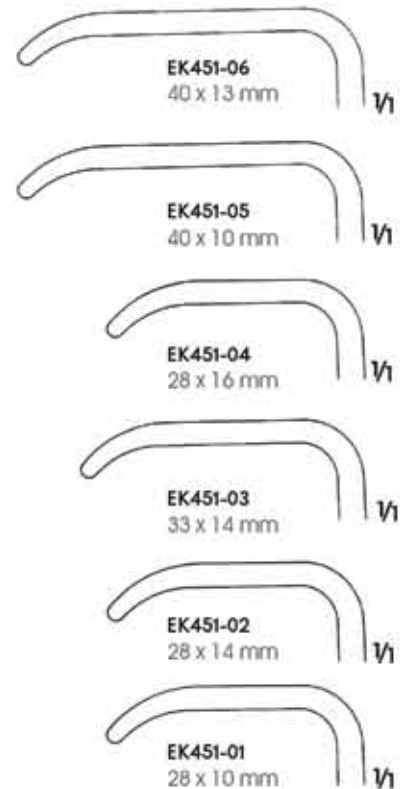

EK451-06
40 x 13 mm

EK451-05
40 x 10 mm

EK451-04
28 x 16 mm

EK451-03
33 x 14 mm

EK451-02
28 x 14 mm

EK451-01
28 x 10 mm



KOCHER-LANGENBECK
EK452-01-EK452-10
21.5 cm

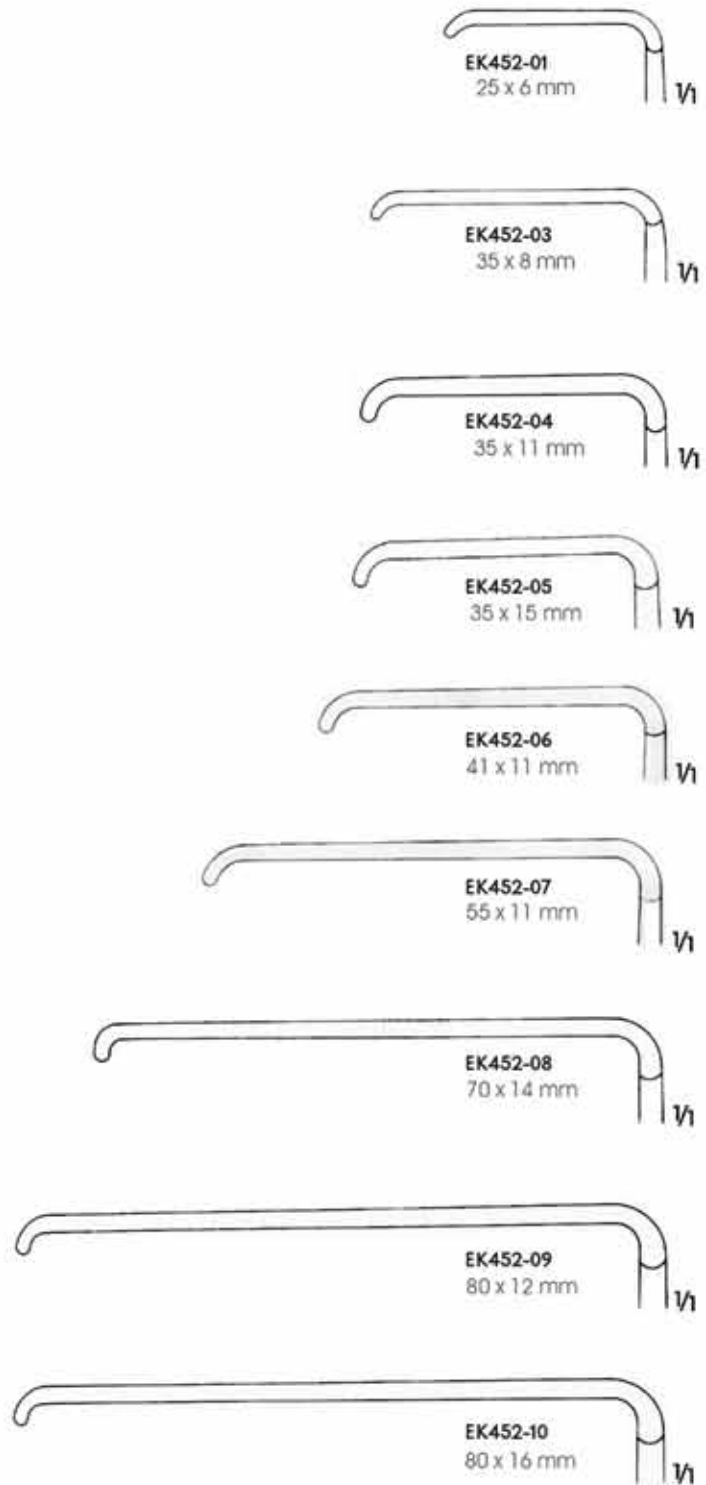

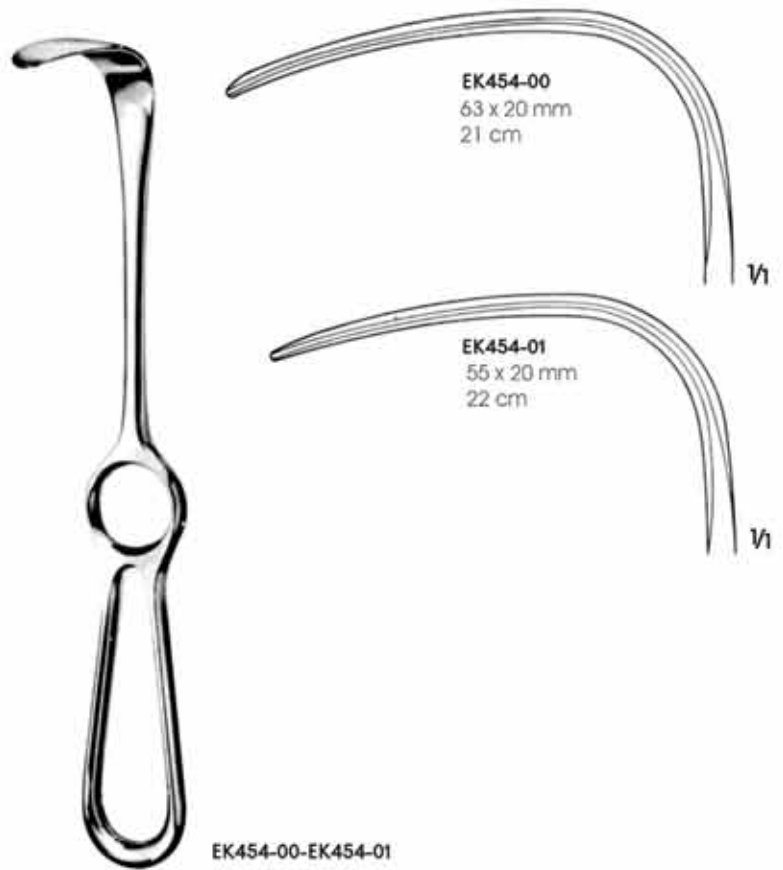



1/2

OBWEGESER
EK457-00-EK457-05
21.5 cm

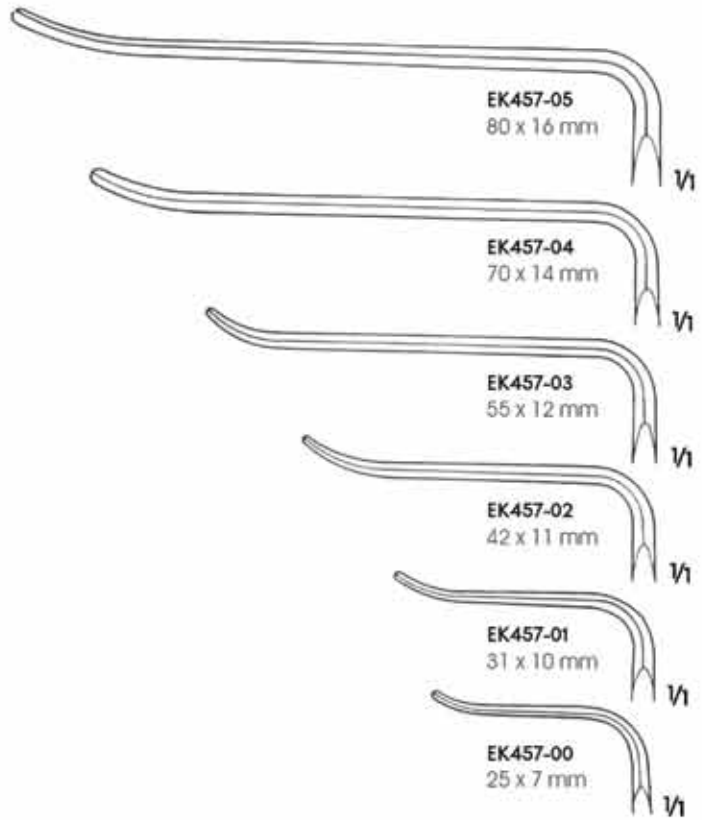

1/2

OBWEGESER
EK458-00-EK458-05
21.5 cm

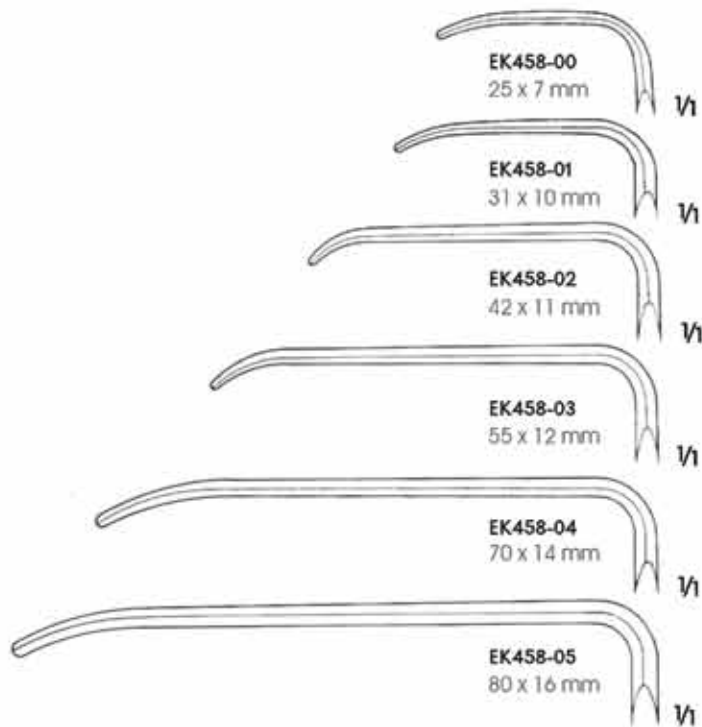



1/2

KOCHER
EK460-00-EK460-04
23 cm

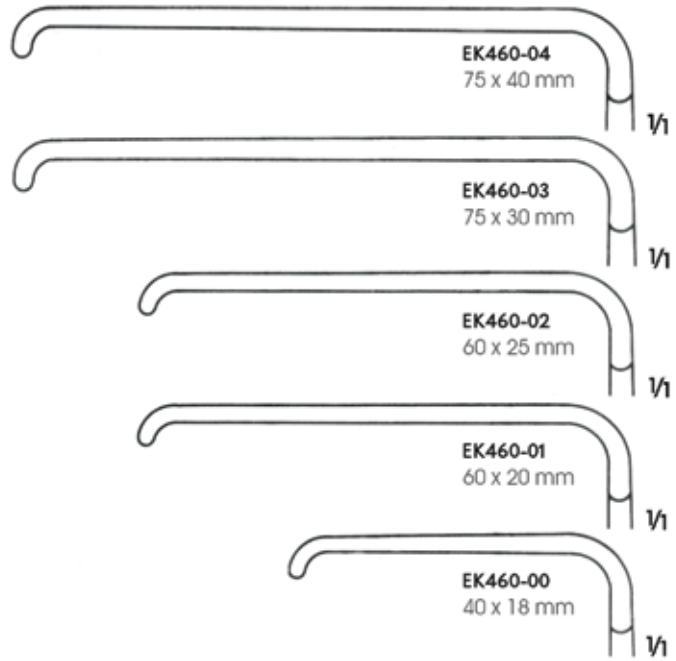

1/2

SAUERBRUCH
EK461-00-EK461-02
22.5 cm

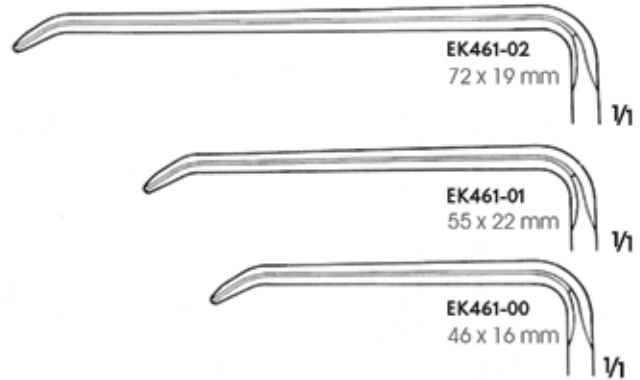

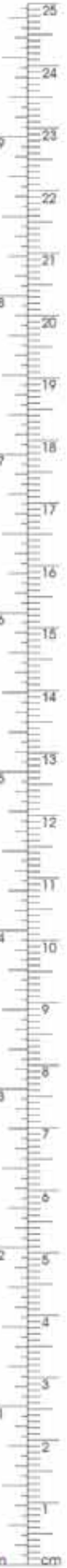
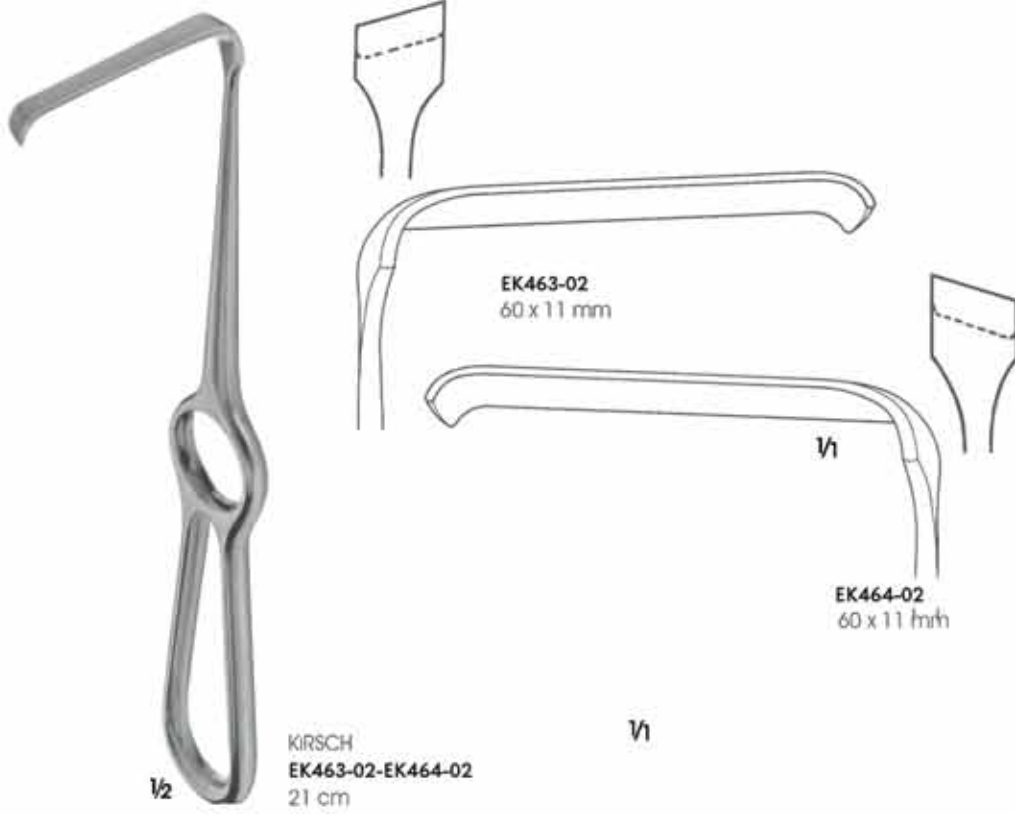

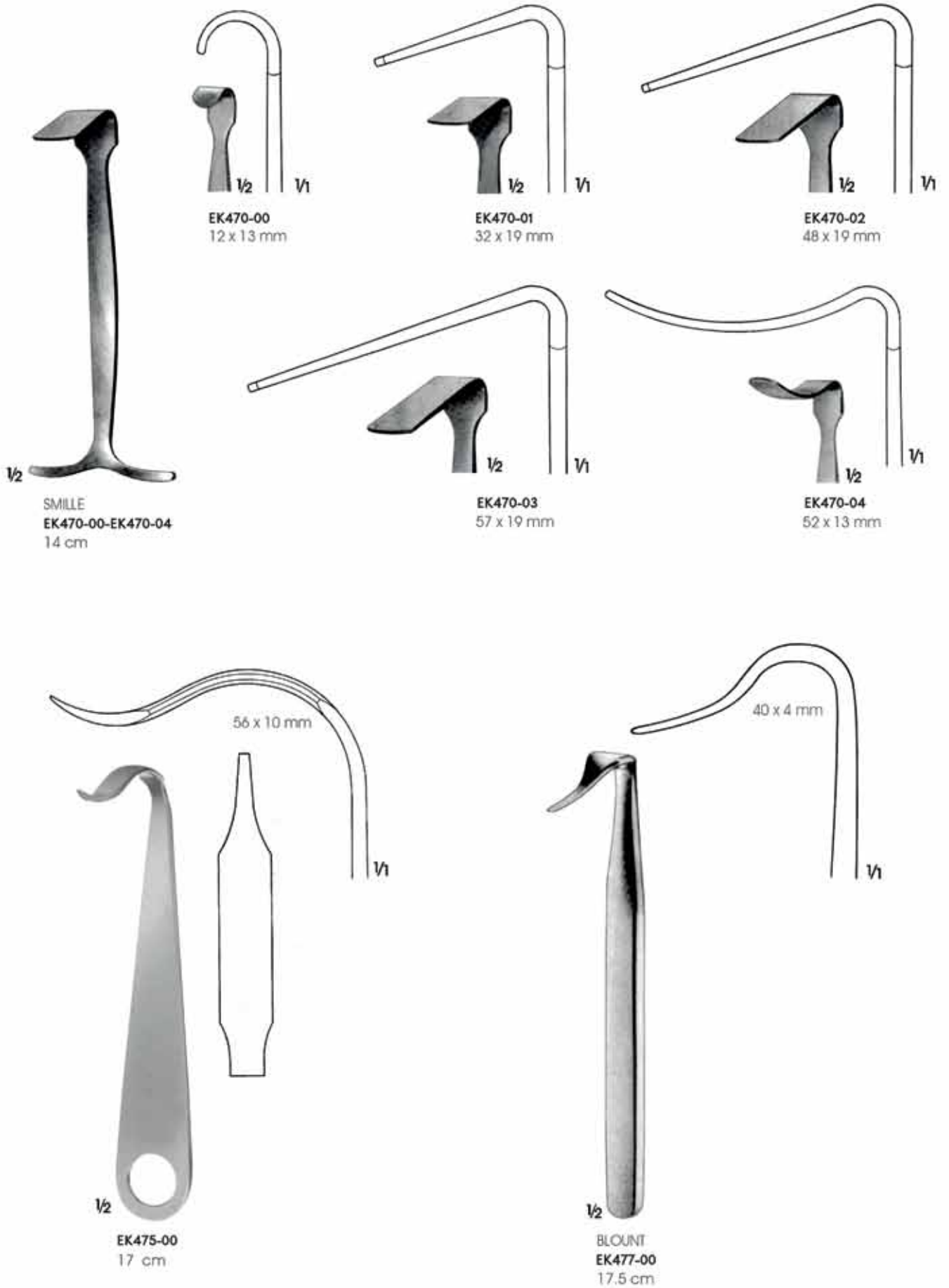

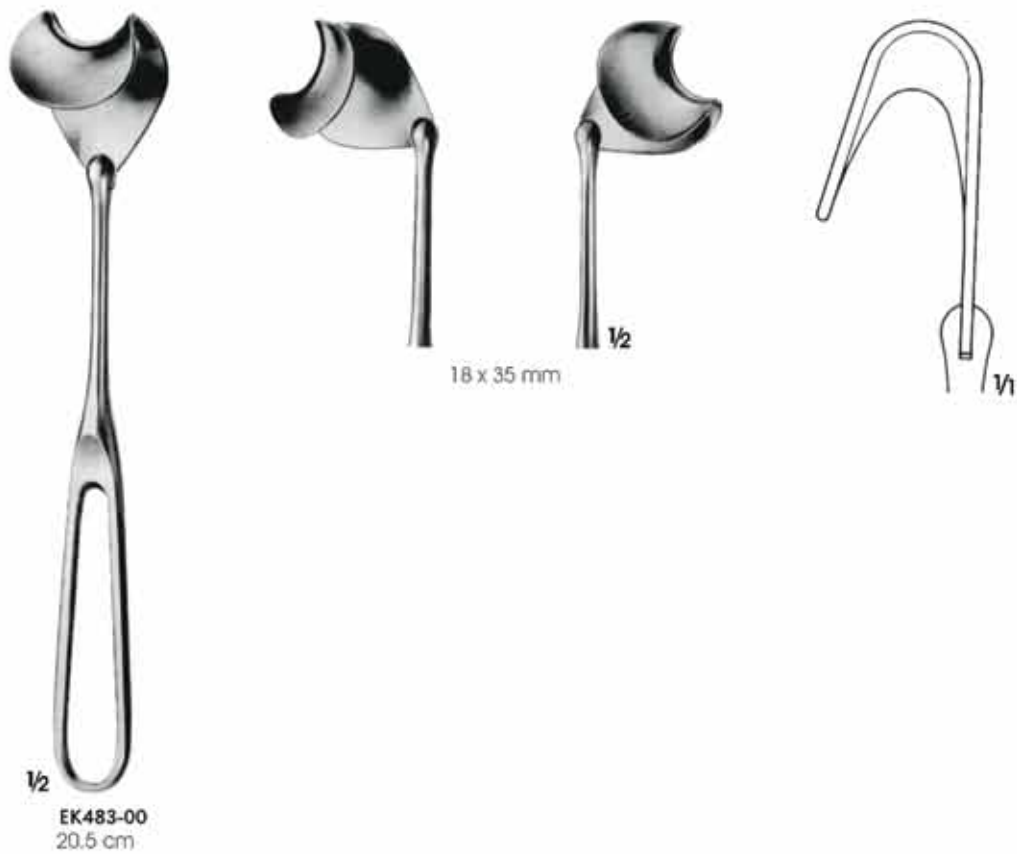
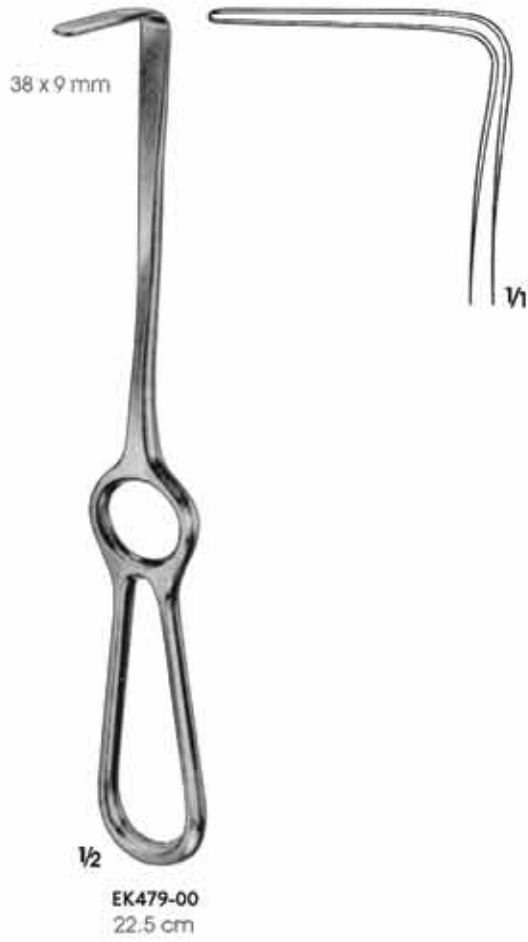



MIDDELDORPF
EK480-00-EK480-02



EK480-00
15 x 15 mm
22 cm



EK480-01
20 x 22 mm
21.5 cm

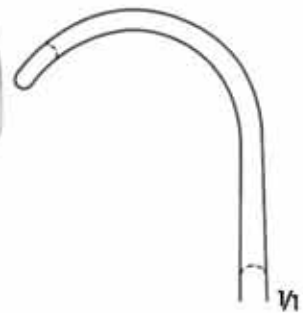

EK480-02
28 x 28 mm
23.5 cm



1/2

GREENE
EK481-00
22.5 cm



22 x 22 mm



1/2



1/2

DURHAM
EK482-00
21.5 cm



16 x 25 mm

1/2



1/2



EK490-02
37 x 37 mm

1/1



EK490-01
30 x 29 mm

1/1



EK490-00
23 x 20 mm

1/1

RICHARDSON
EK490-00-EK490-02
24 cm



1/2

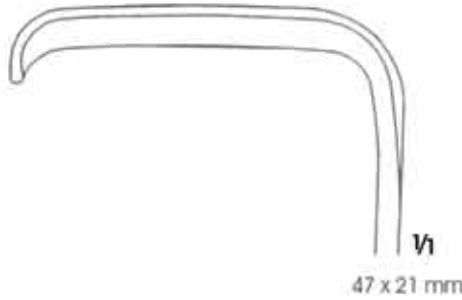

47 x 21 mm

1/1

RICHARDSON
EK491-00
24 cm

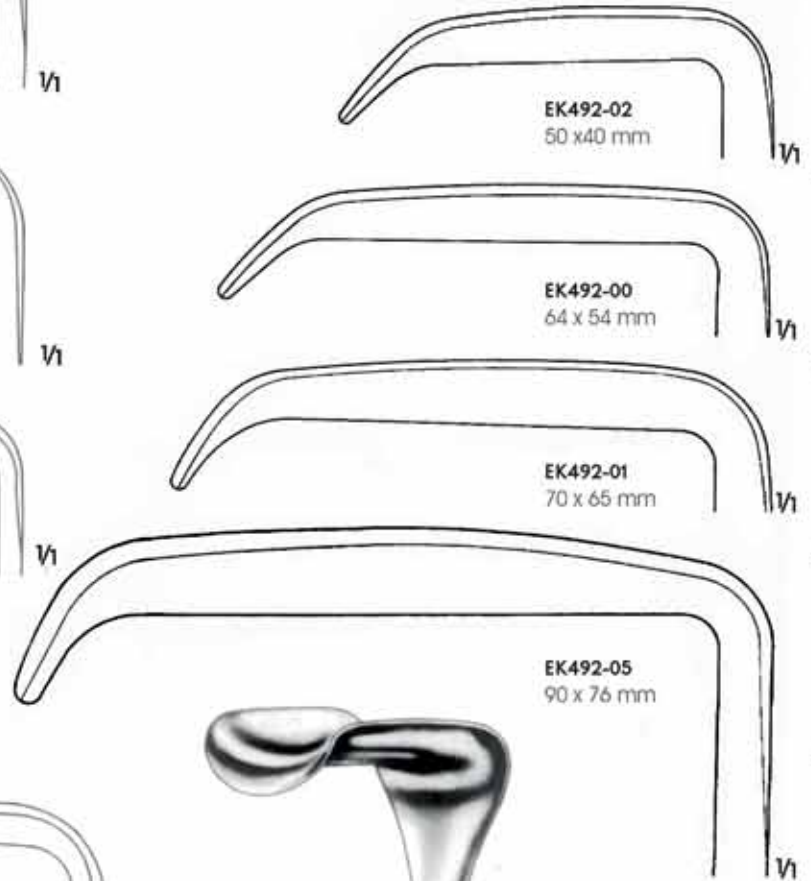

EK492-02
50 x 40 mm

1/1

EK492-00
64 x 54 mm

1/1

EK492-01
70 x 65 mm

1/1

EK492-05
90 x 76 mm

1/1



1/2

KELLY
EK492-00-EK492-05
26 cm

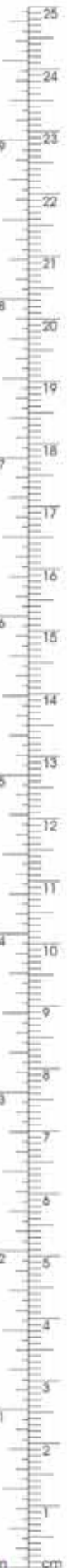

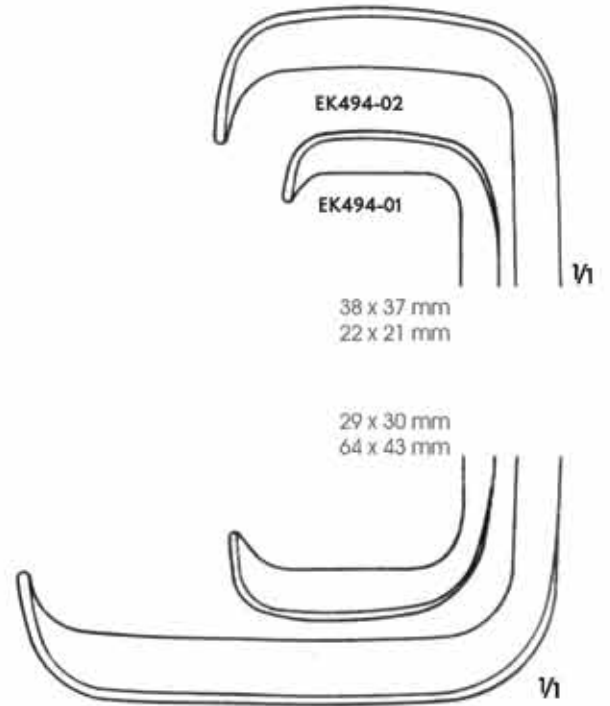
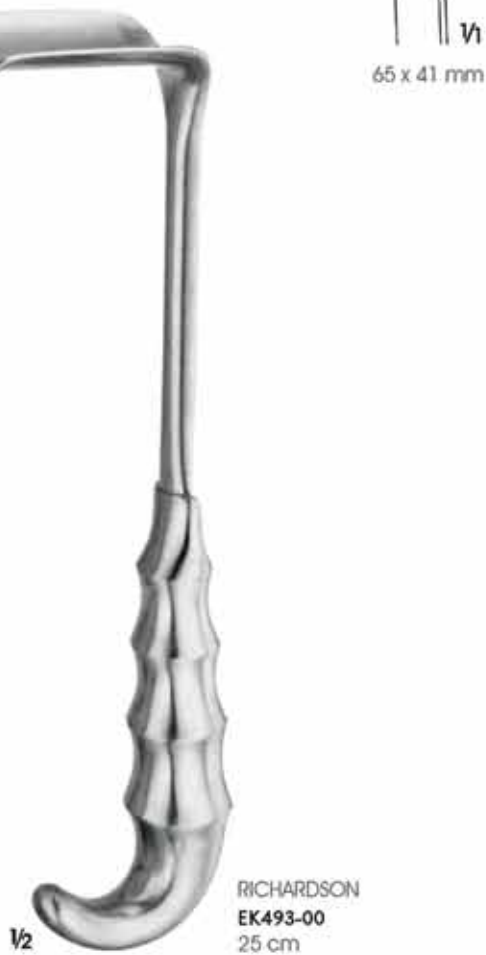

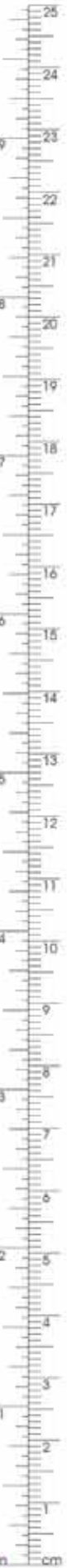
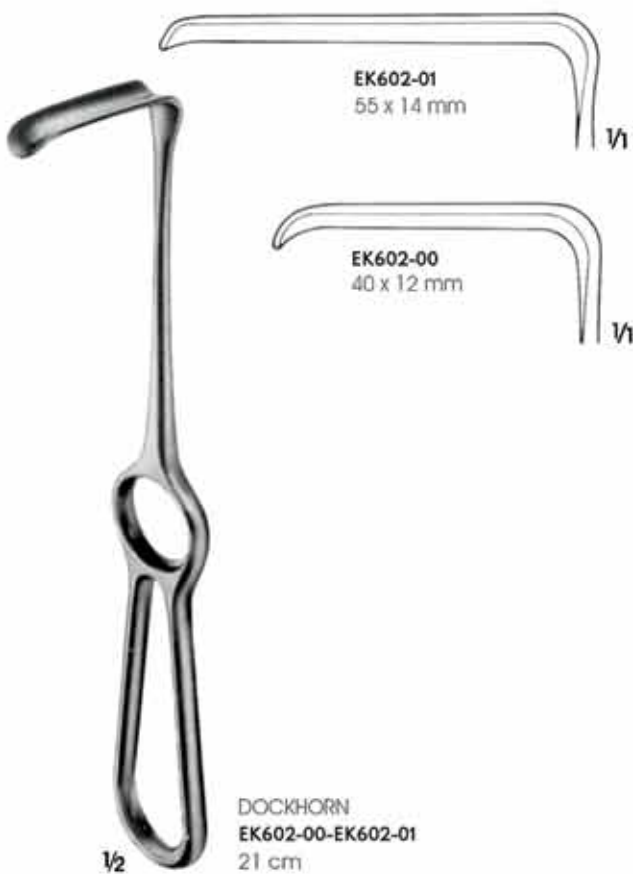

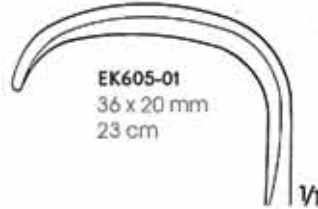

EK605-01
36 x 20 mm
23 cm

1/1

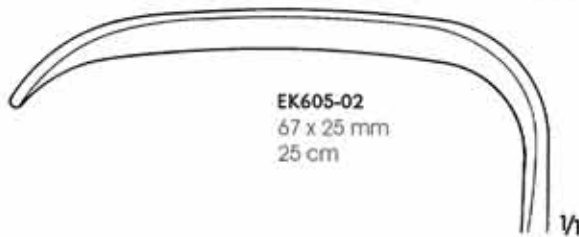

EK605-02
67 x 25 mm
25 cm

1/1



EK605-04 80 x 42 mm
EK605-05 80 x 50 mm
EK605-06 80 x 60 mm
25 cm

1/1



EK606-00 70 x 40 mm
EK606-01 70 x 50 mm
EK606-02 70 x 65 mm

1/1



KOCHER
EK605-01-EK605-06



MORRIS
EK606-00-EK606-02
24.5 cm

1/2



EK607-02
89 x 50 mm
25.5 cm



EK607-01
76 x 25 mm
23 cm



EK607-00
52 x 16 mm
23 cm



MEYERDING
EK607-00-EK607-02



EK608-03
94 x 36 mm

EK608-02
64 x 25 mm

EK608-01
36 x 20 mm

EK608-00
20 x 15 mm

1/2

KOCHER-WAGNER
EK608-00-EK608-03
28 cm

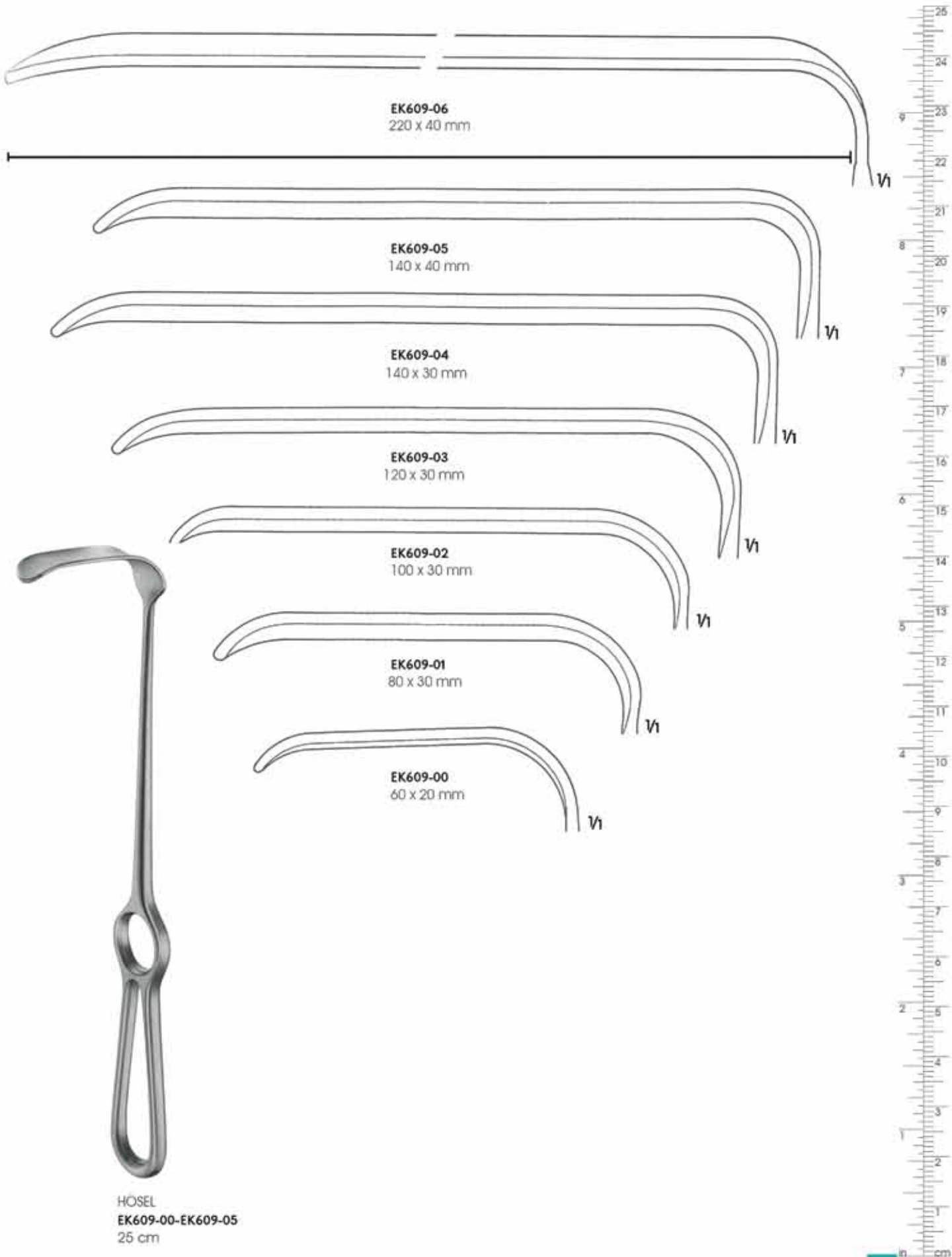





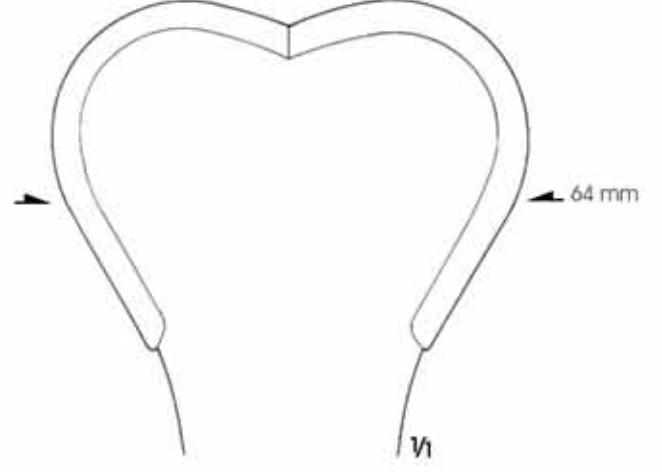
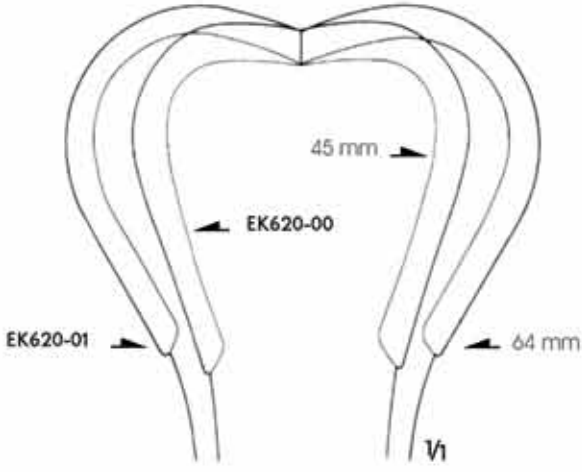

1/2
HARRINGTON
EK620-00 123 x 45 mm
EK620-01 123 x 64 mm
Esnek/Flexible
29.5 cm

1/2
HARRINGTON-PEMBERTON
EK621-00 175 x 64 mm
Esnek/Flexible
29.5 cm



ALLISON
EK625-02
25.5 cm



ALLISON
EK625-05
32 cm

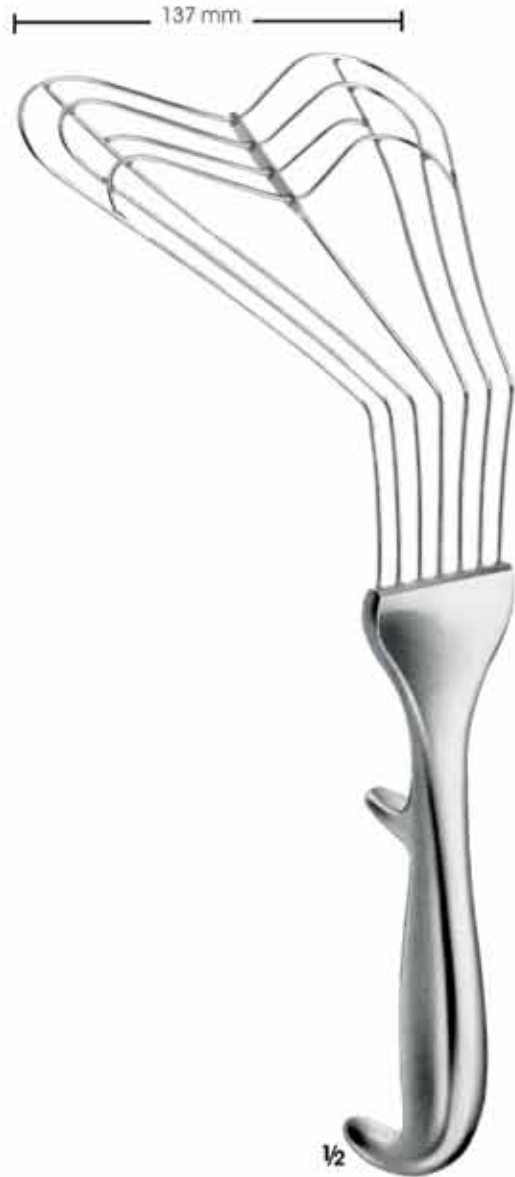

ALLISON
EK628-02
30 cm

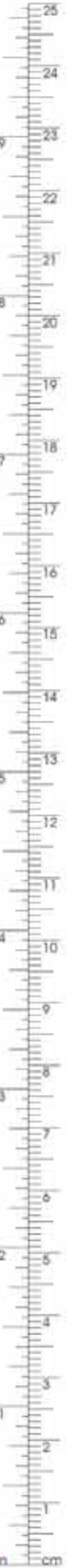

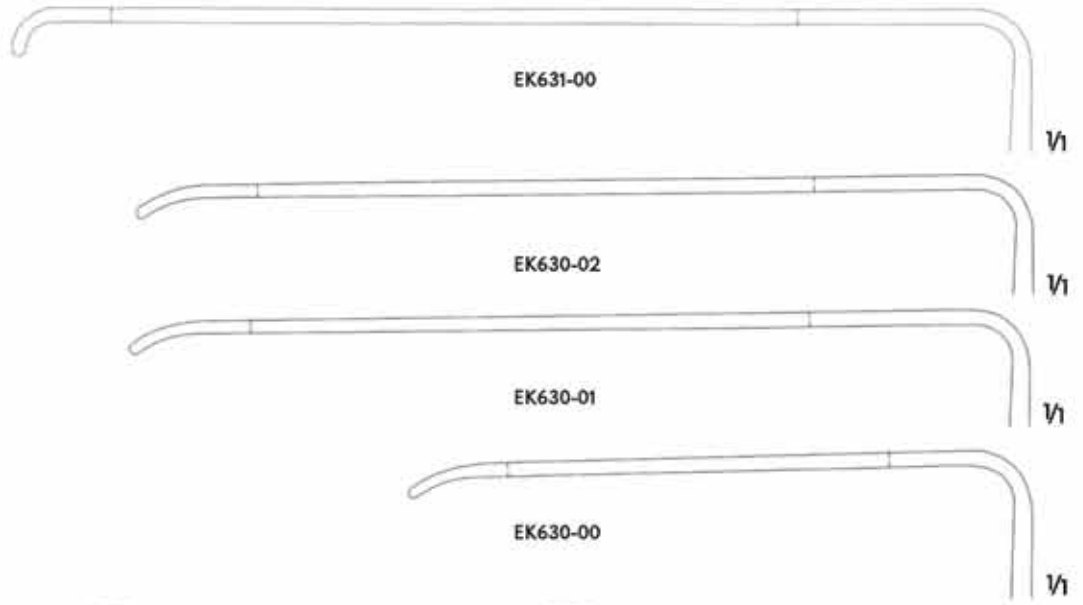

CORYLLOS
EK630-00-EK630-02
25.5 cm

SAUERBRUCH
EK631-00
26 cm

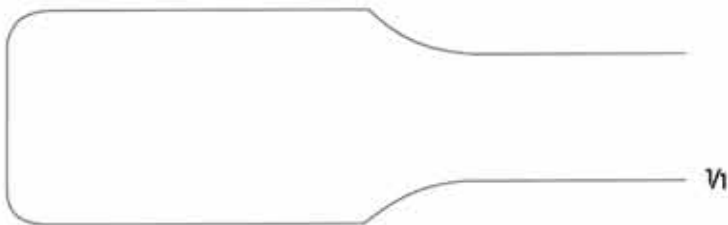

EK635-02
26 cm



BRUNNER
EK640-00
24 cm





DAVIDSON
EK637-03
19.5 cm



DAVIDSON
EK637-01
19.5 cm

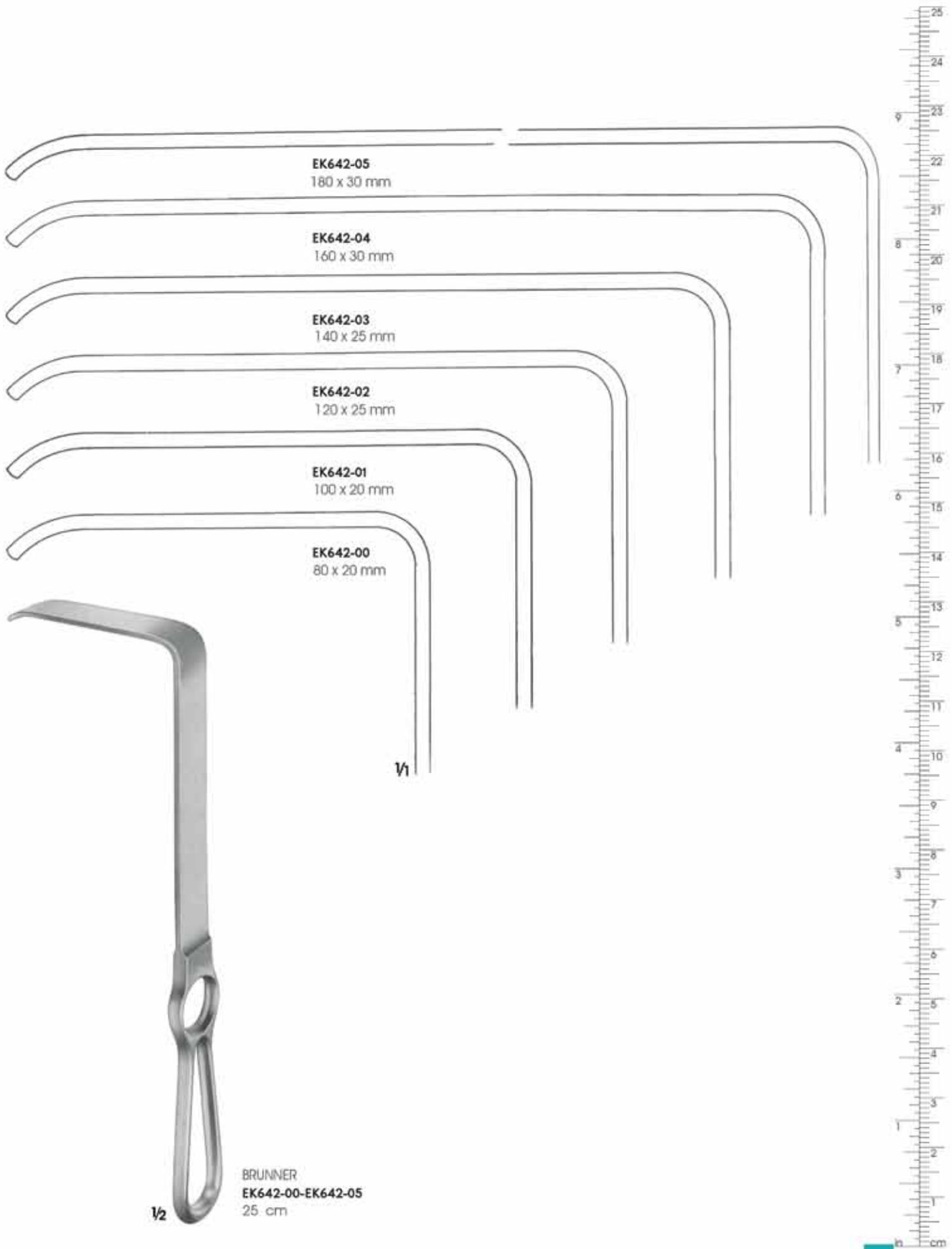

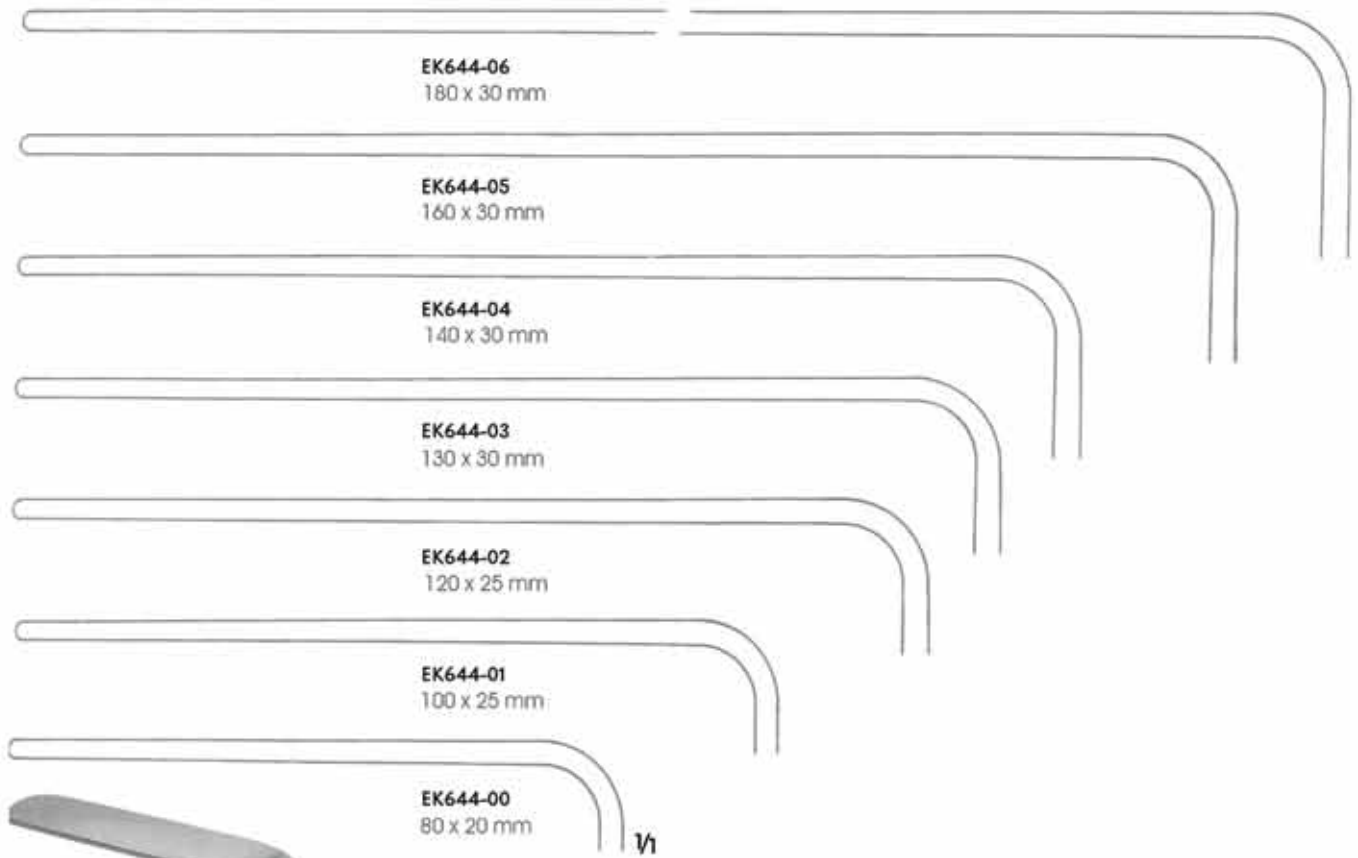

BRUNNER
EK644-00-EK644-06
27.5 cm



HASSON
EK661-00-EK661-01



1/2
EK661-00
10 x 160 mm



1/2
EK661-01
13 x 180 mm

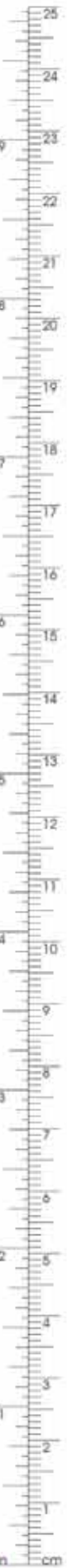

19 mm
1/2
DEAVER
EK660-01
18 cm



22 mm
1/2
DEAVER
EK660-02
21.5 cm



25 mm
1/2
DEAVER
EK660-03
23.5 cm



DEAVER
EK660-04
30 cm



DEAVER
EK660-05
31.5 cm





75 mm

1/2

DEAVER
EK660-08
32 cm



25 mm

1/2

DEAVER
EK660-09
36.5 cm



DEAVER
EK668-04
31 cm



DEAVER
EK668-05
31 cm

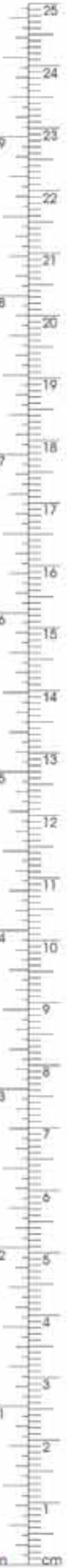



50 mm

1/2

1/2

DEAVER
EK668-07
30,5 cm



75 mm

1/2

1/2

DEAVER
EK668-08
31 cm



LERICHE
EK670-00
25.5 cm



LERICHE
EK670-02
27.5 cm

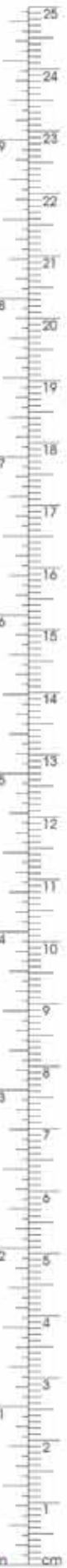

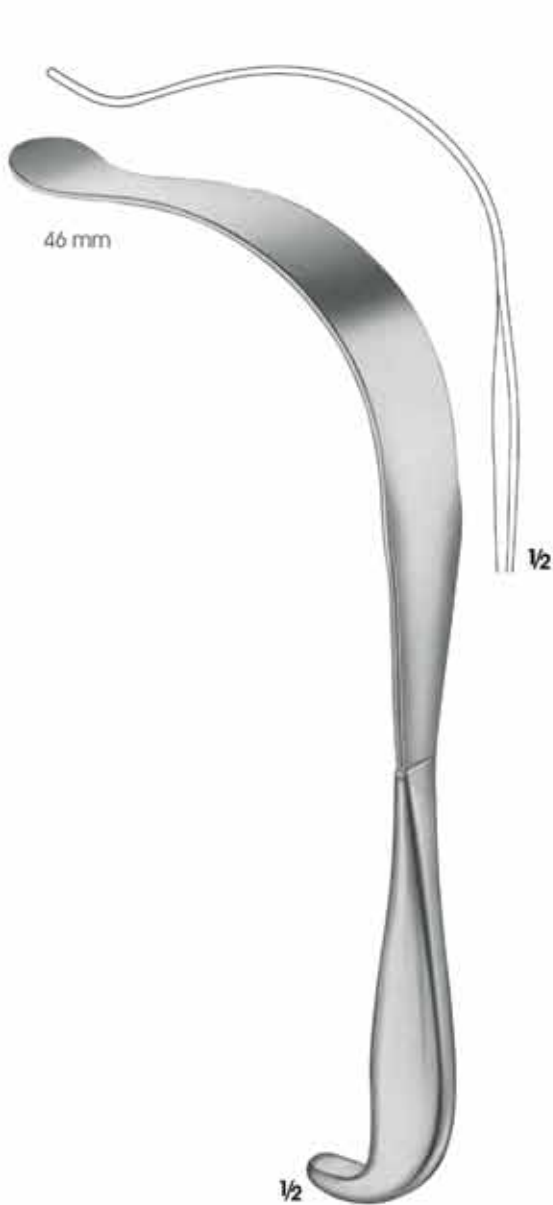

KÜMMEL
EK672-00
Bükülebilir/Malleable
28.5 cm



KÖRTE
EK678-02
30 cm



1/2

EK726-00
Prostat ekartör
Prostate retractor
36 cm



1/2

EK727-00
Üretral ekartör
Urethral retractor
39 cm

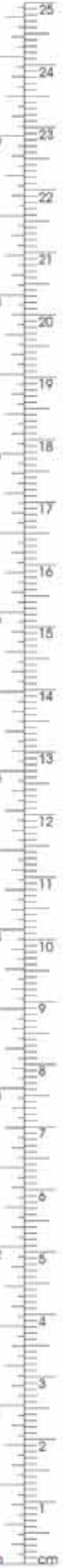

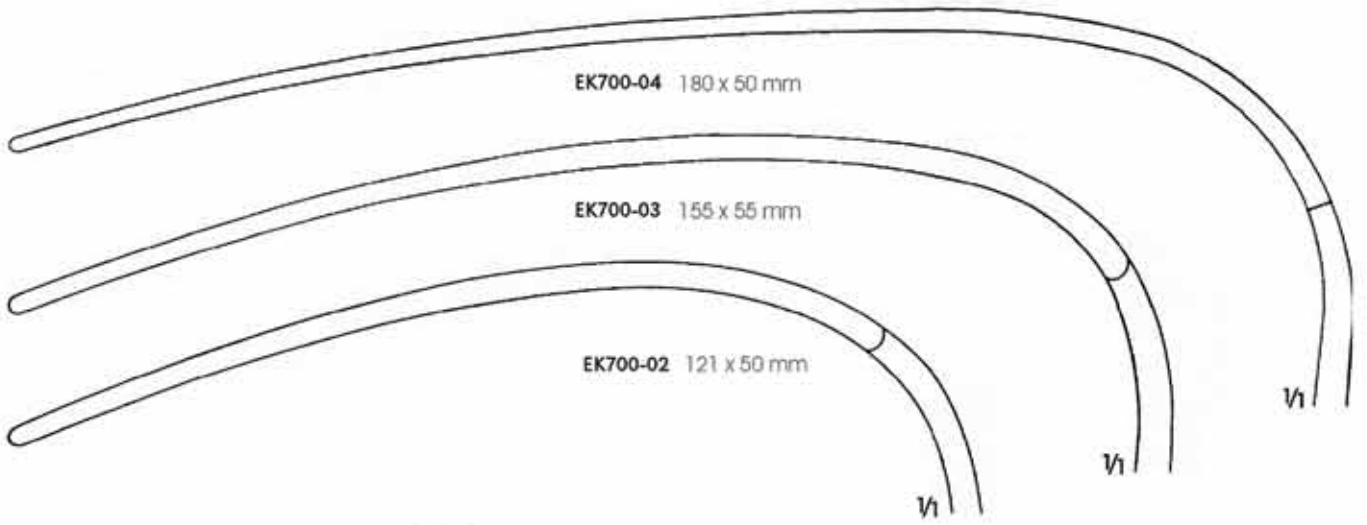

1/2
MIKULICZ
EK700-01
24 cm



1/2
MIKULICZ
EK700-02-EK700-03
25 cm
EK700-04
26 cm

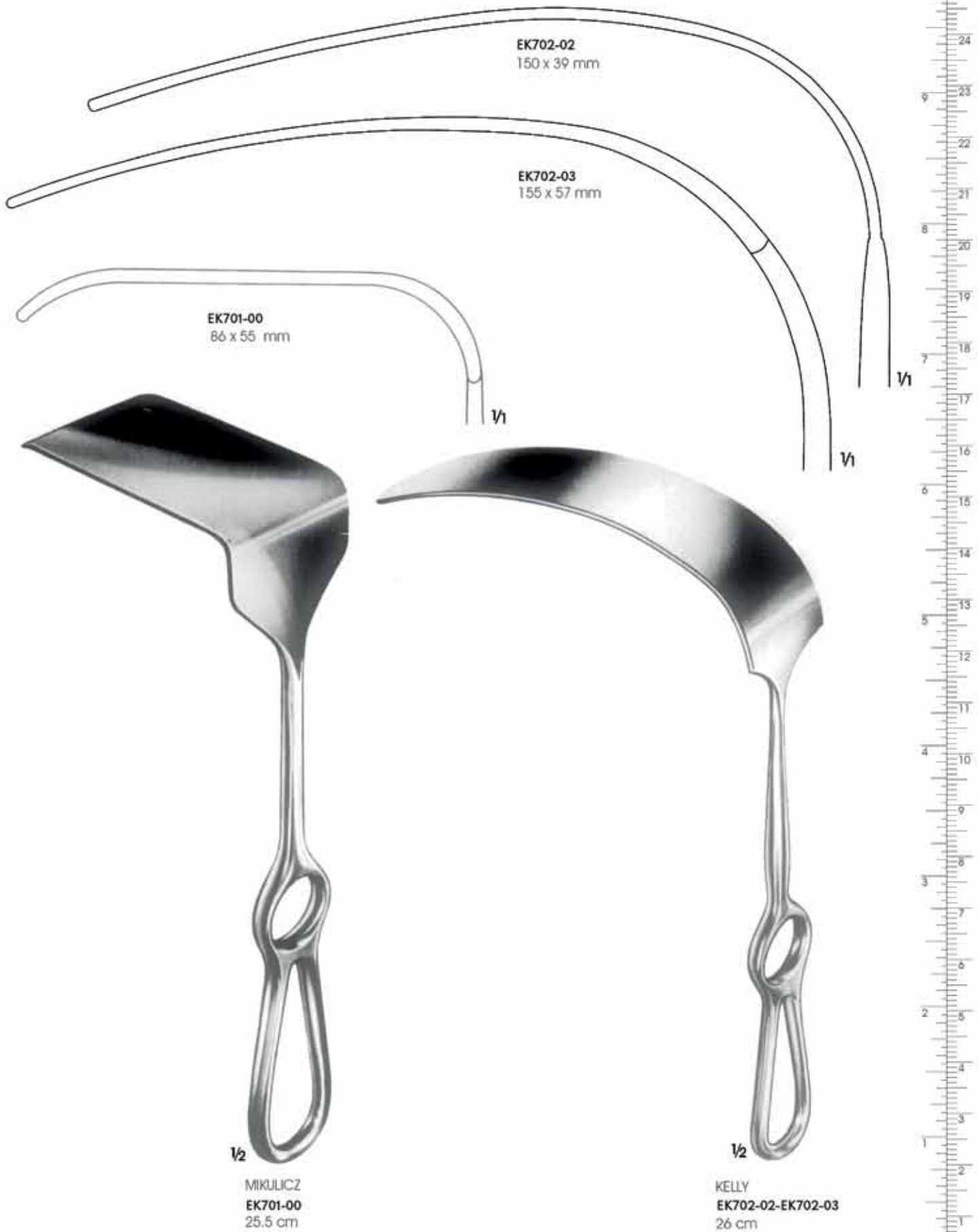

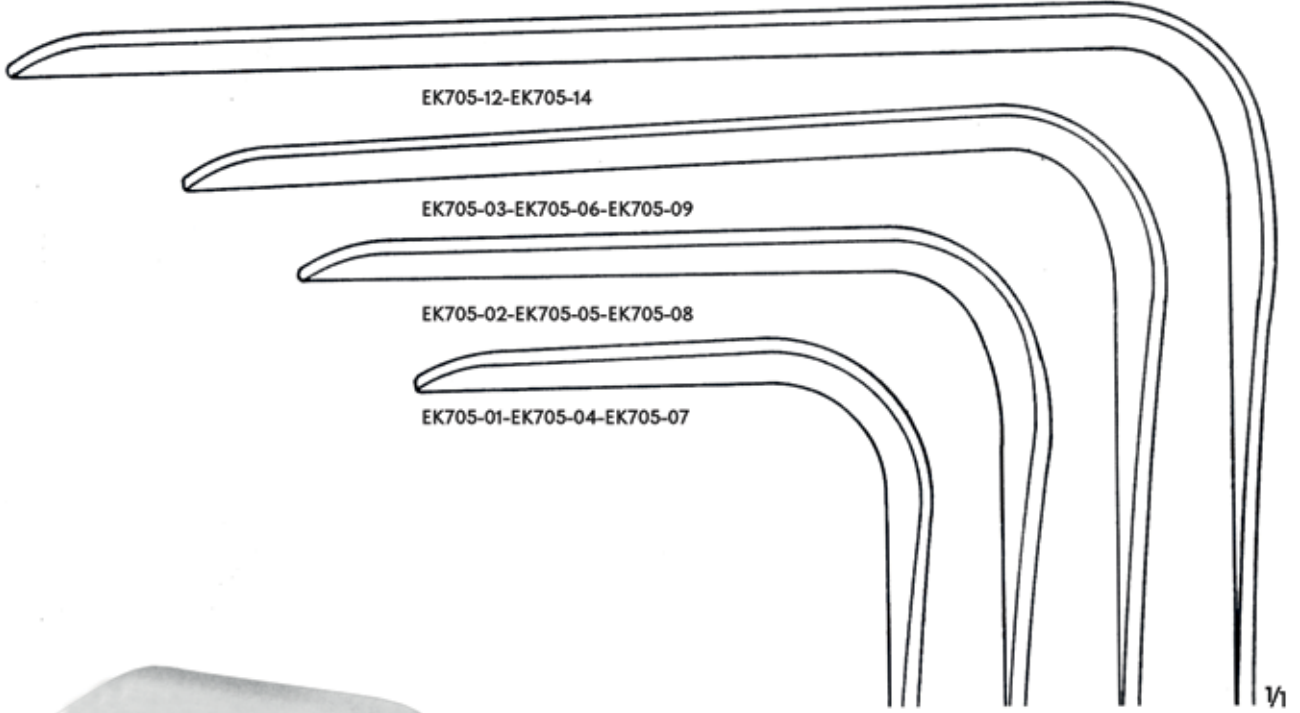

DOYEN
EK705-01-EK705-14
24 cm

Ağız uzunlukları Length of blades	Ağız genişlikleri Width of blades		
60 mm	EK705-01	EK705-04	EK705-07
90 mm	EK705-02	EK705-05	EK705-08
120 mm	EK705-03	EK705-06	EK705-09
160 mm		EK705-12	EK705-14



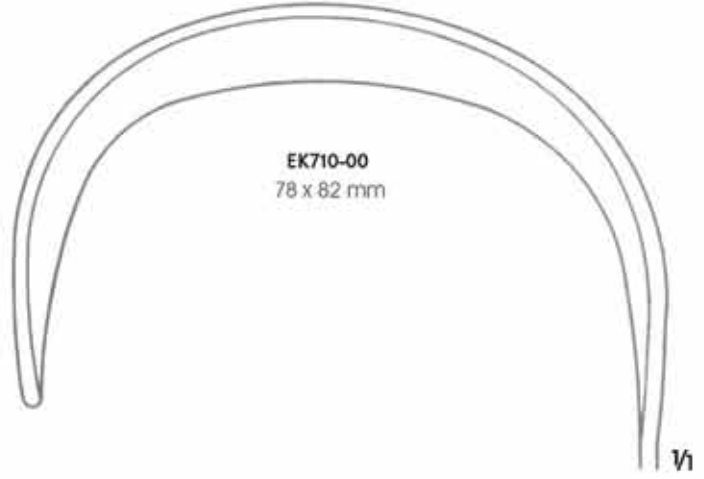
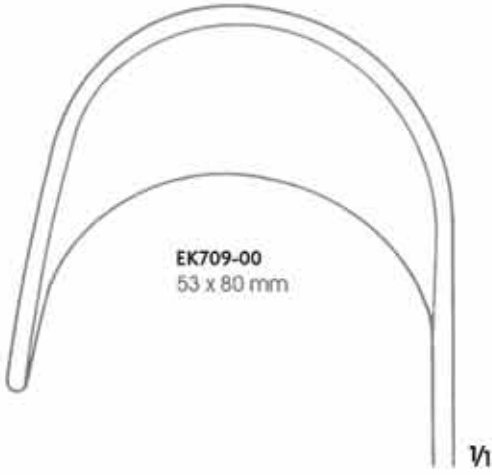

DOYEN
EK709-00
25 cm



DOYEN
EK710-00
26 cm



1/2

FRITSCH
EK715-01-EK715-05
23.5 cm

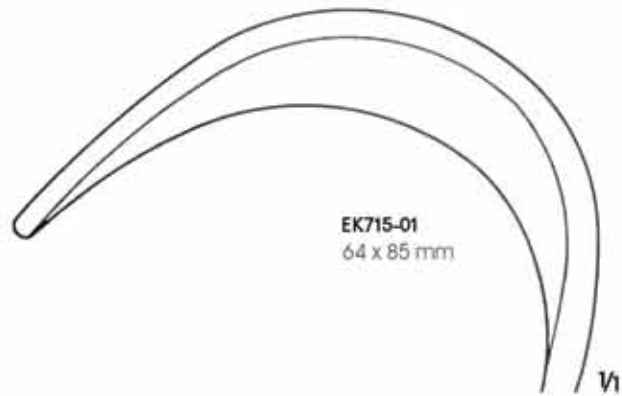

EK715-01
64 x 85 mm

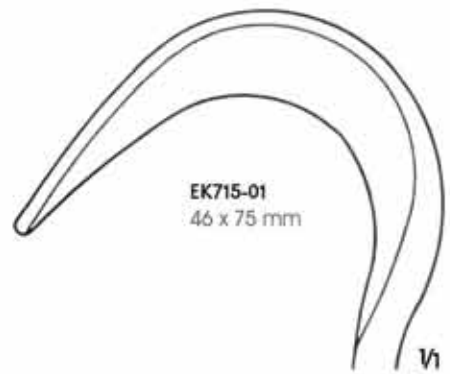

EK715-01
46 x 75 mm

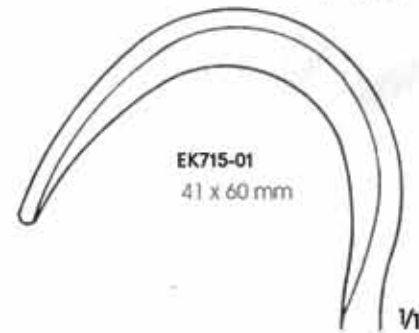

EK715-01
41 x 60 mm

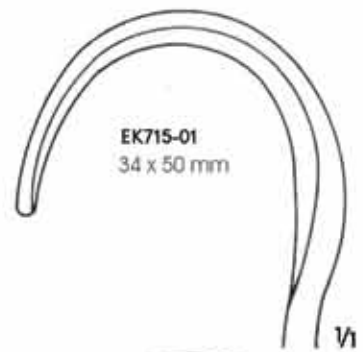

EK715-01
34 x 50 mm

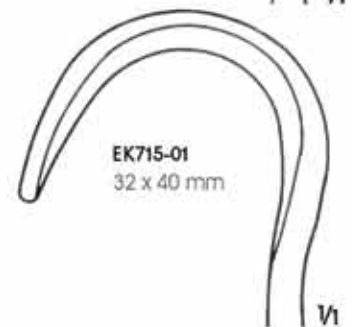

EK715-01
32 x 40 mm



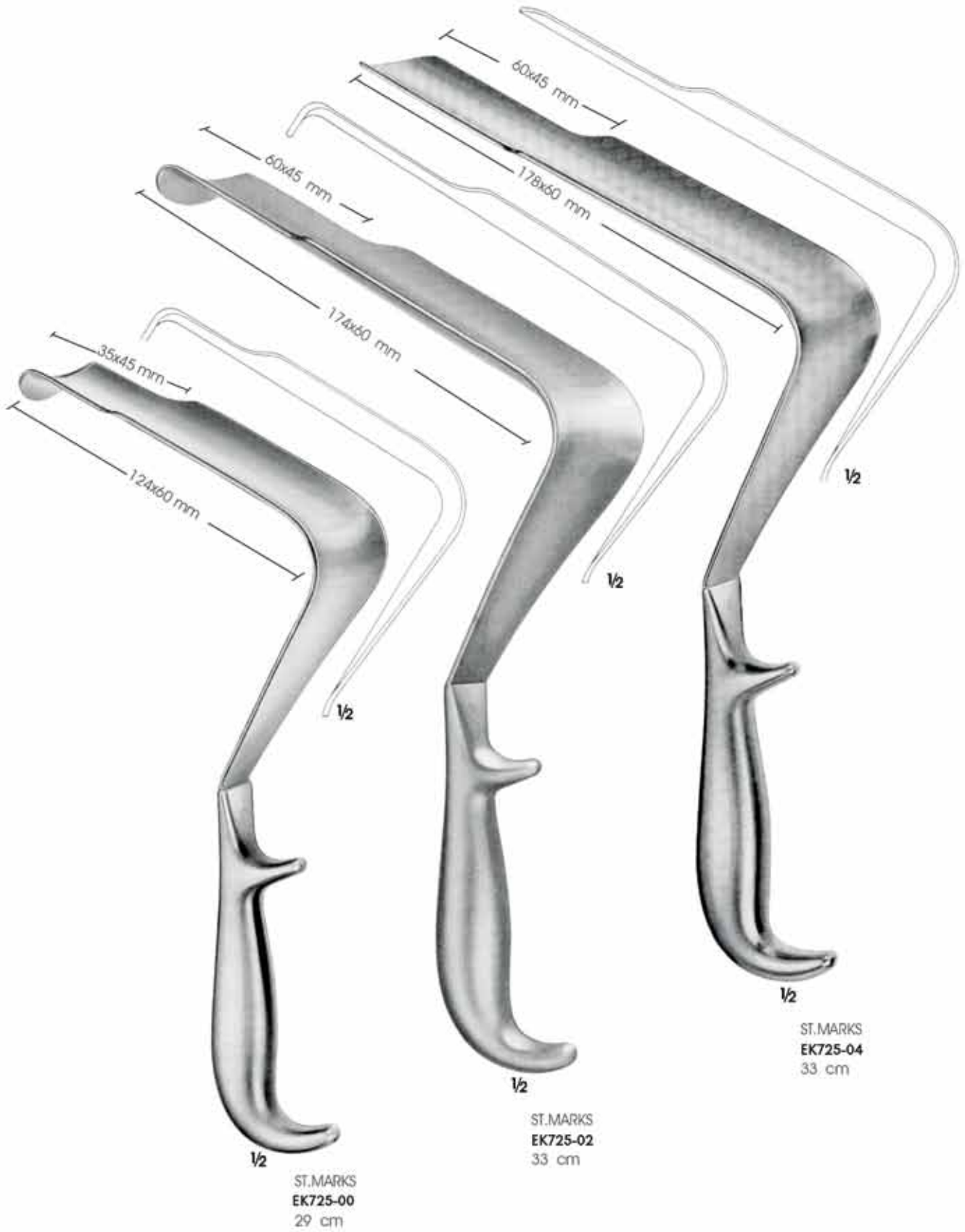





BRUNNER
EK728-00
24 cm



BRUNNER
EK728-02
Işık taşıyıcı/With light carrier
24 cm



MIKULICZ
EK730-00 120 x 50 mm
EK730-01 150 x 50 mm
Işık taşıyıcı/With light carrier
26 cm



53 x 85 mm

DOYEN
EK731-00
25 cm



DOYEN
EK731-10
Işık taşıyıcı/With light carrier
25 cm

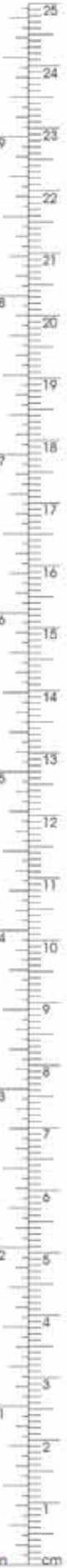



1/3
DOYEN
EK732-00 48 x 90 mm
EK732-01 48 x 105 mm
EK732-02 48 x 120 mm
EK732-03 48 x 135 mm
28 cm



1/3
ROCHARD
EK739-00 48 x 90 mm
EK739-01 48 x 105 mm
EK739-02 48 x 120 mm
EK739-03 48 x 135 mm
EK739-04 48 x 155 mm
31 cm



1/3
ET790-01 Komple /Complete
(K 736.00) Zinc/With chain
(T 790.00/645 gr.)Ağırlık/Weight
79 cm



1/3
ROCHARD
EK737-00-EK739-00

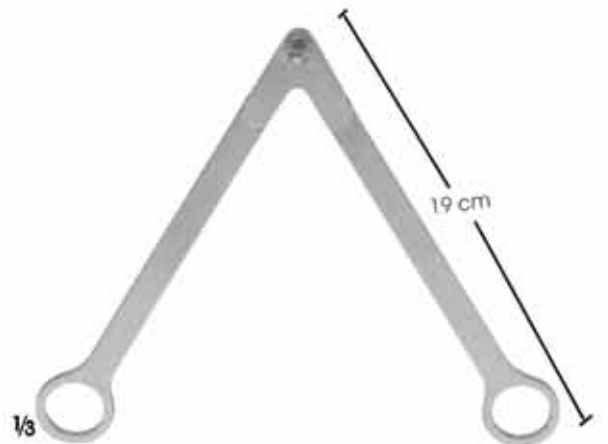

1/3
ROCHARD
EK737-00
Bağlantı feribahı K 739.00-K 739.04
Fixation device for K 739.00-K 739.04

ROCHARD
ET740-00

Daha sağlam bağlantı oluşturmak üzere ameliyat masalarının her iki yan bağlantı rayına bağlanan montaj çerçevesi, sterilizasyon için sökülebilir.
Mounting frame for fastening to both sides of the lateral bars of the operating tables, thus more stability is given, can be dismantled for sterilization.

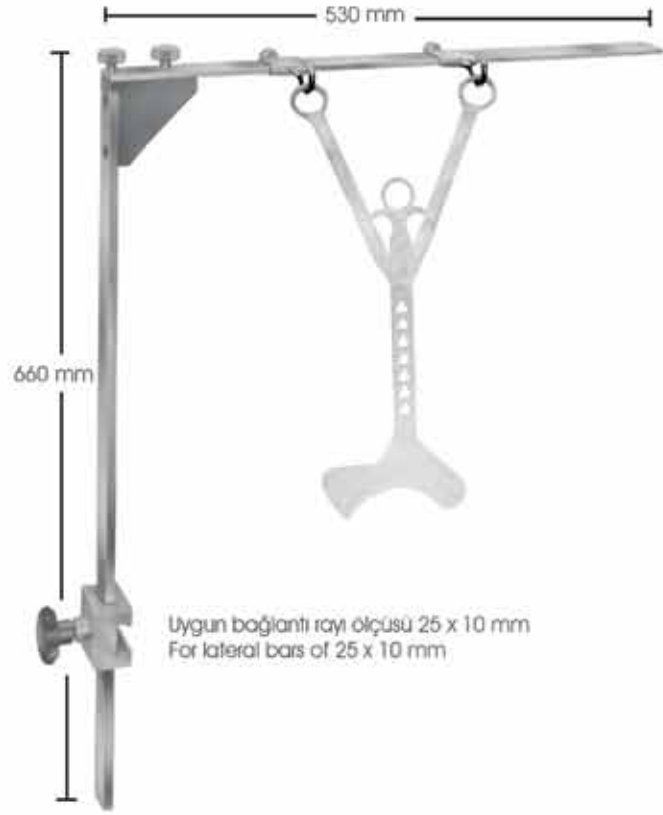

ROCHARD
ET742-00

Daha sağlam bağlantı oluşturmak üzere ameliyat masalarının her iki yan bağlantı rayına bağlanan montaj çerçevesi, sterilizasyon için sökülebilir.
Mounting frame for fastening to both sides of the lateral bars of the operating tables, thus more stability is given, can be dismantled for sterilization.

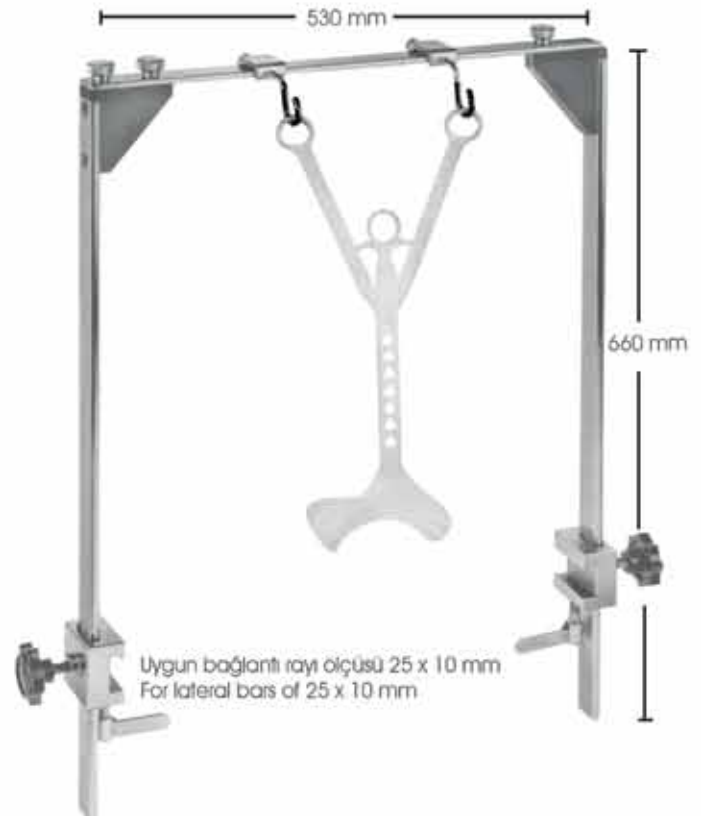



EK752-00 200 x 12 mm
EK752-01 200 x 17 mm
EK752-02 250 x 25 mm
Bükülebilir/Malleable

TUFFIER
EK754-00
Bükülebilir
Malleable
20 cm



EK756-02 30 mm
EK756-04 40 mm
27 cm

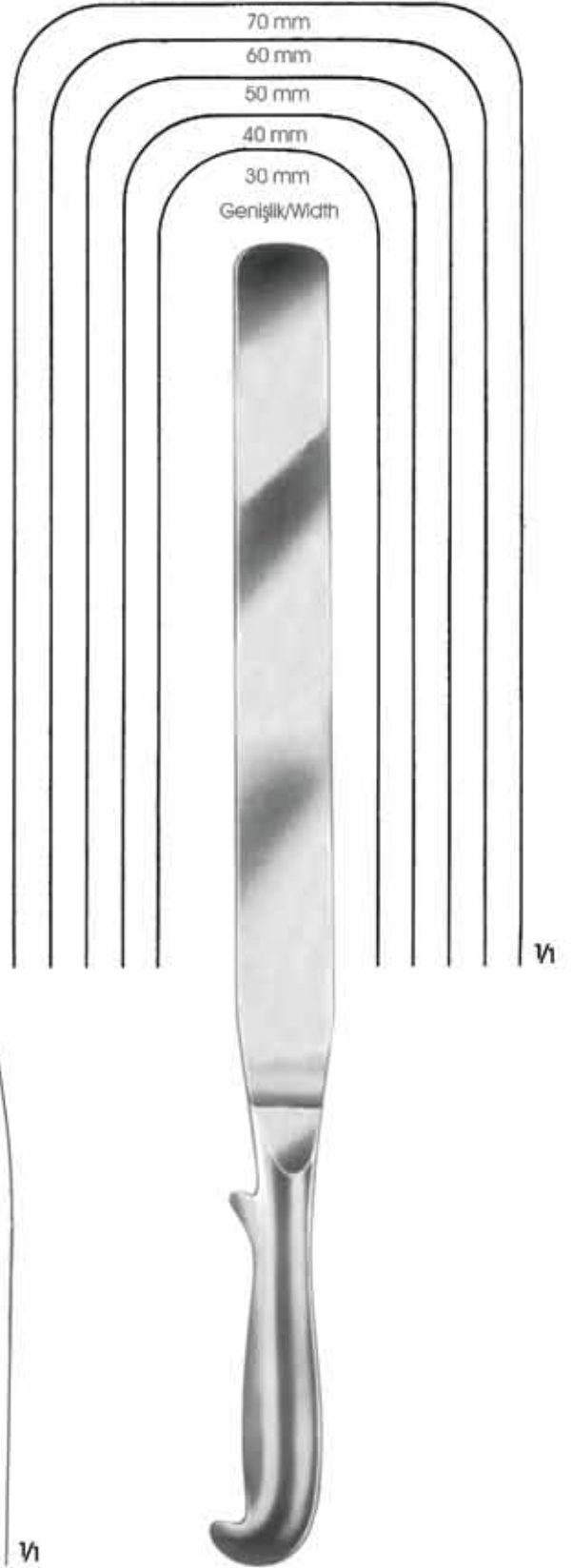

EK758-00 30 mm
EK758-01 40 mm
EK758-02 50 mm
EK758-03 60 mm
EK758-04 70 mm
Bükülebilir/Malleable
41 cm

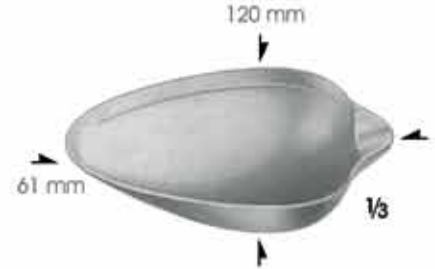

EK866-00
Kan kaşığı/Blood scoop
Hacmi 50 cc/Volume 50 cc



HABERER
EK760-00
Bükülebilir/Malleable
30.5 cm



RIBBON
EK756-04 25 mm
EK756-00 30 mm
EK756-01 40 mm
EK756-02 50 mm
Bükülebilir/Malleable
33 cm



REVERDIN
EK764-00
28.5 cm



KOCHER
EK766-00
Kaşık şeklinde bastıncı
Depressor, spoon shaped
22 cm



EL

Otomatik Ekartörler
Self-Retaining Retractors



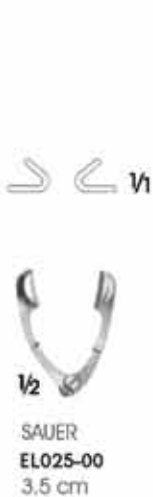
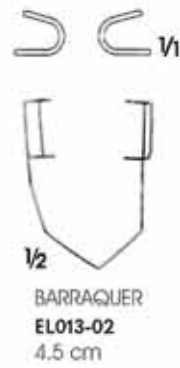
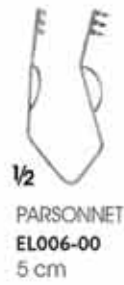



FINSEN
EL082-00
7.5 cm



FINSEN
EL083-00
7 cm



EL085-00
Künt/Blunt 10 cm



EL085-01
Sivt/Sharp
10 cm



ALM
EL088-00 7 cm
EL088-01 10 cm



EL437-00
Otomatik ekartör
Self-retaining retractor
12 cm



ALLPORT
EL089-00
9.5 cm



JANSEN
EL093-00 Sivt/Sharp
10 cm



JANSEN
EL095-00
10 cm



JANSEN
EL097-00
10 cm





1/1



1/2

WEITLANER
EL300-00 Sivri/Sharp
11 cm



1/1



1/2

WEITLANER
EL301-00 Künt/Blunt
11 cm



1/1



1/2

WEITLANER
EL302-00 Yan Sivri/Semi-sharp
11 cm



1/1



1/2

WEITLANER
EL304-00 Sivri/Sharp
13 cm



1/1



1/2

WEITLANER
EL305-00 Künt/Blunt
13 cm



1/1



1/2

WEITLANER
EL306-00 Yan sivri/Semi-sharp
13 cm



WEITLANER
EL308-00
13 cm



WEITLANER
EL309-00
13 cm



WEITLANER
EL312-00 Sivri/Sharp
16.5 cm



WEITLANER
EL313-00 Kunt/Blunt
16.5 cm



WEITLANER
EL314-00 Yarı sivri/Semi-sharp
16.5 cm

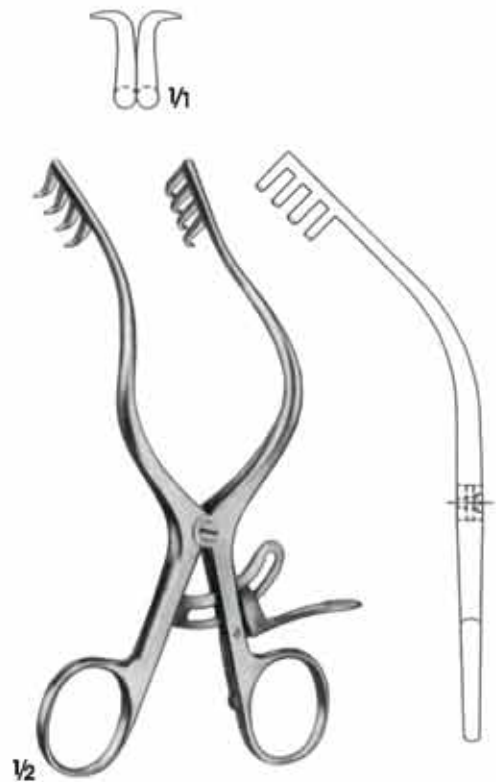

MOLLISON
EL318-00 Sivri/Sharp
15.5 cm



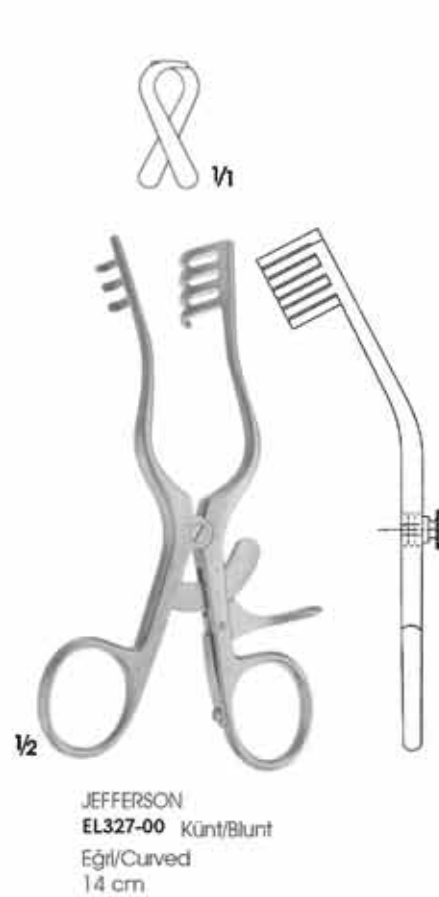
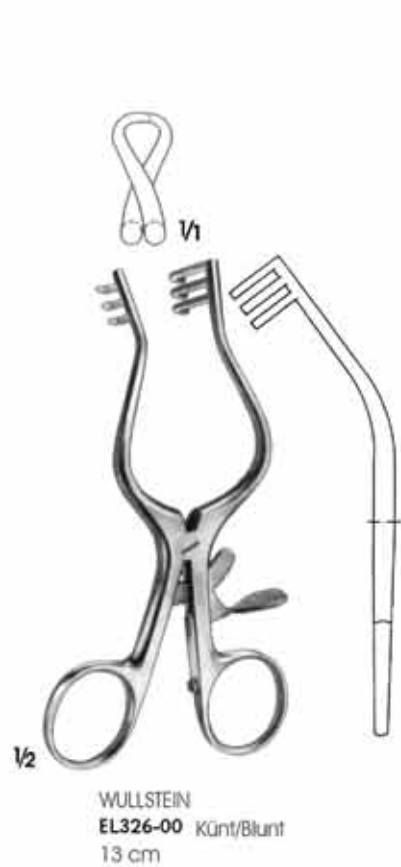
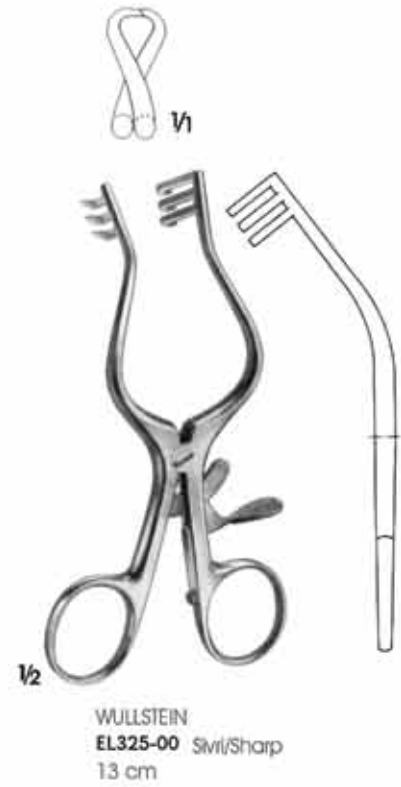



HENDERSON
EL329-00 Sivri/Sharp
18 cm



ADSON-BABY
EL330-02 14 cm
EL331-02 16 cm
Yarı sivri/Semi sharp



ADSON
EL330-04 Sivri/Sharp
EL331-04 Künt/Blunt
16 cm



ADSON
EL330-06 Sivri/Sharp
EL331-06 Künt/Blunt
20 cm



PLESTER
EL335-00 Künt/Blunt
Sol/Left
11 cm



PLESTER
EL336-00 Künt/Blunt
Sağ/Right
11 cm





PLESTER
EL338-00 Sivri/Sharp
13 cm

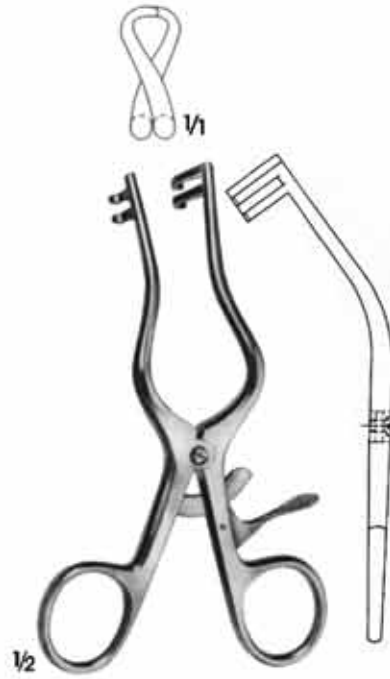

PLESTER
EL339-00 Künt/Blunt
13 cm



MOLLISON
EL340-00 Sivri/Sharp
14 cm



TÜBINGER
EL345-00
16.5 cm



IRWIN
EL347-00 Sivri/Sharp
17.5 cm

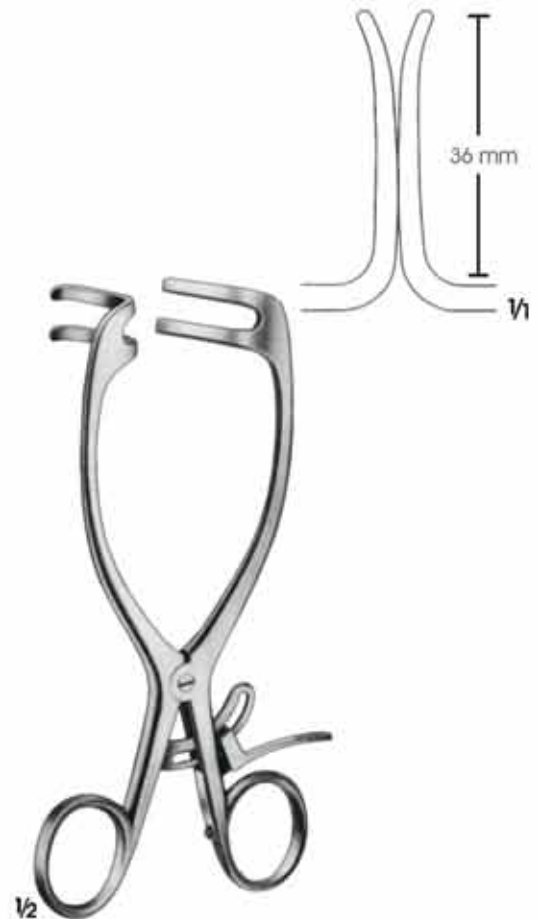

MAYO-ADAMS
EL348-00
16.5 cm



WEITLANER
EL350-00 Sivri/Sharp
EL351-00 Kunt/Blunt
18 cm



EL402-03
Sadece ekartör/Retractor only
Kunt/Blunt
17 cm

ALLENBERG
EL402-00 Komple/Complete
EL402-03 Sadece ekartör, kunt
Retractor only, blunt 17 cm
EL402-05 Bleyd/Blade 12 cm
35 x 10 mm - 20 x 12 mm
Karotis ekartör/Carotid retractor
system



TRAVERS
EL352-00
Kunt/Bulunt
Laminektomi ekartör
Laminectomy retractor
21.5 cm

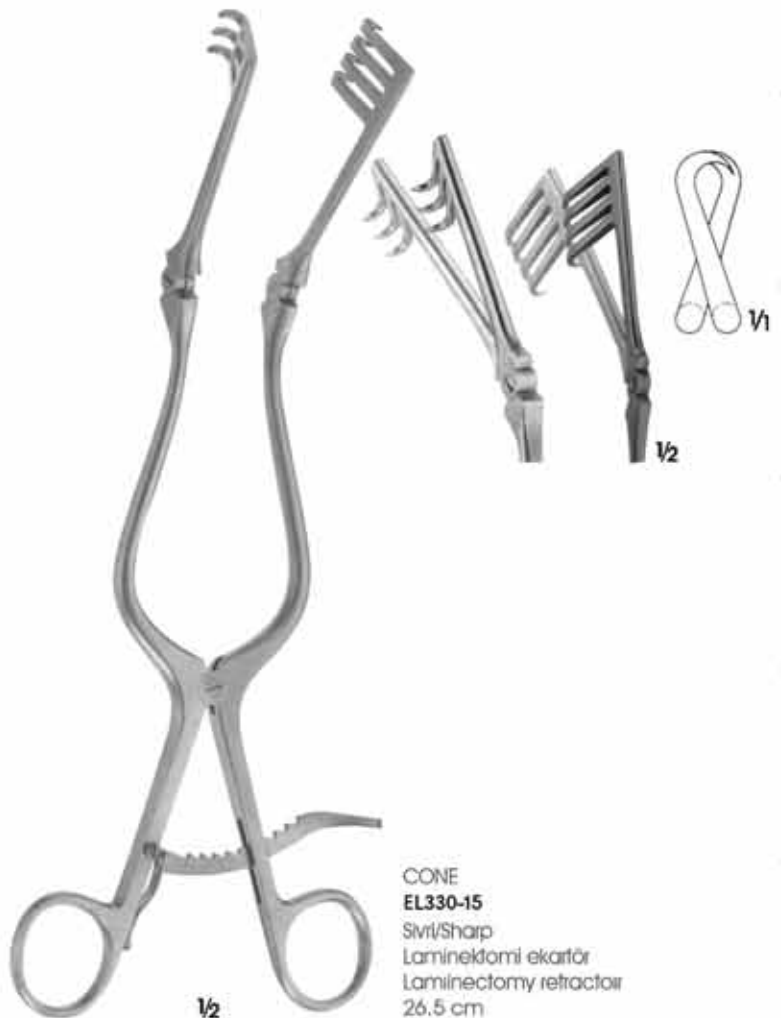

CONE
EL330-15
Sivri/Sharp
Laminektomi ekartör
Laminectomy retractor
26.5 cm





EL353-01
Sivri/Sharp
19.5 cm

EL353-02
Sivri/Sharp
24 cm

EL353-03
Sivri/Sharp
25.5 cm



EL355-01
Yarı sivri
Semi-sharp
19.5 cm

EL355-02
Yarı sivri
Semi-sharp
24 cm

EL355-03
Yarı sivri
Semi-sharp
25.5 cm



EL354-01
Künlü/Blunt
19.5 cm

EL354-02
Künlü/Blunt
24 cm

EL354-03
Künlü/Blunt
25.5 cm



WEITLANER
EL353-01-EL354-03



MISKIMON
EL360-00 Sivi/Sharp
19 cm



NORFOLK-NORWICH
EL362-00 Künt/Blunt
22 cm



ADSON
EL364-00 Sivi/Sharp
26.5 cm



1/2

1/2

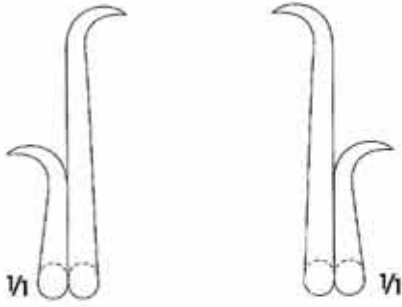

EL366-02
Hemi Laminektomi ekartör/Sivri
Hemi-laminectomy retractor/Sharp
28 cm

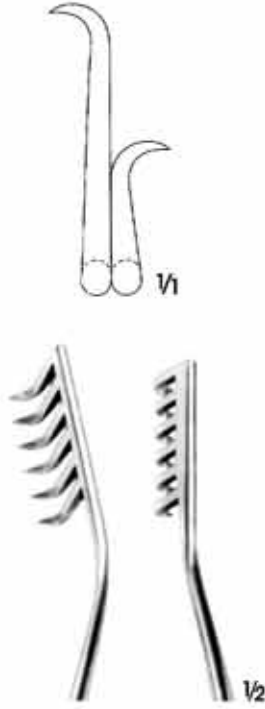

EL368-02
Sivri/Sharp
28 cm



BECKMANN-ADSON
EL370-02
Sivri/Sharp
31 cm



BECKMANN-ADSON
EL371-02
Yarı sivri/Semi-sharp
31 cm

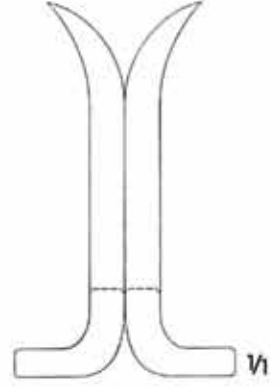
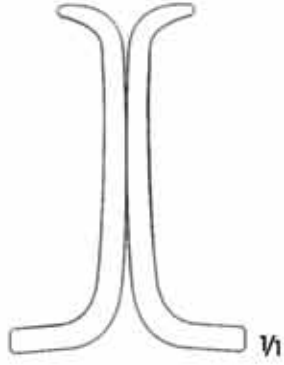

1/2

HARLEY JACKSON
EL373-02
Sivri/Sharp
28 cm



ADSON
EL375-02
Yarı Sivri/Semi Sharp
32 cm



BECKMANN-EATON
EL377-02 Sivri/ Sharp
32 cm





MEYERDING
EL380-01-EL381-05
18 cm



MEYERDING
EL380-00-EL381-04
18 cm

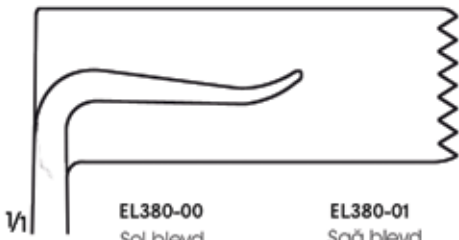

EL380-00
Sol bleyd
Left blade

EL380-01
Sağ bleyd
Right blade

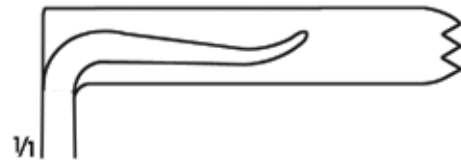

EL380-00
Sol bleyd
Left blade

EL380-01
Sağ bleyd
Right blade

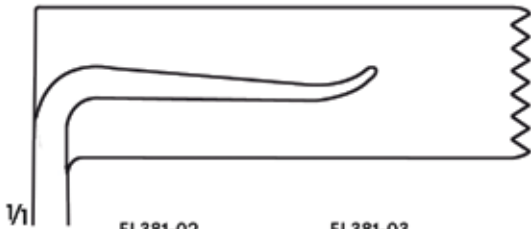

EL381-02
Sol bleyd
Left blade

EL381-03
Sağ bleyd
Right blade

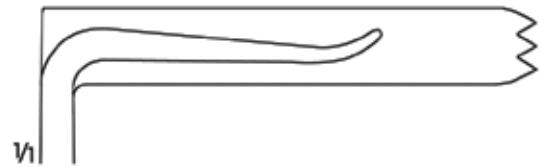

EL380-02
Sol bleyd
Left blade

EL380-03
Sağ bleyd
Right blade

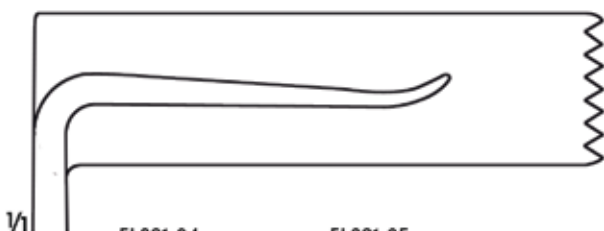

EL381-04
Sol bleyd
Left blade

EL381-05
Sağ bleyd
Right blade

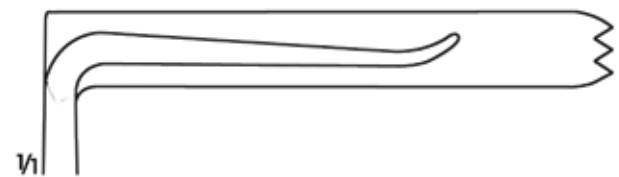

EL380-04
Sol bleyd
Left blade

EL380-05
Sağ bleyd
Right blade



DARLING
EL384-01
18 cm



DARLING
EL384-02
18 cm



MEYERDING
EL386-00 25 x 40 mm
EL386-01 25 x 50 mm
EL386-02 25 x 60 mm
17 cm



EL390-00
17 cm



EL392-00 Sağ/Right
18 cm



EL394-00 Sol/Left
18 cm

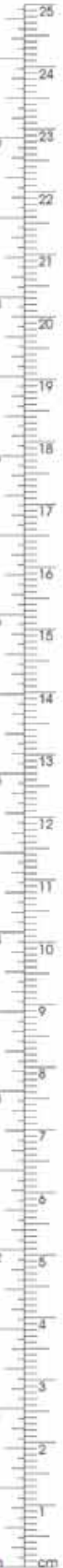



1/2

DE BAKEY
EL405-00
Kalça kemiği ekartörü, çocuk için
Femur retractor for children
10 cm



1/2

DE BAKEY
EL406-00
Kalça kemiği ekartörü
Femur retractor
14.5 cm



1/2

GELPI
EL408-00
Vajinal ekartör
Vaginal retractor
13.5 cm



1/2

RICHTER
EL412-00
17 cm



1/2

GELPI
EL409-00
Cilt ve vajinal ekartör
Skin and vaginal retractor
17.5 cm



1/2

JACKSON-BURROWS
EL415-00
Ekartör, künt/retractor, blunt
18.5 cm



1/2

JOLL (FRIEDMANN)
EL417-00
Tiroid ve vajinal ekartör
Thyroid and vaginal retractor
15.5 cm

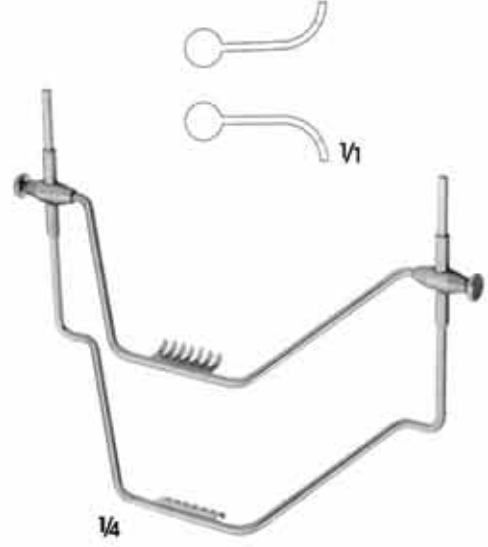

1/4

EL419-00
Tiroid ekartörü
Thyroid retractor



1/2

TROUSSEAU
ET040-01
Trakeal dilatör
Tracheal dilator
12 cm



1/2

LABORDE
ET041-01
Trakeal dilatör
Tracheal dilator
12.5 cm



1/2

LABORDE
ET042-01
Trakeal dilatör/Güçlü model
Tracheal dilator/Strong pattern
13.5 cm



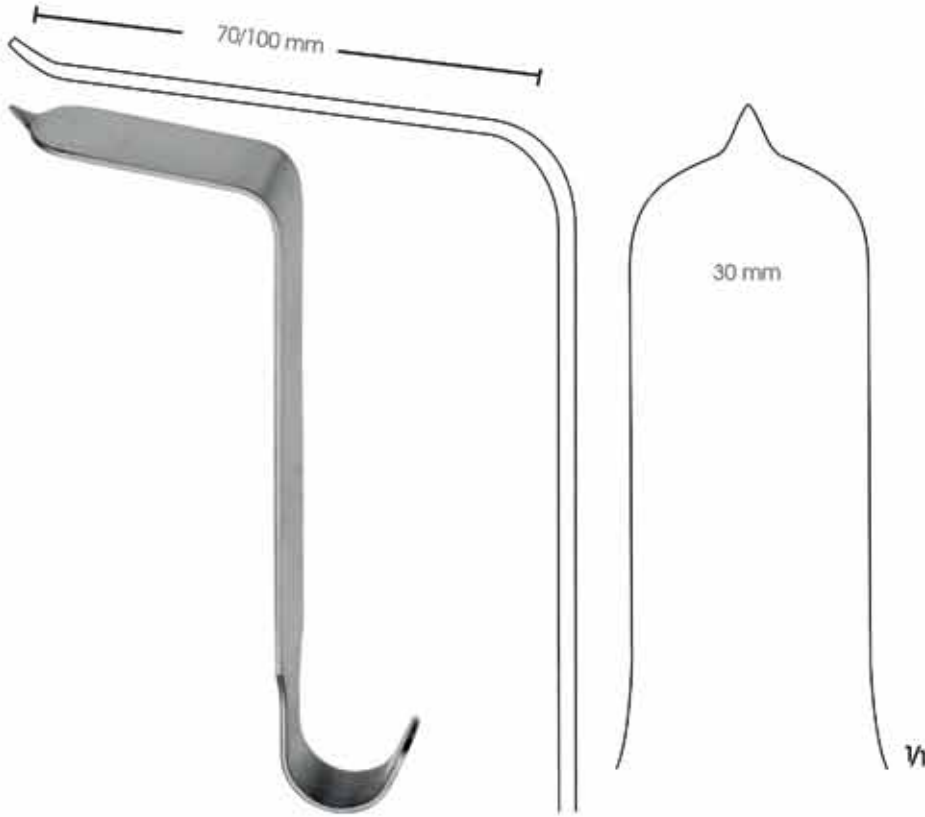

TAYLOR
EL482-00
Bleyd boyu/Blade Size 30 x 70 mm
18.5 cm
EL482-01
Bleyd boyu/Blade Size 30 x 100 mm
20 cm



BALLANTINE
EL484-03
32 x 90 mm
23 cm

TAYLOR-TURANTAN
EL482-03
20 x 68 x 150 mm



EL480-02
Sadece ekartör
Retractor only

TURANTAN
EL480-00 Komple/Complete
EL480-02
EL480-03-EL480-05-EL480-06-EL480-07



EL480-05 20 x 20 mm
EL480-06 30 x 20 mm
EL480-07 36 x 20 mm



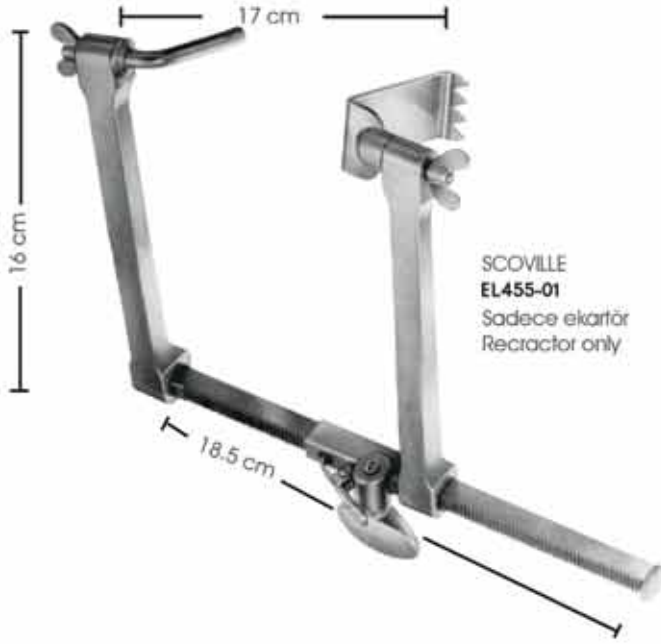

SCOVILLE
EL455-01
Sadece ekartör
Retractor only

SCOVILLE
EL455-06 Komple/Complete
EL455-01
EL455-40-EL455-45



SCOVILLE-HAVERFIELD
EL455-00
Sadece ekartör
Retractor only

SCOVILLE-HAVERFIELD
EL455-05 Komple/Complete
EL455-00
EL455-40-EL455-45



SCOVILLE
EL455-40 55 mm



SCOVILLE
EL455-45 63 x 25 mm
EL455-19 63 x 51 mm



TAYLOR
EL455-51 47 x 37 mm



TAYLOR
EL455-61 62 x 52 mm

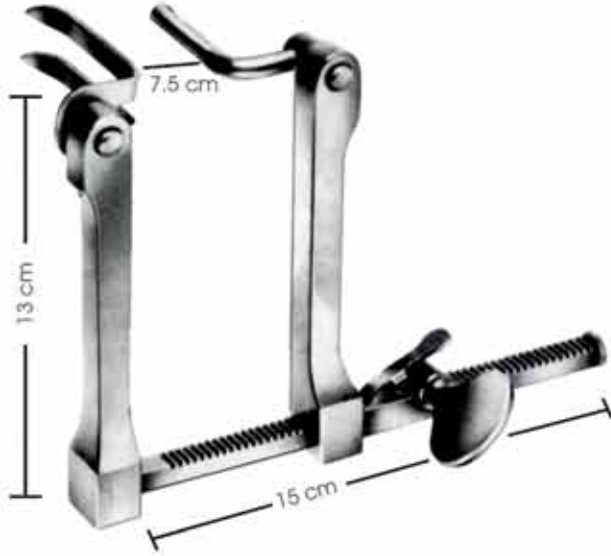

EL460-01
Sadece ekartör
Retractor only

CASPAR
EL460-00 Komple/Complete
EL460-01
EL463-02-EL463-15-EL463-25-EL463-35



EL463-00 38 mm
EL463-02 58 mm
Pimsiz/Without pins



EL463-10 32 x 22 mm
EL463-11 37 x 22 mm
EL463-12 42 x 22 mm
EL463-13 47 x 22 mm
EL463-14 52 x 22 mm
EL463-15 57 x 22 mm
EL463-16 62 x 22 mm
EL463-17 67 x 22 mm
Pimsiz/Without pins



EL463-20 32 x 37 mm
EL463-21 37 x 37 mm
EL463-22 42 x 37 mm
EL463-23 47 x 37 mm
EL463-24 52 x 37 mm
EL463-25 57 x 37 mm
EL463-26 62 x 37 mm
EL463-27 67 x 37 mm
Pimsiz/Without pins



EL463-30 32 x 52 mm
EL463-31 37 x 52 mm
EL463-32 42 x 52 mm
EL463-33 47 x 52 mm
EL463-34 52 x 52 mm
EL463-35 57 x 52 mm
EL463-36 62 x 52 mm
EL463-37 67 x 52 mm
Pimsiz/Without pins



Universal Ekartör
Universal Retractor



EL996-00P
Ekartörleri yerleştirme kolu
Retractor placing handle



EV644-00P
Tomavida/Screwdriver
15 cm



EL644-01 50 x 44 mm
EL644-02 50 x 54 mm
EL644-03 50 x 74 mm
EL644-04 50 x 89 mm

Spinal Ekartör
Spine Retractor

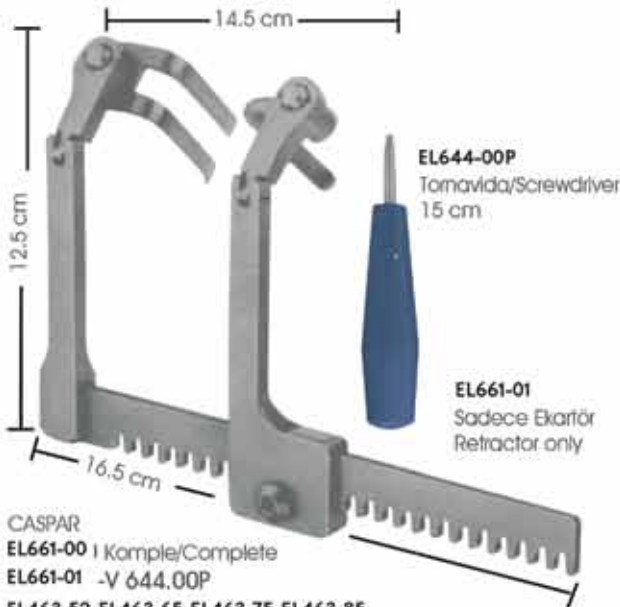

Universal spinal ekartör sistemi
Kendinden tutuculu Caspar universal spinal ekartörü, güvenli bir ekartasyona izin verir ve sökölüp takılabilir saplar sayesinde operasyon bölgesinde yer kazanır.

Universal spinal retractor system
The self-retaining Caspar universal spinal retractor permits safe retraction and saves in the operation area due to the removable handles.

	EL463-50 38 mm		EL463-52 58 mm		EL463-60 32 x 22 mm		EL463-70 32 x 37 mm		EL463-80 32 x 52 mm
	EL463-51 38 mm				EL463-61 37 x 22 mm		EL463-71 37 x 37 mm		EL463-81 37 x 52 mm
					EL463-62 42 x 22 mm		EL463-72 42 x 37 mm		EL463-82 42 x 52 mm
					EL463-63 47 x 22 mm		EL463-73 47 x 37 mm		EL463-83 47 x 52 mm
					EL463-64 52 x 22 mm		EL463-74 52 x 37 mm		EL463-84 52 x 52 mm
					EL463-65 57 x 22 mm		EL463-75 57 x 37 mm		EL463-85 57 x 52 mm
					EL463-66 62 x 22 mm		EL463-76 62 x 37 mm		EL463-86 62 x 52 mm
					EL463-67 67 x 22 mm		EL463-77 67 x 37 mm		EL463-87 67 x 52 mm
									EL463-88 67 x 52 mm

HARD COATED



EL486-02 40 mm EL486-03 45 mm EL486-04 50 mm EL486-05 55 mm EL486-06 60 mm EL486-07 65 mm EL486-09 75 mm EL486-11 85 mm



CASPAR
EL486-02-EL486-11

HARD COATED



EL487-05 35 mm EL487-06 40 mm EL487-07 45 mm EL487-08 50 mm EL487-09 55 mm EL487-10 60 mm EL487-11 65 mm EL487-13 75 mm EL487-15 85 mm



EL488-06 40 mm EL488-07 45 mm EL488-08 50 mm EL488-09 55 mm EL488-10 60 mm EL488-11 65 mm EL488-12 70 mm



EL487-01 Sadece ekartör
Retractor only

CASPAR
EL487-00 Komple/Complete
EL487-01
ED610-00
EL486-02-EL486-11
EL487-05-EL487-15
EL487-06-EL487-12

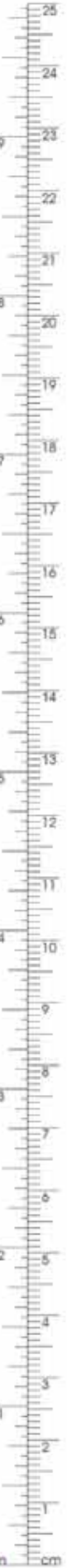

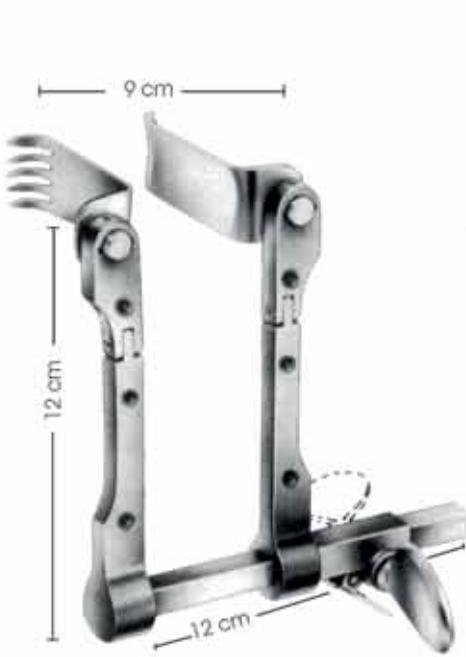

CASPAR
EL465-00
EL465-01 Sadece ekartör/Retractor only
(EL471-00-EL471-04)



CASPAR
EL467-00
EL467-01 Sadece ekartör/Retractor only
(EL472-00-EL472-05)



CASPAR
EL469-00
EL469-01 Sadece ekartör/Retractor only
(EL472-00-EL472-05)



EL470-00 40 x 23 mm
EL470-01 45 x 23 mm
EL470-02 50 x 23 mm
EL470-03 55 x 23 mm
EL470-04 60 x 23 mm



EL471-00 40 x 23 mm
EL471-01 45 x 23 mm
EL471-02 50 x 23 mm
EL471-03 55 x 23 mm
EL471-04 60 x 23 mm



EL472-00 40 x 23 mm
EL472-01 45 x 23 mm
EL472-02 50 x 23 mm
EL472-03 55 x 23 mm
EL472-04 60 x 23 mm
EL472-05 65 x 23 mm



EL470-06 40 x 25 mm
EL470-07 45 x 25 mm
EL470-08 50 x 25 mm
EL470-09 55 x 25 mm
EL470-10 60 x 25 mm



EL471-06 40 x 25 mm
EL471-07 45 x 25 mm
EL471-08 50 x 25 mm
EL471-09 55 x 25 mm
EL471-10 60 x 25 mm



EL472-08T 30 x 24 mm
EL474-09T 35 x 24 mm
EL472-10T 40 x 24 mm
EL474-11T 45 x 24 mm
EL472-12T 50 x 24 mm
EL474-13T 55 x 24 mm
EL472-14T 60 x 24 mm
EL474-15T 65 x 24 mm
EL472-16T 70 x 24 mm
EL474-17T 75 x 24 mm
Titanyum bleyd
Titanium blades



EL474-10T 25 x 24 mm
EL474-11T 30 x 24 mm
EL474-12T 35 x 24 mm
EL474-13T 40 x 24 mm
EL474-14T 45 x 24 mm
EL474-15T 50 x 24 mm
EL474-16T 55 x 24 mm
EL474-17T 60 x 24 mm
EL474-18T 65 x 24 mm
EL474-19T 70 x 24 mm
Titanyum bleyd
Titanium blades



EL474-20T 25 x 24 mm
EL474-21T 30 x 24 mm
EL474-22T 35 x 24 mm
EL474-23T 40 x 24 mm
EL474-24T 45 x 24 mm
EL474-25T 50 x 24 mm
EL474-26T 55 x 24 mm
EL474-27T 60 x 24 mm
EL474-28T 65 x 24 mm
EL474-29T 70 x 24 mm
Titanyum bleyd
Titanium blades



EL474-00 50 x 25 mm
EL474-01 60 x 25 mm



ED610-00
Bleyd tutma
pensi
Blade ejector
forceps
11.5 cm



EL465-05
Çift hareketli servikal ekartör
Double hinged cervical retractor



EL469-05
Çift hareketli karşı ekartör
Double hinged retractor used for
longitudinal retraction



EL467-05
Karşı ekartör
Counter retractor



EL470-50T 30 x 24 mm
EL470-51T 35 x 24 mm
EL470-52T 40 x 24 mm
EL470-53T 45 x 24 mm
EL470-54T 50 x 24 mm
EL470-55T 55 x 24 mm
EL470-56T 60 x 24 mm
EL470-57T 65 x 24 mm
EL470-58T 70 x 24 mm
Titanyum orta bleyd
Medial blades titanium



EL471-50T 30 x 24 mm
EL471-51T 35 x 24 mm
EL471-52T 40 x 24 mm
EL471-53T 45 x 24 mm
EL471-54T 50 x 24 mm
EL471-55T 55 x 24 mm
EL471-56T 60 x 24 mm
EL471-57T 65 x 24 mm
EL471-58T 70 x 24 mm
Titanyum yan bleyd
Lateral blades titanium



EL472-50T 35 x 24 mm
EL472-51T 40 x 24 mm
EL472-52T 45 x 24 mm
EL472-53T 50 x 24 mm
EL472-54T 55 x 24 mm
EL472-55T 60 x 24 mm
EL472-56T 65 x 24 mm
EL472-57T 70 x 24 mm
EL472-58T 75 x 24 mm
Titanyum künrt bleyd
Blunt blades titanium



EL474-50T 30 x 24 mm
EL474-51T 35 x 24 mm
EL474-52T 40 x 24 mm
EL474-53T 45 x 24 mm
EL474-54T 50 x 24 mm
EL474-55T 55 x 24 mm
EL474-56T 60 x 24 mm
EL474-57T 65 x 24 mm
EL474-58T 70 x 24 mm
Titanyum orta bleyd
Medial blades titanium



EL473-50T 30 x 24 mm
EL473-51T 35 x 24 mm
EL473-52T 40 x 24 mm
EL473-53T 45 x 24 mm
EL473-54T 50 x 24 mm
EL473-55T 55 x 24 mm
EL473-56T 60 x 24 mm
EL473-57T 65 x 24 mm
EL473-58T 70 x 24 mm
Titanyum yan bleyd
Lateral blades titanium



EL475-50T 35 x 24 mm
EL475-51T 40 x 24 mm
EL475-52T 45 x 24 mm
EL475-53T 50 x 24 mm
EL475-54T 55 x 24 mm
EL475-55T 60 x 24 mm
EL475-56T 65 x 24 mm
EL475-57T 70 x 24 mm
EL475-58T 75 x 24 mm
Titanyum künrt bleyd
Blunt blades titanium



EL476-50T 25 x 19 mm
EL476-51T 30 x 19 mm
EL476-52T 35 x 19 mm
EL476-53T 40 x 19 mm
EL476-54T 45 x 19 mm
EL476-55T 50 x 19 mm
EL476-56T 55 x 19 mm
EL476-57T 60 x 19 mm
Titanyum dişli bleyd
Teeth blades titanium



EL477-50T 25 x 19 mm
EL477-51T 30 x 19 mm
EL477-52T 35 x 19 mm
EL477-53T 40 x 19 mm
EL477-54T 45 x 19 mm
EL477-55T 50 x 19 mm
EL477-56T 55 x 19 mm
EL477-57T 60 x 19 mm
Titanyum künrt bleyd
Blunt blades titanium



ET995-00P
Bleyd tutucu elçek
Handle for blades with side load
attachment





CLOWARD
EL490-01
Sadece ekartör
Retractor only
25 cm



CLOWARD
EL491-00
Sadece ekartör
Retractor only
15 cm

CLOWARD
EL490-00 Komple/Complete
EL490-01
EL490-05-EL491-09

CLOWARD
EL491-01 Komple/Complete
EL491-00
EL491-05-EL491-06-EL491-07
EL491-08-EL491-09





CLOWARD
EL494-00
15.5 cm



CLOWARD
EL495-00
13.5 cm



INGE
EL497-00
17 cm

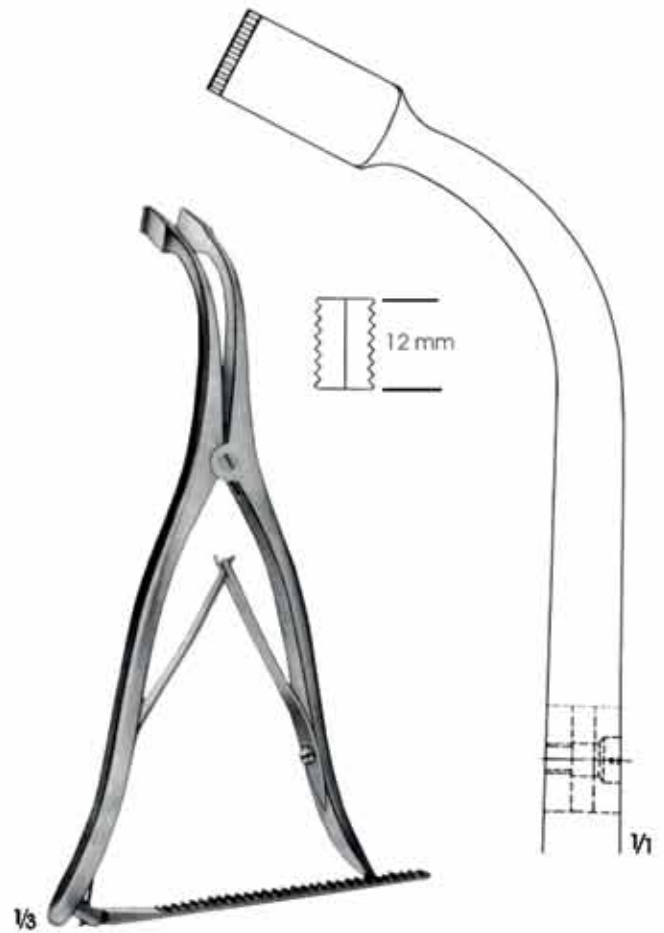

INGE
EL498-00
27.5 cm





BABY-COLLIN

EL500-00 Komple/Complete

EL500-01 Sadece ekartör
Retractor only

EL500-10 18 x 42 mm bleyd çift/blades pair

EL500-11 28 x 42 mm bleyd çift/blades pair



COLLIN

EL501-00 Komple/Complete

EL501-01 Sadece ekartör
Retractor only

EL560-00 Yan bleyd çift

Lateral blades pair

EL503-06 13.5 cm
EL503-07 16 cm



COLLIN

EL503-01-EL503-03

Sadece ekartör
Retractor only

Yan bleyd (çift)
Lateral blades (pair)

Orta bleyd
Center blade

EL503-01
EL503-06

EL503-02
EL503-07

EL503-03
EL503-07

EL560-00
37 x 62 mm

EL560-01
37 x 80 mm

EL560-02
37 x 98 mm

EL580-03
54 x 55 mm

EL580-04
54 x 67 mm

EL580-05
52 x 76 mm



COLLIN
EL502-00-EL502-01

Sadece ekartör
Retractor only
Yan bleyd (çift)
Lateral blades (pair)
Orta bleyd
Center blade

EL502-00	EL502-01
EL502-04	EL502-04
EL560-04	EL560-03
48 x 59 mm	61 x 80 mm
EL580-00	EL580-00
63 x 74 mm	63 x 74 mm



RICARD
EL506-00-EL506-01

Sadece ekartör
Retractor only
Yan bleyd (çift)
Lateral blades (pair)
Orta bleyd
Center blade

EL506-00	EL506-01
EL506-04	EL506-04
EL560-05	EL560-06
58 x 80 mm	72 x 84 mm
EL580-10	EL580-11
54 x 70 mm	72 x 90 mm





ROBIN-MASSE
EL505-00
Komple/Complete

Sadece ekartör Retractor only	EL505-01
Yan bleyd (çift) Lateral blades (pair)	EL560-00 37 x 62 mm
Orta bleyd Center blade	EL580-08 38 x 68 mm



HOLZBACH
EL508-00
Komple/Complete

Sadece ekartör Retractor only	EL508-01
Yan bleyd (çift) Lateral blades (pair)	EL560-07 59 x 80 mm
Orta bleyd Center blade	EL580-16 74 x 82 mm



EL560-04 48 x 59 mm
EL560-05 58 x 80 mm
EL560-06 72 x 84 mm
Yan bıyık (çift)
Lateral blades (pair)

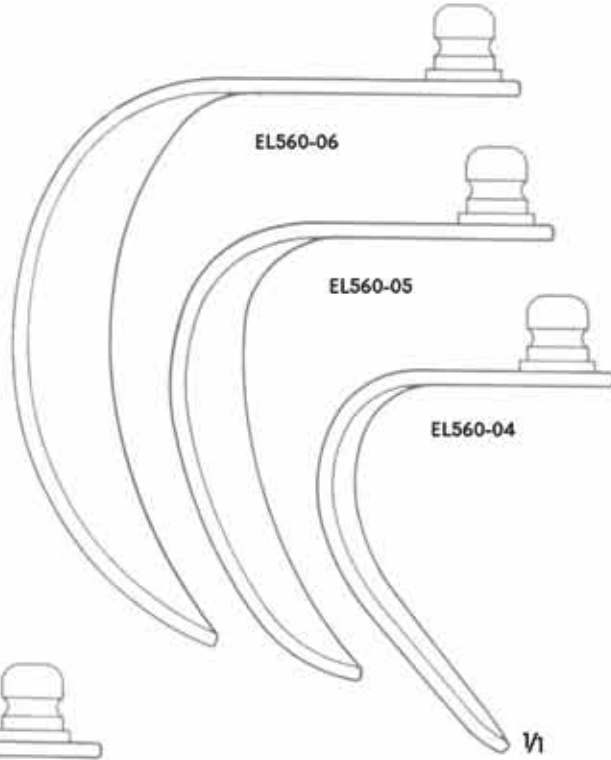

EL560-07 59 x 80 mm
Yan bıyık (çift)
Lateral blades (pair)



EL560-00 37 x 62 mm
EL560-01 37 x 80 mm
EL560-02 37 x 98 mm
Yan bıyık (çift)
Lateral blades (pair)

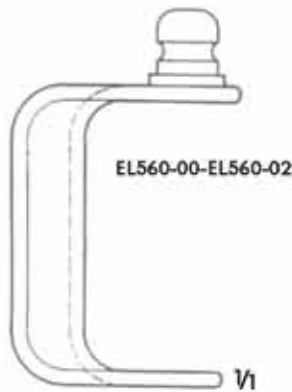

EL560-03 61 x 80 mm

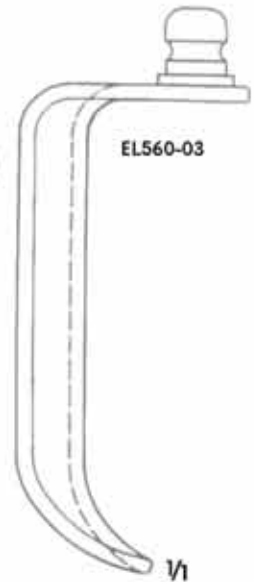



GOSSET
EL520-00
Bleyd/Blades 38 mm

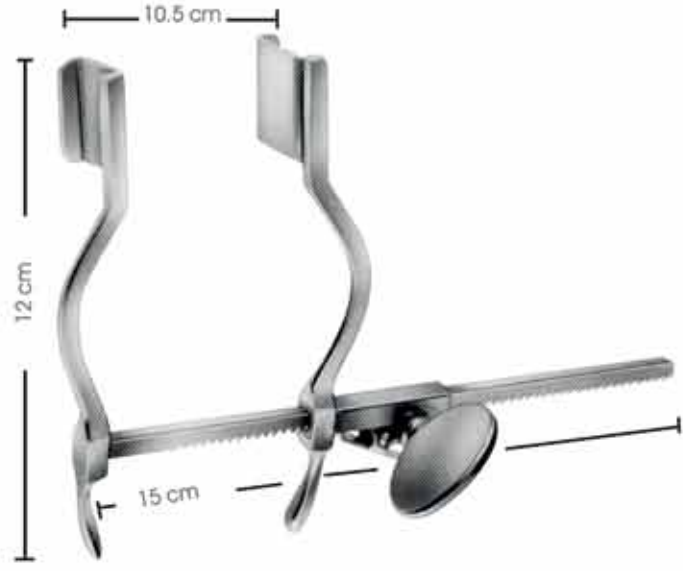

HERTZLER
EL522-00
Bleyd/Blades
20 x 25 mm



BALFOUR-BABY
EL524-00
Yan bleyd/Lateral blades 27 mm
Orta bleyd L 580.20
Center blade 21 x 24 mm



GOSSET
EL525-00
Bleyd/Blades 55 mm



GOSSET
EL528-00
Yan bıyıld/Lateral blades 58 mm
Orta bıyıld L 580.22
Center blade 59 x 57 mm

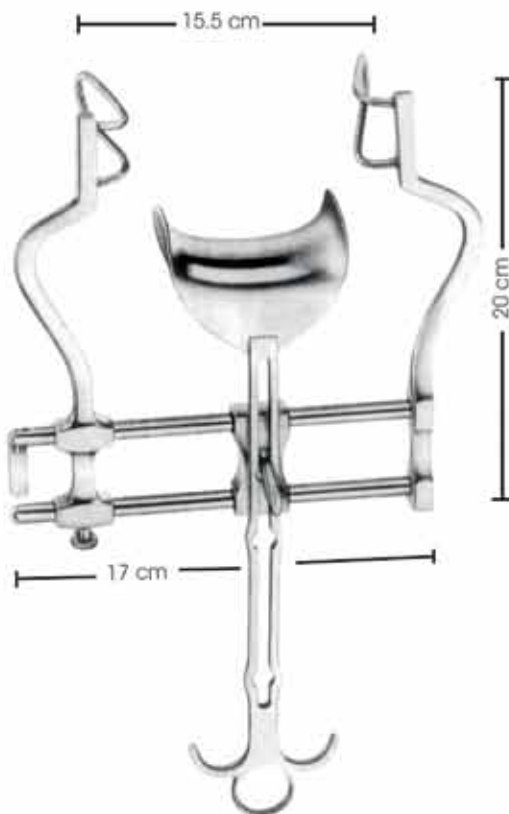

BALFOUR
EL530-00
Yan bıyıld/Lateral blades 60 mm
Orta bıyıld L 580.25
Center blade 47 x 80 m

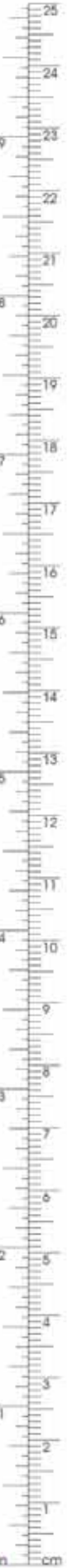

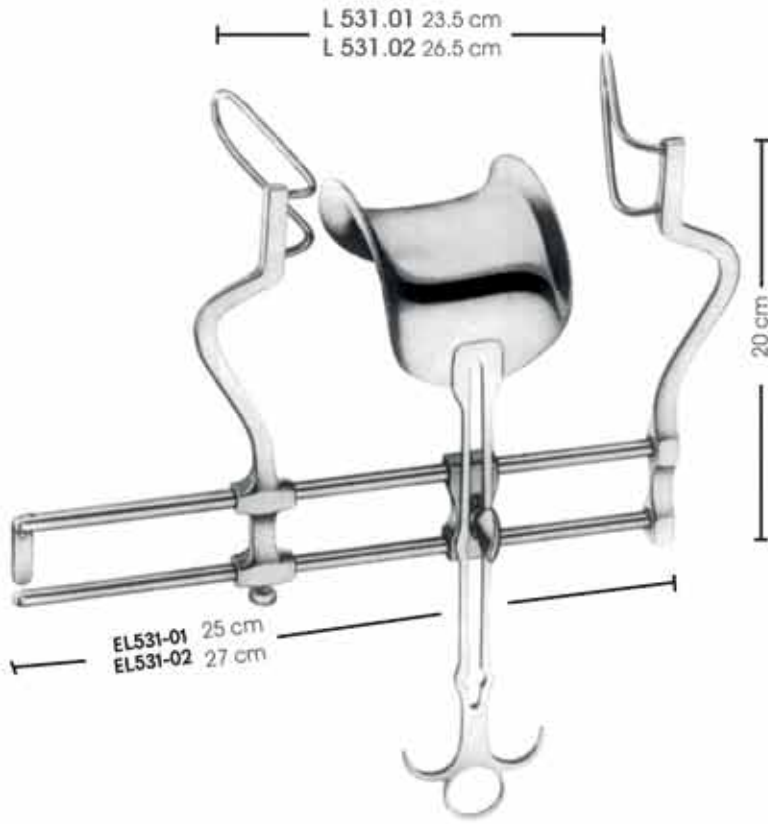

BALFOUR
EL531-01-EL531-02

	EL531-01	EL531-02
Yan bleyd Lateral blades	60 mm	90 mm
Orta bleyd Center blade	EL580-26 62 x 76 mm	EL580-27 80 x 80 mm

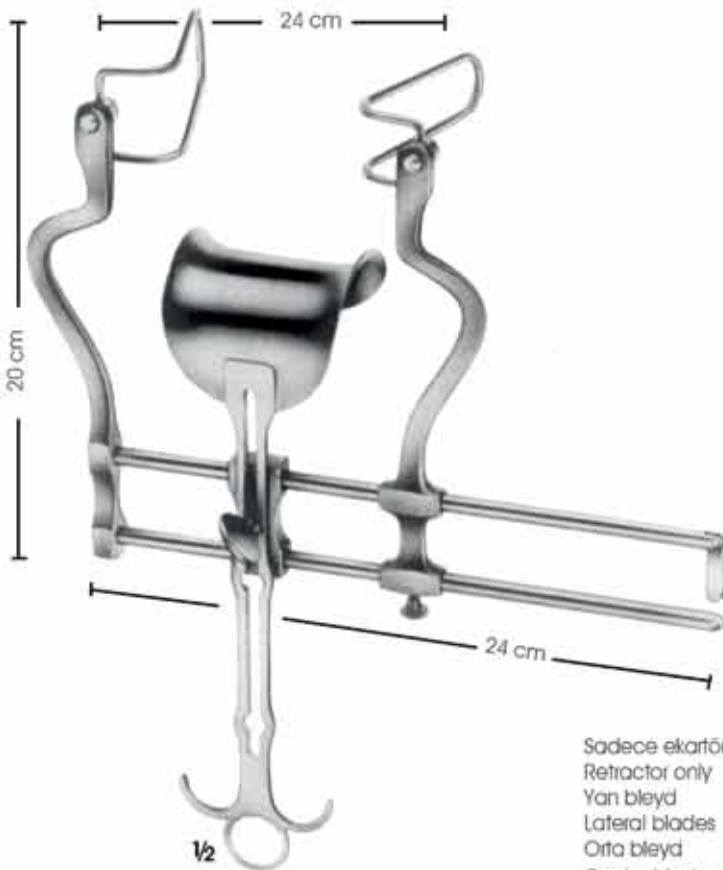

EL560-10 50 mm
EL560-11 60 mm
EL560-12 75 mm
EL560-13 90 mm
Yan Bleyd/Lateral Blades

BALFOUR
EL534-00-EL534-03
Komple/Complete

	EL534-00 EL534-20	EL534-01 EL534-20	EL534-02 EL534-20	EL534-03 EL534-20
Sadece ekartör Retractor only				
Yan bleyd Lateral blades	EL560-10 50 mm	EL560-11 60 mm	EL560-12 75 mm	EL560-13 90 mm
Orta bleyd Center blade	EL580-25 47 x 80 mm	EL580-26 62 x 76 mm	EL580-27 80 x 80 mm	EL580-27 80 x 80 mm

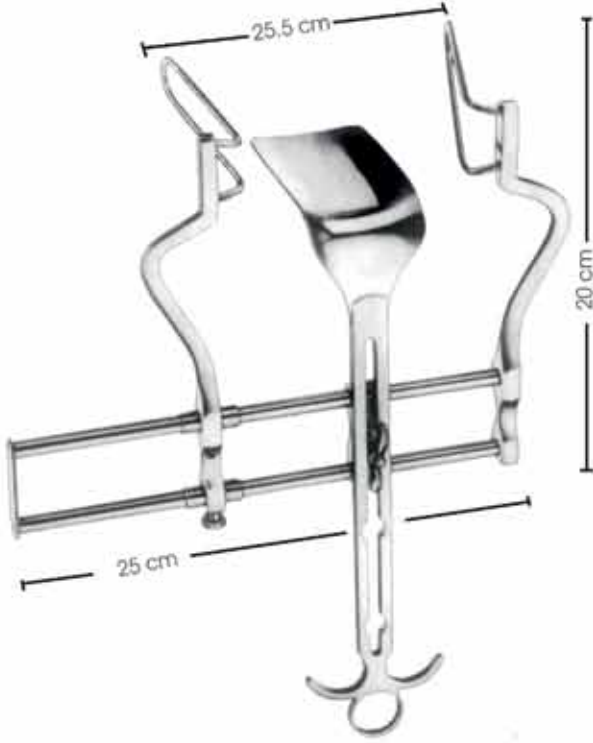

BALFOUR
EL532-01
Yan bleyd 105 mm
Lateral blades
Orta bleyd **EL580-23**
Center blade 107 x 59 mm



EL580-30
Orta bleyd
Center blade
54 x 80 mm



EL580-40
Orta bleyd, prostatektomi
için kanallı 75 x 80 mm
Center blade, slotted for
retropubie prostatectomy
75 x 80 mm



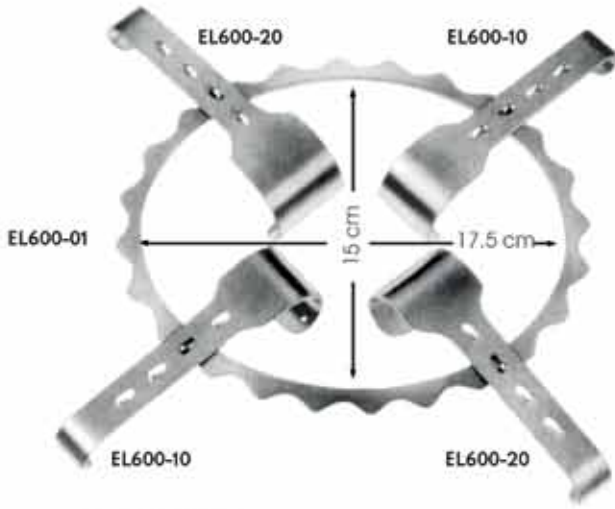

DENNIS-BROWNE
EL600-00
Komple/Complete

EL600-01 175 x 150 mm Çember/Frame
EL600-10 40 x 30 mm 2 adet bleyd/2 each blades
EL600-20 40 x 40 mm 2 adet bleyd/2 each blades



EL600-30
1 adet bleyd
1 each blade
20 x 30 mm



EL600-32
1 adet bleyd
1 each blade
20 x 40 mm

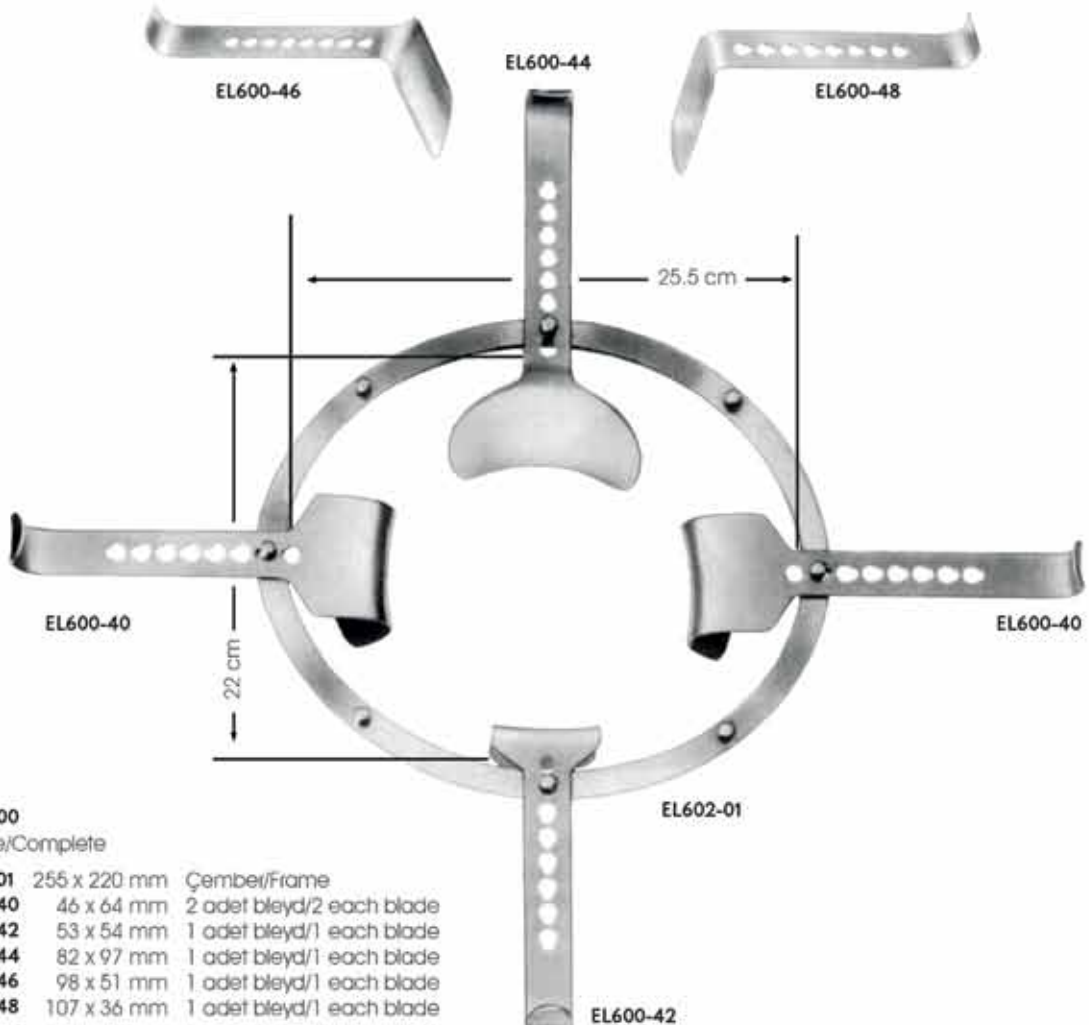

SEMM
EL602-00
Komple/Complete

EL602-01 255 x 220 mm Çember/Frame
EL602-40 46 x 64 mm 2 adet bleyd/2 each blade
EL602-42 53 x 54 mm 1 adet bleyd/1 each blade
EL602-44 82 x 97 mm 1 adet bleyd/1 each blade
EL602-46 98 x 51 mm 1 adet bleyd/1 each blade
EL602-48 107 x 36 mm 1 adet bleyd/1 each blade

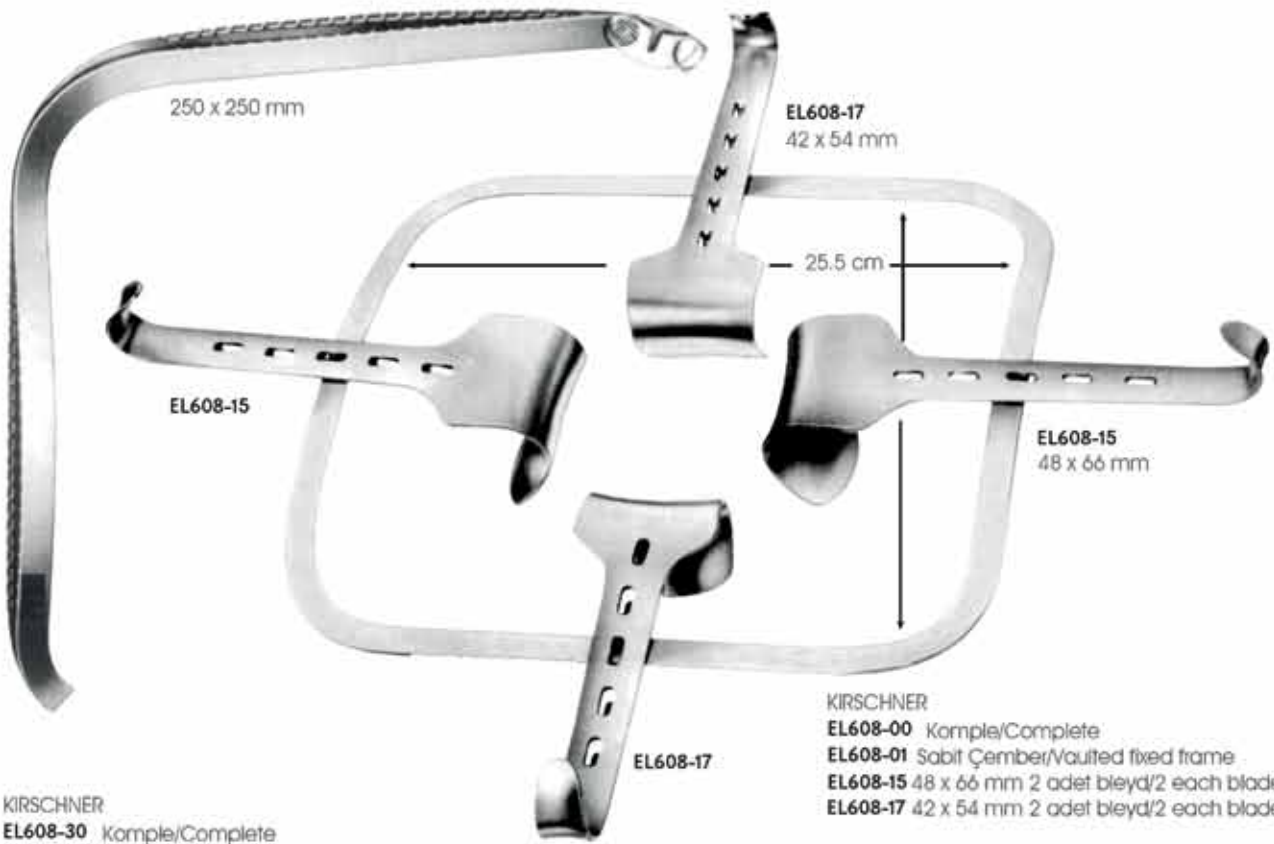

KIRSCHNER

EL608-30 Komple/Complete

EL608-31 Katlanabilir/Holding frame

EL608-15 48 x 66 mm 2 adet bıyık/2 each blades

EL608-17 42 x 54 mm 2 adet bıyık/2 each blades

KIRSCHNER

EL608-00 Komple/Complete

EL608-01 Sabit Çember/Vaulted fixed frame

EL608-15 48 x 66 mm 2 adet bıyık/2 each blades

EL608-17 42 x 54 mm 2 adet bıyık/2 each blades

EL608-04 275 x 355 mm

Büyük ölçekli çember

Frame only, over-sized

EL608-06 295 x 275 mm

Sadece Çember/Frame only



KIRSCHNER
EL608-50
64 x 80 mm

KIRSCHNER-BALFOUR
EL608-52
80 x 82 mm

KIRSCHNER
EL608-54 90 x 69 mm
EL608-56 95 x 95 mm
EL608-58 78 x 58 mm

KIRSCHNER
EL608-64 108 x 42 mm
EL608-66 91 x 55 mm
EL608-68 120 x 55 mm

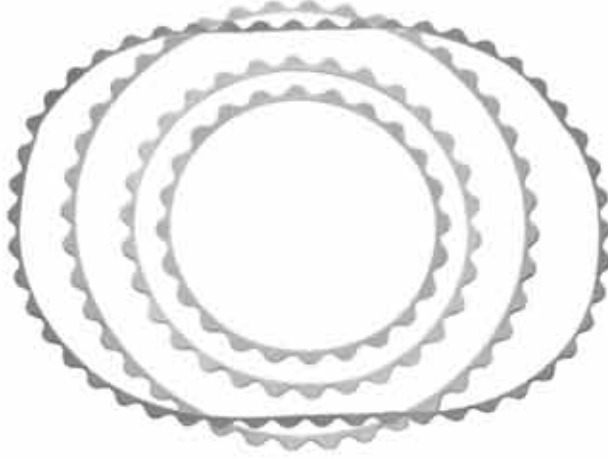

TURNER-WARWICK

EL605-01 Ø 18 cm

EL605-02 Ø 23 cm

EL605-03 Ø 30,5 cm

Ekartör çemberi, yuvarlak
Retractor frame, round

EL605-10

Ekartör çemberi, oval
Retractor frame, oval
457 x 330 mm



TURNER-WARWICK

EL605-00 Komple/Complete

EL605-01 1 adet/1 each

EL605-03 1 adet/1 each

EL605-30 2 adet/2 each

EL605-40 2 adet/2 each

EL605-22 2 adet/2 each

EL605-25 2 adet/2 each

EL605-27 2 adet/2 each

EL605-28 2 adet/2 each

EL605-20 2 adet/2 each



EL605-20
13 mm



EL605-22
51 x 38 mm



EL605-25
76 x 60 mm



EL605-27
89 x 60 mm



EL605-28
114 x 60 mm



EL605-30
Bükülebilir/Malleable
76 x 19 mm



EL605-33
Bükülebilir/Malleable
102 x 38 mm



EL605-35
Bükülebilir/Malleable
89 x 57 mm



EL605-40
Bükülebilir/Malleable
114 x 57 mm





**GOLIGHER
EL529-00**

Komple/Complete
Orta bleyd/Center blade 51 mm
Orta bleyd/Center blade 102 mm
Yan bleyd(bir çift)/Lateral blades(pair) 51 mm
Yan bleyd(bir çift)/Lateral blades(pair) 102 mm



EL604-01
Sadece ekartör
Retractor only

O'SULLIVAN-O' CONNOR
EL604-00 Komple/Complete
EL604-01
EL604-10 (2 adet) **EL604-11** (1 adet)



O'SULLIVAN-O' CONNOR
EL604-10
Küçük bleyd/Small blade



O'SULLIVAN-O' CONNOR
EL604-11
Buyuk bleyd/Large blade



EL403-06
60 x 50 mm



EL403-05
40 x 35 mm



EL515-05
57 x 25 mm



- EL403-00 Komple/Complete
Popliteal Ekartör/Popliteal Retractor
EL403-03 Sadece ekartör/Retractor only
EL403-06 Bleyd, künf 60 x 50 mm
Blades, blunt 60 x 50 mm
EL403-05 Bleyd, yarı şivli, 40 x 35 mm
Blades, semi-sharp 40 x 35 mm



EL515-06
82 x 25 mm

- MILLIN
EL515-00 Komple/Complete
Mesane Ekartörü/Bladder Retractor
EL515-02 Sadece ekartör/Retractor only
EL515-05 Bleyd 57 x 25 mm/Blades 57 x 25 mm
EL515-06 Bleyd 82 x 25 mm/Blades 82 x 25 mm
EL515-11 Orta bleyd 105 x 45 mm
Center blade 105 x 45 mm



- LEGUEU
EK723-00
Mesane spatulası
Bladder spatula
26 cm

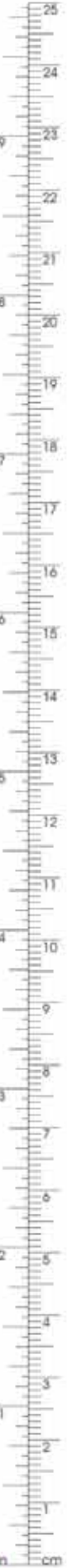



ALLENBERG
EL903-01
Sadece ekartör
Retractor only

ALLENBERG
EL903-00
İliak ekartörü komple
Iliaca retractor complete
L 903.01 Sadece ekartör/Retractor only
L 903.03T Yan Bleyd/Lateral Blade 30 x 30 mm
L 903.04T Orta Bleyd/Medial Blade 90 x 60 mm



ALLENBERG
EL903-03T
Yan Bleyd/Lateral Blade
Titanyum/Titanium
30 x 30 mm



ALLENBERG
EL903-04T
Orta Bleyd/Medial Blade
Titanyum/Titanium
90 x 60 mm



ALLENBERG
EL582-00
Bleyd değiřtirmek için penset
Forceps for changing the blades
13 cm

Arteria İliak communis'e optimum yaklaşım için ekartör.

Bleydleri titanyumdan yapılmıştır ve bu sebeple x ışını geçirgendir. Büyük ekartör bleydi operasyon esnasında kademeli olarak ayarlanabilir. Ekartör bleydlerin kolaylıkla değiřtirilebiliyor olması ekartör sisteminin sağ taraftan ve sol taraftan kullanımını sağlar.

Retractor system for optimal approach to the arteria iliaca communis.

The retractor blades are made out of titanium and therefore they are radiotransparent. The big medial retractor blade can be gradually adjusted during the operation. Because of the blades which are easy to exchange the retractor system can be used for the left and the right side.

Sternum ekartörü veya mamaria interna'nın operasyonuna hazırlanması için kullanılır.
Used as sternum retractor or used for preparation of the arteria mammaria interna.

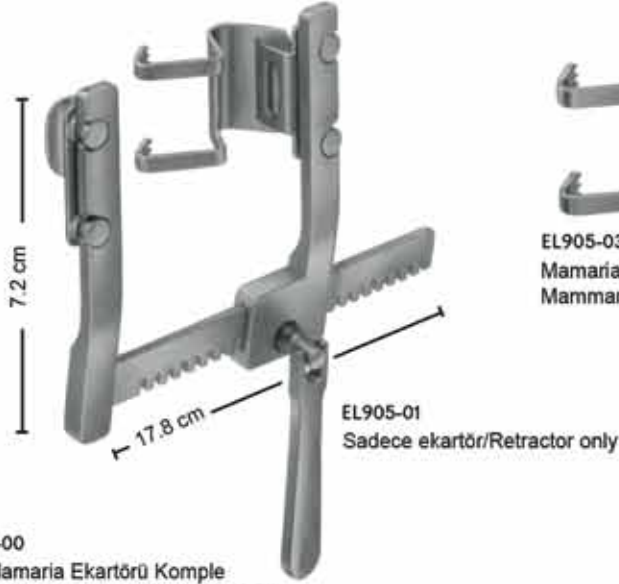

EL905-01
Sadece ekartör/Retractor only



EL905-03
Mamaria Bleyd Komple
Mammaria Blade Complete



EL905-04
1 çift sternum bleyd
1 Pair sternum blades
30 x 50 mm

- EL905-00
Mini Mamaria Ekartörü Komple
Mini Mammaria Retractor Complete
EL905-01 Sadece ekartör/Retractor only
EL905-03 Mamaria Bleyd Komple/Mammaria Blade Complete
EL905-04 1 çift sternum bleyd/1 Pair sternum blades 30 x 50 mm

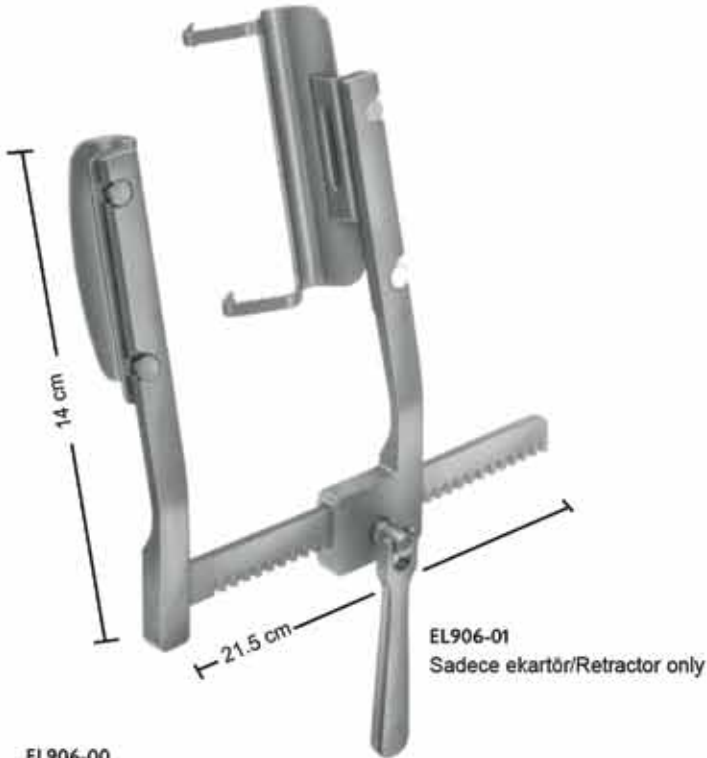

EL906-01
Sadece ekartör/Retractor only



EL906-03
Mamaria Bleyd Komple
Mammaria Blade Complete



EL906-04
1 çift sternum bleyd
1 Pair sternum blades
30 x 100 mm



EL906-05
1 çift sternum bleyd
1 Pair sternum blades
40 x 100 mm

- EL906-00
Mamaria Ekartörü Komple
Mammaria Retractor Complete
EL906-01 Sadece ekartör/Retractor only
EL906-03 Mamaria Bleyd Komple/Mammaria Blade Complete
EL906-04 1 çift sternum bleyd/1 Pair sternum blades 30 x 100 mm
EL906-05 1 çift sternum bleyd/1 Pair sternum blades 40 x 100 mm



MUENSTER

EL509-01

Sekizgen çentik çubuğu /
Octangular notch rod



MUENSTER

EL509-05

Universal bağlantı aparatı /
Universal connecting clamp



EL509-00

Takım ekartör sistemi /
Complete retractor system



EL509-06

Ekartör / Retractor



**EL509-02**

Ekartör bıyık takımı /
Barre retractor blades
2 adet 50 X 70 mm /
2 pieces 50X 7 mm

**EL509-03**

Lateral bıyık bükülebilir /
Lateral blade malleable
190 X 50 mm

**EL509-04**

Orta bıyık /
Center blade
54 X 70 mm
23,5 cm

**EL509-07**

Işık destek aparatı /
Barre cold light support



EGC

Genel Cerrahi
General Surgery



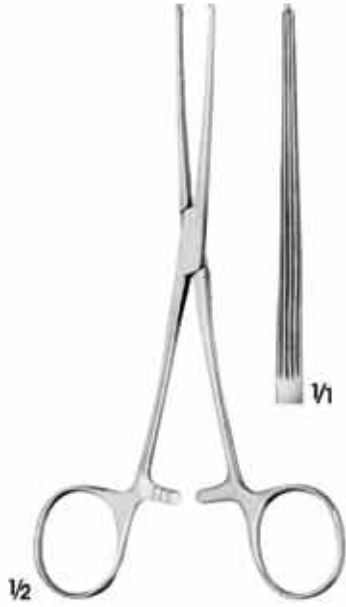

ALLEN
EG330-00
15.5 cm

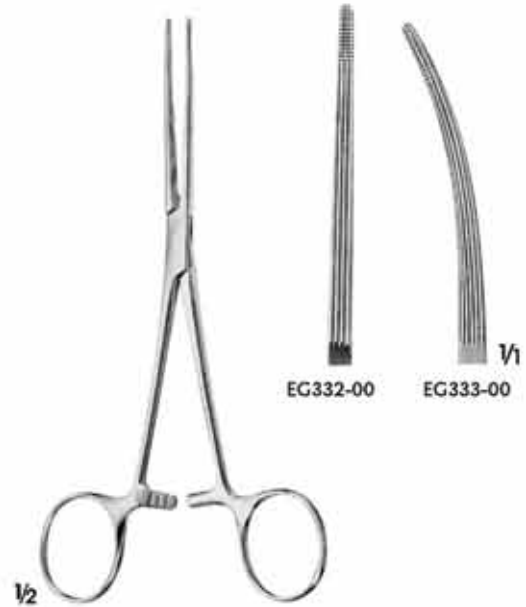

BAINBRIDGE
EG332-00-EG333-00
15.5 cm



DOYEN
EG335-00-EG336-00
Elastik/Elastic
16.5 cm

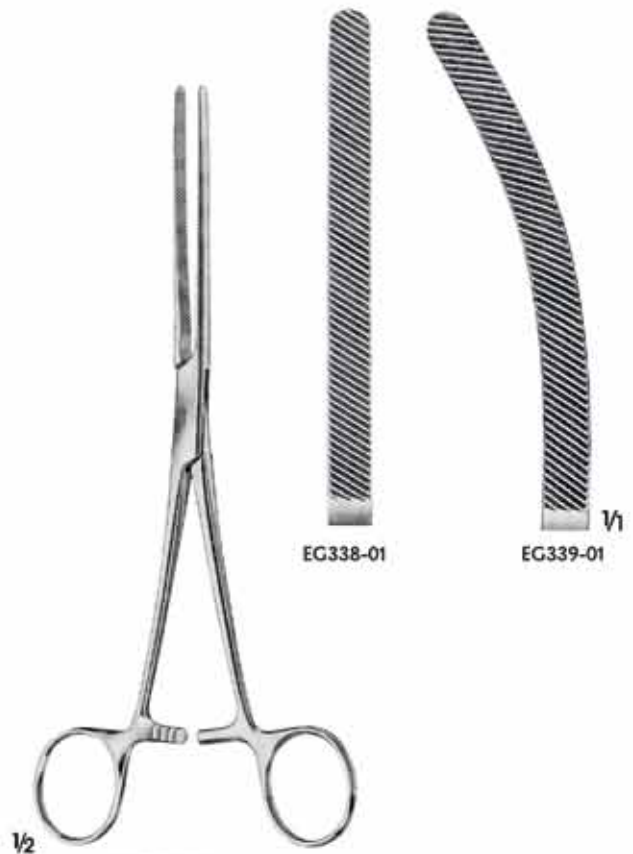

HARTMANN
EG338-01-EG339-01
Yumuşak ve elastik
Soft and elastic
20 cm



BABY-KOCHER
EG345-00-EG346-00
Çocuklar İçin/For children
Çok elastik/Very elastic
13 cm

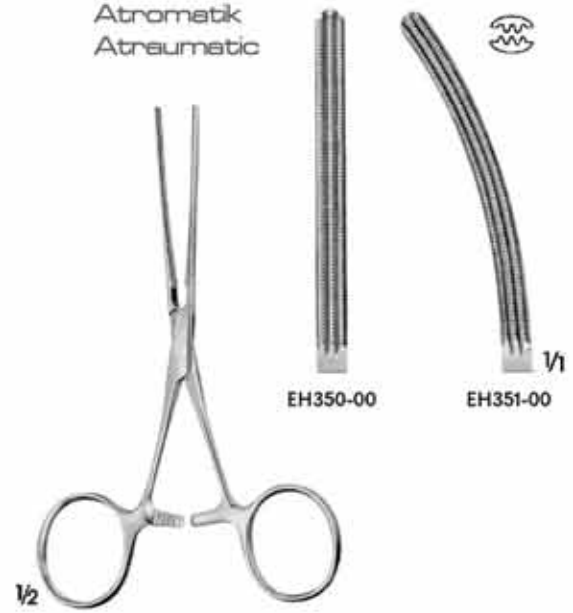

BABY-KOCHER
EH350-00-EH351-00
Çocuklar İçin/For children
Yumuşak ve elastik/ Soft and elastic
13 cm

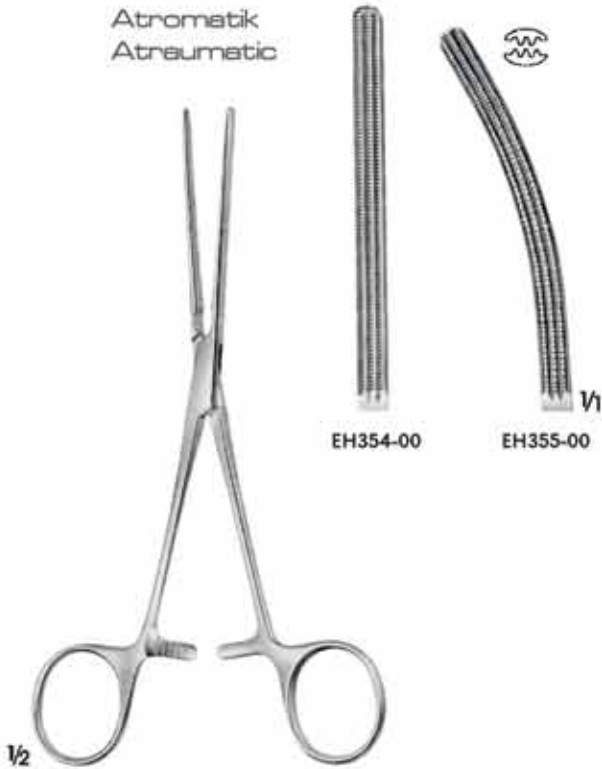

DOYEN
EH354-00-EH355-00
Yumuşak ve elastik
Soft and elastic
17 cm

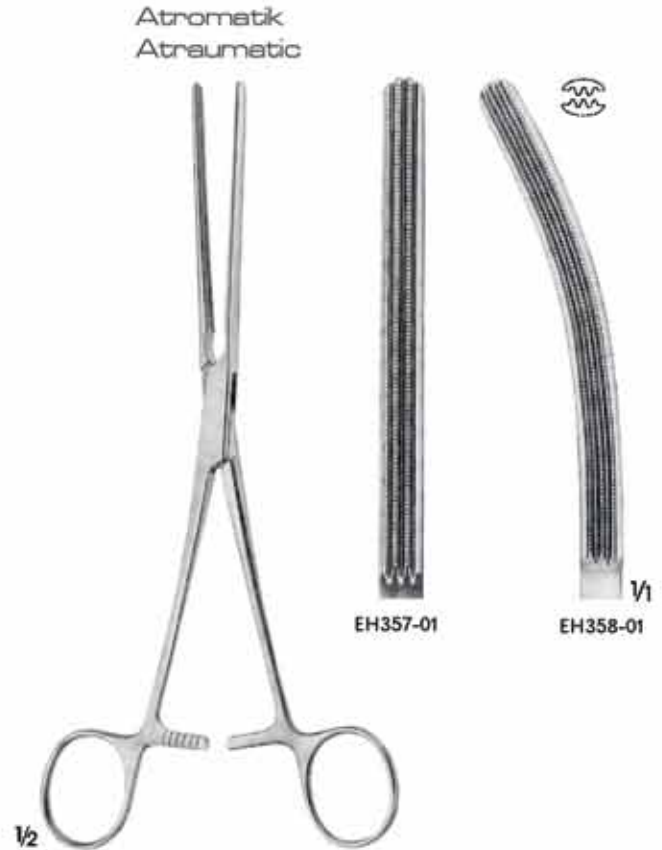

HARTMANN
EH357-01-EH358-01
Yumuşak ve elastik
Soft and elastic
20 cm



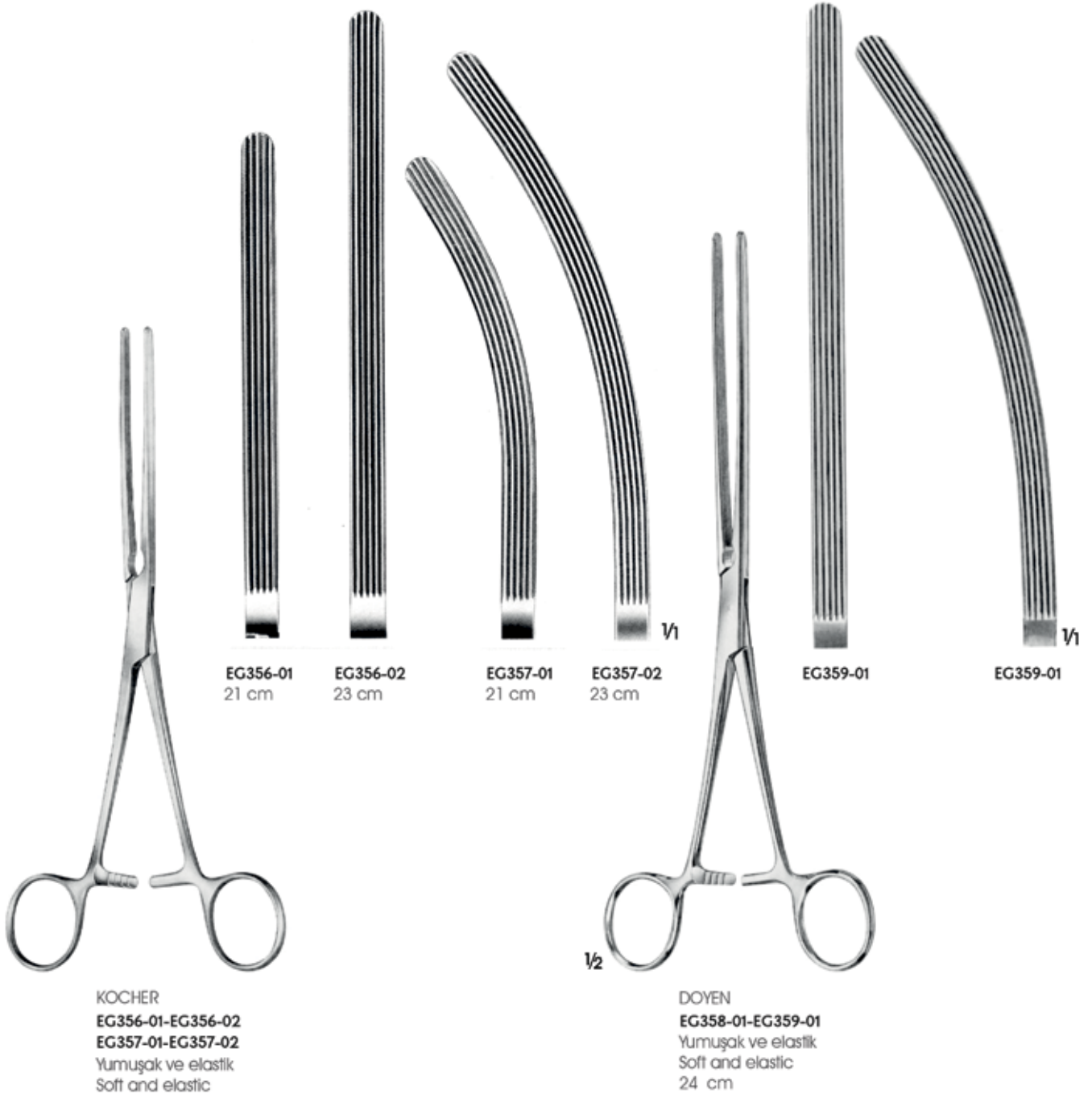

Atromatik
Atraumatic



EH365-02

EH366-02

1/2

DOYEN
EH365-02-EH366-02
Yumuşak ve elastik
Soft and elastic
23 cm



EG368-02

EG369-02

1/2

DOYEN
EG368-02-EG369-02
Yumuşak ve elastik
Soft and elastic
23.5 cm



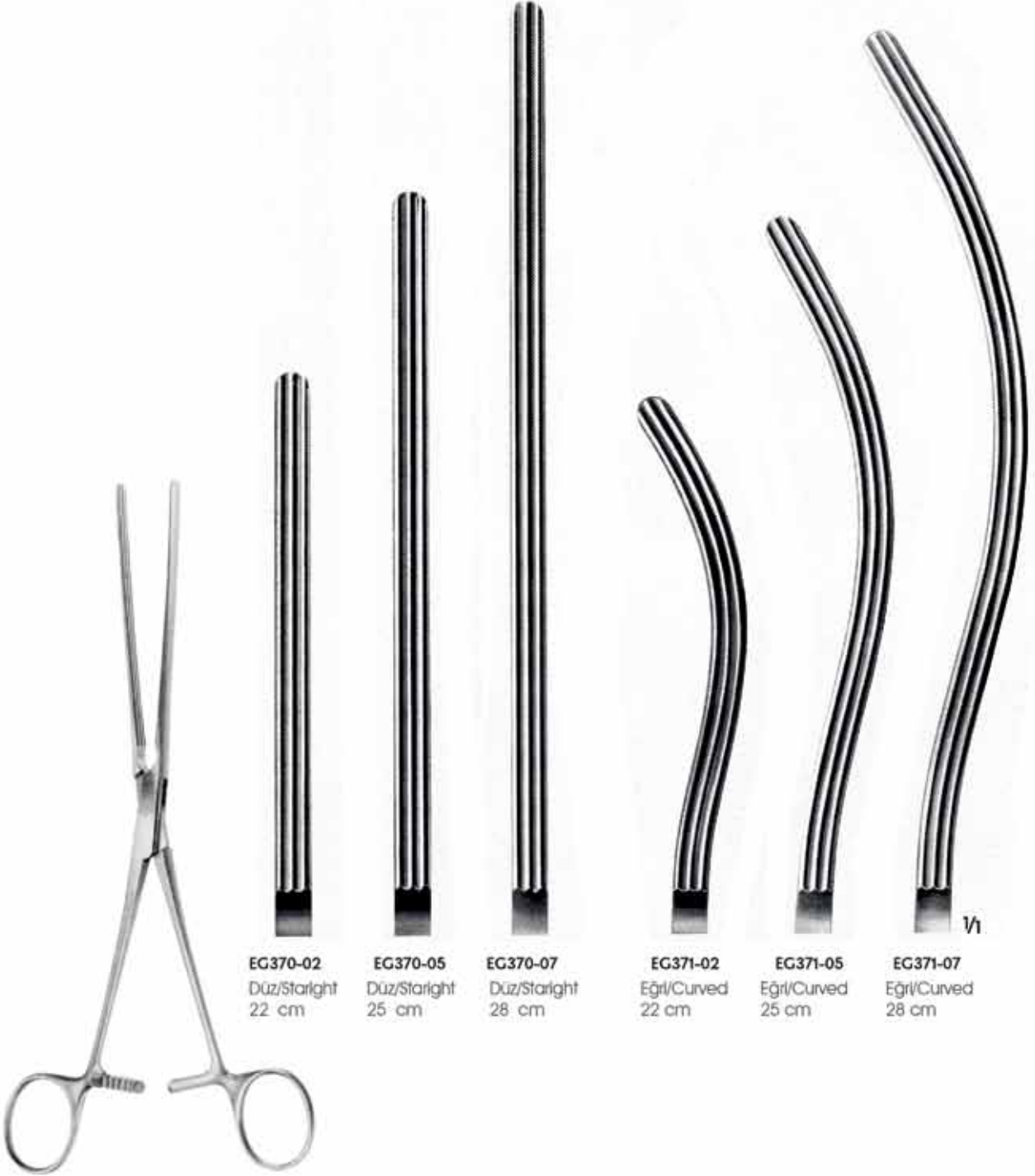

EG370-02
Düz/Straight
22 cm

EG370-05
Düz/Straight
25 cm

EG370-07
Düz/Straight
28 cm

EG371-02
Eğri/Curved
22 cm

EG371-05
Eğri/Curved
25 cm

EG371-07
Eğri/Curved
28 cm

KOCHER
EG370-02-EG370-07
EG371-02-EG371-07
Yumuşak ve elastik
Soft and elastic



KOCHER
EG360-02-EG360-07
EG361-02-EG361-07
Yumuşak ve elastik
Soft and elastic

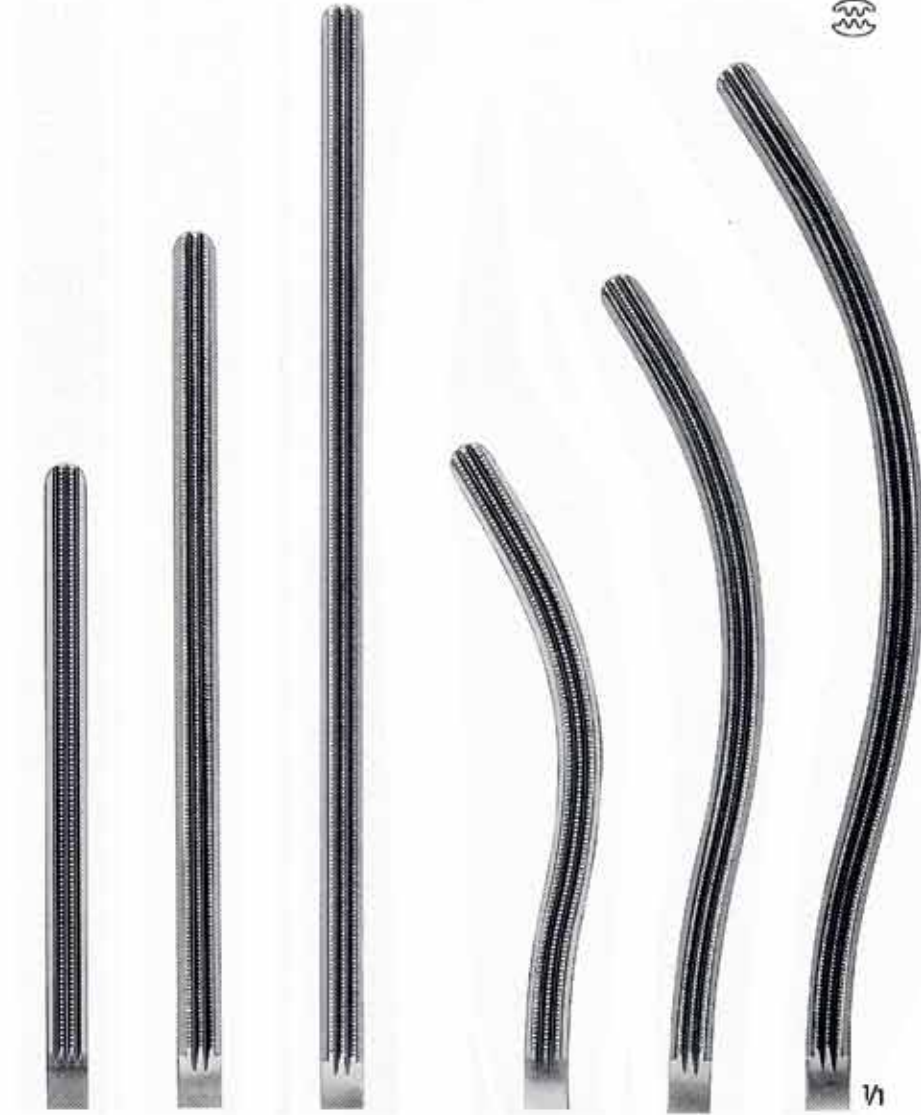

EG360-02
Düz/Straight
22 cm

EG360-05
Düz/Straight
25 cm

EG360-07
Düz/Straight
28 cm

EG361-02
Eğil/Curved
22 cm

EG361-05
Eğil/Curved
25 cm

EG361-07
Eğil/Curved
28 cm



Atrometik
Atraumatic



EG375-02



EG376-02



EH380-02

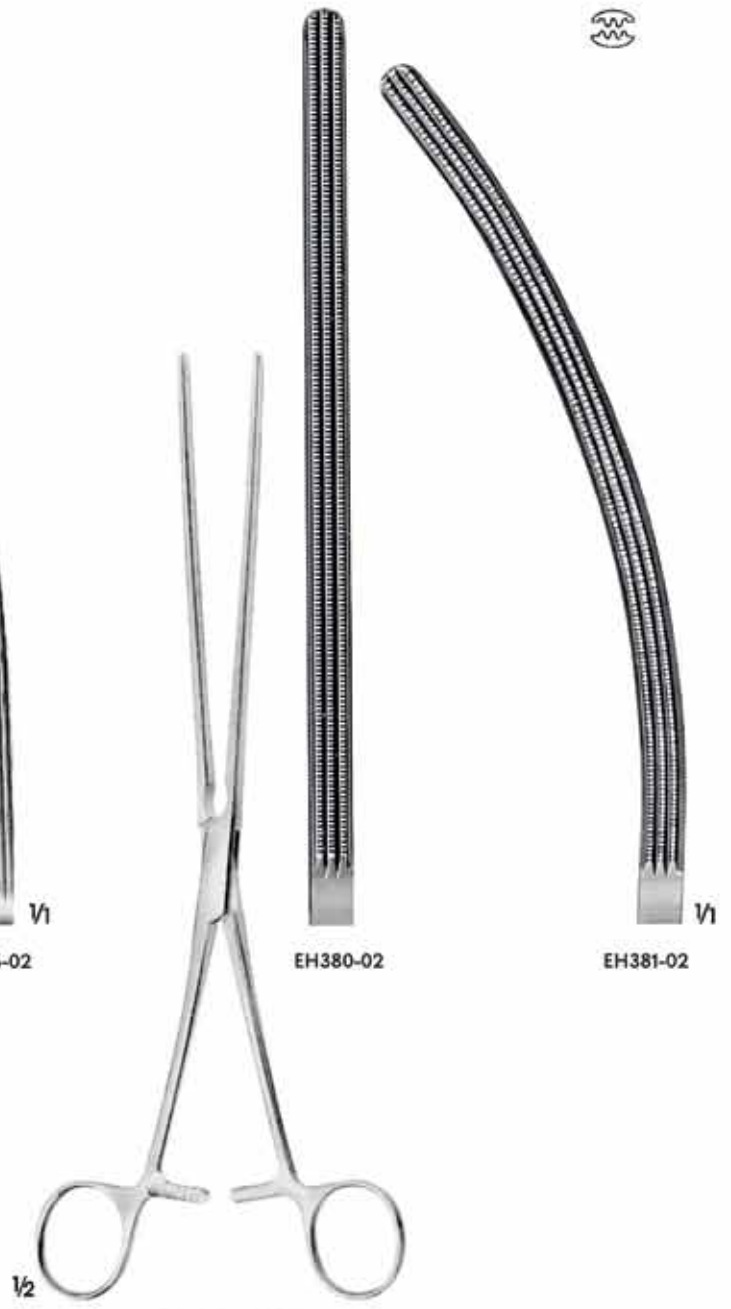

EH381-02

MAYO-ROBSON
EG375-02-EG376-02
Sert ve elastik
Hard and elastic
25 cm

MAYO-ROBSON
EH380-02-EH381-02
25 cm

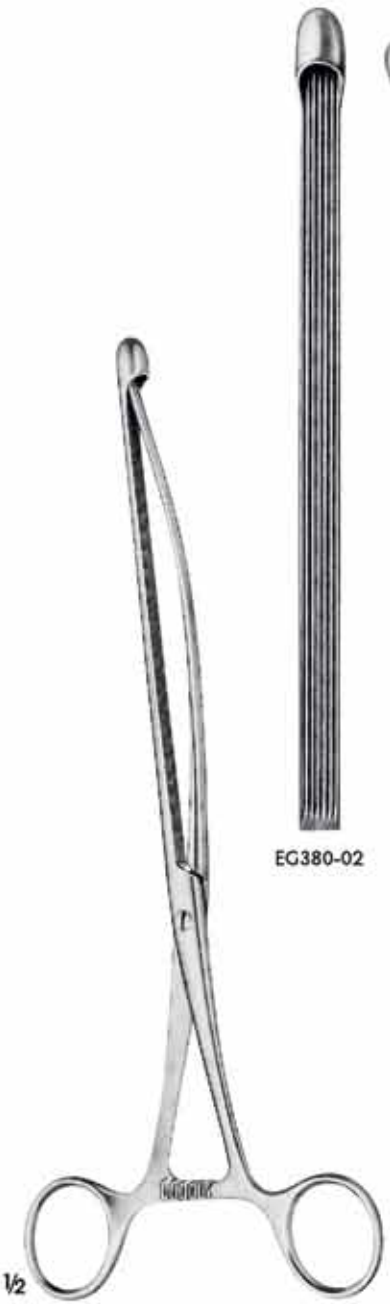
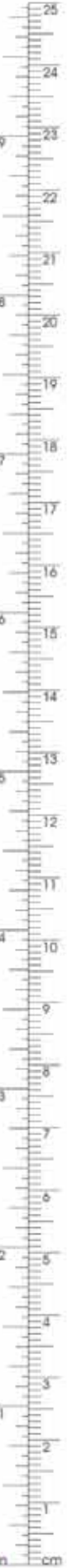

EG380-02

EG381-02

NUSSBAUM
EG380-02-EG381-02
Yumuşak ve elastik
Soft and elastic
25 cm

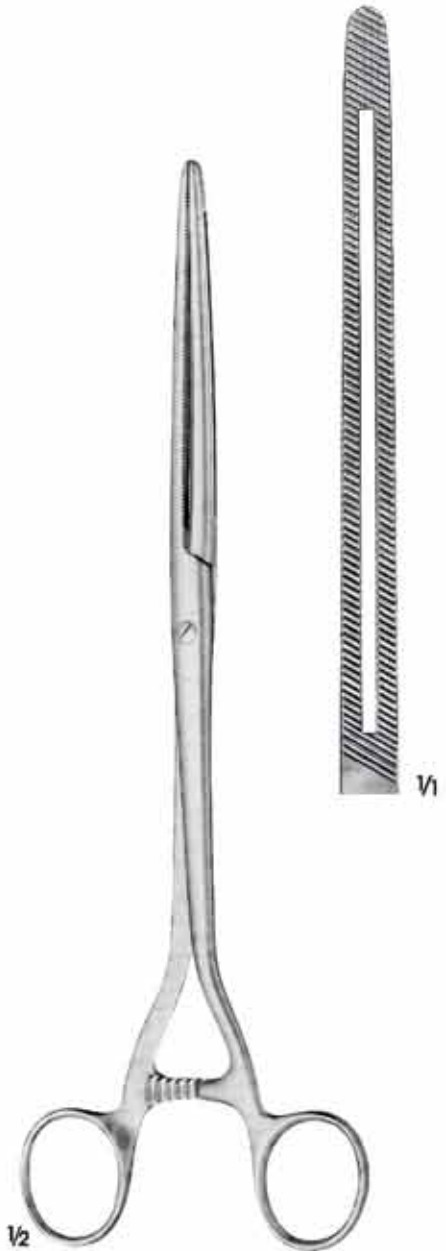

MAYNIHAN
EG385-02
28 cm

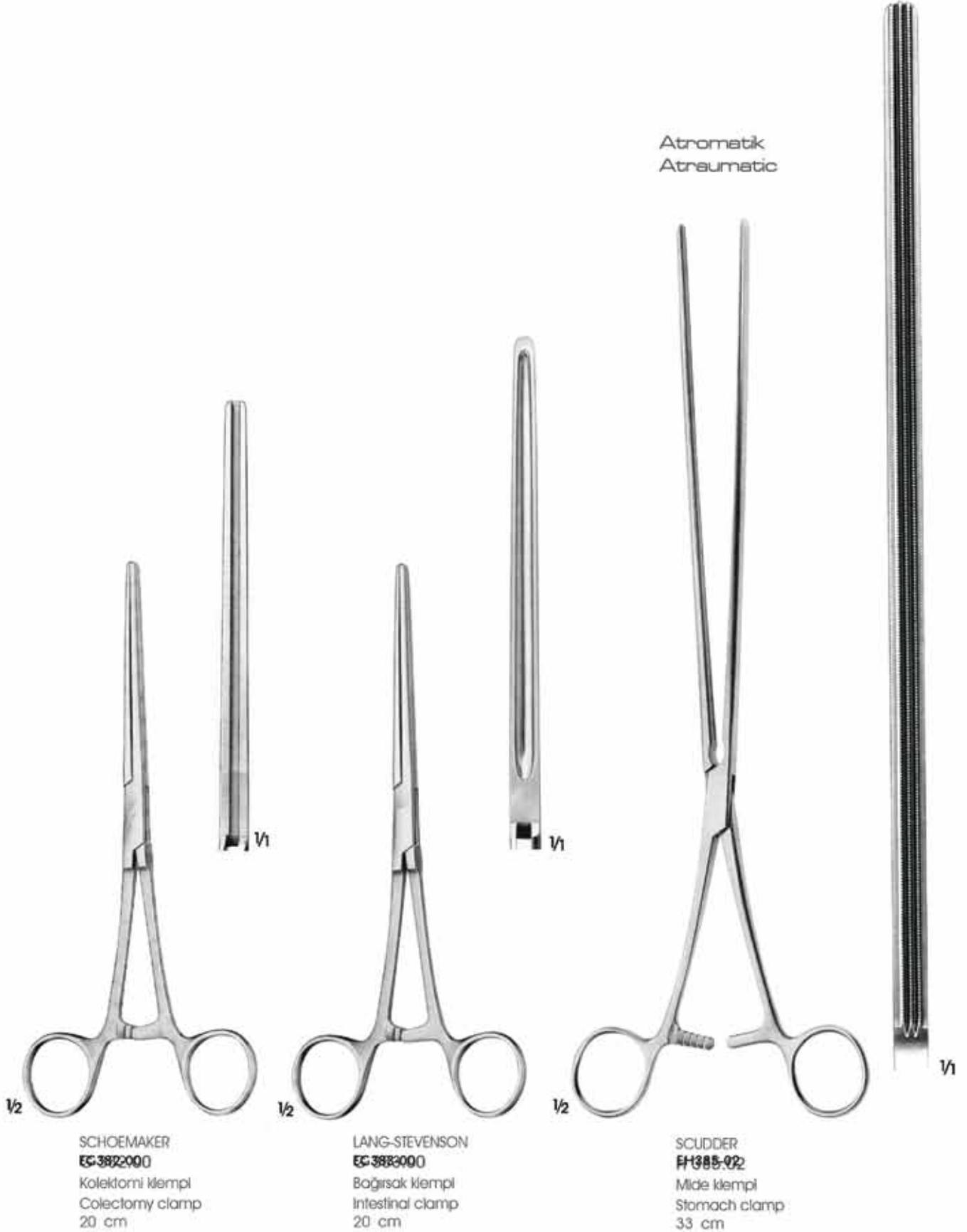



PAYR
EG580-00
Çocuklar için bağırsak klempi
Intestinal clamp light pattern,
for children
18 cm

PAYR
EG580-02
20 cm

PAYR
EG580-04
27.5 cm

PAYR
EG580-06
Pilor Klempi
Pylorus clamp
31.5 cm



LANE
EG480-02
31 cm

LANE
EG482-02
31 cm



1/2

HABERER
EG484-02
36 cm



1/1





BENSON
EG398-00
Pilor ayırıcı
Pylorus spreader
15,5 cm



KLEINSCHMIDT
EG350-00
Apendektomi klempli
Appendectomy clamp
13 cm



DE MARTEL-WOLFSON
EG585-00 10 cm
EG585-01 12 cm
Anastomoz klempli, 3'lü set
Anastomosis clamps,
set of 3



Sert Klempli tutucu
Clamp holder with set of clamps

EG587-23 22,5 cm
Klempli tutucusu
Clamp holder
[G 585.00-G 585.01]

EG587-08 8 cm
Klempli tutucusu
Clamp holder
[G 585.00-G 585.01]



DE MARTEL-WOLFSON
EG589-00
Kapama pensisi G 585.00-G 585.01 için
Closing forceps for G 585.00-G 585.01
25 cm

Atromatik
Atraumatic



DICK
EH200-00 25.5 cm
EH200-01 26.5 cm
EH200-02 27.5 cm
Güçlü klempler
Pressure clamps



EH200-00
78 mm



EH200-01
88 mm



EH200-02
98 mm

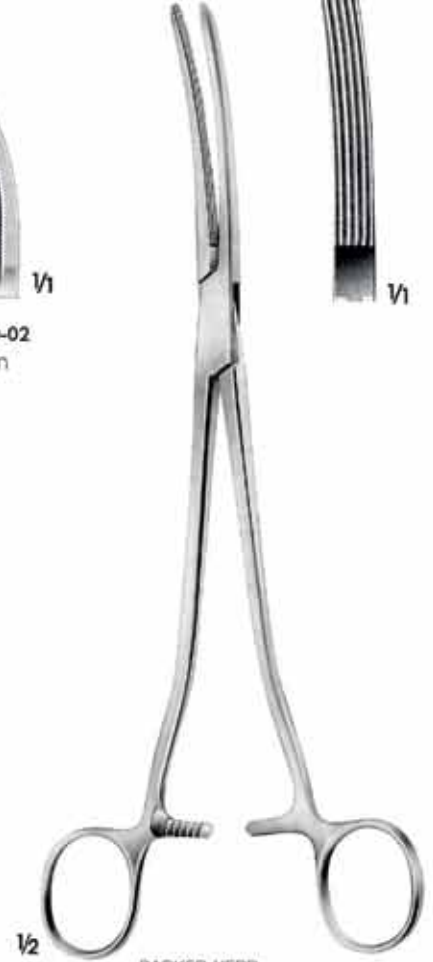

PARKER-KERR
EG463-02
Anastomoz pensı, kolon
rezeksiyonu için
Anastomosis forceps for
colon resection
25 cm



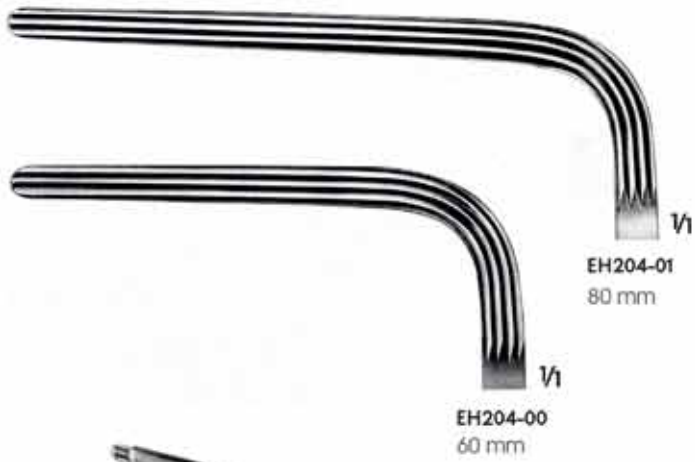



LLOYD-DAVIS
EG490-02
31.5 cm

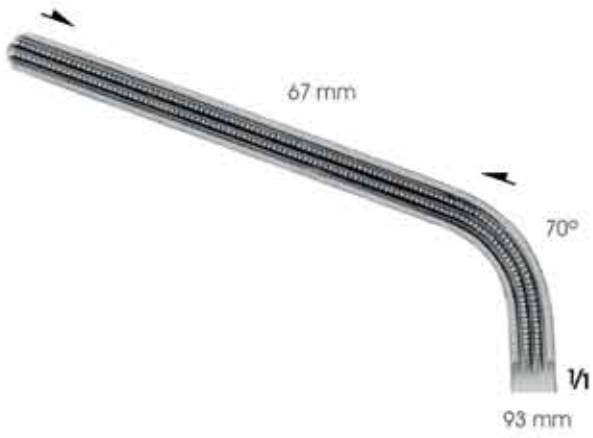

MORRIS
EH460-00
17.5 cm



DE BAKEY (MORRIS)
EH461-00
24 cm

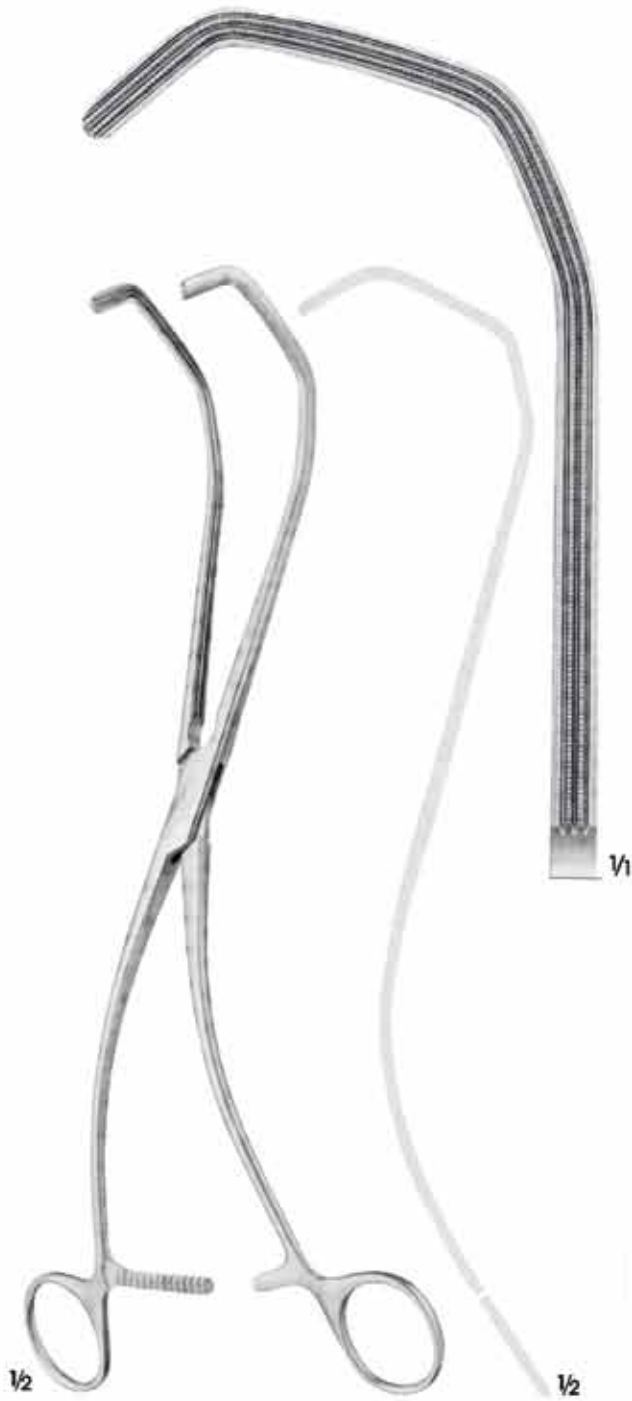

KERSTING
EH375-03
30 cm



RESONE
EH377-03
Yumuşak/Elastic
26.5 cm

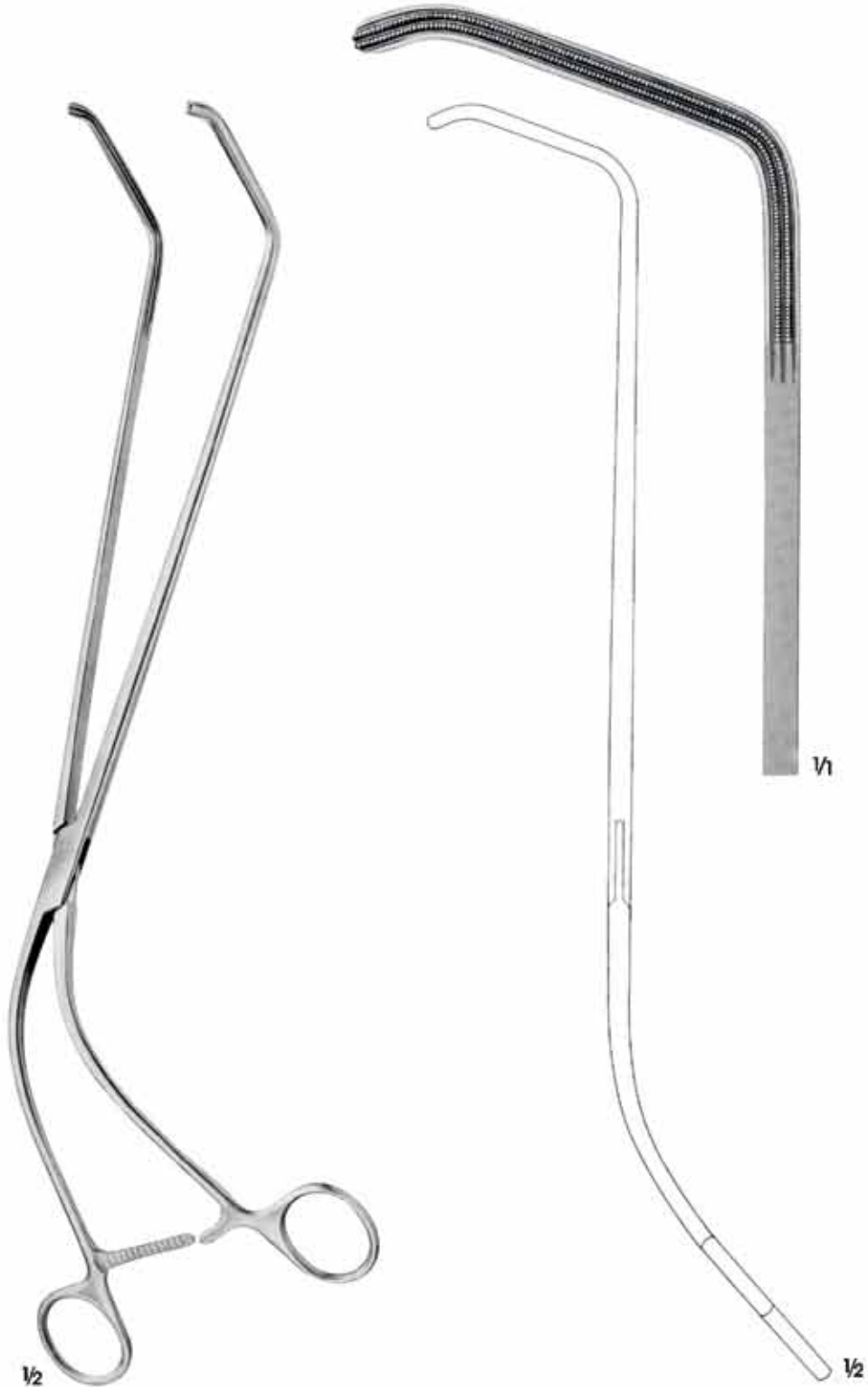

1/2

1/2

1/2

MULLER
EH378-00
Rektal anastomoz klomp
Rectal anastomosis clamp
37.5 cm

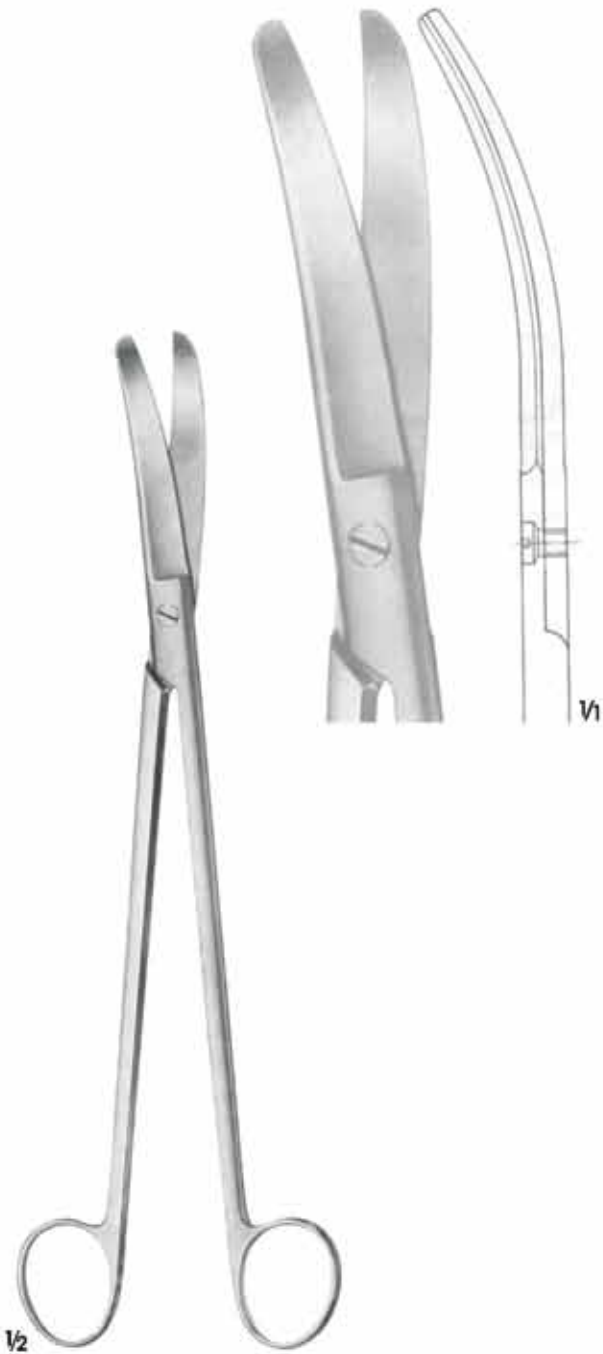

1/2

LLOYD-DAVIES (GOUGHER'S)
EC571-04
27 cm

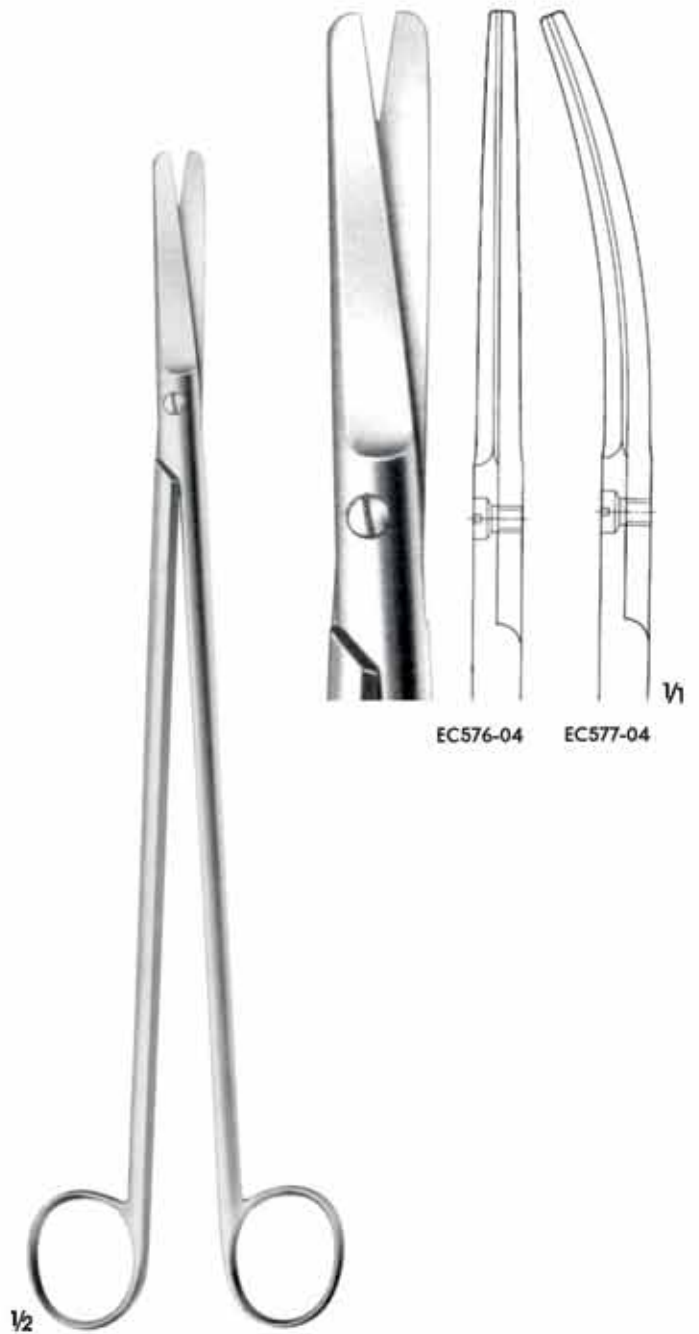

1/2

STELZNER
EC576-04-EC577-04
31 cm



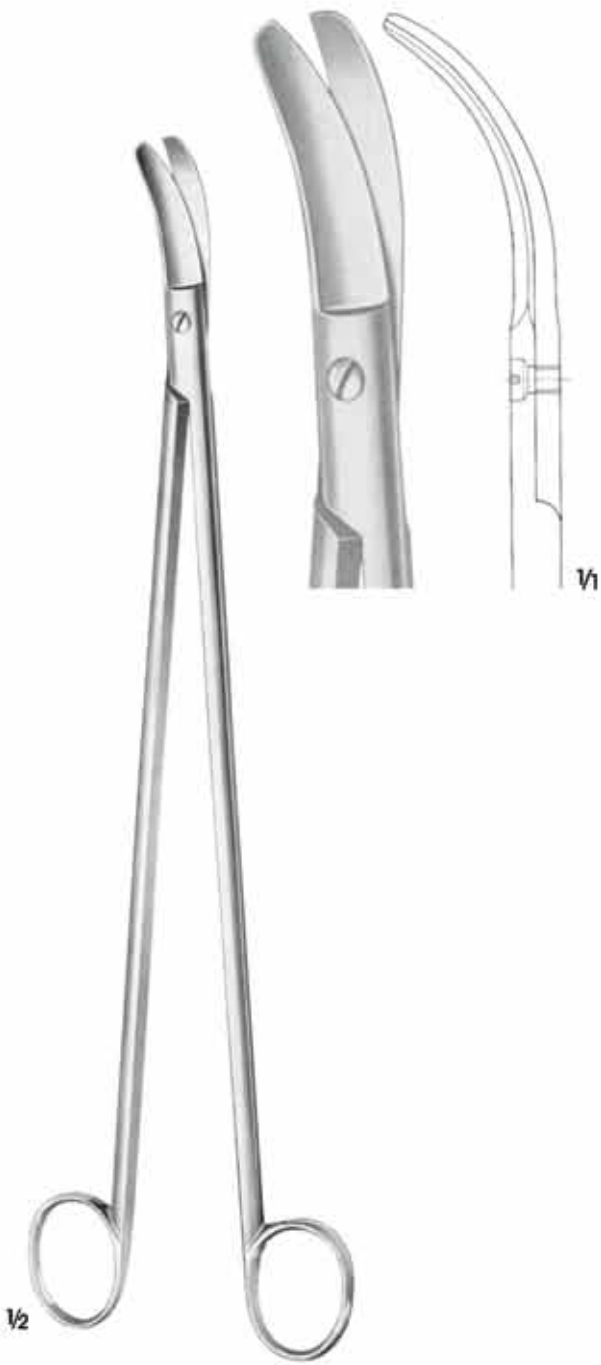

EC579-04
Rektal makas
Rectal scissors
32.5 cm

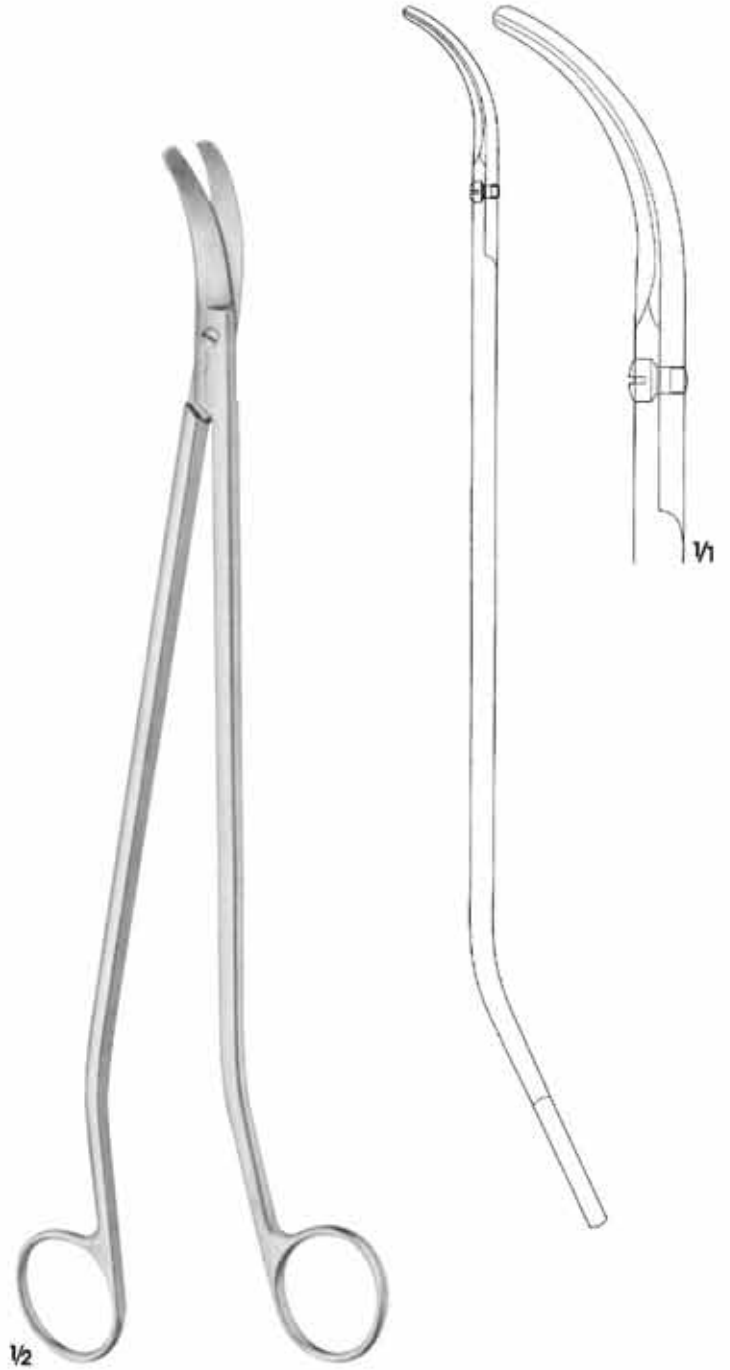

MÜLLER
EC578-00
Rektum makas s şekli
Rectum scissors s-shaped
32.5 cm



ALLIS
EE150-10
Tutma pensil
Grasping forceps
29.5 cm

Atromatik
Atraumatic



DE BAKEY
ED266-03
35 cm

HARDTIPS



MÜLLER
EF354-00
Portegü/Needle holder
36 cm



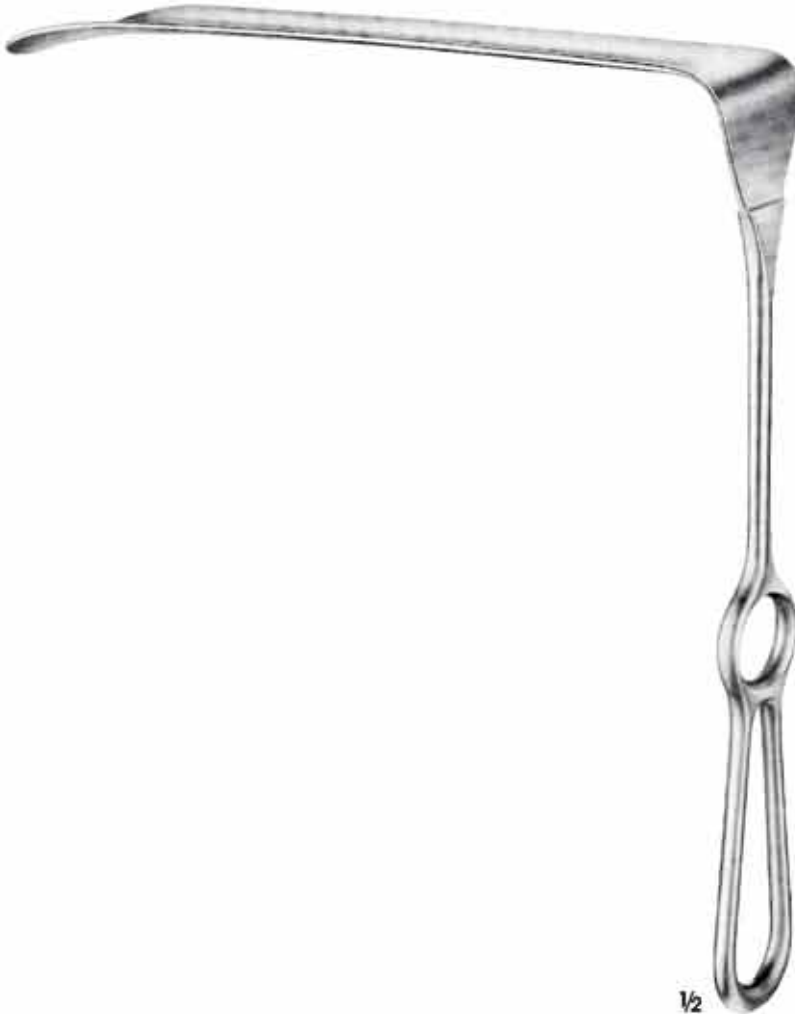
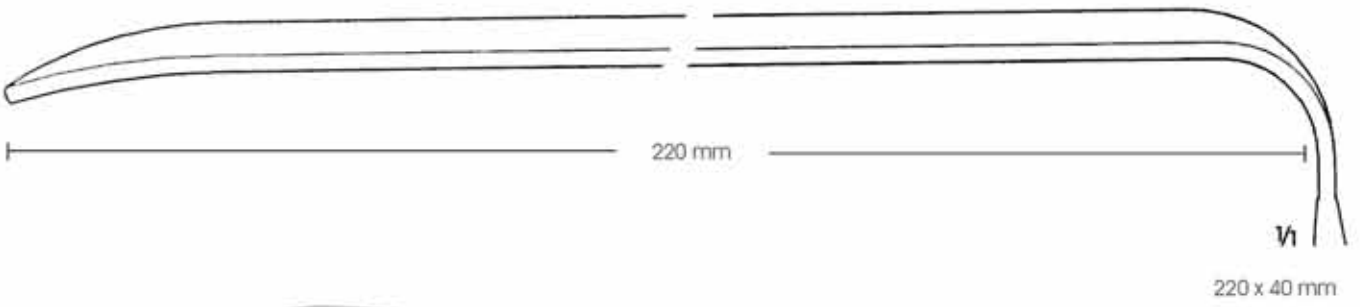

HÖSEL
EK609-06
Ekartör /Retractor
25 cm

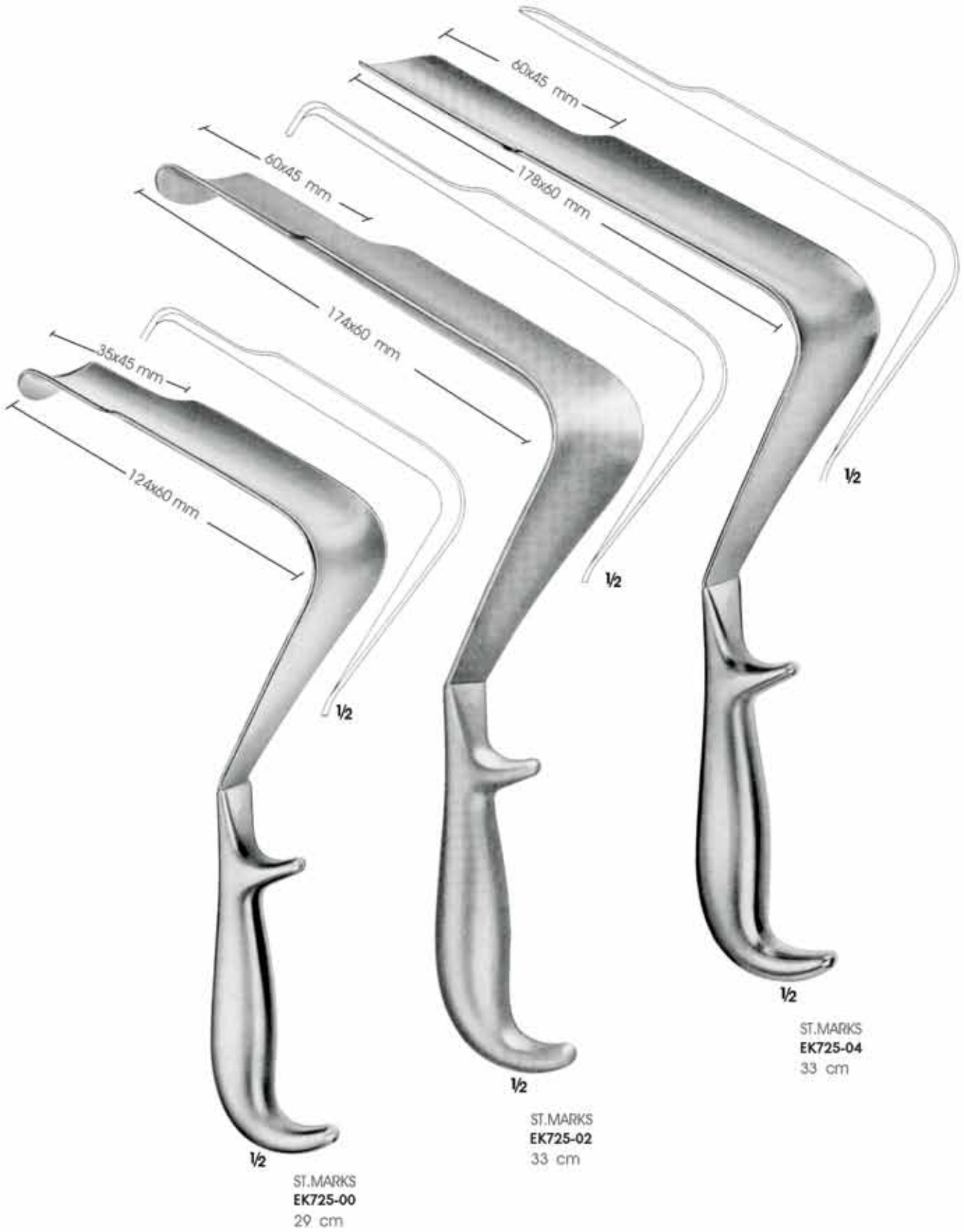

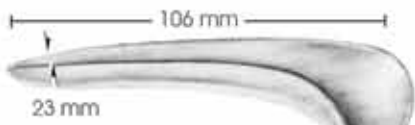

1/2

**CZERNY
EL700-00**
22.5 cm

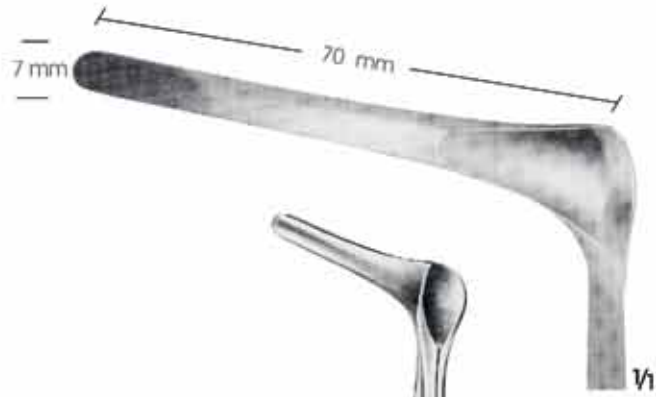

1/1

1/2

**KILLIAN
EL650-00**
Çocuk için/For children
14.5 cm



**SIMS
EL705-00**
Çocuk için/For children
19 cm

1/2



EL705-04
23.5 cm

1/2



**SIMS
EL705-02**
Yetişkinler için/For adults
23.5 cm

1/2

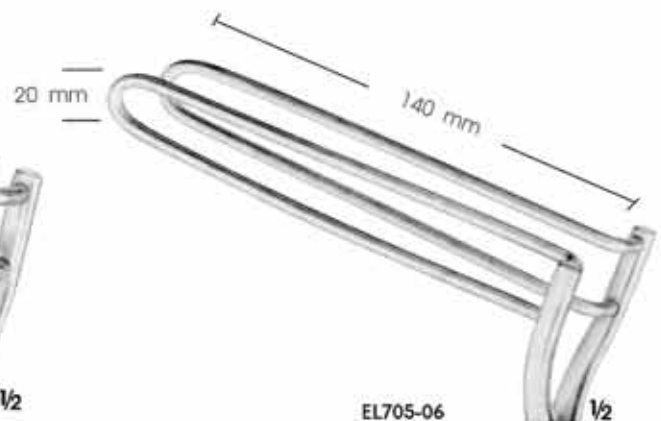

EL705-06
24.5 cm

1/2



1/2

SIMS
EL707-00
16 cm



1/2

SIMS
EL708-00
16 cm



1/2

PRATT
EL710-00
20.5 cm

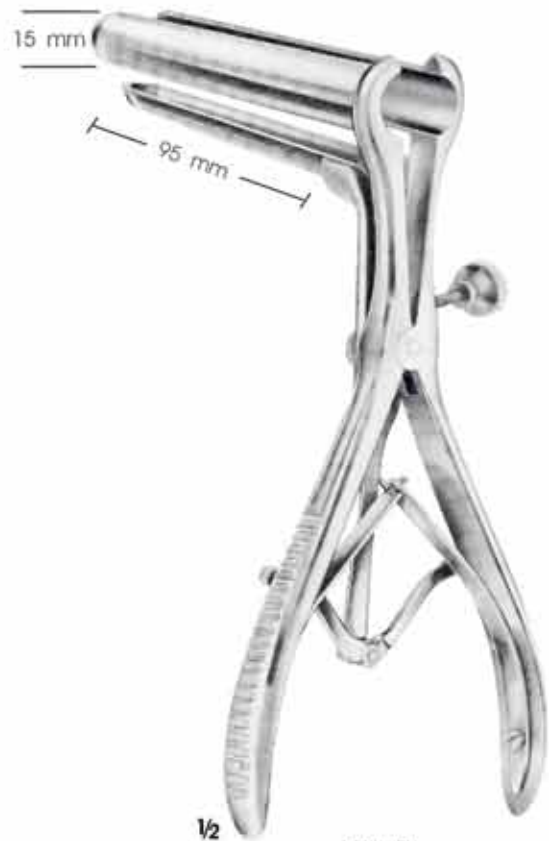

1/2

MATHIEU
EL712-00
21.5 cm





1/2
SIMS
EL714-00
15 cm



100 x 10 mm

1/2
COCK
EL716-00
19 cm



HIRSCHMANN
EL720-00 Ø 16 x 65 mm
EL720-01 Ø 19 x 65 mm
EL720-02 Ø 22 x 65 mm



KELLY
EL721-00 Ø 22 x 50 mm
EL721-01 Ø 22 x 100 mm
EL721-02 Ø 22 x 140 mm



1/2

BENSAUDE
EL725-00 Ø 17 mm
EL720-01 Ø 20 mm
EL720-02 Ø 23 mm
 Anoskoplar/Anoscopes
 18.5 cm



1/2

IVES-FANSLER
EL728-00 Ø 24 mm
 Anoskop/Anoscope
 14.5 cm



1/2

KELLY
EL730-00 Ø 20 mm
 Anoskop/Anoscope
 16 cm

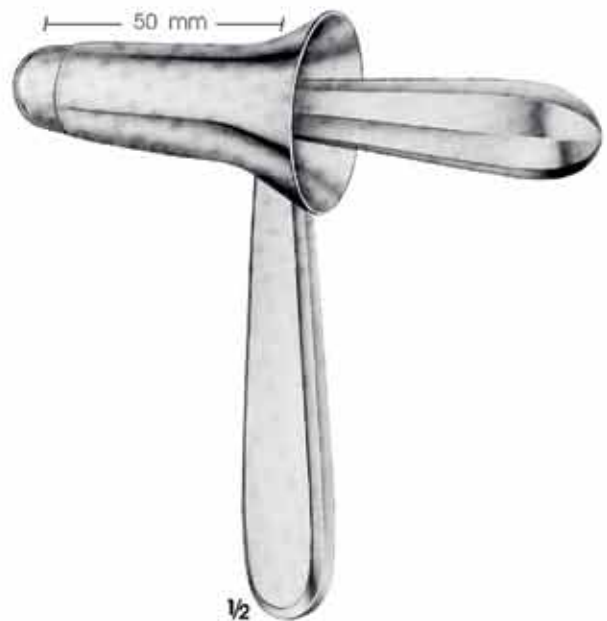

1/2

KELLY
EL730-01 Ø 25 mm
 Sfinteroskop/Sphincteroscope
 16 cm

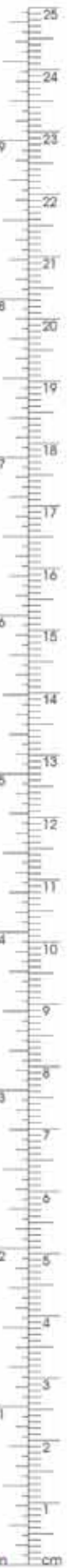

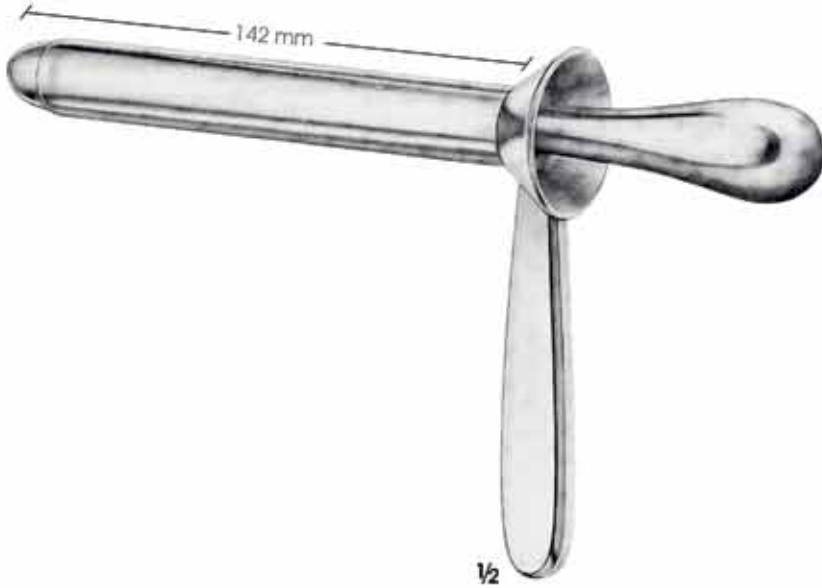

1/2
KELY
EL732-00
Proktoskop
Protoscope
14 cm



1/16
EL738-10
ACM İngiliz standardı fiber ışık taşıyıcı
Fibre light attachment,
ACM/British standard
for NAUNTON-MORGAN specula



NAUNTON-MORGAN
EL738-00 Komple/Complete
EL738-06 1 adet Ø 17 mm spekulum
16.5 cm
1 each Ø 17 mm specula 16.5 cm
EL738-10 1 adet fiber ışık taşıyıcı
1 each fiber light attachment

NAUNTON-MORGAN
EL738-01 Komple/Complete
EL738-07 1 adet Ø 21 mm spekulum
16.5 cm
1 each, Ø 21 mm specula 16.5 cm
EL738-10 1 adet fiber ışık taşıyıcı
1 each fiber light attachment

NAUNTON-MORGAN
EL738-02 Komple/Complete
EL738-08 1 adet Ø 24 mm spekulum
16.5 cm
1 each Ø 24 mm specula 16.5 cm
EL738-10 1 adet fiber ışık taşıyıcı
1 each fiber light attachment

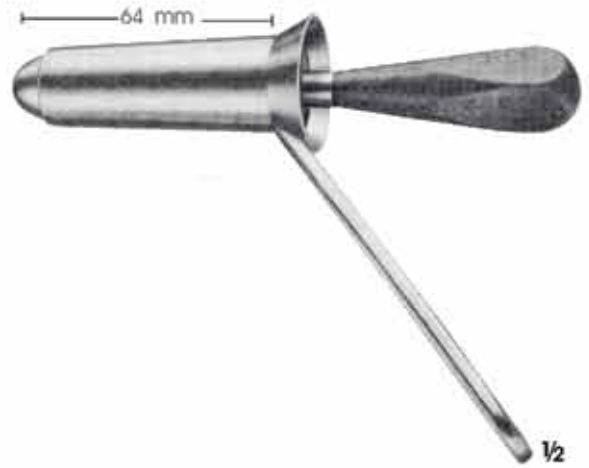

GABRIEL
EL736-00 Ø 25 mm
Rektal spekulum
Rectal speculum

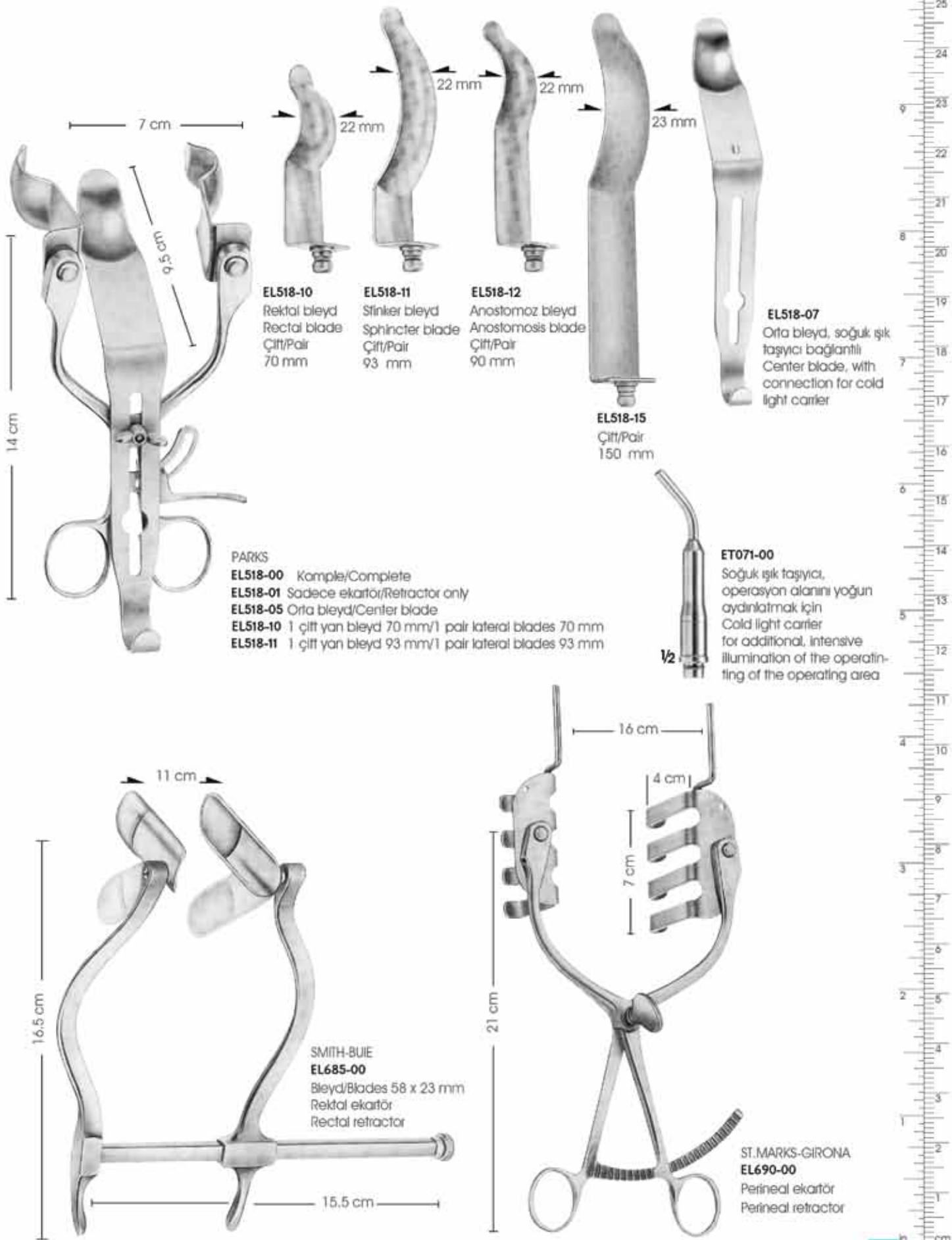

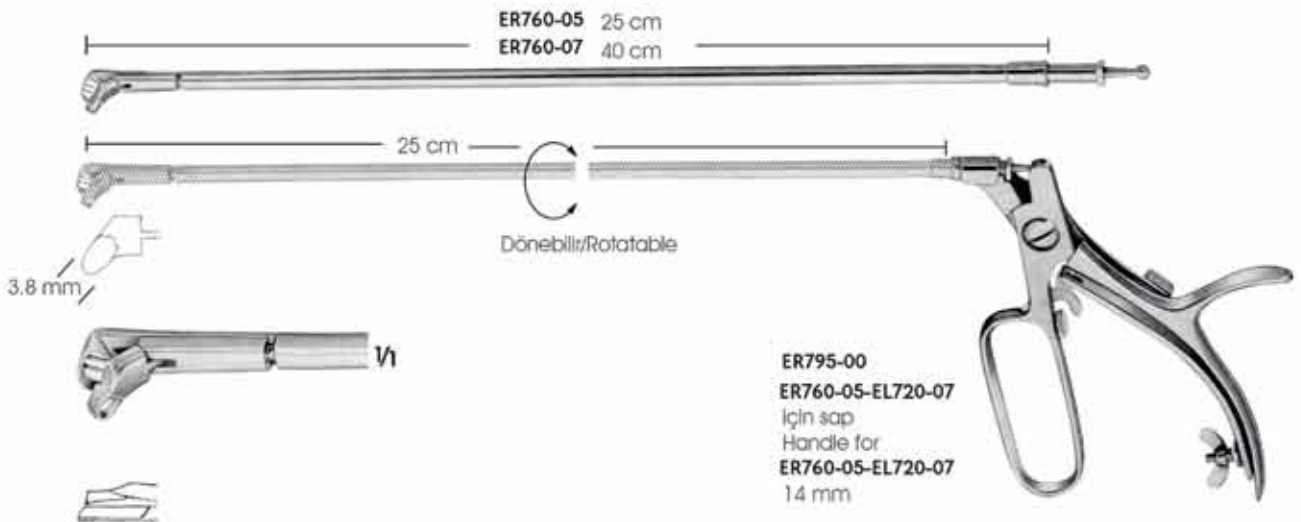
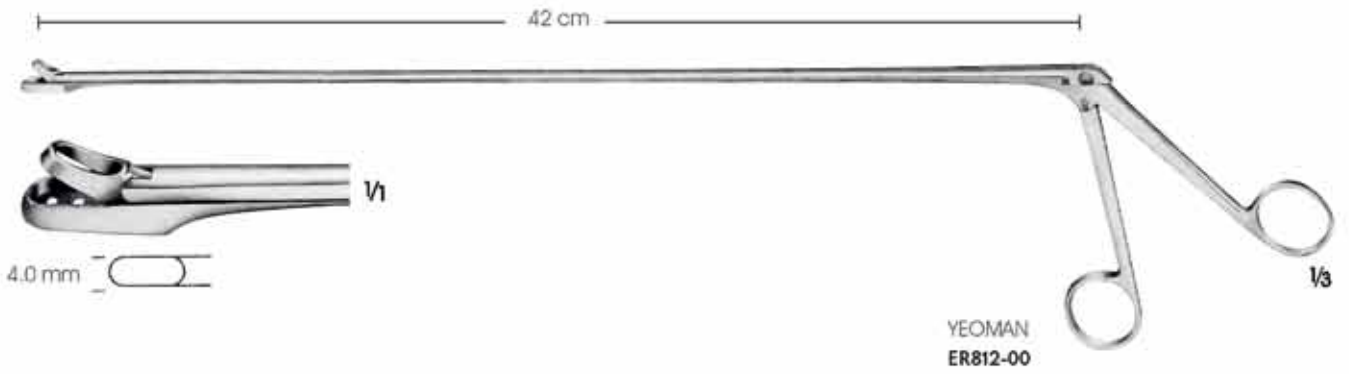
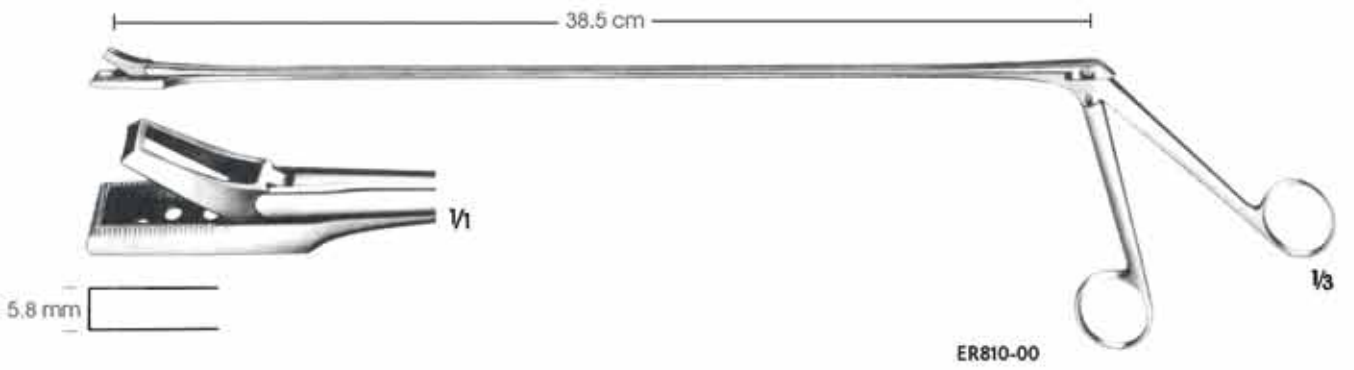
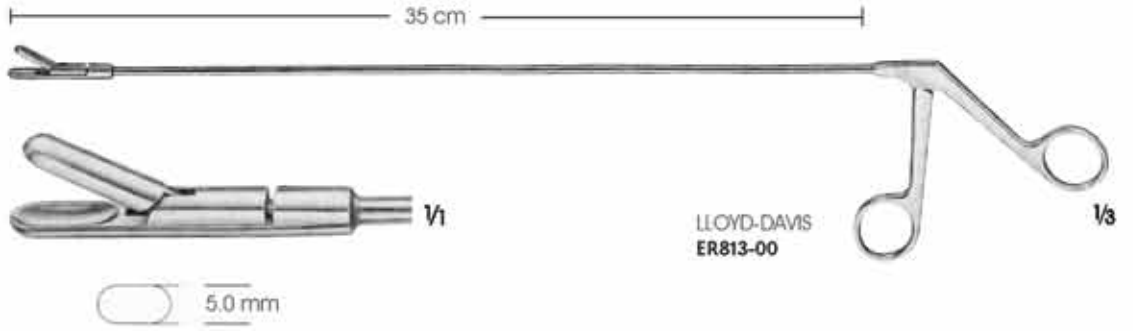

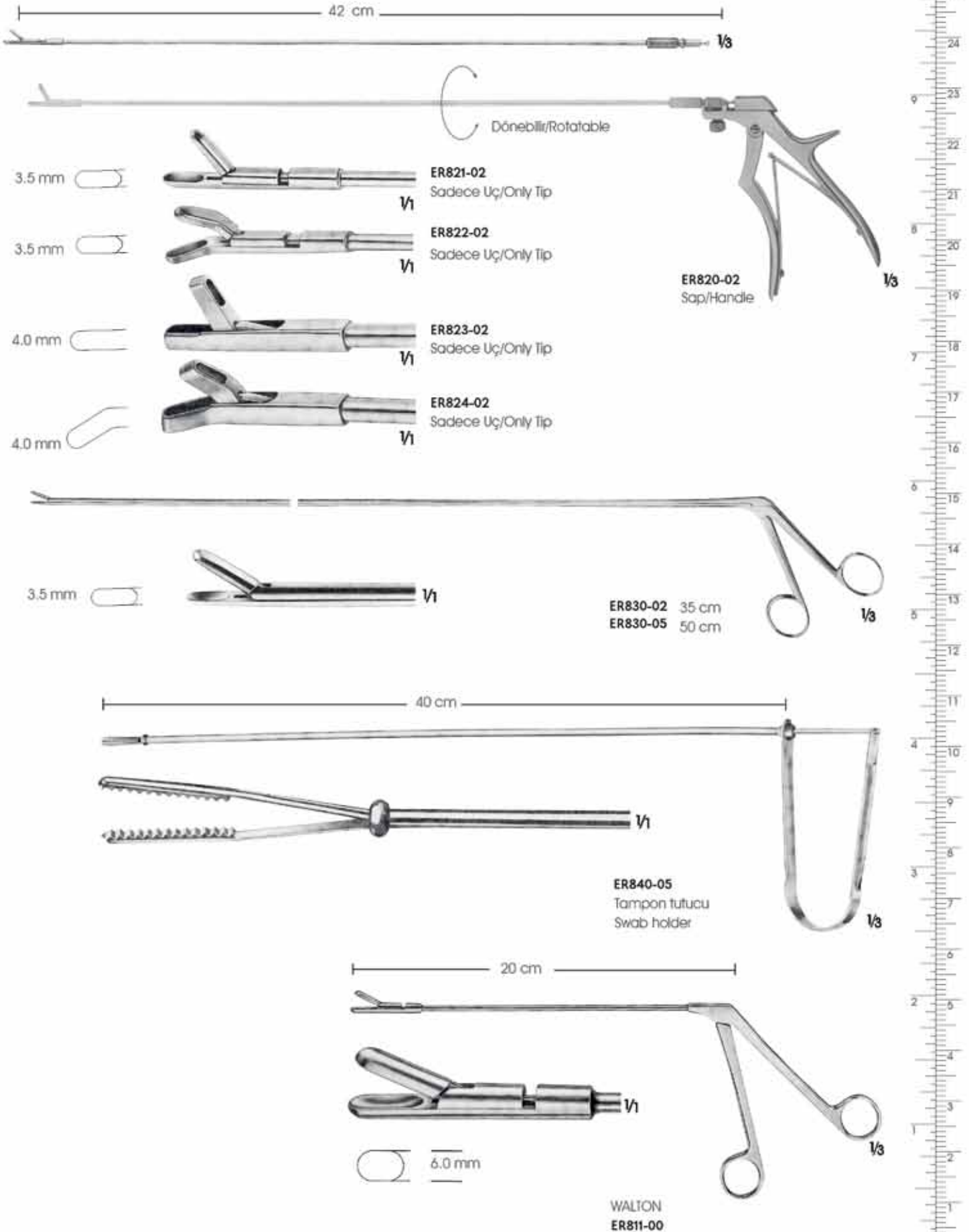

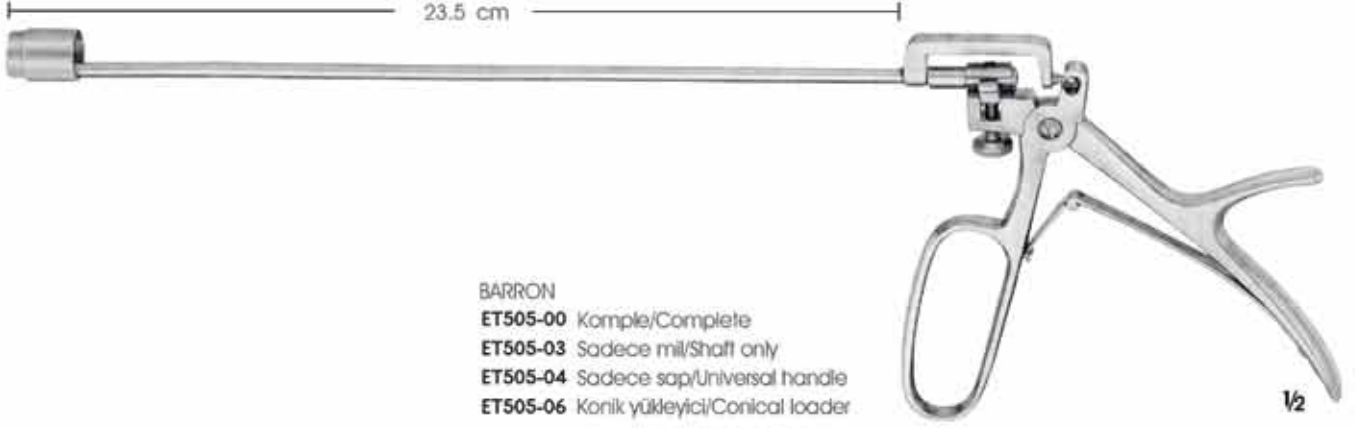

BARRON
ET505-00 Komple/Complete
ET505-03 Sadece mil/Shaft only
ET505-04 Sadece sap/Universal handle
ET505-06 Konik yükleyici/Conical loader

1/2



MC GIVNEY
EG570-00
Hemoroid pens
Hemorrhoidal forceps
18.5 cm

1/2



RUDD
ET500-01
Yükleme ekli 100 adet lastik halkası ile Hemoroid ligatörü
Hemorrhoidal ligator with loading attachment and 100 ligature rubber rings
31.5 cm

1/1



1/1

ET509-00
100 Adet/Paket
100 Pcs/Pack

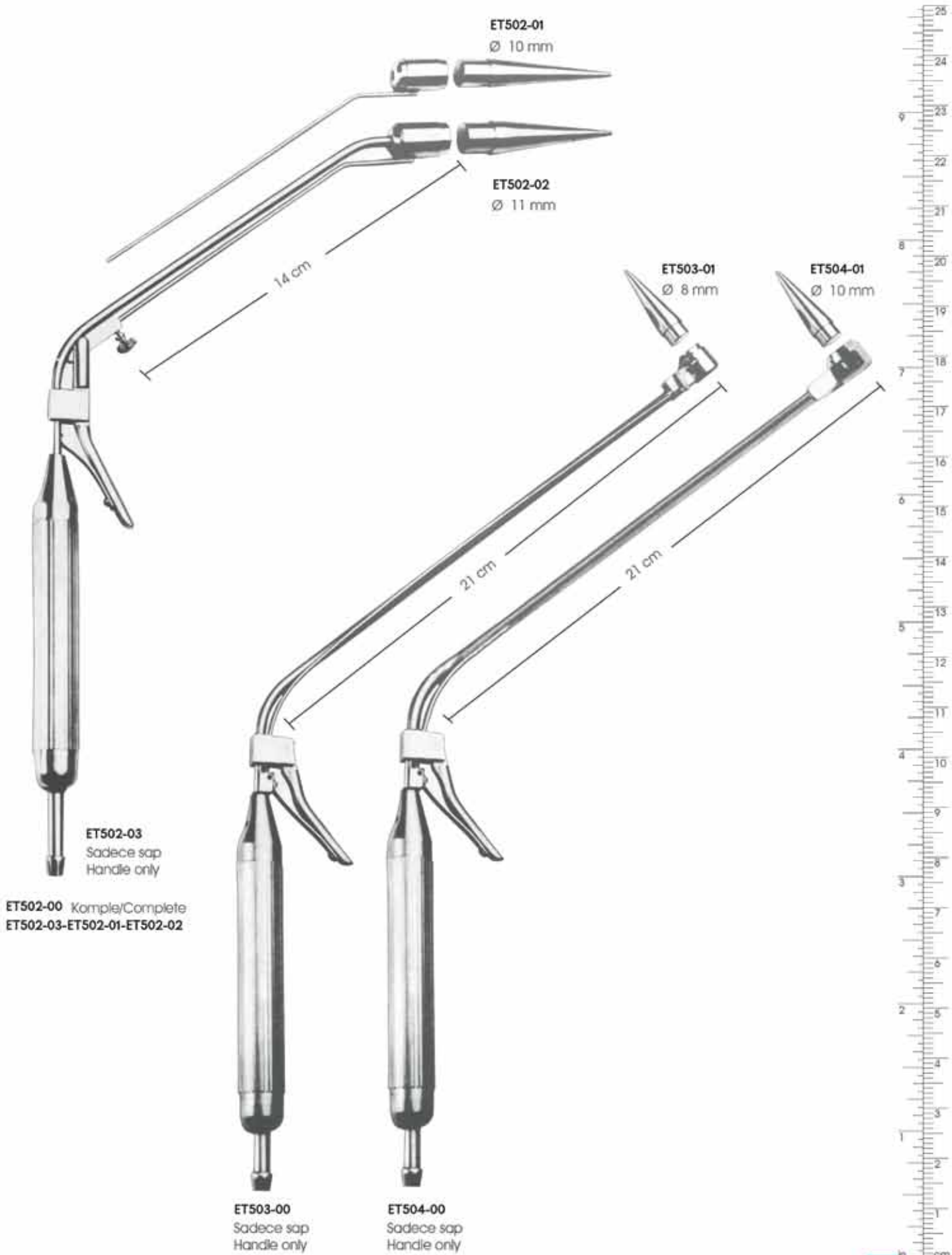

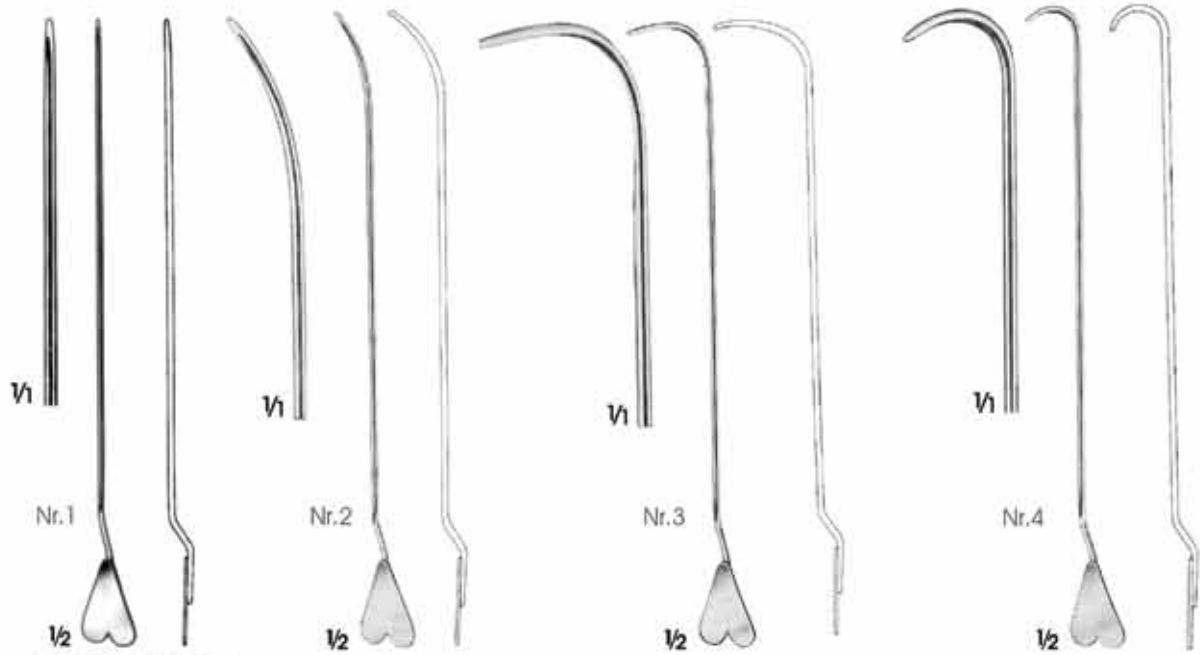

LOCKHART-MUMMERY

Fistül sonda/Fistula probes

EJ020-00 Nr.1 Düz/Straight

EJ020-01 Nr.2 45° Eğri/Curved

EJ020-02 Nr.3 90° Eğri/Curved

EJ020-03 Nr.4 Geriye doğru eğri/Curved retrograde
16.5 cm

Ø 3.5 mm



BIRODIE
EJ018-00
20 cm



EJ024-00
Bükülebilir/Malleable
19 cm

Ø 3 mm



EJ037-00
Çift delikli ve uçlu
bükülebilir sonda
Double ended probe,
malleable, with hole
19 cm



EK227-00
Fistül sonda
Fistula probe
24 cm

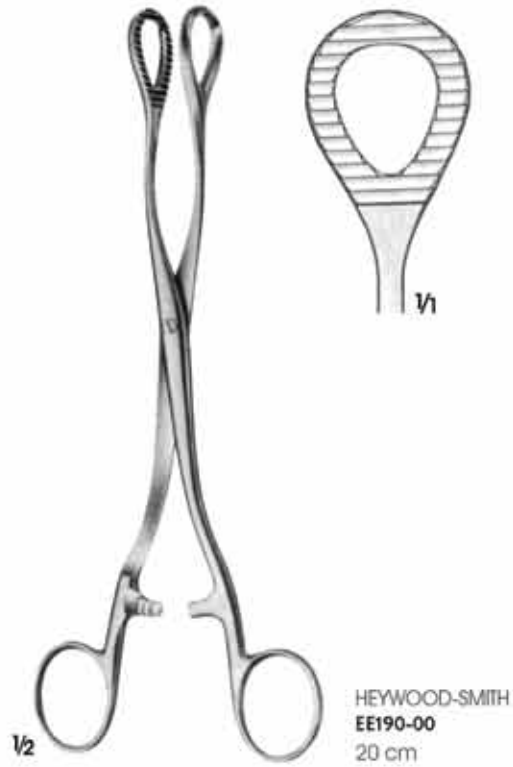
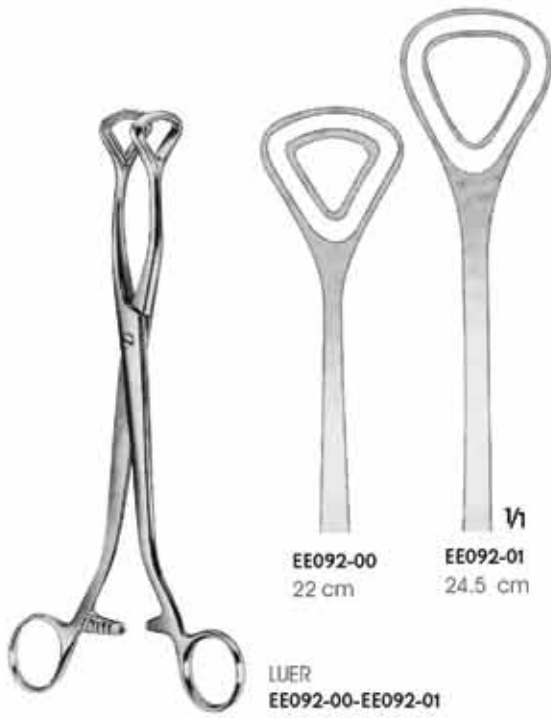

Atromatik
Atraumatic

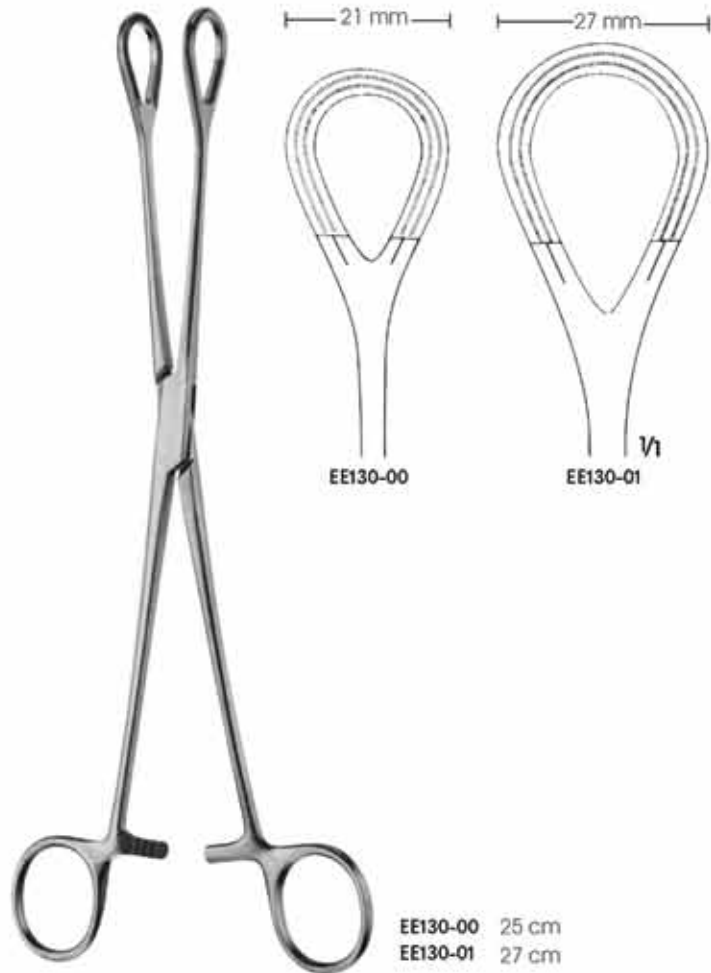
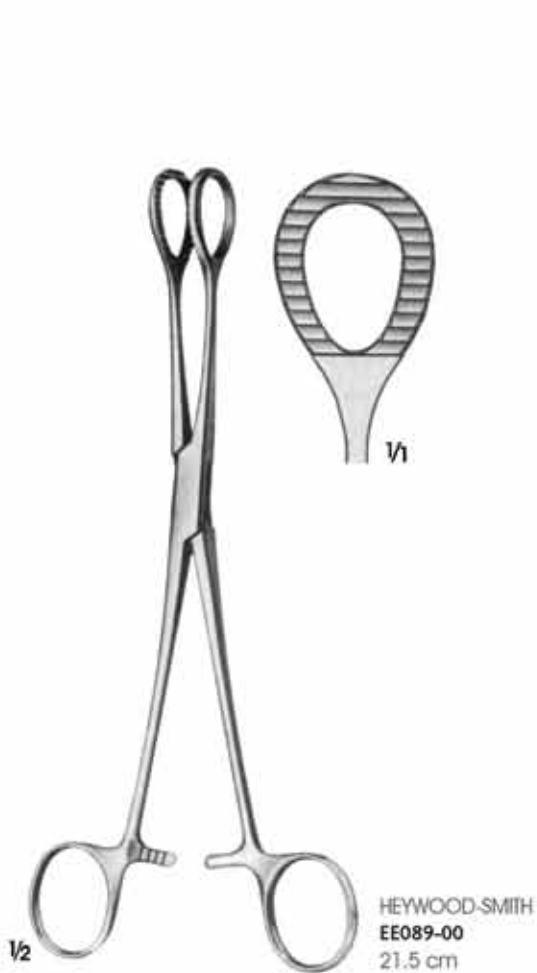

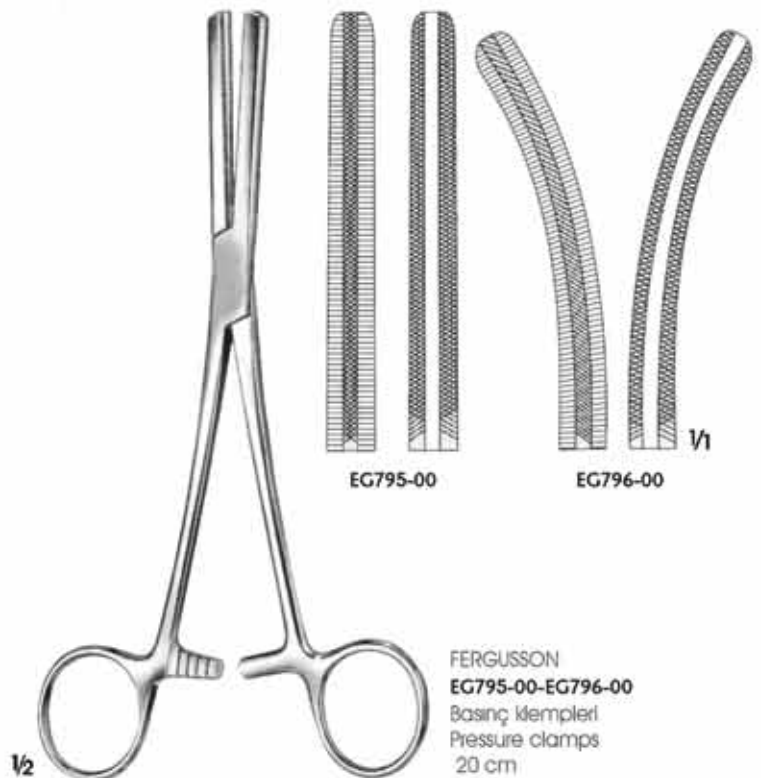
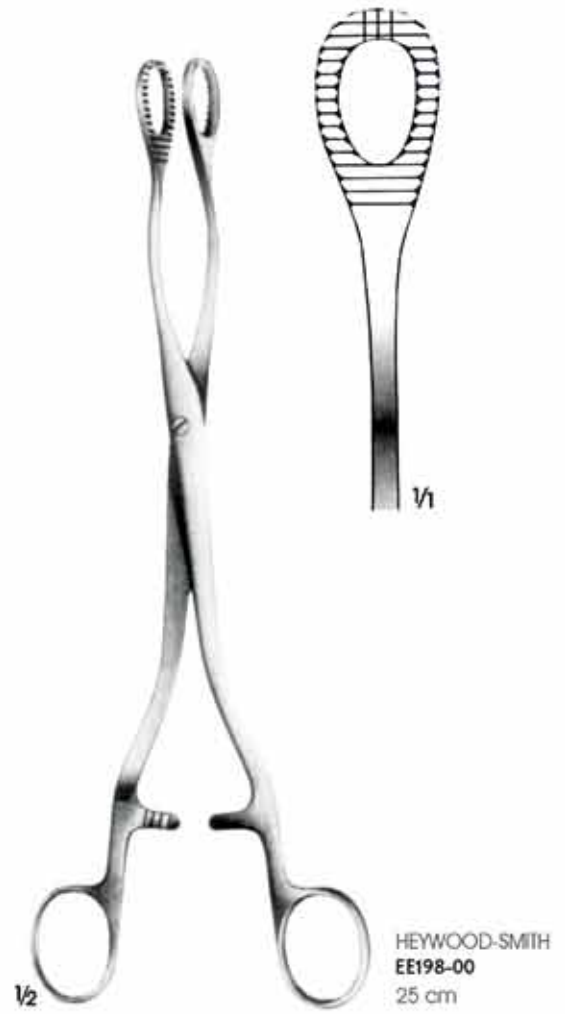
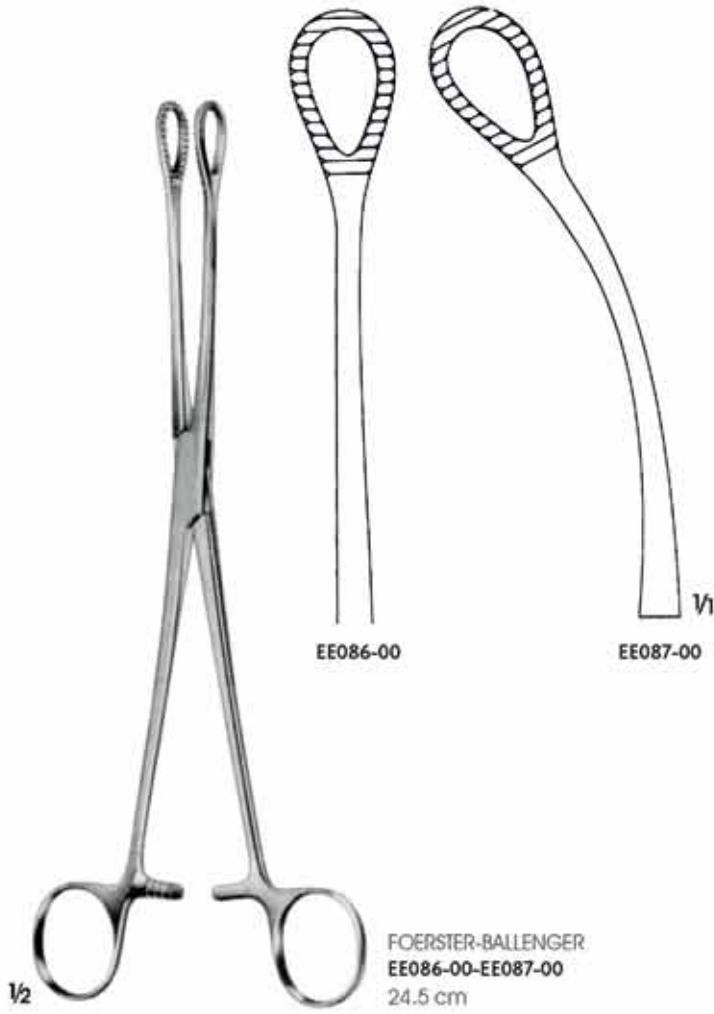

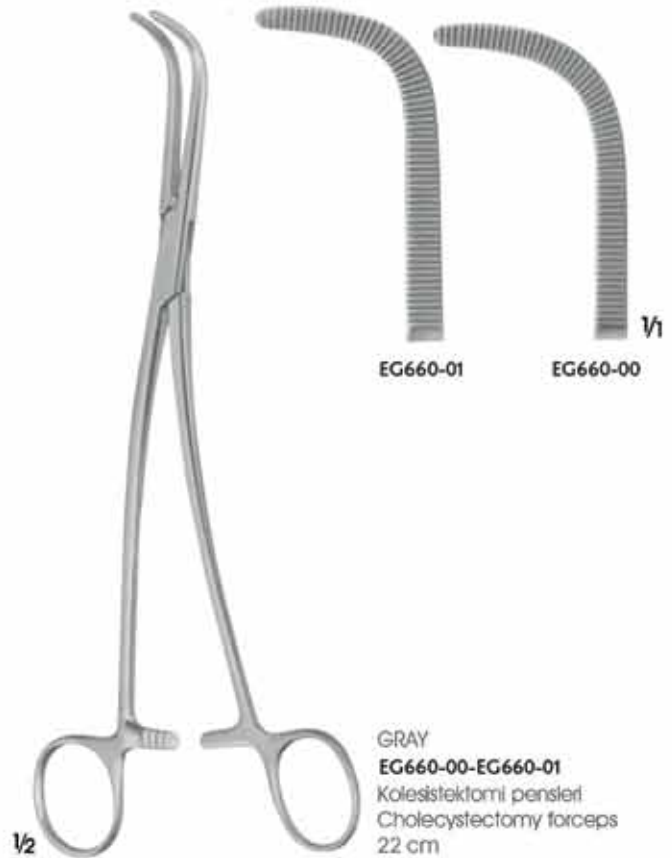



LOWER
EG670-00
18 cm



LAHEY(SWEET)
EG672-00
20 cm



LAHEY
EG672-01
22.5 cm



DESJARDINS
EG678-00
Ur kanalı ve kistlik pens
Gall duct and cystic forceps
22 cm

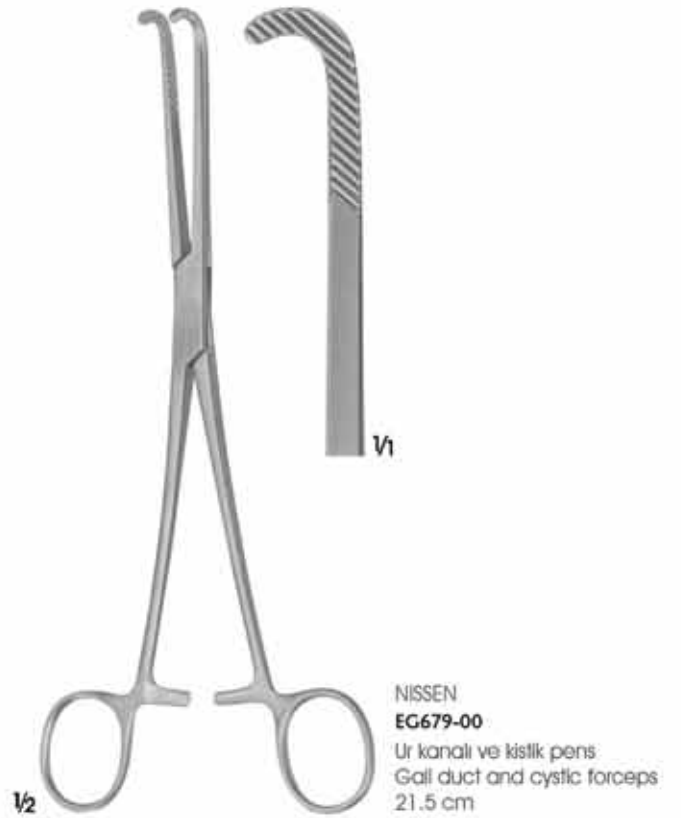

NISSEN
EG679-00
Ur kanalı ve kistlik pens
Gall duct and cystic forceps
21.5 cm

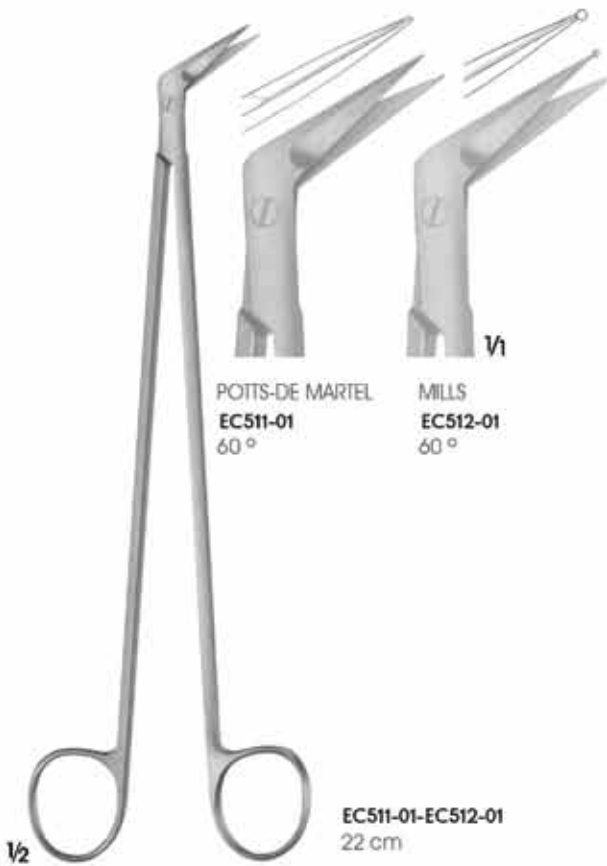
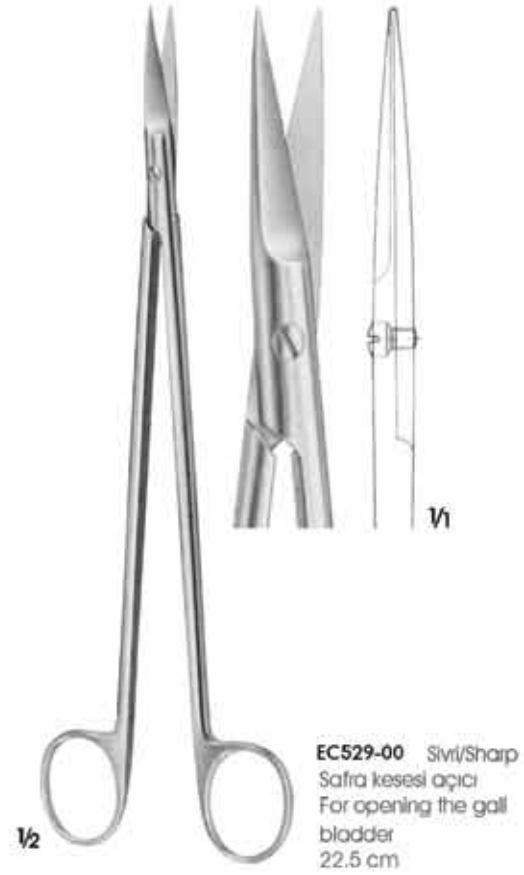

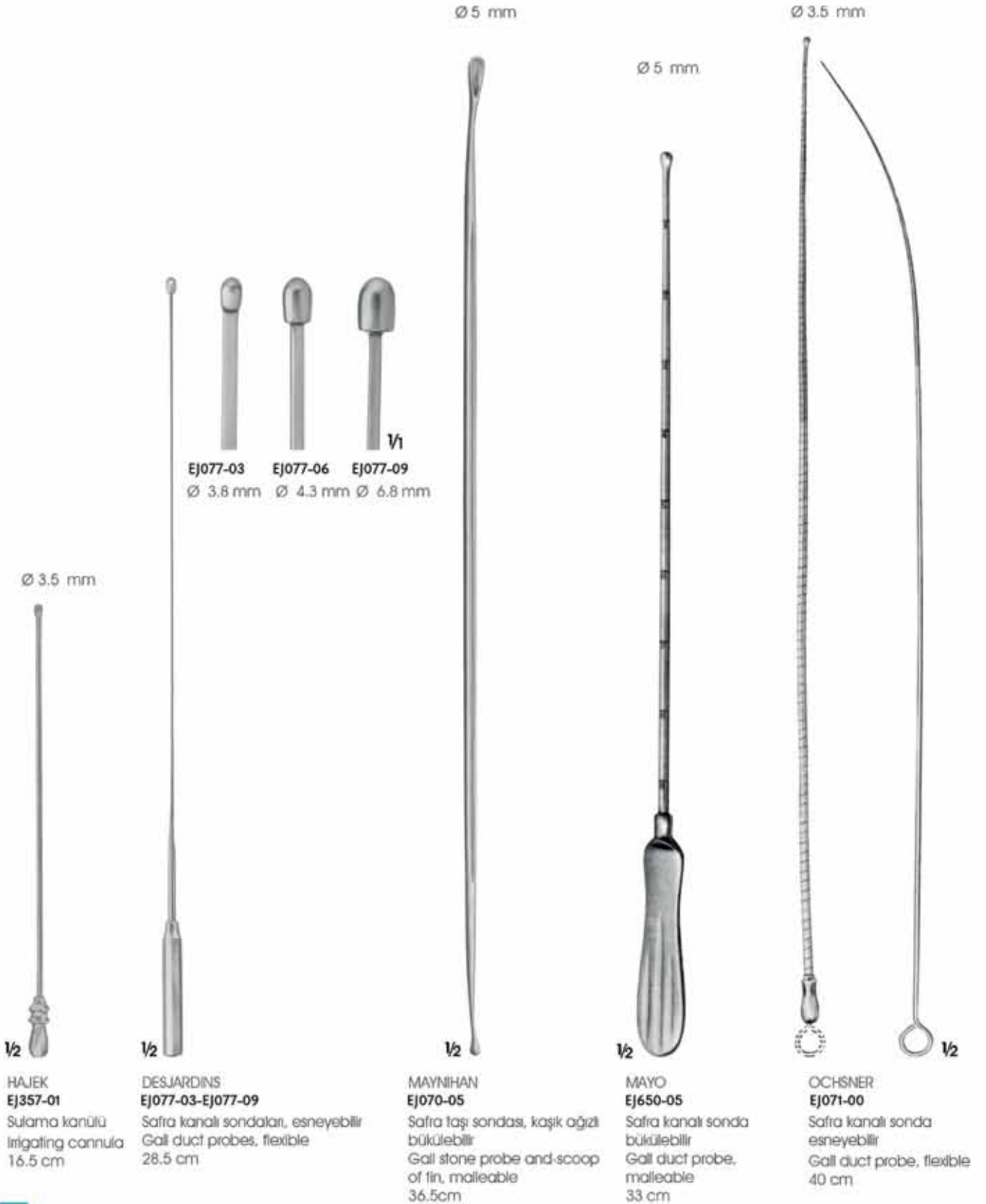



DESJARDINS
EN405-02-EN405-05
Esnek şaft sondalı ve yakalayıcı
Probe and catch with flexible shaft
30 cm



LUER-KÖRTE
EN410-02-EN410-09
Bükülebilir/Malleable
31 cm

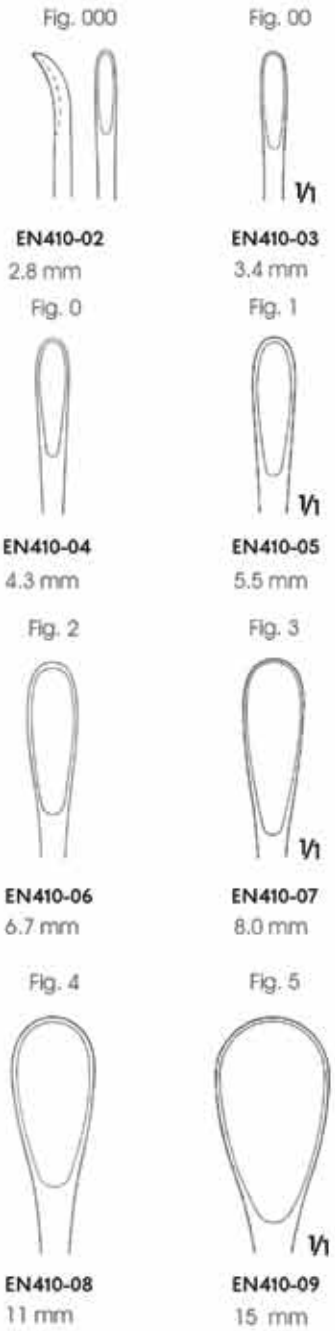

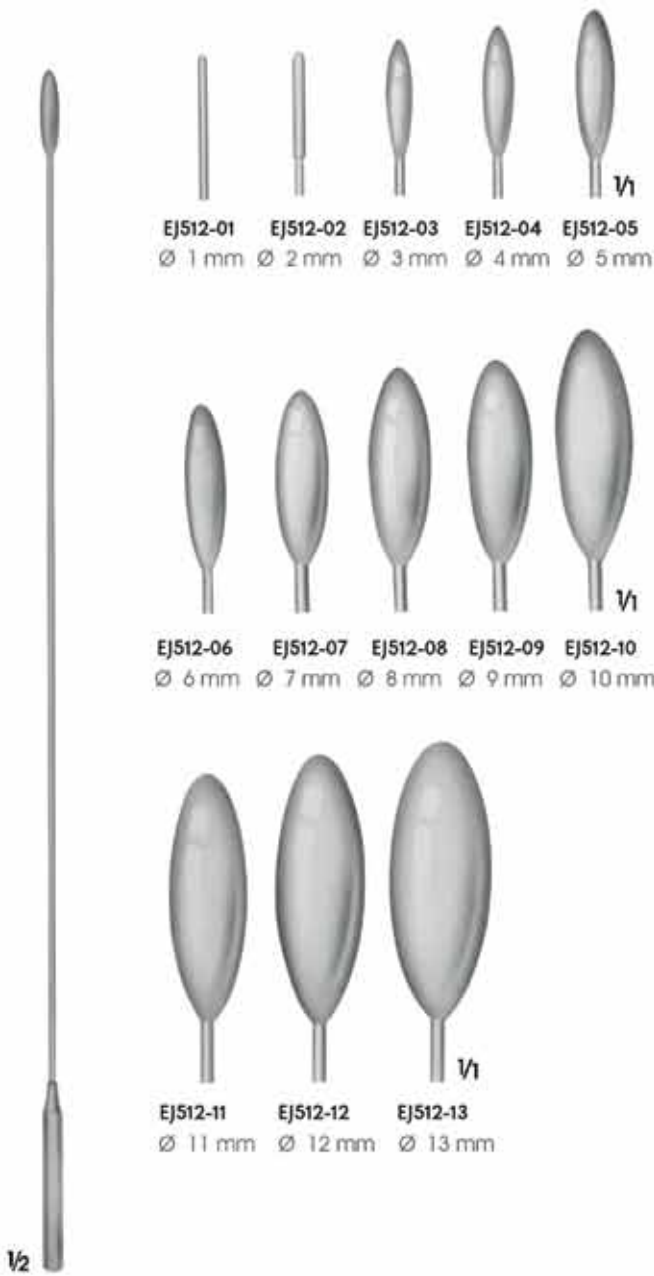

BAKES

EJ512-01-EJ512-013

Safra kanalı için bükülebilir dilatörler
Common bile duct dilators, malleable
31 cm



DITTEL

EJ080-08-EJ080-30

Metal buji ve dilatasyon sondaları
Metal bougies and dilating sounds
34.5 cm

Char.
(French)

EJ080-08	8
EJ080-09	9
EJ080-10	10
EJ080-11	11
EJ080-12	12
EJ080-13	13
EJ080-14	14
EJ080-15	15
EJ080-16	16
EJ080-17	17
EJ080-18	18
EJ080-19	19
EJ080-20	20
EJ080-21	21
EJ080-22	22
EJ080-23	23
EJ080-24	24
EJ080-25	25
EJ080-26	26
EJ080-27	27
EJ080-28	28
EJ080-29	29
EJ080-30	30

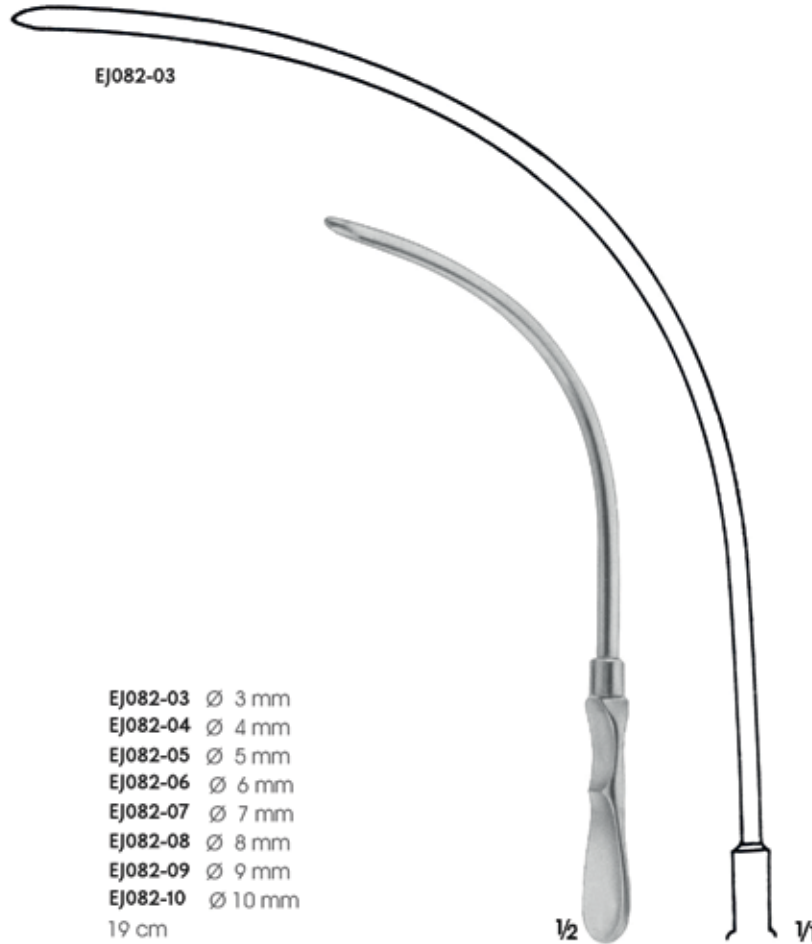
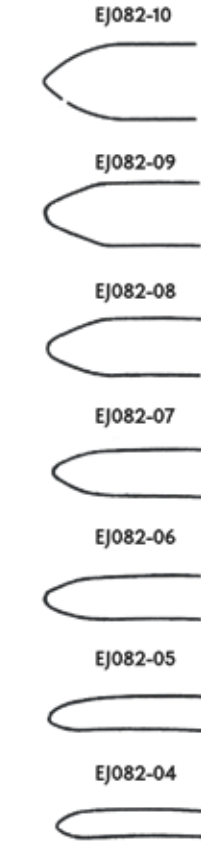

- EJ082-03 Ø 3 mm
 - EJ082-04 Ø 4 mm
 - EJ082-05 Ø 5 mm
 - EJ082-06 Ø 6 mm
 - EJ082-07 Ø 7 mm
 - EJ082-08 Ø 8 mm
 - EJ082-09 Ø 9 mm
 - EJ082-10 Ø 10 mm
- 19 cm



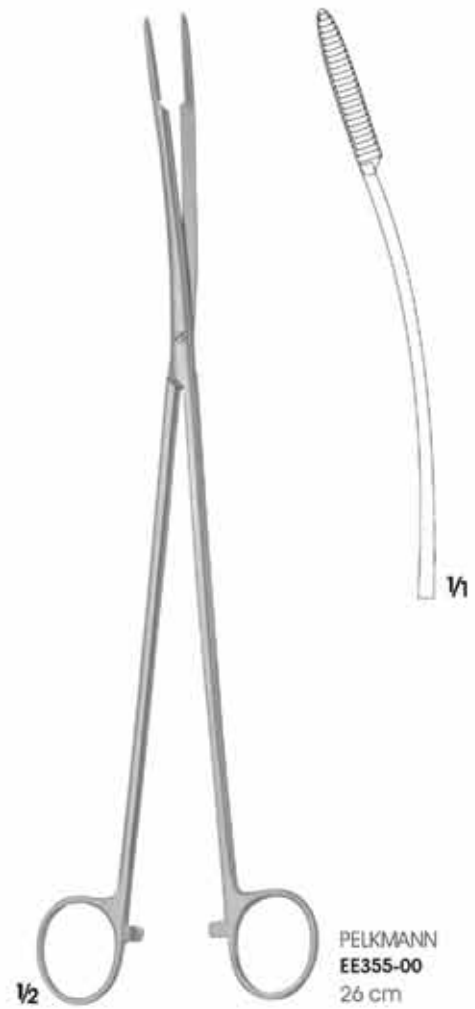
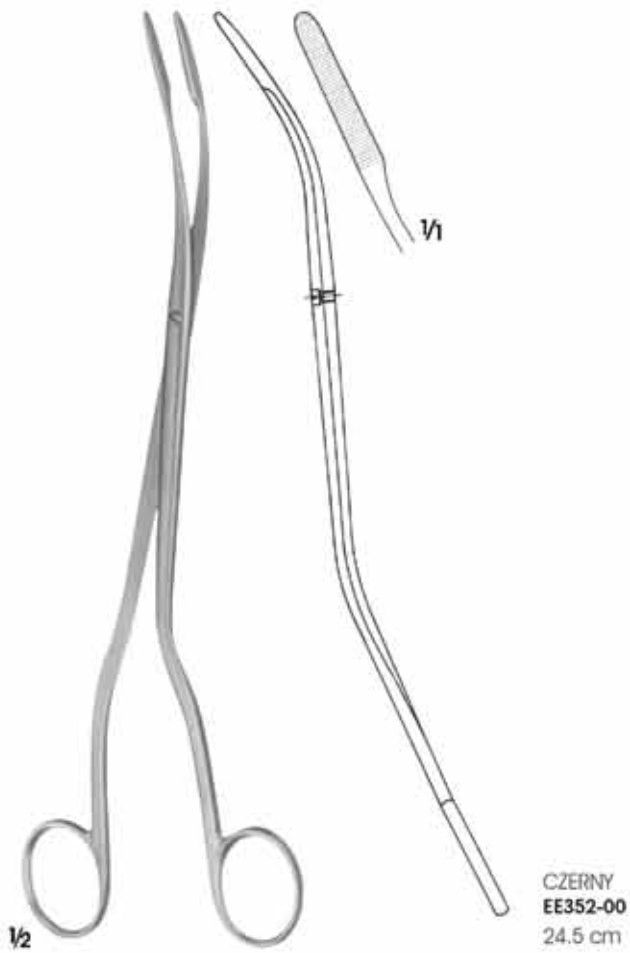
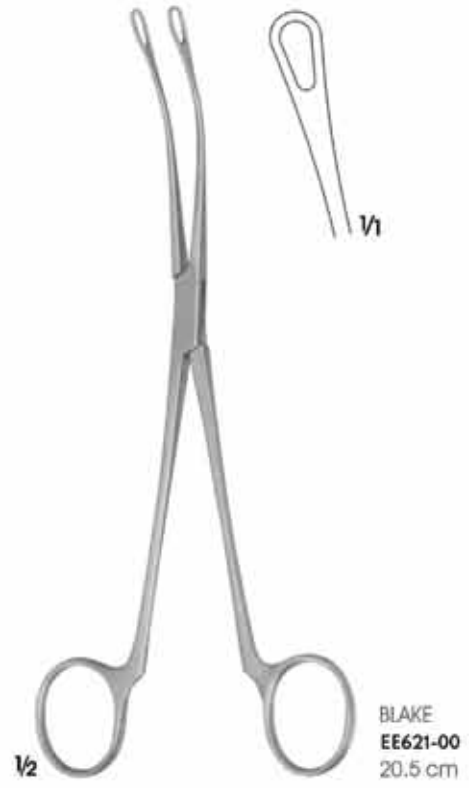
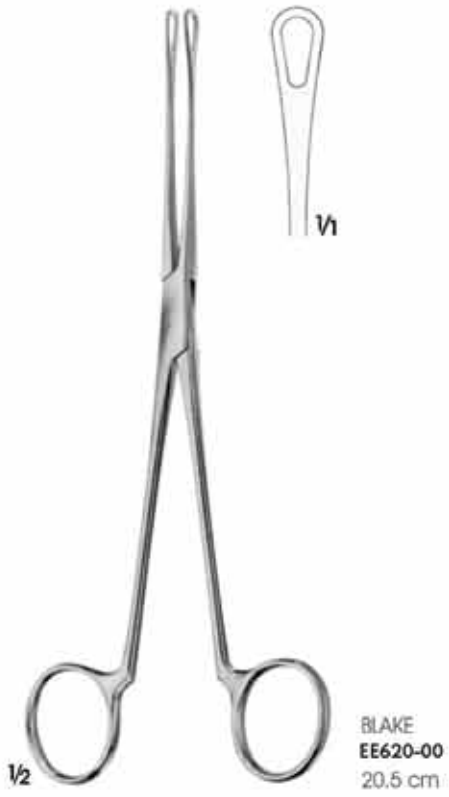

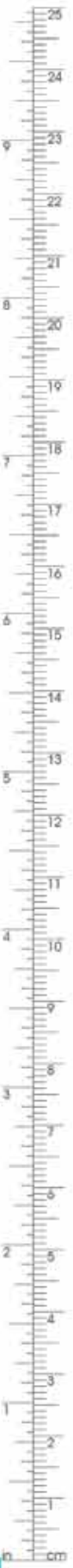

EE610-02 EE610-04



EE610-03 EE610-05



EE612-02
24 cm



EE612-01
22.5 cm



TÜBINGER
EE613-00
25.5 cm

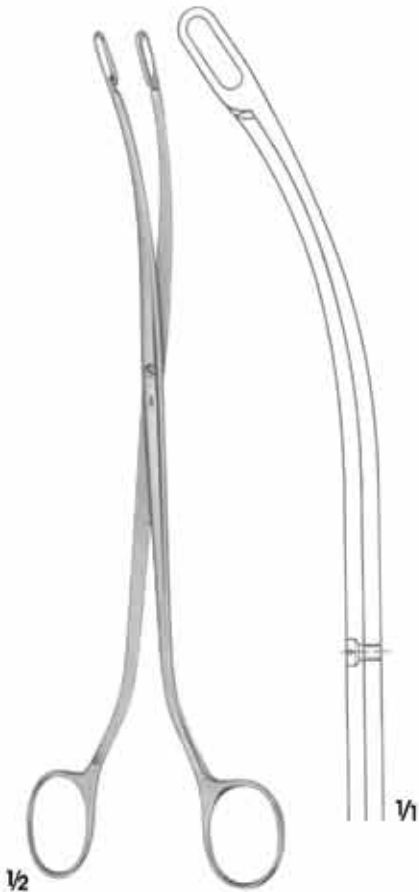

DESJARDINS
EE610-02-EE610-05
22.5 cm



DESJARDINS
EE612-01-EE612-02
Hassas model
Extremely delicate patterns

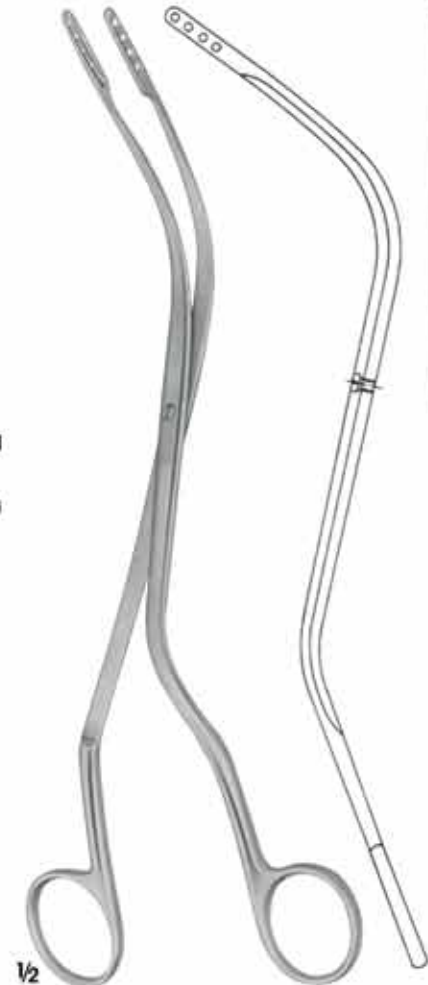

TÜBINGER
EE613-00
25.5 cm

EUR

Ürolojik Aletler

Genito-Urinary Instruments





EG459-00
19.5 cm



EG459-01
22 cm



EG459-02
23 cm



PEAN
EG459-00-EG459-02



GUYON
EG468-00
23.5 cm





STILLE
EG475-02
22 cm



STILLE
EG476-02
24 cm

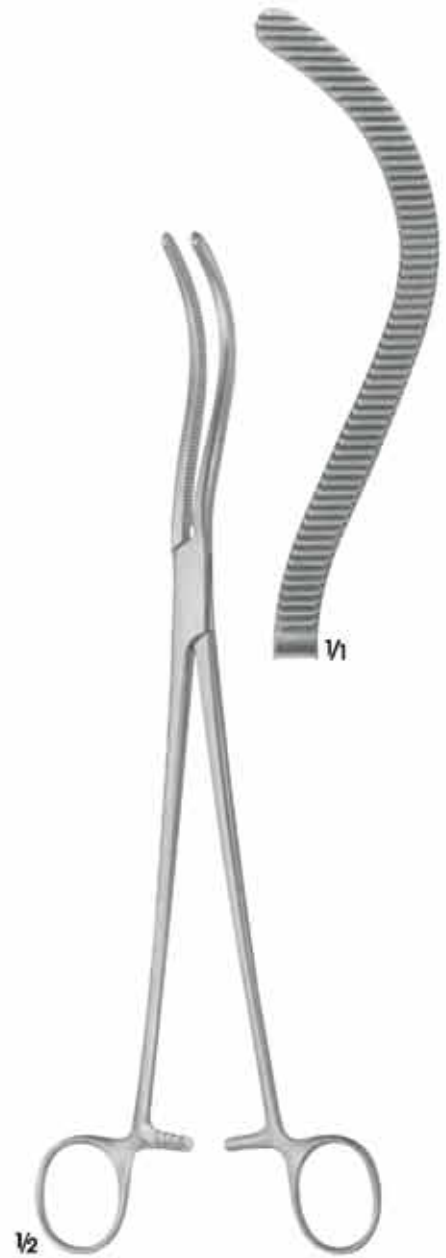

GUYON
EG478-02
26.5 cm

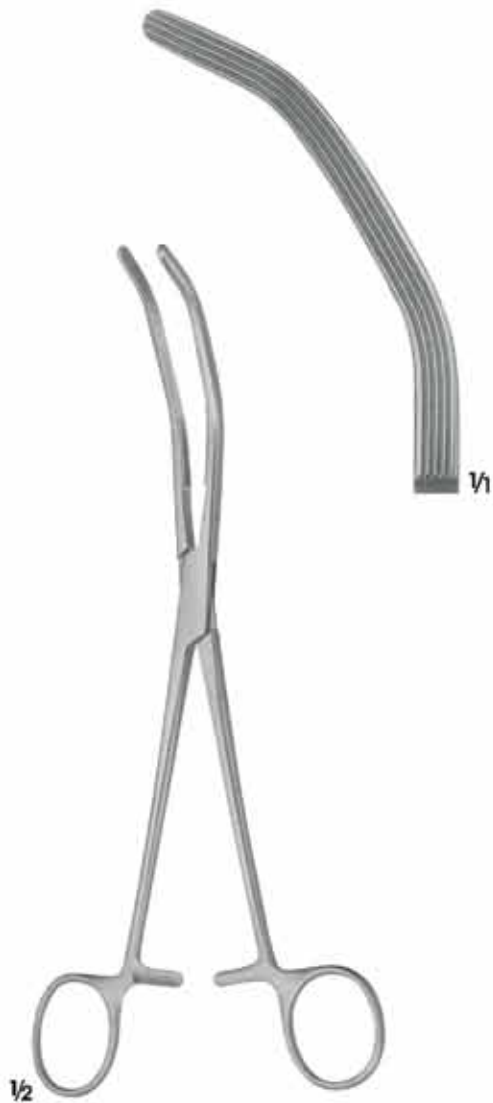

HERRICK
EG488-00
22.5 cm



WERTHEIM
EG760-00
25.5 cm

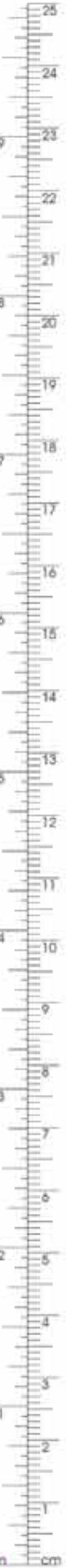

Atromatik
Atraumatic



WERTHEIM - CULLEN
EG771-00
Açılı baskı klempli
Angle- and pressure clamp
21.5 cm



WERTHEIM
EG770-00
Açılı baskı klempli
Angle- and pressure clamp
25 cm



DARTIGUES
EE575-02
25.5 cm



COLLIN
EE577-02
28.5 cm



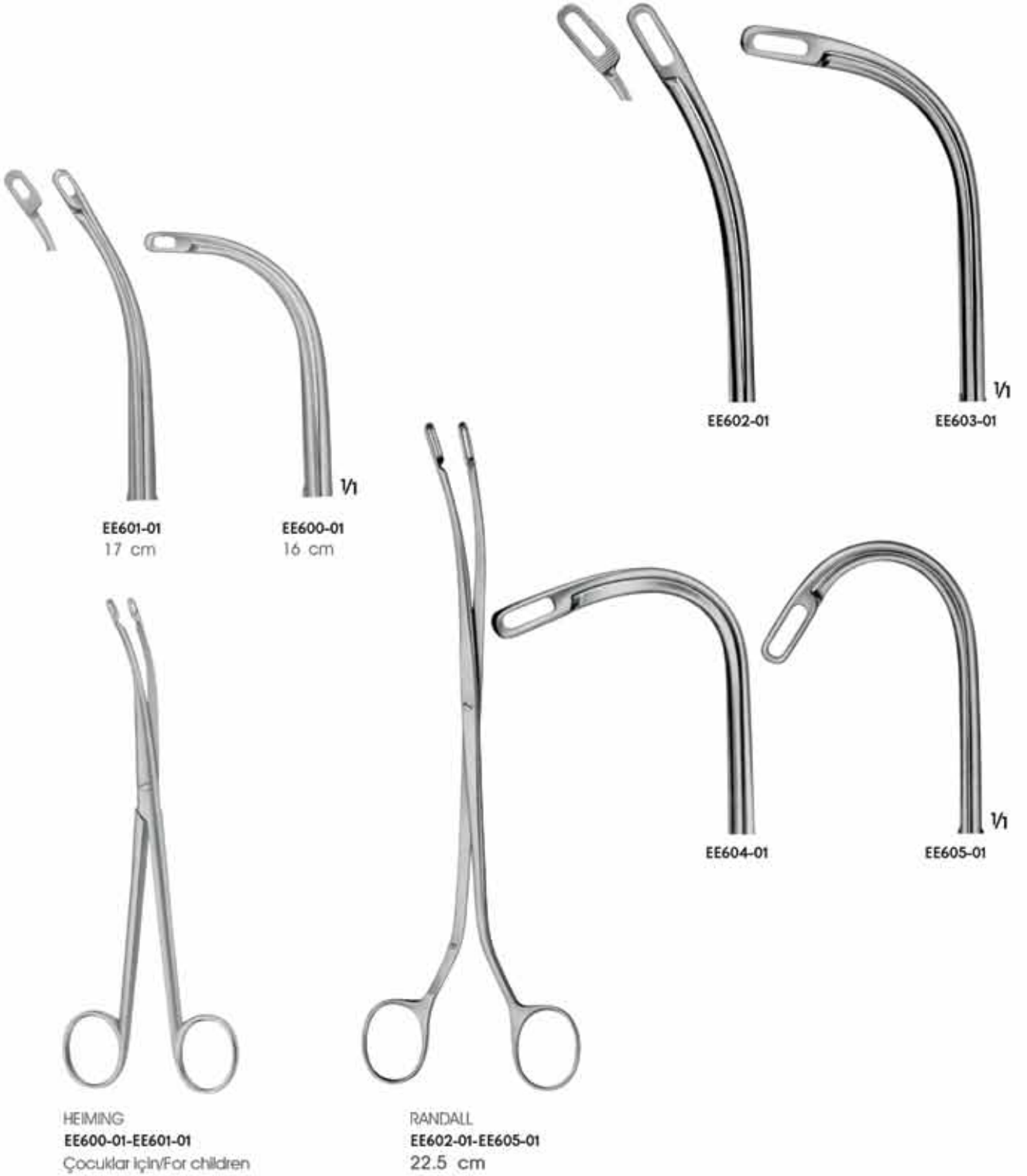



RANDALL
EE608-01-EE609-01
19 cm



RANDALL
EE614-01-EE615-01
Çok hassas model
Extremely delicate patterns

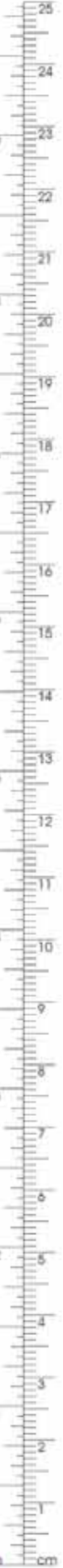



EL515-05
57 x 25 mm



EL515-05
57 x 25 mm



EL515-06
82 x 25 mm



EL515-06
82 x 25 mm

MILLIN

- EL515-00** Komple/Complete
- EL515-02** Sadece ekartör/Retractor only
- EL515-05** Bleyd 57 x 25 mm/Blades 57 x 25 mm
- EL515-06** Bleyd 82 x 25 mm/Blades 82 x 25 mm
- EL515-11** Orta bleyd 105 x 45 mm/Center blade 105 x 45 mm

MILLIN

- EL515-01** Komple/Complete
Işık taşıyıcı/With light carrier
- EL515-02** Sadece ekartör/Retractor only
- EL515-05** Bleyd 57 x 25 mm/Blades 57 x 25 mm
- EL515-06** Bleyd 82 x 25 mm/Blades 82 x 25 mm
- EL515-12** Orta bleyd 105 x 45 mm/Center blade 105 x 45 mm



KOCHER
EK722-00
Mesane ekartör
Bladder retractor
26 cm

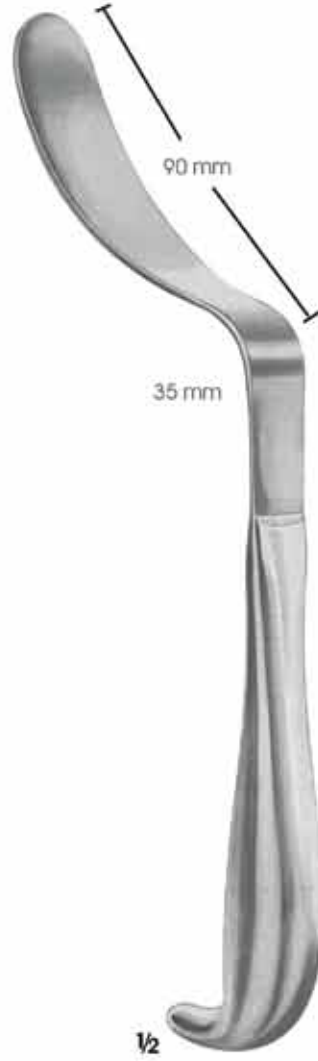

LEGUEU
EK723-00
Mesane spatula
Bladder spatula
26 cm



MILLIN
EL558-01
Mesane ayırıcı
Bladder neck spreader
28.5 cm



Atromatik
Atraumatic



Atromatik
Atraumatic

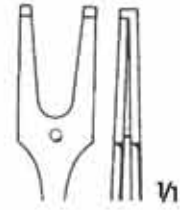

1/2

MILLIN
EE534-00
Lobe yakalama pensil
Lobe grasping forceps
23.5 cm



1/2

MILLIN
EE536-00
Lobe tutma pensil
Lobe grasping forceps
24.5 cm



1/2

MILLIN
EE408-00
Bağ tutucu pensil
Ligature holding forceps
24.5 cm



1/2
YOUNG
EK765-00
21 cm



1/2
YOUNG
EK768-00
21 cm



1/2
EK726-00
Prostat ekartör
Prostate retractor
36 cm



1/2
EK727-00
Üretral ekartör
Urethral retractor
39 cm





BARRE
EB035-00
No.3 XL
Sol el için
For left hand
25 cm



BARRE
EB036-00-EB036-01
No.3 XL
Sol el için
For left hand
25 cm



EB036-00
12°

EB036-01
25°



EF400-00



EF400-01



EF400-02



1/2

YOUNG-HRYNTSCHAK
EF406-00
1 iğne ile F 400.00
With 1 needle F 400.00
24 cm

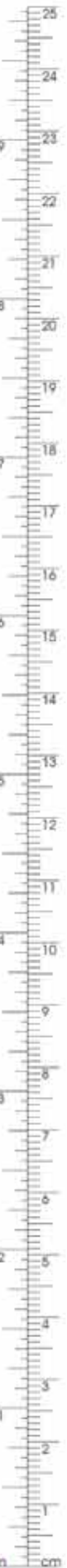



EP543-00
Ø 4.8 mm
Glans ve sünnet derisi
tutma pens
Forceps for grasping the glans
and the foreskin
12.5 cm



EP545-00
Testis sabitleme klempli
Fixation clamp for the
spermatic cord
14.5 cm

Atrometik
Atraumatic



EP171-00
Testis bağlayıcı huk
Hook for the spermatic cord
16.5 cm

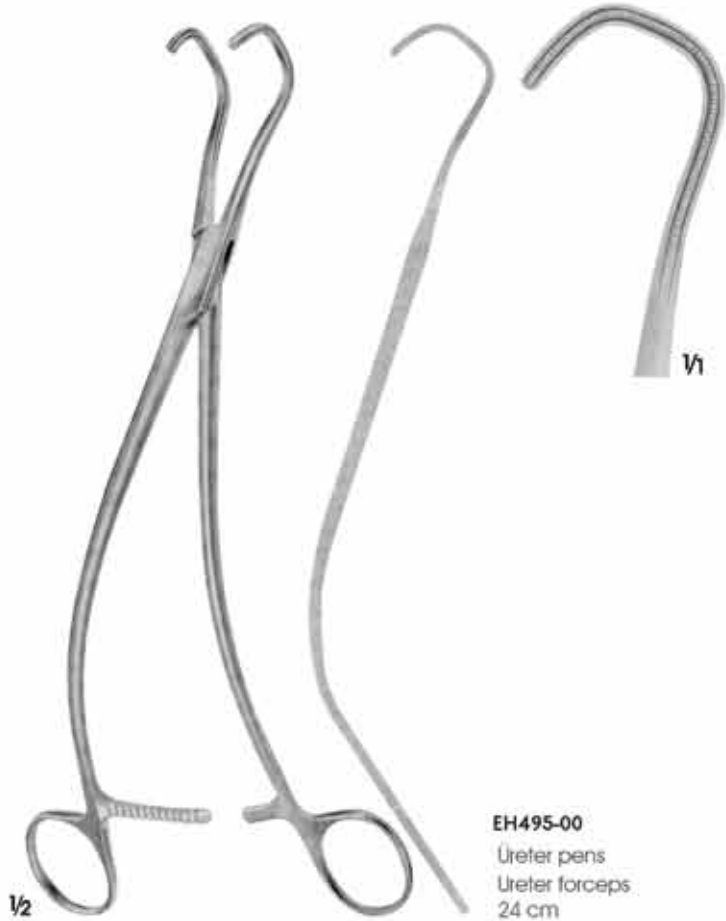

EH495-00
Üreter pens
Ureter forceps
24 cm

- İki adet hemostatik veya ligatür pens yardımı ile sünnet derisi çan şeklindeki koruma çubuğu üzerine çekilir ve glans yuvaya yerleştirilir.
 - Bu şekilde, kelebek somun sıkılarak, olabildiğince kapama sağlanır. Böylelikle sünnet derisi halka şeklinde sıkıştırılır. Sünnet derisi bistüri yardımı ile sıkma çemberinin hemen kenarından kesilir.
 - Sünnet çanı kanamayı önlemek amacı ile bir kaç dakika bekletilir. Özellikle frenular arter damarının büyük olması ve kesilmesi gerektiği durumlarda dikiş takımı hazır bulundurulmalıdır.
 - Tanımlanan metodun avantajı, küçük ölçü dokunun bıraktığı yara izinin estetik olarak uygun olmasıdır.
-
- Foreskin is pushed over the bell-shaped protection rod with the help of two hemostatic or ligature forceps and the glans is placed into cavity on the rod.
 - In this position, wing nut is tightened as close as possible for guaranteeing annular copression on the foreskin. Then foreskin is cut off with scalpel, right next to the compression ring.
 - The circumcision clamp is kept in compressed position for few minutes for avoiding bleeding. In case of large vein of frenular artery is cut artrey is cut through, the ligature set should be kept ready.
 - The advantage of the method described is aesthetically favorble scar after opretion.



WINKELMANN
ET465-00 Ø 12 mm
ET465-01 Ø 16 mm
ET465-02 Ø 20 mm
Sünnet klempleri
Circumcision clamps



STOCKMANN
ET460-00
Penis klempe
Penis clamp
7 cm



STRAUSS
ET461-00
Penis klempe
Penis clamp
13 cm





MATHIEU
ER800-00
Yabancı cisim pensi
Foreign body forceps
19 cm



PITHA
EE351-00
Yabancı cisim pensi
Foreign body forceps
22 cm



ASCH
EN585-01
Uterin kaşık küret, künf
Uterine secretion scoop, blunt
20 cm



EJ090-03-EJ090-09
Uterin sonda
Uterine probe
33 cm

	Char.
EJ090-03	3
EJ090-04	4
EJ090-05	5
EJ090-06	6



1/2

	Char.
EJ094-08	8
EJ094-10	10
EJ094-12	12
EJ094-14	14
EJ094-16	16
EJ094-18	18
EJ094-20	20

EJ094-08-EJ094-20
Erkekler için metal katater
Male catheters, metal
29 cm



1/1

	Char.
EJ095-06	6
EJ095-07	7
EJ095-08	8
EJ095-09	9
EJ095-10	10
EJ095-11	11
EJ095-12	12
EJ095-13	13
EJ095-14	14
EJ095-15	15
EJ095-16	16
EJ095-18	18
EJ095-20	20

EJ095-06-EJ095-20
Bayanlar için metal katater
Female catheters, metal
15.5 cm



1/4

EJ097-10
Katater kılavuz
Catheter guide
49 cm





1/3

GUYON
EJ098-02
Katater klavuz
Catheter guide
36.5 cm



1/3

EJ099-02
Katater için uygulayıcı
Introducer for catheters
46 cm



1/2

DITTEL
EJ080-08-EJ080-30
Üretral dilatasyon bujileri
Urethral dilating bougies
34.5 cm

Charr.

EJ080-08	8
EJ080-09	9
EJ080-10	10
EJ080-11	11
EJ080-12	12
EJ080-13	13
EJ080-14	14
EJ080-15	15
EJ080-16	16
EJ080-17	17
EJ080-18	18
EJ080-19	19
EJ080-20	20
EJ080-21	21
EJ080-22	22
EJ080-23	23
EJ080-24	24
EJ080-25	25
EJ080-26	26
EJ080-27	27
EJ080-28	28
EJ080-29	29
EJ080-30	30



1/2

GUYON
EJ092-24-EJ092-60
Uretral dilatasyon bujileri
Urethral dilating bougies
25.5 cm

- EJ092-24 Ben 24/ Char.12
- EJ092-26 Ben 26/ Char.13
- EJ092-28 Ben 28/ Char.14
- EJ092-30 Ben 30/ Char.15
- EJ092-32 Ben 32/ Char.16
- EJ092-34 Ben 34/ Char.17
- EJ092-36 Ben 36/ Char.18
- EJ092-38 Ben 38/ Char.19
- EJ092-40 Ben 40/ Char.20
- EJ092-42 Ben 42/ Char.21
- EJ092-44 Ben 44/ Char.22
- EJ092-46 Ben 46/ Char.23
- EJ092-48 Ben 48/ Char.24
- EJ092-50 Ben 50/ Char.25
- EJ092-52 Ben 52/ Char.26
- EJ092-54 Ben 54/ Char.27
- EJ092-56 Ben 56/ Char.28
- EJ092-58 Ben 58/ Char.29
- EJ092-60 Ben 60/ Char.30



1/2

TURNER WARWICK
EJ093-00
Gerici buji
Retrograde bougie
18 cm

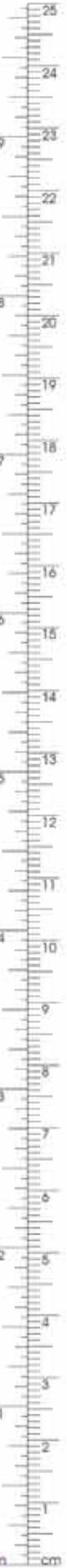

EJN

KJinekolojik Aletler

Gynaecolojik Instruments



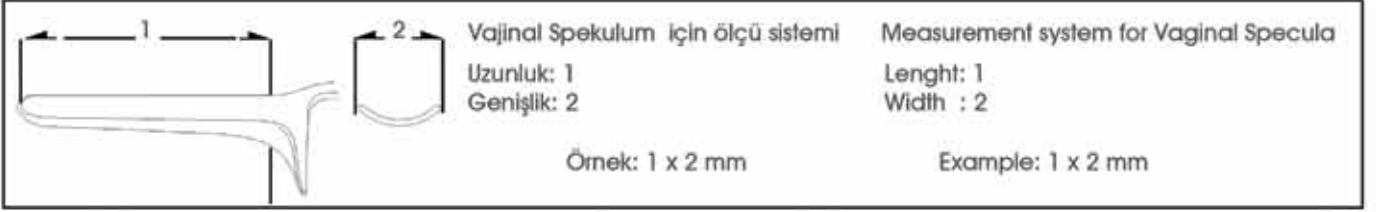

COLLIN
EL750-01
53 x 10 mm
Çocuklar için/For children



COLLIN
EL752-01
95/85 x 18 mm
Bakireler için/For virgins



COLLIN	Tam boy/Çalışma boy Total length/Working length	En Width
EL754-01	100/90 mm	28 mm
EL754-02	100/90 mm	32 mm
EL754-03	105/95 mm	35 mm
EL754-04	115/105 mm	40 mm



TRELAT	
EL785-01	85 x 33 mm
EL785-02	95 x 35 mm
EL785-03	115 x 43 mm



CUSCO
EL760-01
75 x 17 mm
Bakireler için/For virgins



CUSCO
EL770-01
75 x 17 mm
Bakireler için/For virgins



CUSCO STANDARD
EL762-01 80 x 24 mm
EL762-02 80 x 32 mm
EL762-03 90 x 36 mm
EL762-04 110 x 37 mm
Standart model
Standard patterns



İsviçre örneği
Özellikleri: Uzun ve dar
Swiss patterns
Features: Long and narrow

CUSCO
EL763-01 92 x 23 - 25 mm
EL763-02 100 x 25 - 27 mm
EL763-03 110 x 27 - 30 mm





CUSCO
EL765-01 80 x 32 mm
EL765-02 90 x 37 mm
EL765-04 115 x 37 mm
Yassı (Ördek gagası)
Flat (Duck beak)



CUSCO
EL771-01 80 x 24 mm
EL771-02 80 x 32 mm
EL771-03 90 x 36 mm
EL771-04 110 x 37 mm
Aspiratör uçsuz/Without suction tube
EL771-05 107 x 29 mm
EL771-06 115 x 35 mm
Aspiratör uçlu/With suction tube



GRAVE
EL790-01 75 x 20 mm
EL790-02 95 x 30 mm
EL790-03 105 x 33 mm



PEDERSON
EL791-01 100 x 22 mm
EL791-02 120 x 25 mm

Parmak baskısıyla açılıp kapanan çift işarelli
With double ratchet, closing and opening of
ratchet by pressure of thumb

SEMM
EL780-01
90 x 14 - 18 mm
Çocuk ve bakireler için
For children and virgins



Parmak baskısıyla açılıp kapanan çift işarelli
With double ratchet, closing and opening of
ratchet by pressure of thumb

SEMM
EL781-01 100 x 20 - 24 mm
EL781-05 100 x 30 - 34 mm
18,5 cm



SEYFFERT
EL782-01 100 x 17 mm
EL782-05 100 x 33 mm
23 cm

Alet ve kataterleri çıkarmak için bir tarafı açık
One side open for taking up instruments and
catheters

SEYFFERT
EL783-01 110 x 33 mm
23 cm



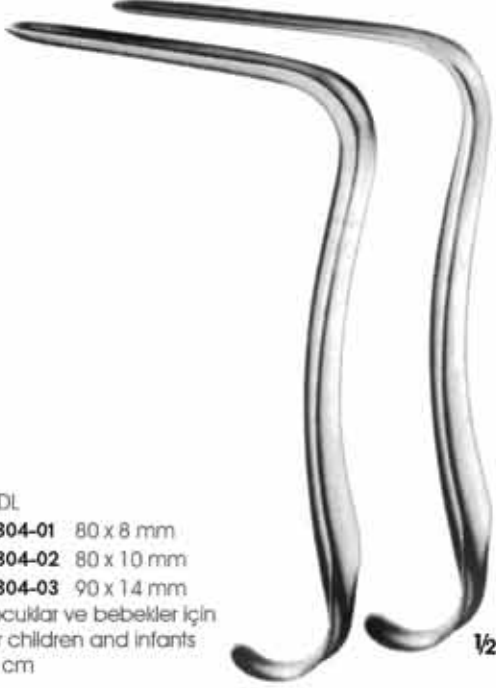

KRISTELLER
EK814-00-EK814-03
Üst bleyd/Upper blades



EK814-00
75 x 10 mm
17.5 cm



EK814-01
75 x 23 mm
18 cm



EK814-02
80 x 25 mm
18 cm



EK814-03
100 x 32 mm
18.5 cm



1/2

KRISTELLER
EK812-00-EK812-03
Alt bleyd/Lower blade



EK812-00
70 x 15 mm
17.5 cm



EK812-01
70 x 27 mm
18 cm



EK812-02
75 x 30 mm
18 cm



EK812-03
90 x 36 mm
18.5 cm



1/2





KRISTELLER
EK814-04-EK814-08
Üst bleyd/Upper blades

EK814-04
115 x 14 mm
21.5 cm

EK814-05
115 x 23 mm
21.5 cm

EK814-06
115 x 16 mm
22 cm

EK814-07
115 x 26 mm
22 cm

EK814-08
120 x 30 mm
22.5 cm



1/2



KRISTELLER
EK812-04-EK812-08
Alt bleyd/Lower blades

EK812-04
110 x 18 mm
21.5 cm

EK812-05
110 x 27 mm
21.5 cm

EK812-06
110 x 20 mm
22 cm

EK812-07
110 x 30 mm
22 cm

EK812-08
110 x 36 mm
22.5 cm



1/2



KRISTELLER
EK817-02-EK817-04
Üst bleyd/Upper blades
20.5 cm

1/2

EK817-02
80 x 28 mm



EK817-03
85 x 35 mm



EK817-04
85 x 40 mm



1/2



JACKSON
EK819-02-EK819-04
Alt bleyd/Lower blades

1/2

EK819-02
76 x 38 mm



EK819-03
89 x 38 mm



EK819-04
102 x 38 mm



1/2

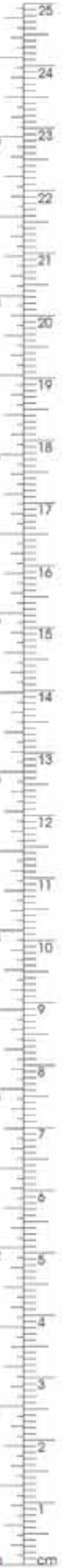



KALLMORGEN
EK825-01 Set/Set
75 x 39 mm
17 cm

1/2



KALLMORGEN
EK826-01 Set/Set
95 x 39 mm
20 cm

1/2



SIMS
EK832-01 70 x 26 / 75 x 30 mm
12.5 cm
EK832-05 75 x 30 / 80 x 35 mm
15 cm
EK832-08 80 x 36 / 90 x 40 mm
17.5 cm

1/2



BREISKY
EK830-01 72 x 25 / 77 x 30 mm
14 cm
EK830-05 75 x 30 / 92 x 38 mm
17 cm

1/2

EK841-03
110 x 20 mm



EK841-04
110 x 30 mm



EK841-05
110 x 36 mm



EK841-03-EK841-05
Alt bıyık/Lower blade
21,5 cm

EK841-06
115 x 18 mm



EK841-07
115 x 26 mm



EK841-08
115 x 32 mm



KRISTELLER
EK841-00 110 x 20 mm
EK841-01 110 x 30 mm
EK841-02 110 x 36 mm
Viyana model set
Vienna patterns sets

1/2



KRISTELLER
EK841-06-EK817-08
Üst bıyık/Upper blade
22 cm

1/2





1/2
BRAUN
EK850-01
56 x 13 mm
18 cm



1/2
BRAUN
EK851-01
60 x 10 mm
18 cm



1/2
HEANEY
EK815-00
89 x 29 mm
17 cm



1/2
EASTMAN
EK818-00
89 x 38 mm
17.5 cm



1/2
LANDON
EK854-00
89 x 25 mm
19.5 cm



1/2
MATHIEU
EK843-01
İç bıyık/inner blade
95 x 17 - 30 mm
21 cm



1/2
MATHIEU
EK844-01
Üst bıyık/Upper blade
95 x 17 - 26 mm
(İç bıyık/inner blade K 843.01)
21 cm

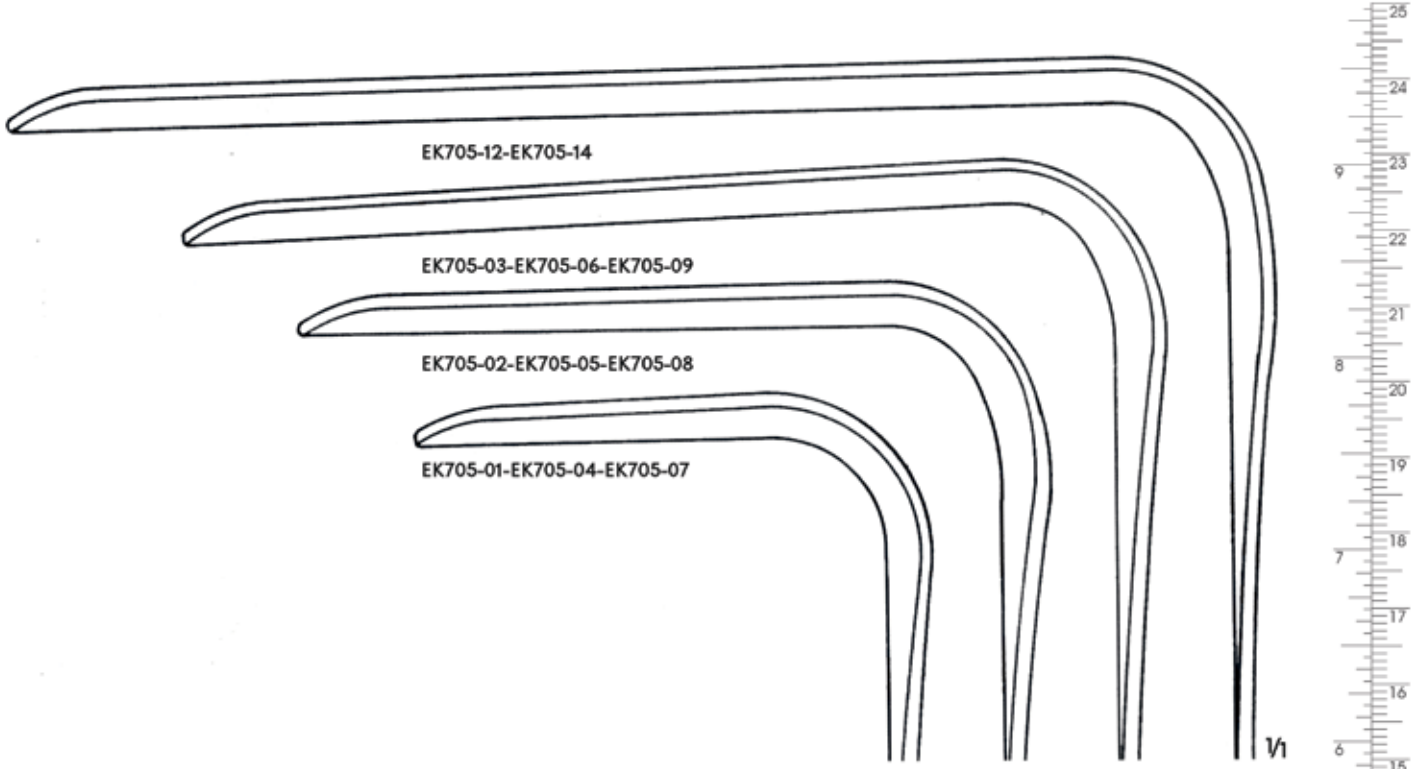

DOYEN
EK705-01-EK705-14
24 cm

Ağız uzunluğu Length of blades	Ağız genişlikleri Width of blades		
60 mm	EK705-01	EK705-04	EK705-07
90 mm	EK705-02	EK705-05	EK705-08
120 mm	EK705-03	EK705-06	EK705-09
160 mm	-	EK705-12	EK705-14



LANDAU
EK680-02 100 x 28 mm
EK680-04 110 x 38 mm
29 cm

1/2



BREISKY
EK682-02 100 x 20 mm
EK682-03 100 x 25 mm
EK682-04 100 x 30 mm
EK682-05 100 x 35 mm
EK682-06 100 x 40 mm
Viyana Model
Vienna patterns
30 cm

1/2



BREISKY
EK683-02 130 x 20 mm
EK683-03 130 x 25 mm
EK683-04 130 x 30 mm
EK683-05 130 x 35 mm
EK683-06 130 x 40 mm
Viyana Model
Vienna patterns
32 cm

1/2



BREISKY
EK684-02 160 x 40 mm
EK684-03 180 x 40 mm
Viyana Model
Vienna patterns
35 cm

1/2







WEISSBARTH
EK868-01 80 x 28 mm
EK868-02 85 x 42 mm
21 cm

EK868-03
Sökülebilir süzgeçli
Removable strainer only

1/2



ALVARD
EK864-00
65 x 38-28 mm
1.530 gr.
Sökülebilir ağırlıklı
With detachable weight
23 cm

1/2



ALVARD
EK863-01 75 x 42-40 mm
EK863-02 105 x 43-40 mm
1.470 gr. sökülebilir ağırlıklı
With detachable weight
23 cm

1/2



ALVARD
EK862-01
65 x 38-28 mm
1.530 gr.
Sabit ağırlık
Fixed weight
23 cm

1/2





(K 735.10-K 735.16 ve K 735.20-K 735.27) birbirleriyle deđiřtirilebilir.
(K 735.08 ve K 735.09) saplarına okuduđu gibi (K 735.01) yada uyar.
The mentioned blades (K 735.10-K 735.16 and K 735.20-K 735.27)
can be exchanged. They fit handle K 735.01 as well as handles
K 735.08 and K 735.09.

SCHERBACK
T 791.00 Komple/Complete
(K 735.01) Sap/Handle
(T 790.00) Ađırlık/Weight
(K 735.10-K 735.15)4 Bleyd/4 Blades

1/3



BOZEMANN
EK735-30 Set/Set
(K 735.08-K 735.09) 2 Sap/2 Handles
(K 735.20-K 735.27) 8 Bleyd/8 Blades



GELPI
EL408-00
13.5 cm



GELPI
EL409-00
17.5 cm



RICHTER
EL412-00
17 cm



JOLL (FRIEDMANN)
EL417-00
15.5 cm

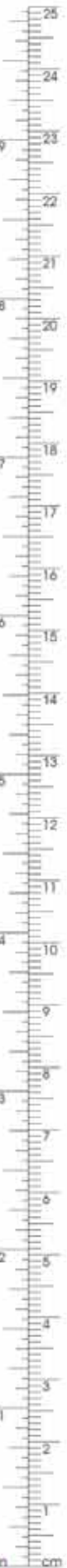



HEGAR
EK750-01-EJ751-17
Sivri uçlu dilatörler
With very conical point
18.5 cm

EJ750-01	1 mm	EJ750-14	14 mm	EJ751-01	1.5 mm	EJ751-14	14.5 mm
EJ750-02	2 mm	EJ750-15	15 mm	EJ751-02	2.5 mm	EJ751-15	15.5 mm
EJ750-03	3 mm	EJ750-16	16 mm	EJ751-03	3.5 mm	EJ751-16	16.5 mm
EJ750-04	4 mm	EJ750-17	17 mm	EJ751-04	4.5 mm	EJ751-17	17.5 mm
EJ750-05	5 mm	EJ750-18	18 mm	EJ751-05	5.5 mm		
EJ750-06	6 mm	EJ750-19	19 mm	EJ751-06	6.5 mm		
EJ750-07	7 mm	EJ750-20	20 mm	EJ751-07	7.5 mm		
EJ750-08	8 mm	EJ750-21	21 mm	EJ751-08	8.5 mm		
EJ750-09	9 mm	EJ750-22	22 mm	EJ751-09	9.5 mm		
EJ750-10	10 mm	EJ750-23	23 mm	EJ751-10	10.5 mm		
EJ750-11	11 mm	EJ750-24	24 mm	EJ751-11	11.5 mm		
EJ750-12	12 mm	EJ750-25	25 mm	EJ751-12	12.5 mm		
EJ750-13	13 mm	EJ750-26	26 mm	EJ751-13	13.5 mm		



HEGAR
EJ754-01-EJ754-09
19.5 cm

EJ754-01	1 + 2 mm
EJ754-02	3 + 4 mm
EJ754-03	5 + 6 mm
EJ754-04	7 + 8 mm
EJ754-05	9 + 10 mm
EJ754-06	11 + 12 mm
EJ754-07	13 + 14 mm
EJ754-08	15 + 16 mm
EJ754-09	17 + 18 mm



PRATT
EJ756-01-EJ756-08
29 cm

EJ756-01	13 - 15 Charr.
EJ756-02	17 - 19 Charr.
EJ756-03	21 - 23 Charr.
EJ756-04	25 - 27 Charr.
EJ756-05	29 - 31 Charr.
EJ756-06	33 - 35 Charr.
EJ756-07	37 - 39 Charr.
EJ756-08	41 - 43 Charr.

EJ790-00

Set (J 750.04-J 750.17) 14 parça
Set (J 750.04-J 750.17) 14 piece
Y 310.10WV 1 adet, Y 380.03F 1 adet, Y 840.00 15 adet,
Y 841.01 1 adet, Y 842.00 2 adet dahildir.
With Y 310.10WV 1 each, Y 380.03F 1 each,
Y 840.00 15 each, Y 841.01 1 each,
Y 842.00 2 each.

EJ790-01

Set (J 751.04-J 751.17) 14 parça
Set (J 751.04-J 751.17) 14 piece
Y 310.10WV 1 adet, Y 380.03F 1 adet, Y 840.00 15 adet,
Y 841.01 1 adet, Y 842.00-2 adet dahildir.
With Y 310.10WV 1 each, Y 380.03F 1 each, Y 840.00 15
each, Y 841.01 1 each, Y 842.00 2 each.

EJ792-00

Tam set 28 parça/Full set 28 piece
Set (J 750.04-J 750.17)+(J 751.04-J 751.17)
Y 110.10WV 1 adet, Y 181.05F 1 adet, Y 840.00 31 adet,
Y 841.01 1 adet, Y 842.00 2 adet dahildir.
With Y 110.10WV 1 each, Y 181.05F 1 each, Y 380.03F
1 each, Y 840.00 15 each, Y 841.01 1 each, Y 842.00
2 each.

EY841-00 230 mm

EY841-01 470 mm

Y 840.00 bölücü için sürgülü
ray, güvenlik vidaları ile
Sliding rails with securing
screws, for divider Y 840.00

EY842-00 230 mm

EY842-01 470 mm

Sınırlayıcı kalıp, güvenlik vidaları
ile özellikle depolama dilatörü
için uygun
Limiting bars with securing
screws, particularly useful for
storing dilators

EY840-00

Bölücü, Y 841.00 için
Divider, to be used with Y 841.00



Konteyner/Container



EY310-10WV	285 x 280 x 100 mm
EY310-13WV	285 x 280 x 135 mm
EY310-15WV	285 x 280 x 150 mm
EY310-20WV	285 x 280 x 200 mm
EY310-26WV	285 x 280 x 260 mm

Konteyner/Container



EY110-10WV	580 x 280 x 100 mm
EY110-13WV	580 x 280 x 135 mm
EY110-15WV	580 x 280 x 150 mm
EY110-20WV	580 x 280 x 200 mm
EY110-26WV	580 x 280 x 260 mm

Tel sepetler/Wire baskets



EY380-03F	242 x 252 x 40 mm
EY380-05F	242 x 252 x 60 mm
EY380-07F	242 x 252 x 80 mm
EY380-10F	242 x 252 x 110 mm

Tel sepetler/Wire baskets



EY181-03F	539 x 252 x 40 mm
EY181-05F	539 x 252 x 60 mm
EY181-07F	539 x 252 x 80 mm
EY181-10F	539 x 252 x 110 mm

Tel taban/Wire Base



EY393-00	258 x 258 x 30 mm
-----------------	-------------------

Tel taban/Wire Base

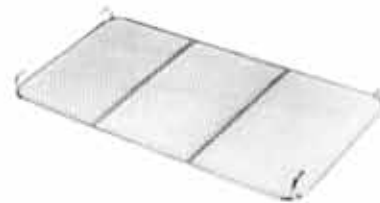

EY193-00	545 x 255 x 30 mm
-----------------	-------------------

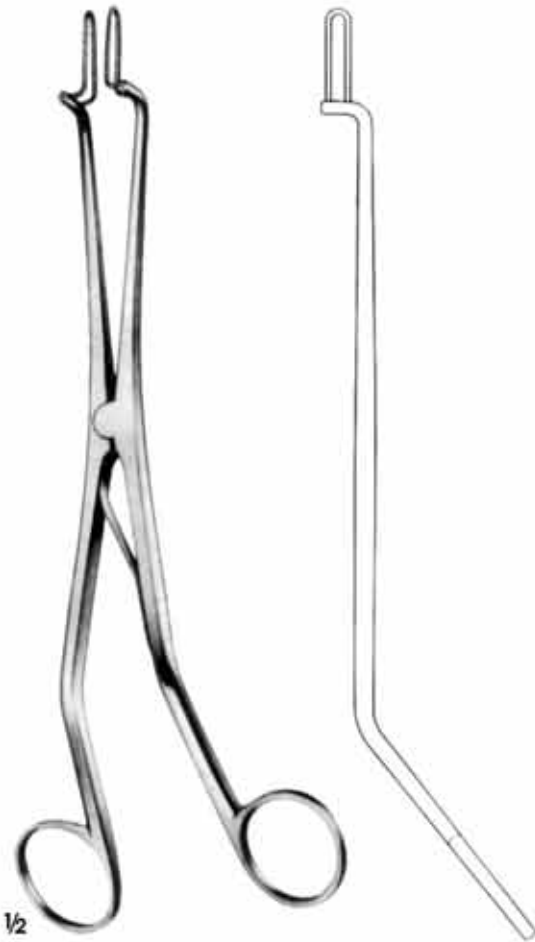

KOGAN
EY400-01
Kılıtsız/Without ratchet
24 cm

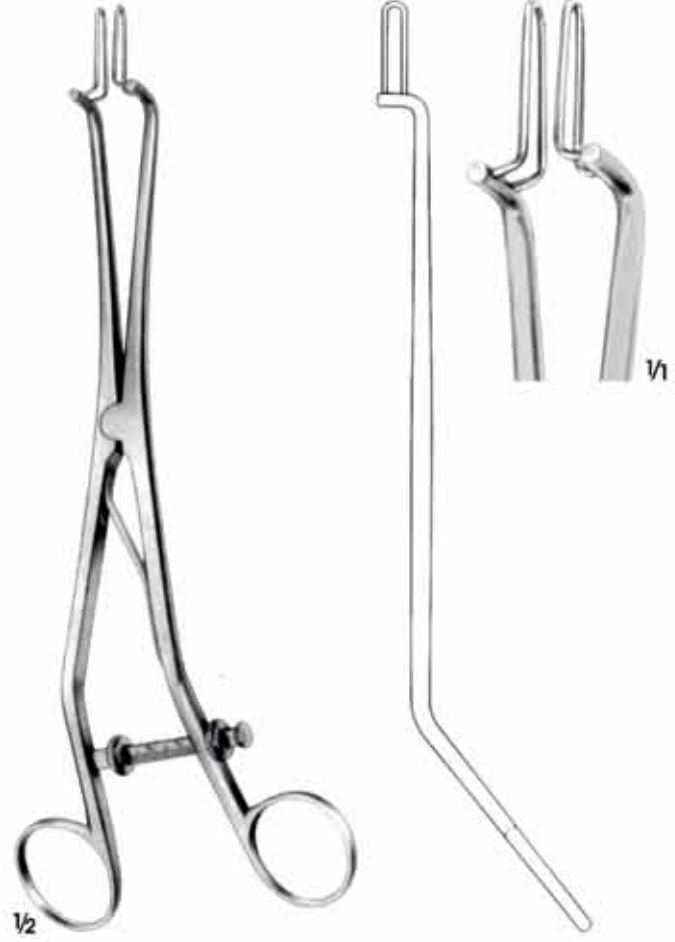

KOGAN
EY401-01
Ölçülü sabitleyici ayar vidası
With scale-ratchet and fixing screw
24 cm



Ø 5 mm



1/2

MAYO
EJ650-05
Bükülebilir/Malleable
33 cm

Ø 4 mm



1/2

SIMS
EJ652-05 33 cm
EJ652-08 33 cm
Bükülebilir/Malleable

Ø 3 mm



1/2

EJ653-05
30 cm

Ø 4 mm



1/2

SIMPSON
EJ656-05
Bükülebilir/Malleable
31 cm

Ø 3.6 mm



1/2

GALABINS
EJ654-00

Ölçülü mil, bükülebilir
Shaft graduated in cm, malleable
29.5 cm

Ø 4 mm



1/2

VALLEIX
EJ658-05

Ölçü kaydırıcı, göstergeli
Graduated, with slider
25 cm

24 mm



28 mm

1/2

BRAUN
EK390-03

Uterin bastırıcı
Uterine depressor
27 cm



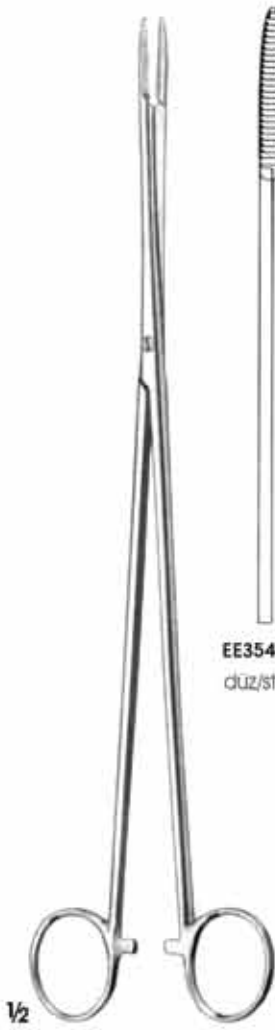

EE354-00
düz/straight

EE355-00
eğil/curved

PELKMANN
EE354-00-EE355-00
26 cm

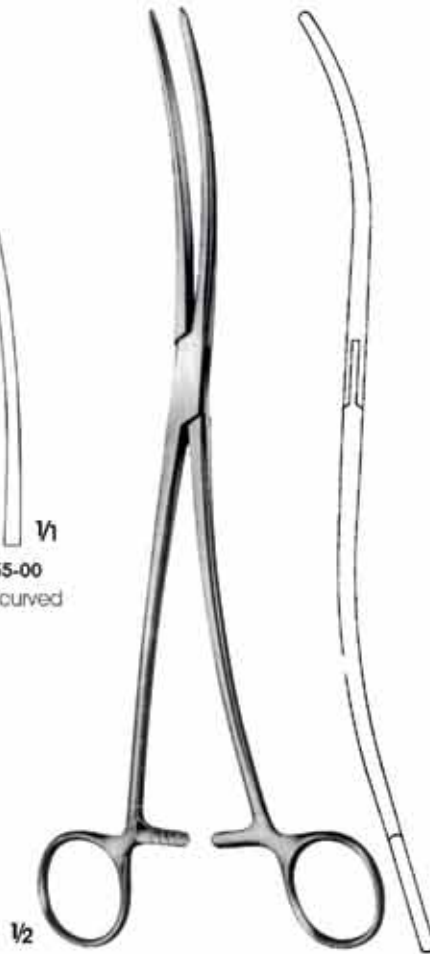

BOZEMANN
EE360-02
25 cm

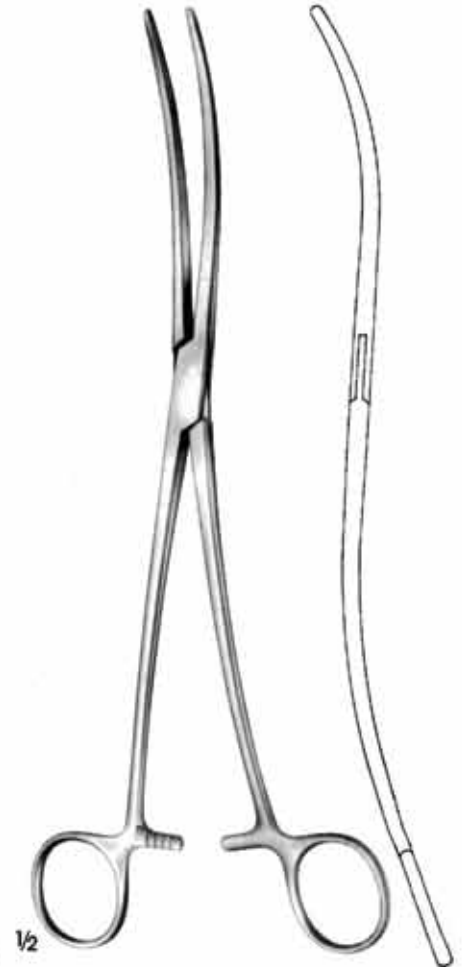

BOZEMANN
EE362-02
Ağız oluklu pens
Jaws with longitudinal
groove
25.5 cm



BOZEMANN
EE364-02-EE365-02



EE364-02
26 cm



EE365-02
25 cm

V1



BOZEMANN-DOUGLAS
EE367-02
26 cm

V2

V1



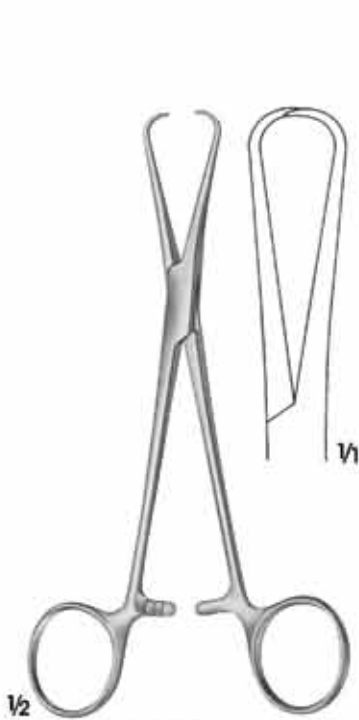

BERNHARD
EE444-00
16 cm

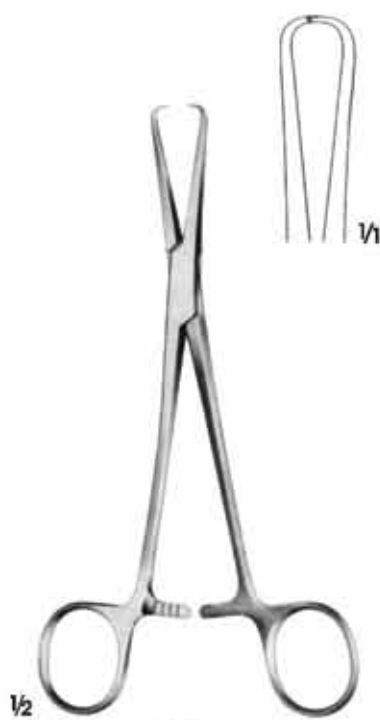

POZZI
EE445-01
17.5 cm

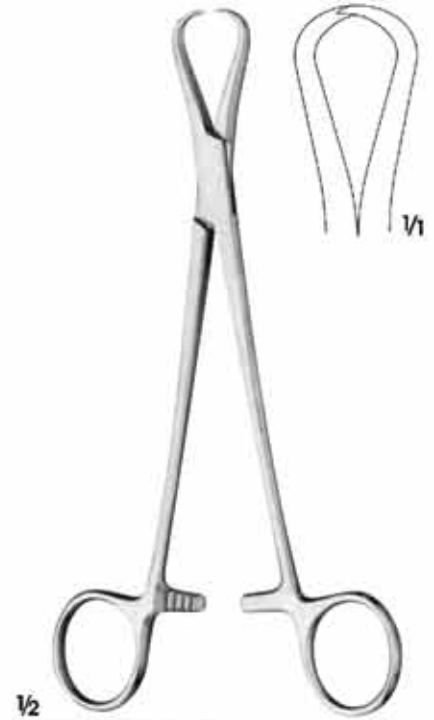

ADAIR
EE443-00
19 cm



BRAUN
EE258-01
Narin Model/Siender pattern
25 cm



COLLIN-POZZI
EE270-01
25 cm

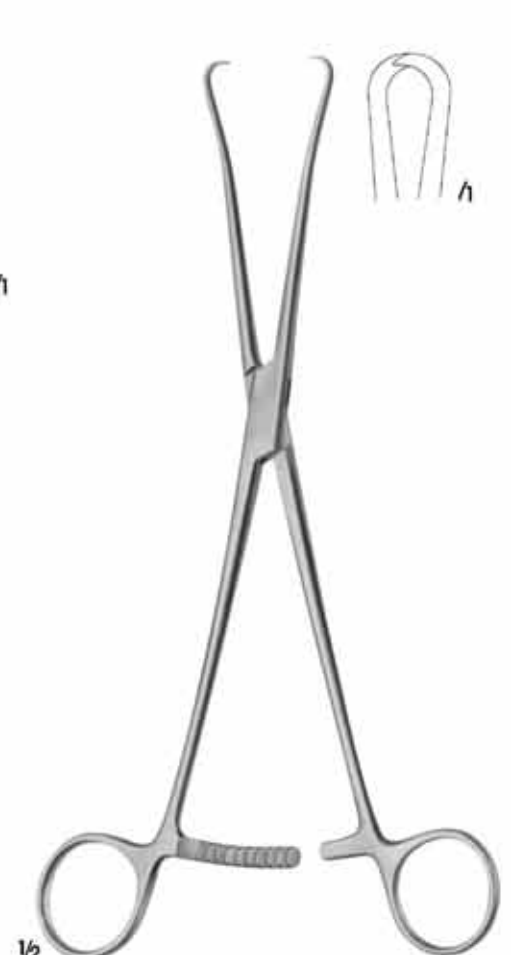

WILSON
EE252-00
24 cm



SCHRÖDER
EE251-00
Standart Model
Standart pattern
25 cm



SCHRÖDER
EE253-01
25 cm



POZZI
EE255-01
Zorlu operasyon için
Heavy pattern
25.5 cm



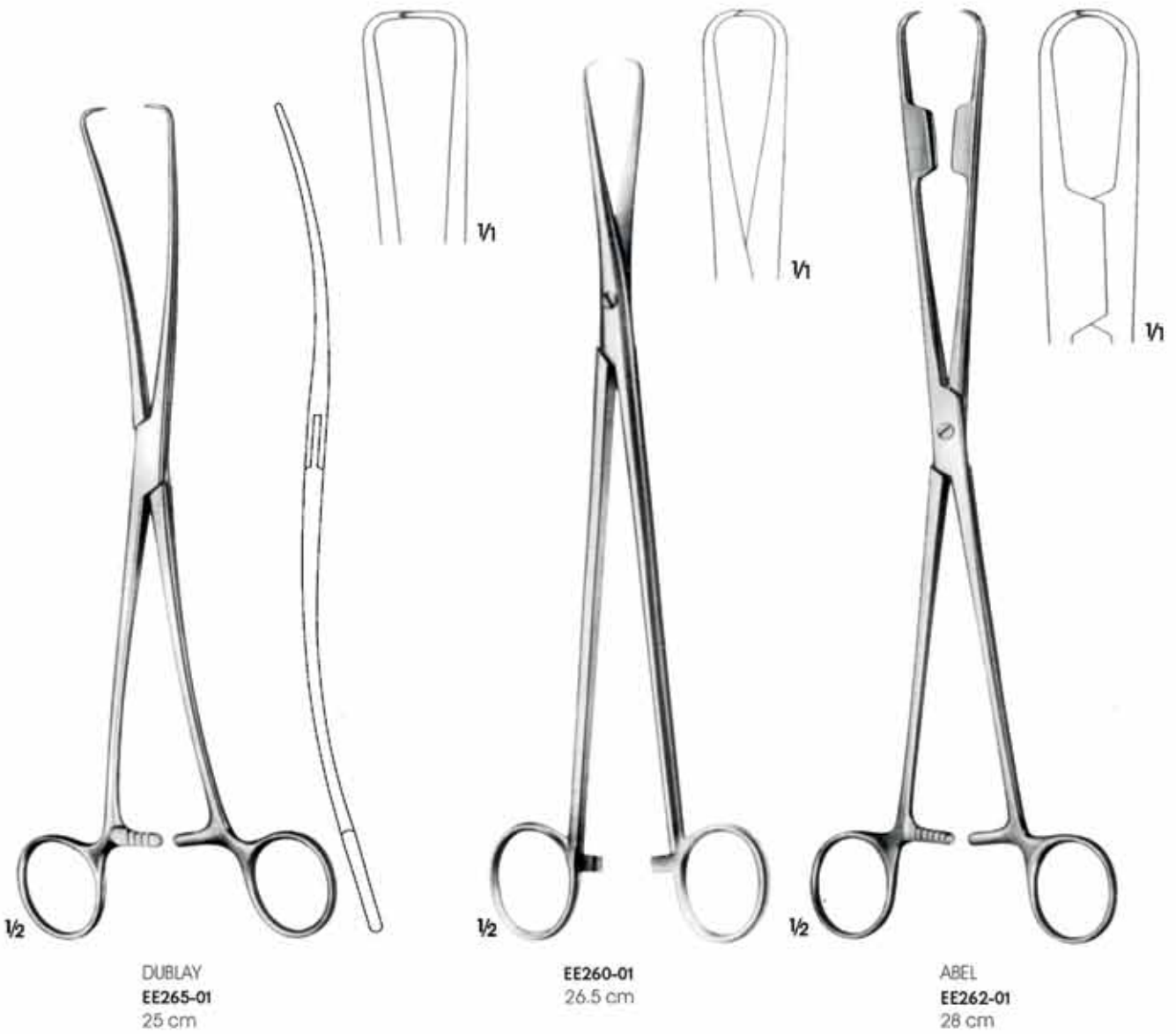



MUSEUX
EE375-01
20 cm



JACOBS
EE376-01
21.5 cm



MUSEUX
EE380-02-EE380-04
24 cm



MUSEUX
EE381-02-EE381-04
26.5 cm





LITTLEWOOD
EE378-02
18.5 cm



TEALE
EE379-002
25.5 cm



MUSEUX
EE382-02-EE382-04
Yana eğil
Curved to side
24 cm



KISTNER
EE383-02
25 cm

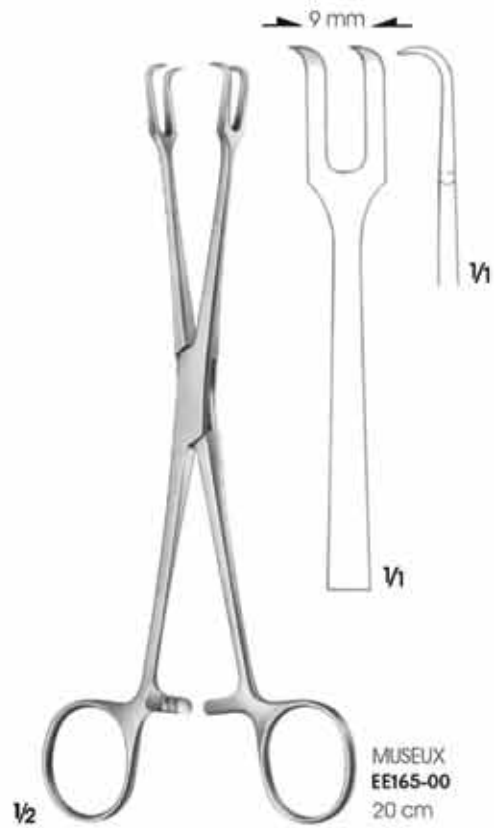
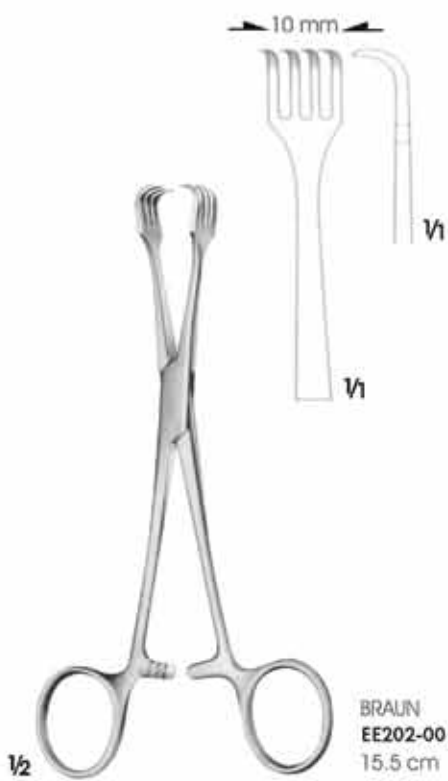
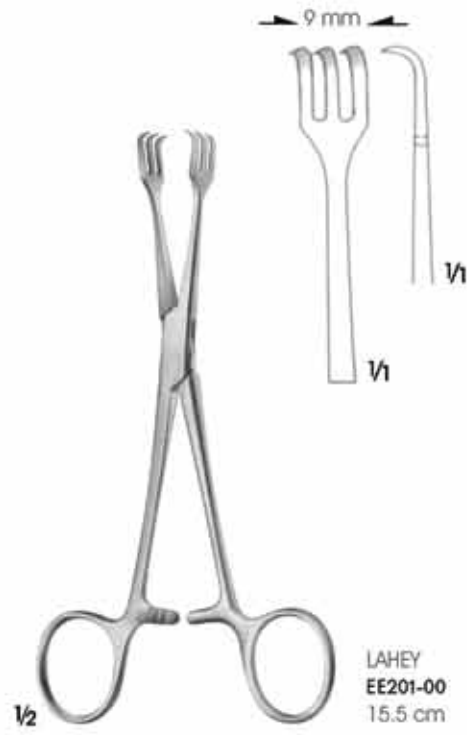
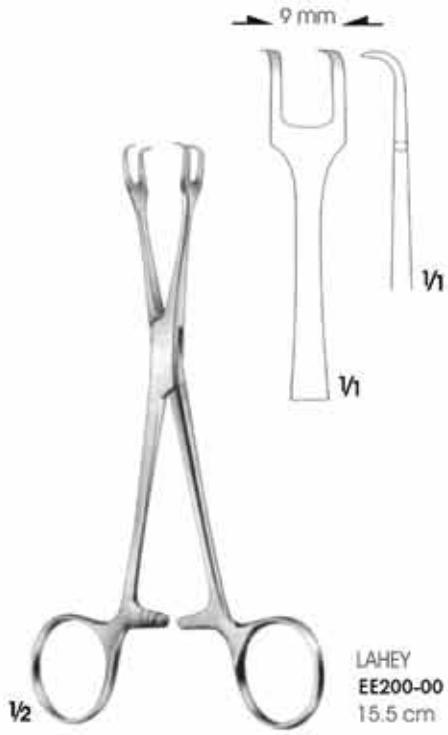

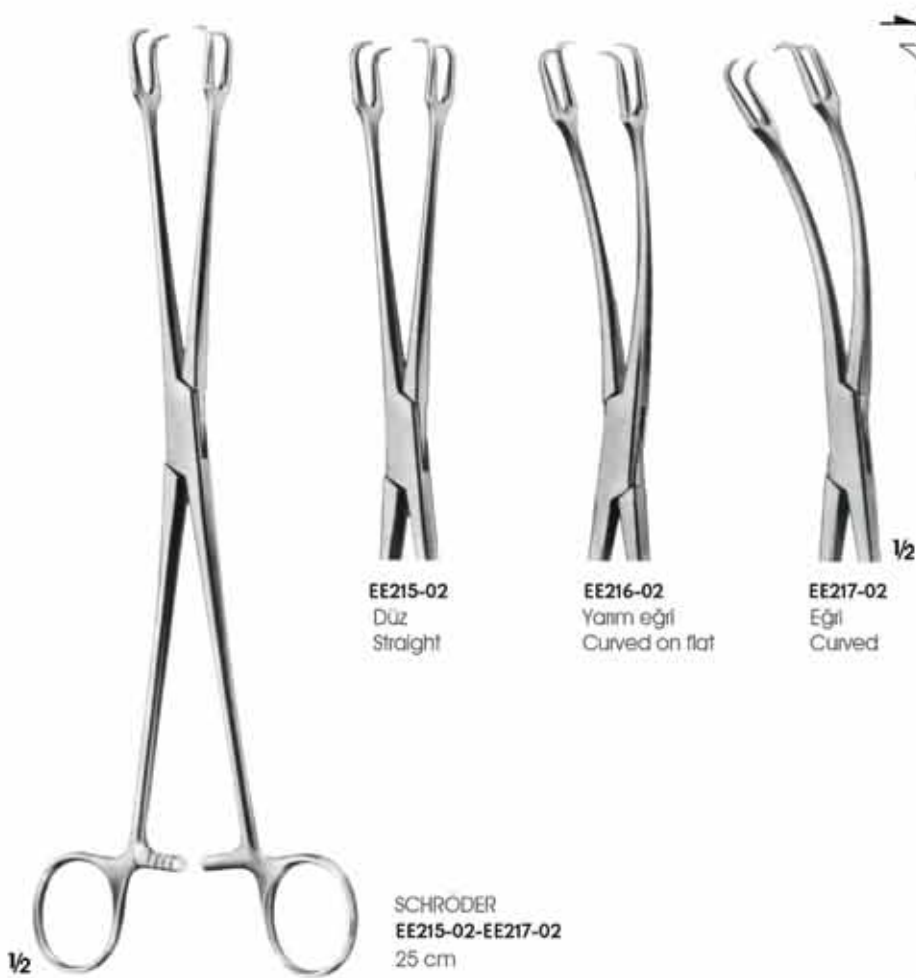
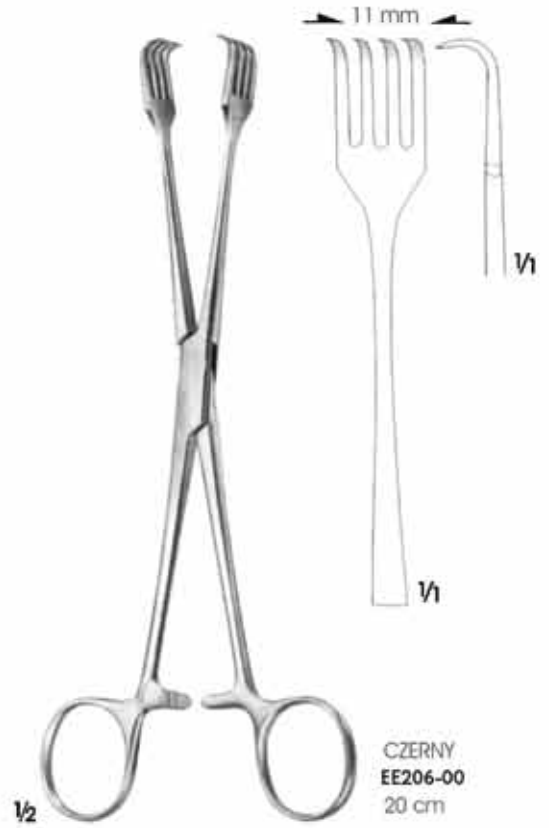
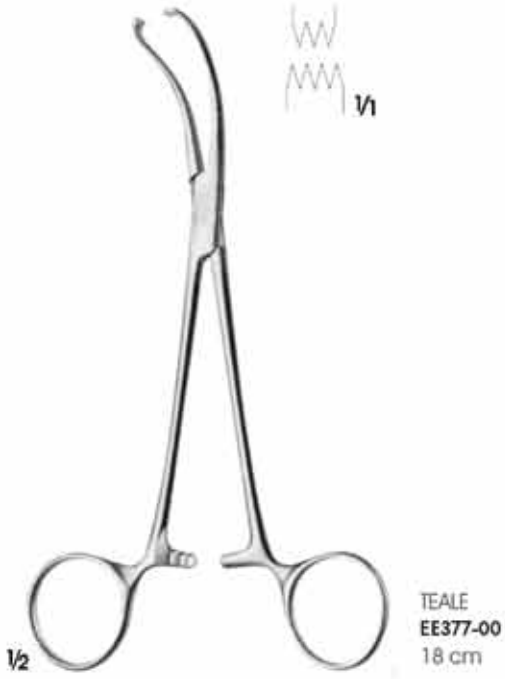

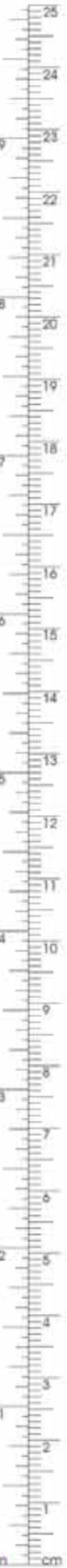
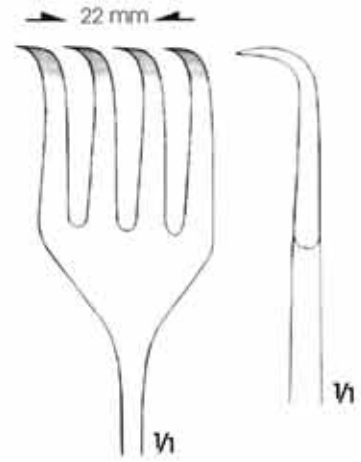
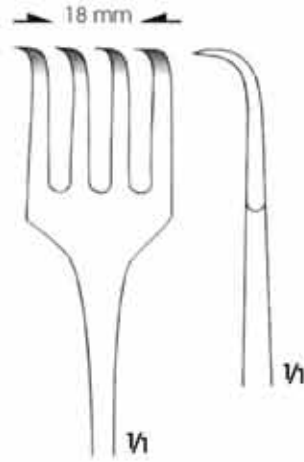
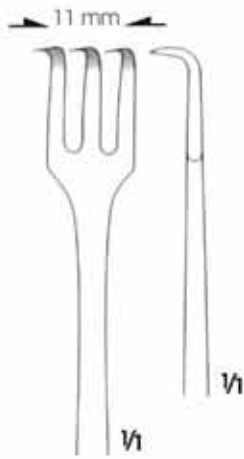

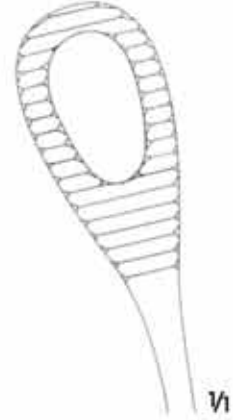
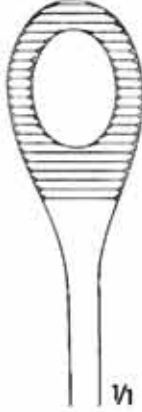

1/2

HEYWOOD-SMITH
EE198-00
25 cm



1/2

NOTO
EE120-00
28 cm

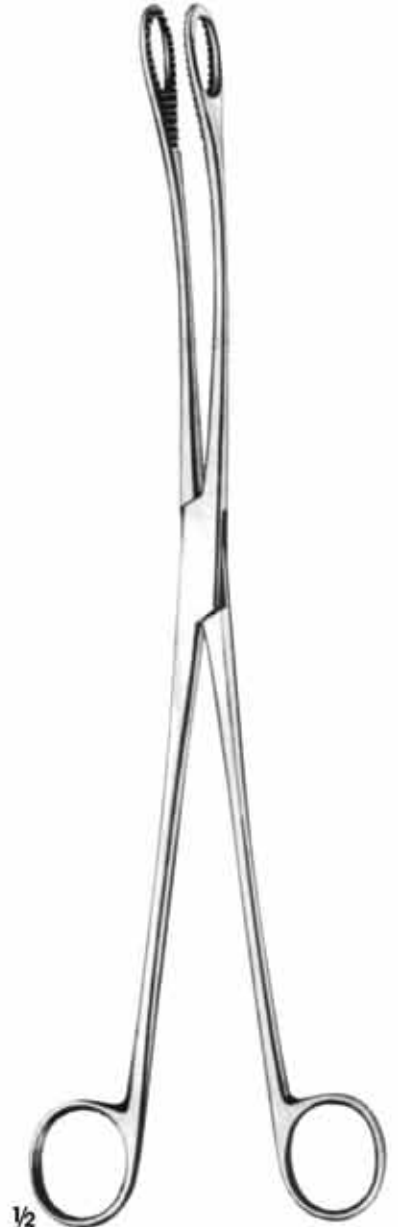

1/2

KELLY
EE122-00
32 cm

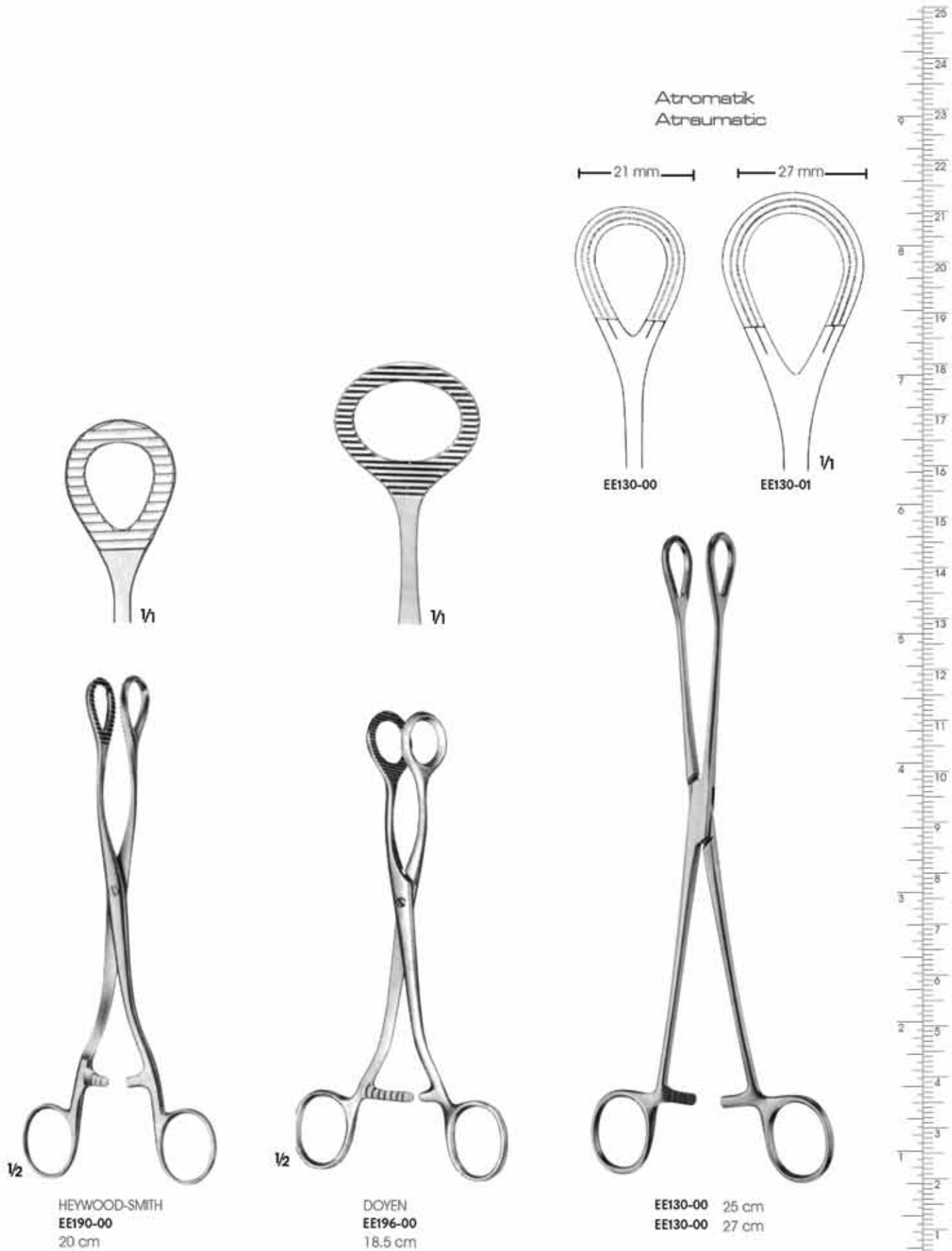



1/2

SOMER
EE560-01
23.5 cm



1/2

DARTIGUES
EE575-02
25.5 cm



1/2

COLLIN
EE550-01
26.5 cm

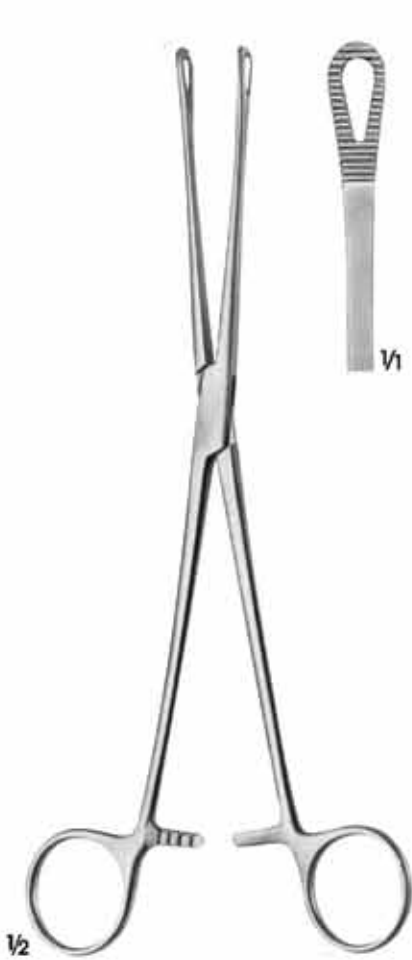

BONNEY
EE088-00
24 cm



COLLIN
EE570-01
25 cm



COLLIN
EE577-02
28.5 cm



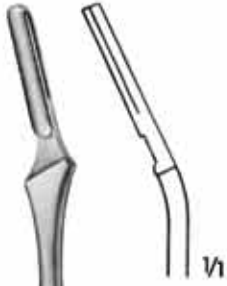

1/2

EB034-01
Açılı bistüri sapı
Scalpel handle, angular curved
22.5 cm



1/2

DOYEN
ET420-00
Miyoma burgusu
Myoma screw
15 cm



1/2

DOYEN
ET421-00
Miyoma burgusu
Myoma screw
19 cm



KEIBACK
EG675-00 23.5 cm
EG675-02 35 cm
Yan kavıslı üretral tünel penleri
Ureteral tunnel clamps, curved to side

UCHIDA
ET480-00 27 cm
ET480-03 35 cm
Kaşıklar/Spoons



KIEBACK
EC614-00-EC614-02
Parametrium makaslar
Parametrium scissors

KEIBACK
EC615-00-EC615-02
Parametrium makaslar
1 bleydi küre uclu, yana eğri
Parametrium scissors, curved to side,
with 1 probe pointed blade



BURKE
EG775-00-EG775-02
Parametrium pensler, kısa ağızlı
Parametrium clamps, short jaw part



BURKE
EG776-00-EG776-02
Parametrium pensler, uzun ağızlı
Parametrium clamps, long jaw part



Bükülebilir
Malleable

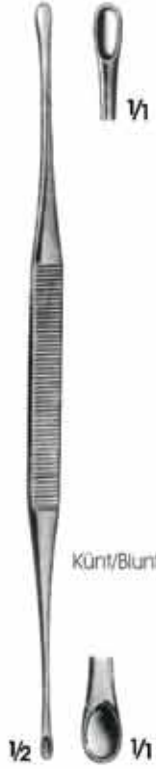

ASCH
EN585-01
Kaşık/Scoop
20 cm



RANDALL
EN580-02
Biyopsi küretli
Biopsy curette
24 cm



NOVAK-SCHOECKAERT
EN581-02
Biyopsi küretli
Biopsy curette
24 cm



BERLIN
EN595-04
Biyopsi küretli
Biopsy curette
27 cm



MÜNCHEN
EN595-05
Biyopsi küretli
Biopsy curette
27 cm

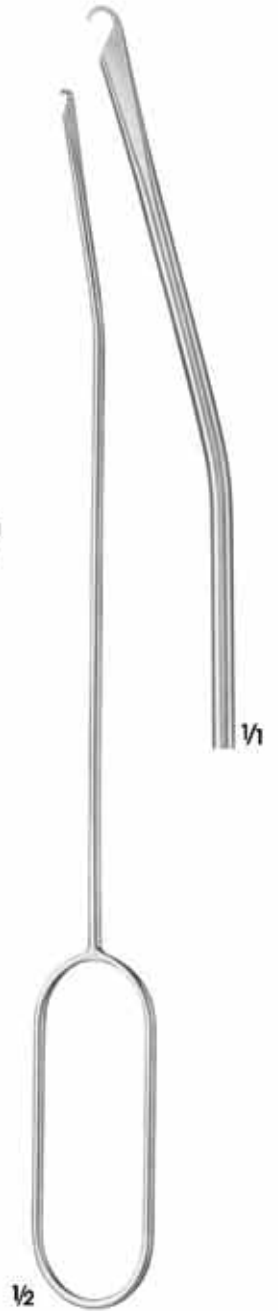

SAUNDERS
EN598-00
Çıkarma huk
Removing hook
32 cm



THOMS-GAYLOR
ER700-02
24 cm

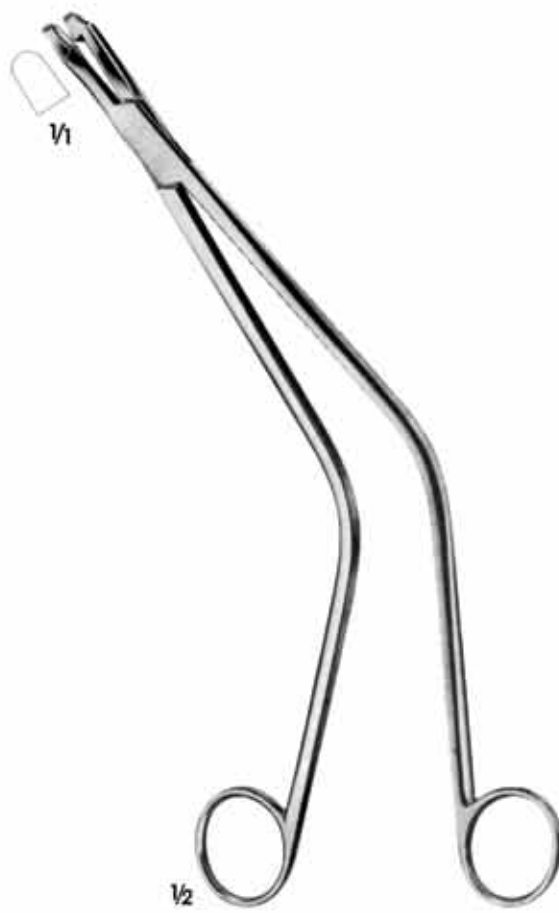

SCHUBERT
ER705-02
26 cm



FAURE
ER710-01
21 cm



FAURE
ER710-03
24 cm

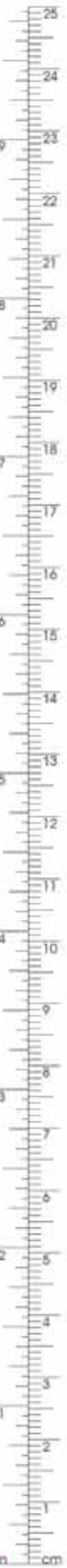

Çengel ağız ile daha güvenilir tutuş sağlar.
Ağız geniş açılabilir.
Düzgün ve uygun kesme sağlar.
Deforme olmamış ezilmemiş parça alınmasına imkan verir.
Travma'ya neden olmaması nedeni ile iyileşme çabuk olur.
More reliable grip on the tissue due to 'hooking' effect.
Wide angle of opening.
Smooth, steady cut.
Specimens are not squashed.
Not painful; self-wound, heals well.

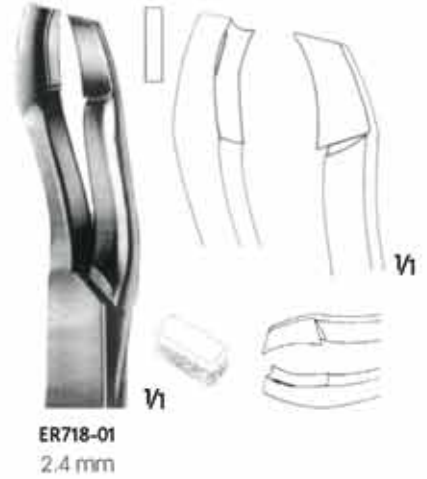
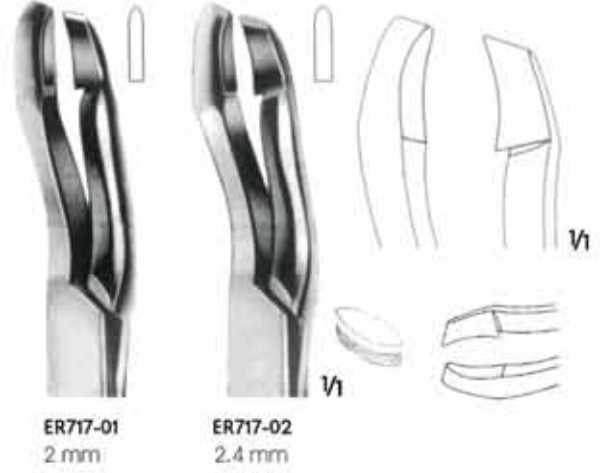
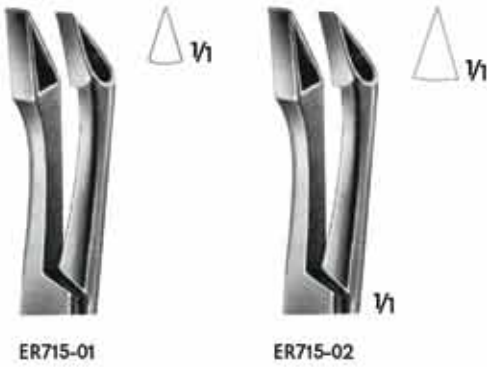

SCHUMACHER
ER715-01-ER715-02
24 cm



SEIDL DBP
ER717-01-ER718-02
Bayonet biyopsi pensleri
Bayonet-Shaped biopsy forceps
24 cm

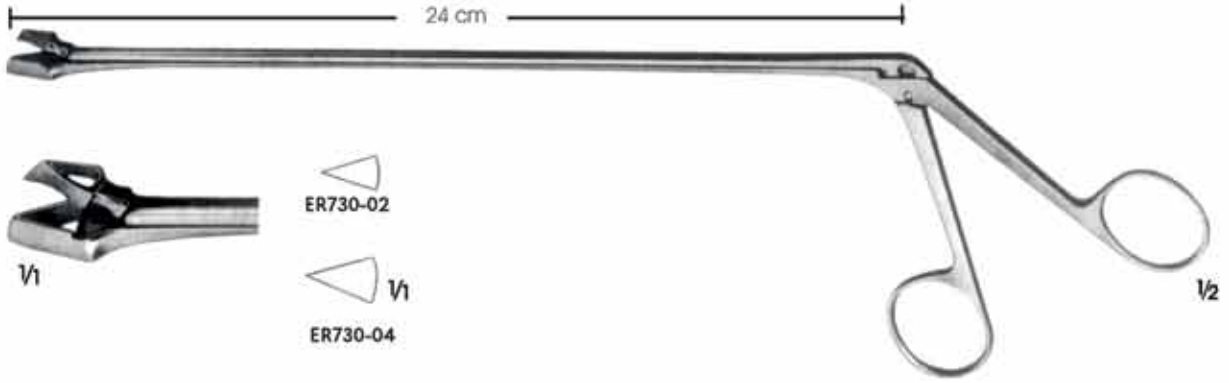

SCHUMACHER
ER730-02-ER730-04
Kolkoskopi için uygun
Suitable for colposcopy
24 cm



EPPENDORF
ER732-02
Kolkoskopi için uygun
Suitable for colposcopy
20 cm

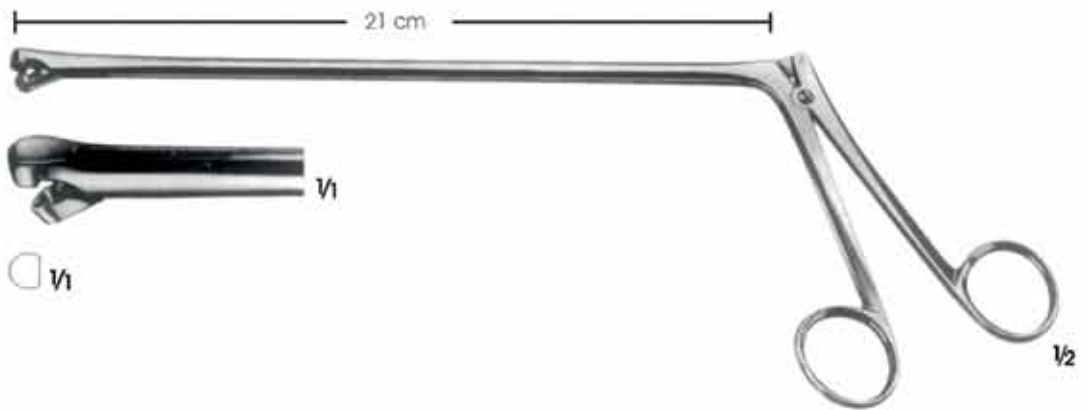

BERGER
ER734-02
21 cm

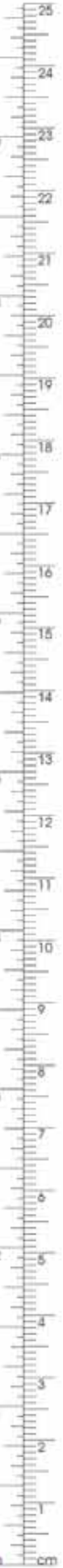

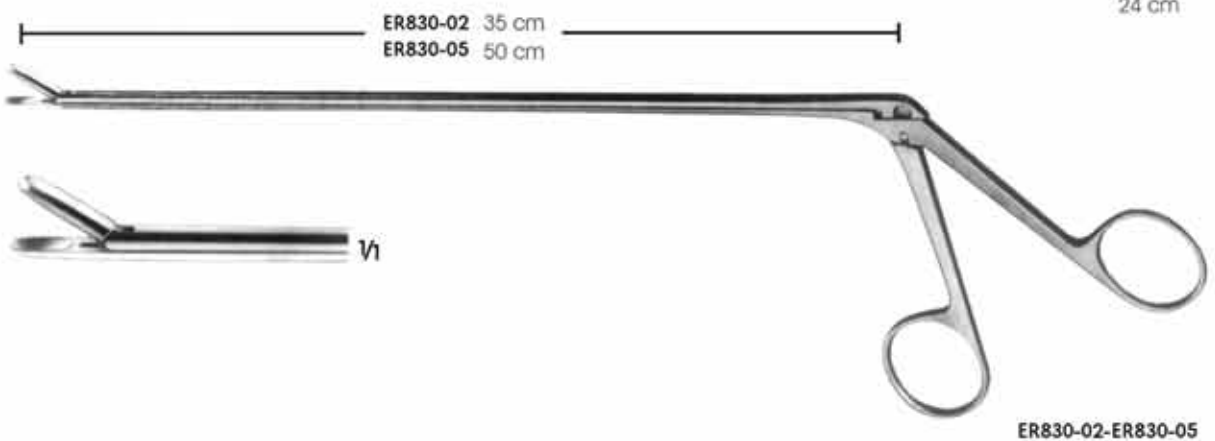
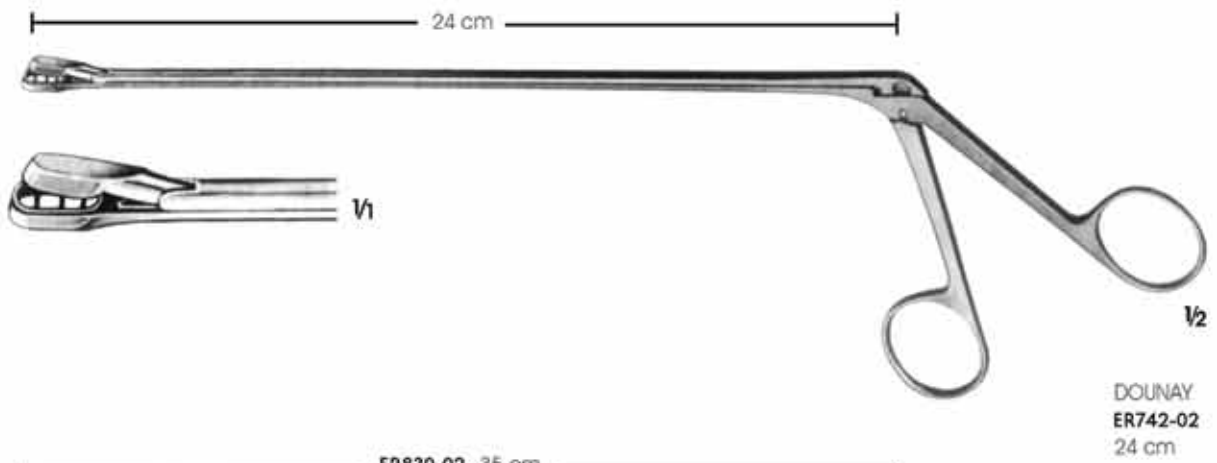
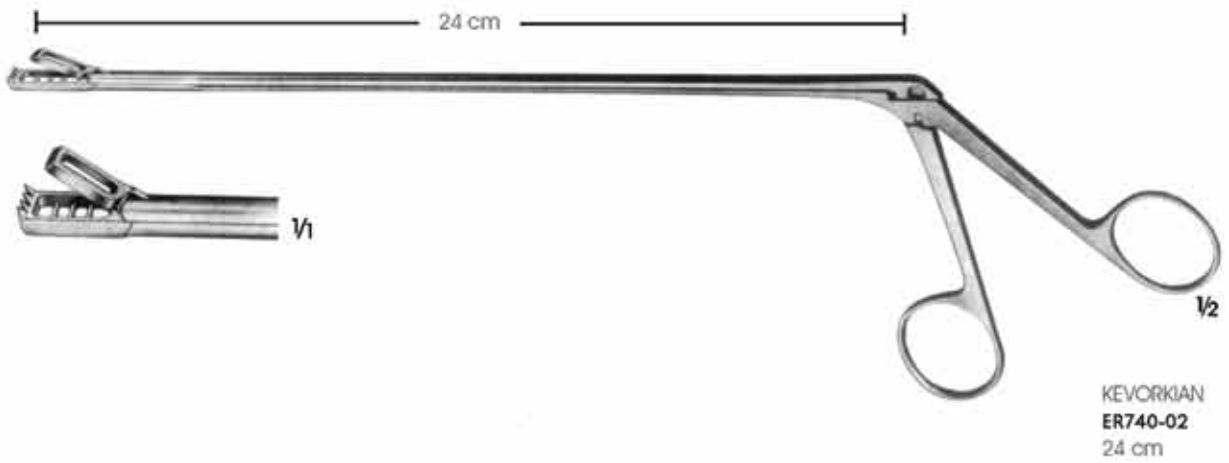
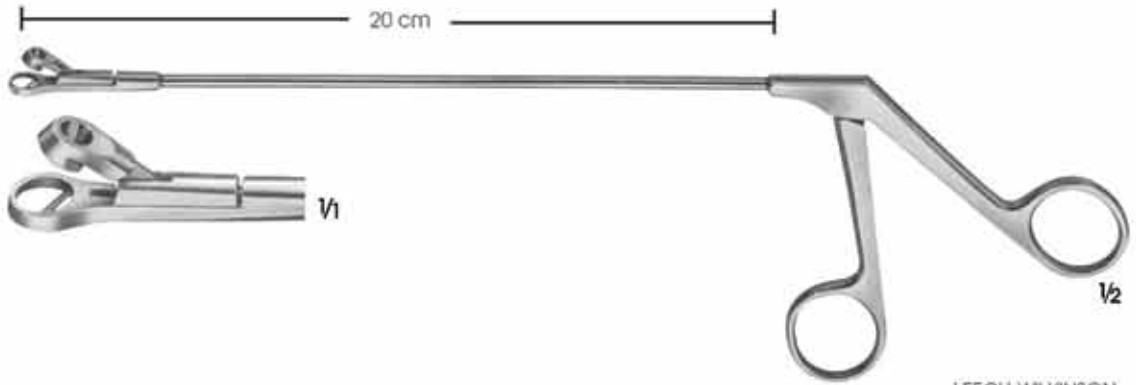

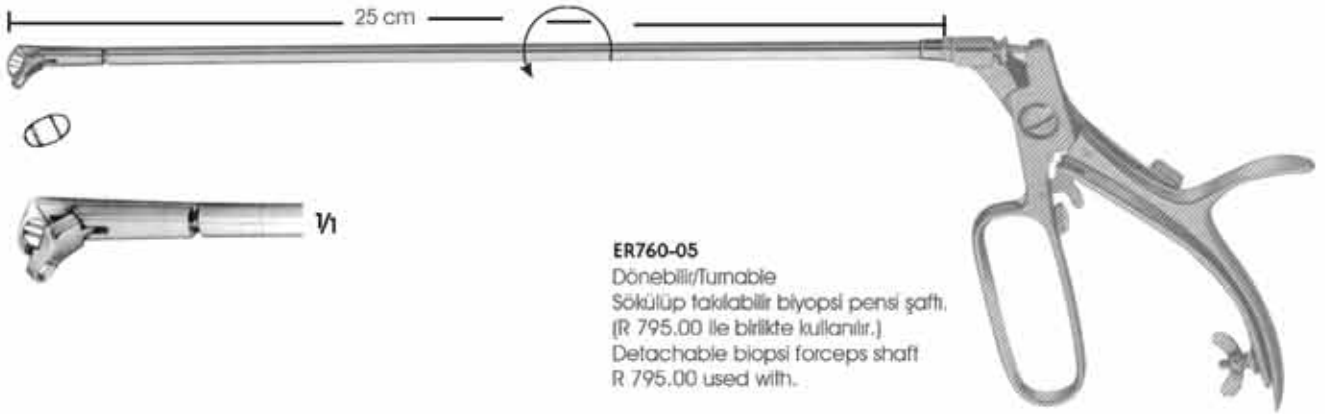
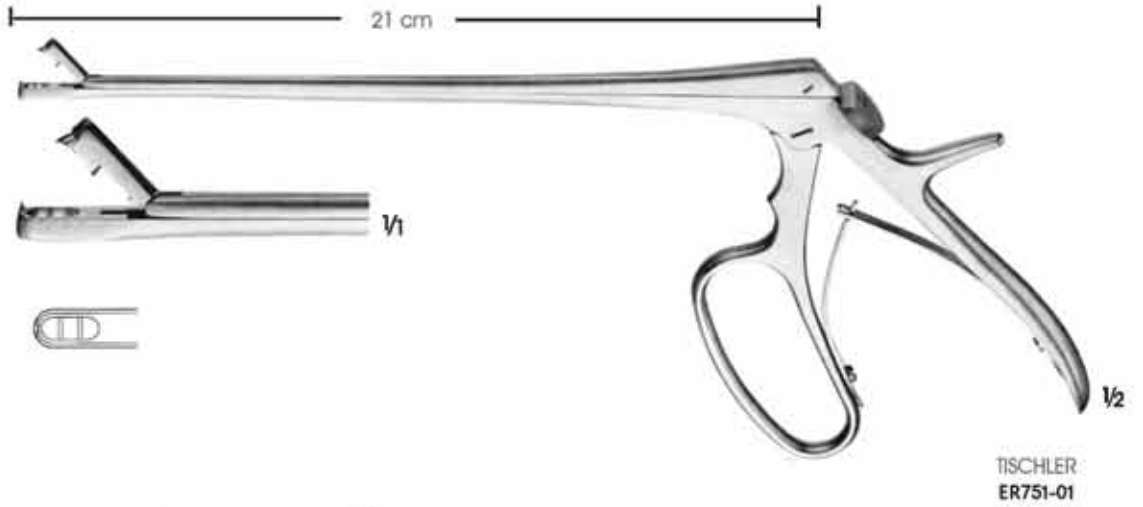

BRÜNNINGS
ER762-01 20 cm
ER762-02 25 cm
Uzatma kanülü/Extension cannula



KRAUSE
ER770-00-ER770-01
Biyopsi uçları/Biopsy tips



SCHUMACHER
ER774-00
Biyopsi ucu/Biopsy tip

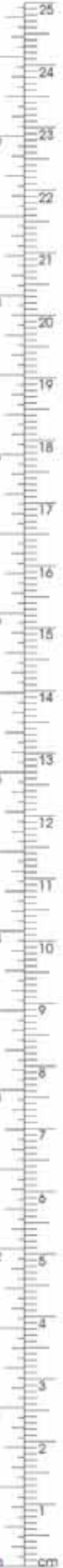

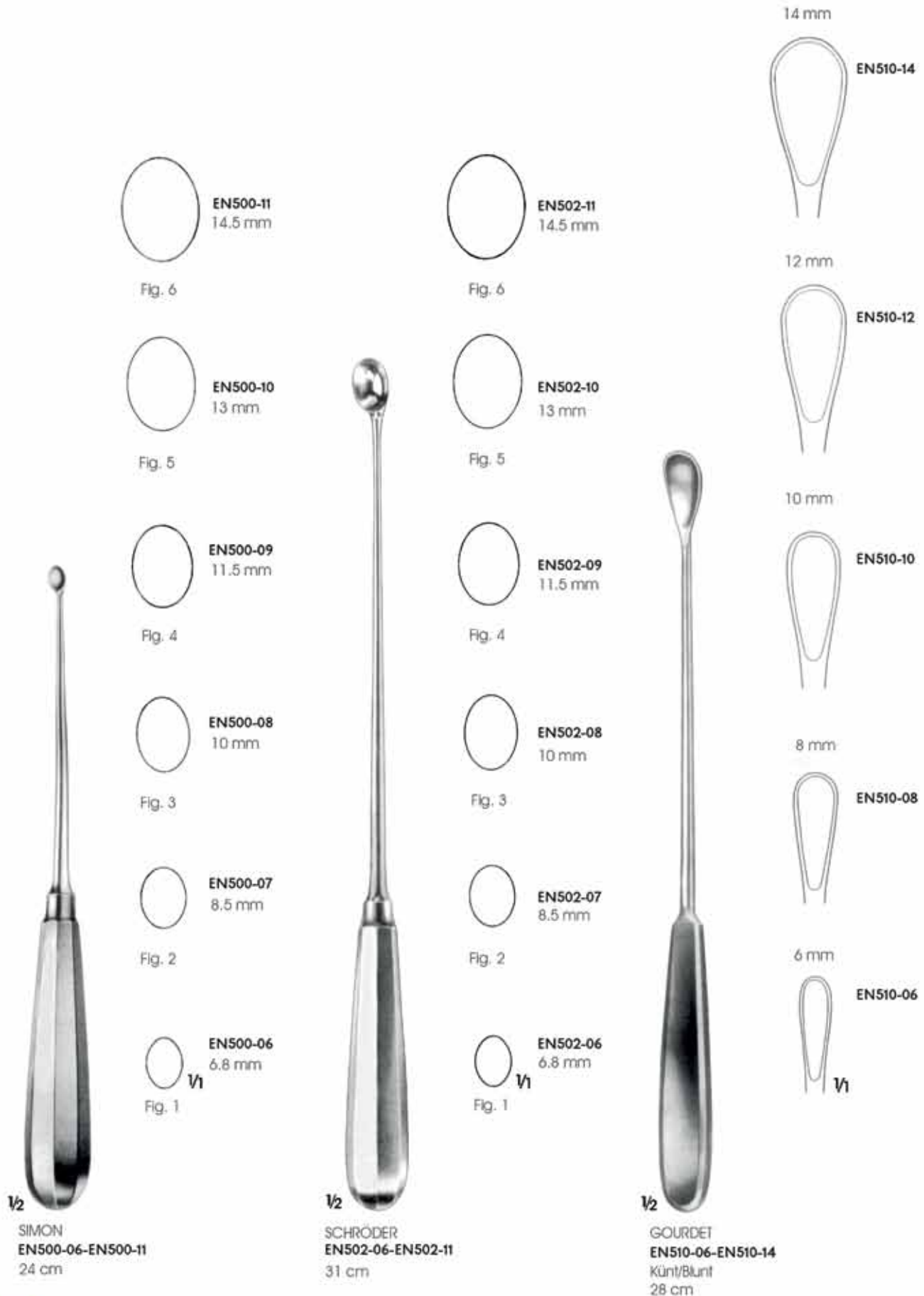



RECAMIER
EN520-04-EN520-38
 Sivri-Rijid/Sharp-Rigid
EN525-09-EN525-30
 Sivri-Bükülebilir/Sharp-Malleable
EN528-08-EN528-38
 Künt-Rijid/Blunt-Rigid
 30 cm



EN520-34
EN528-34
 21.5 mm



EN520-38
EN528-38
 23.5 mm



EN520-27
EN525-27
EN528-27
 18 mm



EN520-30
EN525-30
EN528-30
 19.5 mm



EN520-21
EN525-21
EN528-21
 15 mm



EN520-24
EN525-24
EN528-24
 16.5 mm



EN520-15
EN525-15
EN528-15
 12 mm



EN520-19
EN525-19
EN528-19
 14 mm



EN520-09
EN525-09
EN528-09
 8.5 mm





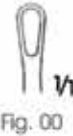











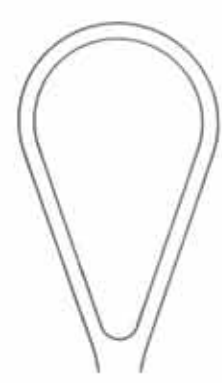

EN520-12
EN525-12
EN528-12
 10.5 mm



EN520-04
 4.5 mm

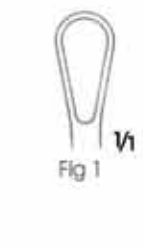

EN520-08
EN528-08
 7.5 mm

 <p>1/2</p>	 <p>Fig 6</p>	<p>EN530-21 EN532-21 EN534-21 15 mm</p>	 <p>1/2</p>	 <p>Fig 6</p>	<p>EN540-41 28.5 mm</p>		
	 <p>Fig 5</p>	<p>EN530-19 EN532-19 EN534-19 14 mm</p>		 <p>Fig 4</p>	<p>EN540-31 23.5 mm</p>	 <p>Fig 5</p>	<p>EN540-36 26 mm</p>
	 <p>Fig 4</p>	<p>EN530-15 EN532-15 EN534-15 12 mm</p>		 <p>Fig 4</p>	<p>EN540-23 19.5 mm</p>	 <p>Fig 3</p>	<p>EN540-27 21.5 mm</p>
	 <p>Fig 3</p>	<p>EN530-12 EN532-12 EN534-12 10.5 mm</p>		 <p>Fig 2</p>	<p>EN540-16 16 mm</p>	 <p>Fig 1</p>	<p>EN540-20 18 mm</p>
	 <p>Fig 2</p>	<p>EN530-09 EN532-09 EN534-09 8.5 mm</p>		 <p>Fig 0</p>	<p>Fig 1</p>	<p>Fig 1</p>	
	 <p>Fig 1</p>	<p>EN530-07 EN532-07 EN534-07 7.5 mm</p>					
	 <p>Fig 1</p>						

SIMS
EN530-07-EN530-21
 Sivri-Rijid/Sharp-Rigid
EN532-07-EN532-21
 Sivri-Bükülebilir/Sharp-Malleable
EN534-07-EN534-21
 Künt-Rijid/Blunt-Rigid
 25.5 cm

BUMM
EN540-16-EN540-41
 Künt-Bükülebilir/Blunt-Malleable
 29 cm



1/2

RECAMIER
EN550-34-EN550-44
Künt-Rijid/Blunt-Rigid
36 cm

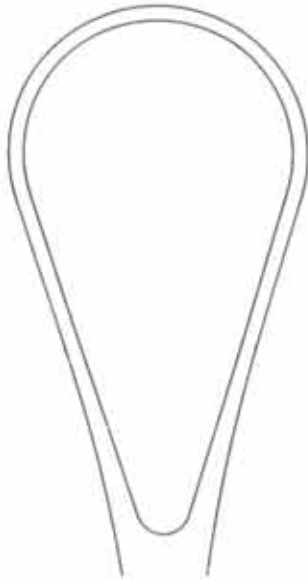

Fig. 2

EN550-44
39.5 mm

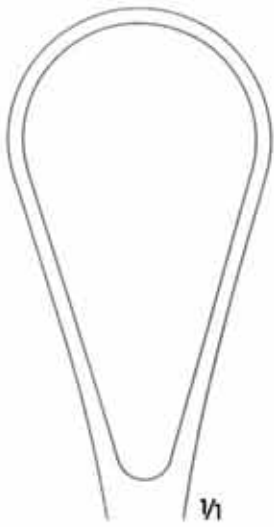

Fig. 1

EN550-34
34.5 mm

1/1



Fig. 3

EN552-35
EN554-35
28.5 mm



Fig. 2

EN554-30
26 mm



Fig. 1

EN552-24
EN554-24
23.5 mm



1/2

BUMM
EN552-24-EN552-35
Sivi-bükülebilir/Sharp-malleable
EN554-24-EN554-35
Künt-bükülebilir/Blunt-malleable
31 cm



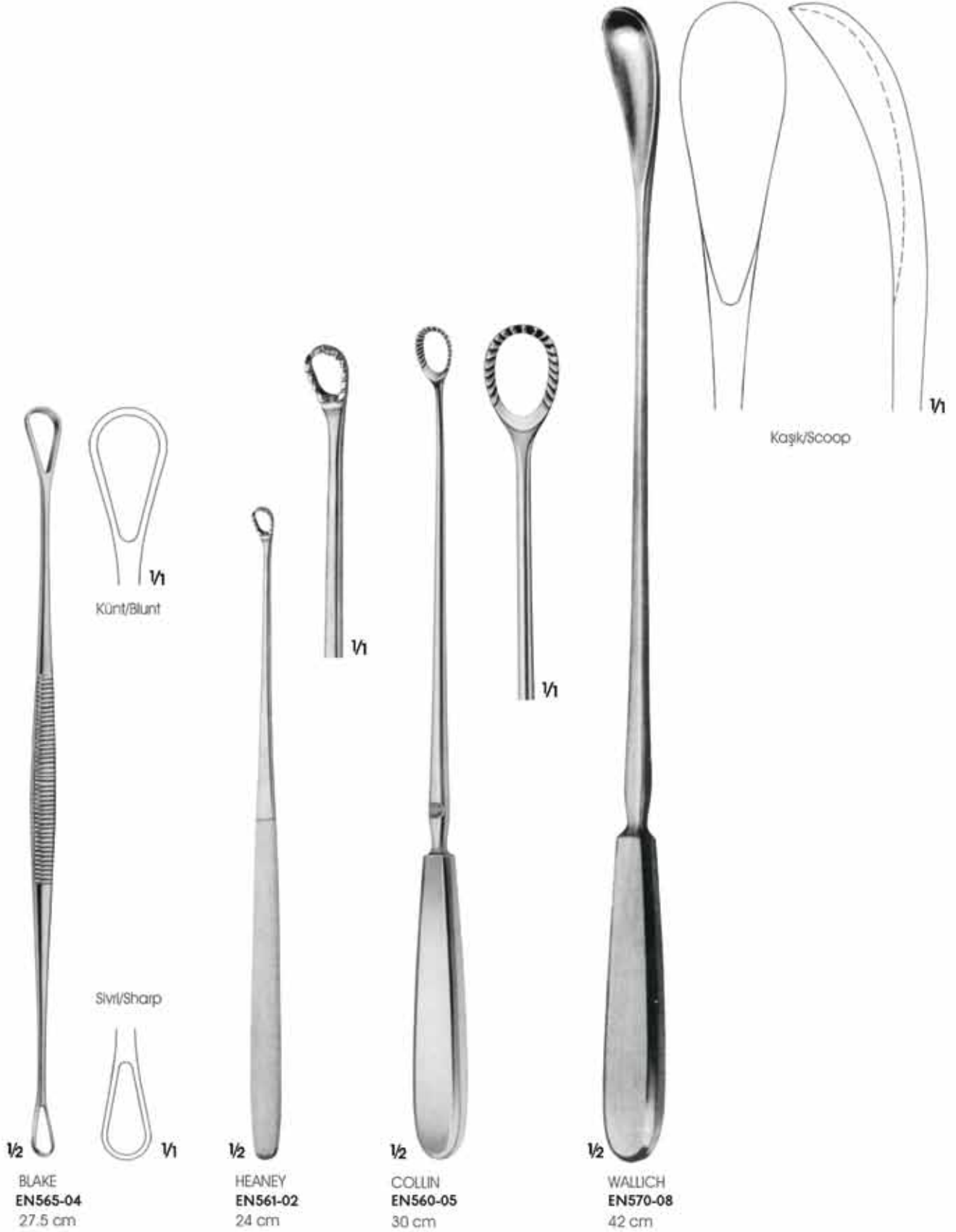



EJ451-00 Ø 4 mm
EJ451-01 Ø 6 mm
EJ451-02 Ø 8 mm
EJ451-03 Ø 10 mm
EJ451-04 Ø 12 mm
EJ451-05 Ø 14 mm



EJ459-00
Hortum bağlantısı, düz
Hose connection, straight
İç çap Ø 11 mm
inside diam Ø 11mm

EJ458-00
İç çap Ø 11 mm
inside diam Ø 11mm

Çalışması :

Arzu edilen (ihtiyaç duyulan) vakum miktar ayarlama vidası ile sürekli olarak istenilen değere ayarlanabilir. Vakum oluştuğunda bu vakumun emme kafalarına uygulanması için hızlı-kesme düğmesinin sağa veya sola basılması ile sağlanır. Ayarlanan vakum değeri vakum ayar vidası ile değiştirilebilir. Emme işleminin aniden durdurulması isteniyorsa hızlı-kesme düğmesi kapatılır. Böylece emme kafasına gelen vakum kesilmiş ve emme kavanozuna akış durdurulmuş olur.

Function:

The vacuum required can be constantly preset by the adjusting screw. This vacuum exists then up to the closed quick-shutter, thus the vacuum in the suction head is pressed from the left to the right, the rounded suction head is immediately put under the preset vacuum. In case the preset vacuum has to be changed, this can be done with the adjusting screw. For immediate removal of the suction head simply close the quick-shutter, thus the vacuum in the suction head is eliminated at once whereas the vacuum in the suction jar remains unchanged.



EJ480-03 40 mm
EJ480-04 50 mm
EJ480-05 60 mm
Çekme kolu ile birlikte
With traction handle
134°C Otoklav edilebilir
134°C Autoclavable

EN480-10
El vanası ve bağlantı borusu
20 cm uzunluğunda bağlantı borusu
Hand valve with connection hose
20 cm long connection hose





SCHULZE
EJ490-04
Uç/Tip

SCHULZE
EJ490-03
Uç/Tip

EJ490-02
Uç/Tip



SCHULZE
EJ490-01
37.5 cm

1/2

SCHULZE
EJ490-00 Komple/Complete
J 490.01
J 490.02-J 490.03-J 490.04
Salpingografi için uterin kanül
Salpingography uterine cannula



1/1

EJ496-02
Büyük/Large
Ø 16 x 30 mm



1/1

EJ496-01
Orta/Medium
Ø 13 x 30 mm



1/1

EJ496-00
Küçük/Small
Ø 10 x 25 mm

1/2

LEECH-WILKINSON
EJ496-00-EJ496-02
Uterin kanül
Uterine cannula
26.5 cm



1/2

EJ952-00
Rahim kanülü, büyük ve küçük
2 adet değiştirilebilir konik uçları ile
Uterine cannula with spring
connector, self-retaining complete with
2 interchangeable cones large and small
25 cm



**SPACKMAN
EJ493-00**
Ayarlanabilir plaka ile
vulsüm pensi
With adjustable plate for
vulsüm forceps
36 cm



**BEHRMAN
EJ495-00**
Konik ucu çıkartılabilir
uterin kanülü
Uterine cannula with
detachable cone
30.5 cm

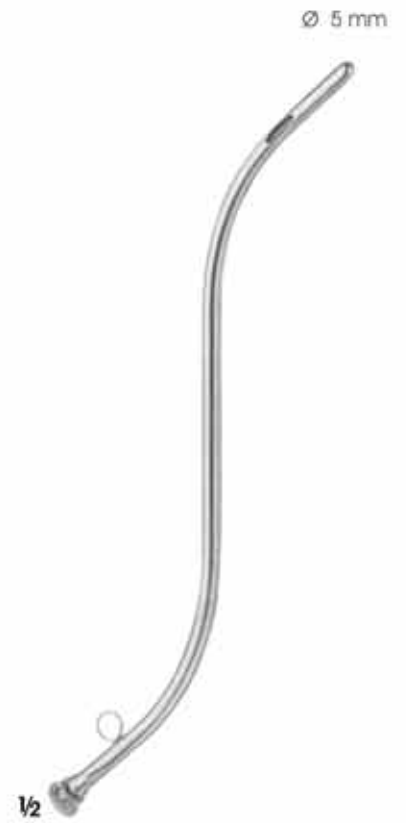

**ROTUNDA
EJ497-00**
İrigasyon kanülü
Irrigation cannula
20 cm



Özel Set transvajinal paraservikal ve
pupendus anestezli Enjeksiyonu için
Special set for transvaginal injection for
paracervical anesthesia as well as
anesthesia of the pudendus



EJ133-00
Kılavuz kılıfı
Guide sheath
17.5 cm

EJ134-00
Enjeksiyon iğnesi
Injection needle
Luer-lock
1,0 x 18,5 cm



DE LEE
EA610-01
Pelvimetre santimetre ve inç ölçülü
Pelvimeter centimeters and inches
measured



MARTIN
EA620-01
Santimetre ölçülü
Graduated in centimeters



**BEACHAM
EK295-02**
Amniyotom/Amniotome
24 cm



EB610-01
Poş Açıcı/Pouch opener
44 cm



**HERFF
EB387-02**
Zar delici pens
Membrane puncturing forceps
25.5 cm



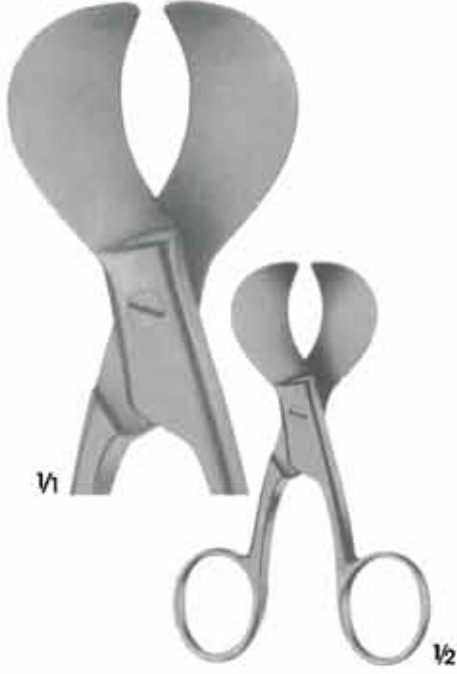

EC600-00
Göbek bağı makası
Umbilical cord scissors
10.5 cm



SCHUMACHER
EC602-00
Göbek bağı makası
Umbilical cord scissor
15.5 cm

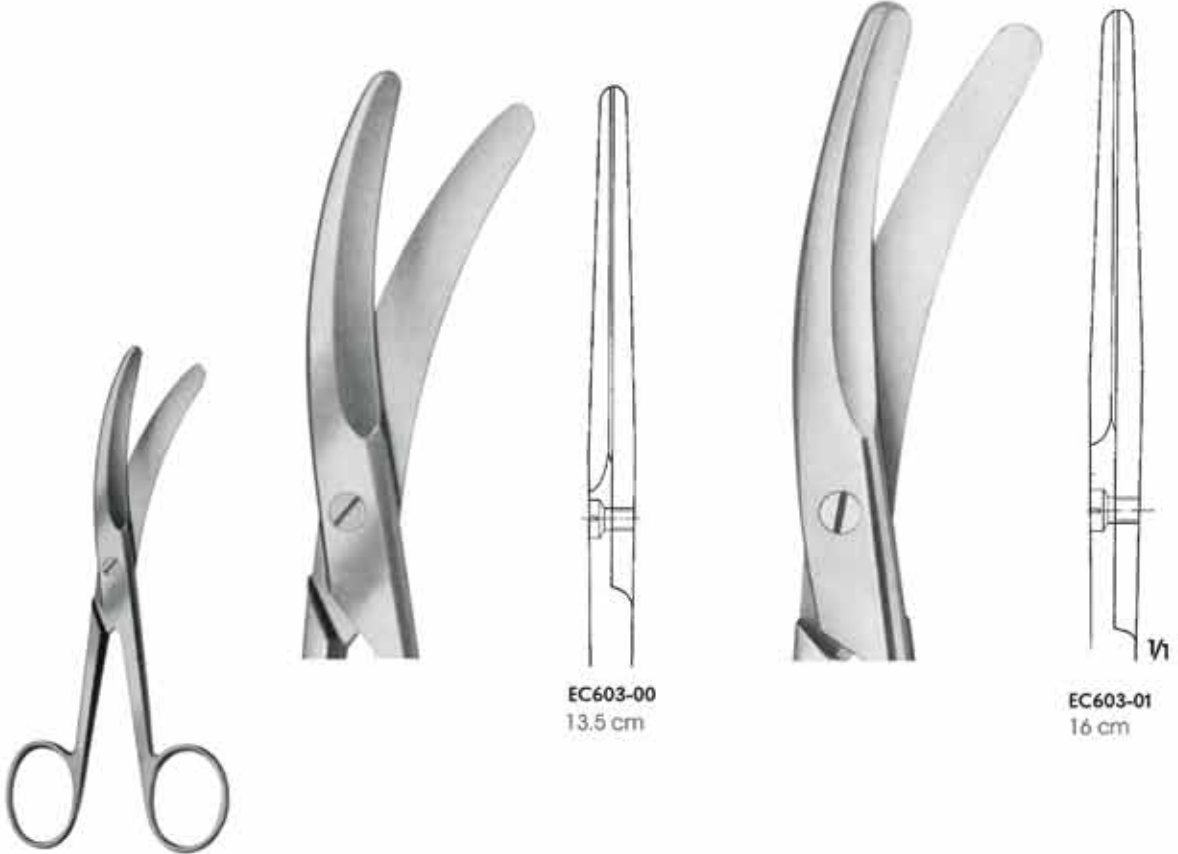

EC603-00-EC603-01
Göbek bağı makaları
Umbilical cord scissors

EC603-00
13.5 cm

EC603-01
16 cm



BRAUN-STADLER
EC604-00-EC604-01
Epizyotomi makasları
Episiotomy scissors



EC604-00
14.5 cm



EC604-01
20 cm



EC610-00
Epizyotomi makas
Episiotomy scissors
24 cm

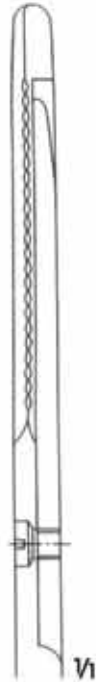

1/2

EJ085-00
Göbek dilatörü
Umbilical dilator
9.5 cm



1/2

COLLIN
ET425-00
Göbek kordonu klampı
Umbilical cord clamp
8.5 cm





1/3

**SIMPSON
EE558-02**
Sezeryan ameliyatı için
For caesarean section
23.5 cm



1/3

**SIMPSON-BRAUN
EE555-00**
30.5 cm



1/3

**SIMPSON-BRAUN
EE556-00**
35 cm



1/3

**NAGELE
EE557-02**
35.5 cm



1/3

WRIGLEY
EE559-02
Sezeryan ameliyatı için
For caesarean section
25 cm



1/3

SELHEIM
EE573-02
Obstetrik levye
Obstetric lever
30 cm



1/3

KELLAND
EE565-02
42 cm



1/3

PIPER
EE567-02
44.5 cm





TARNIER
EE578-04
Çekme çubuklu
With traction rod
40 cm



BARNES-NEVILLE
EE579-04
Çekme sapları
With traction handle
43.5 cm

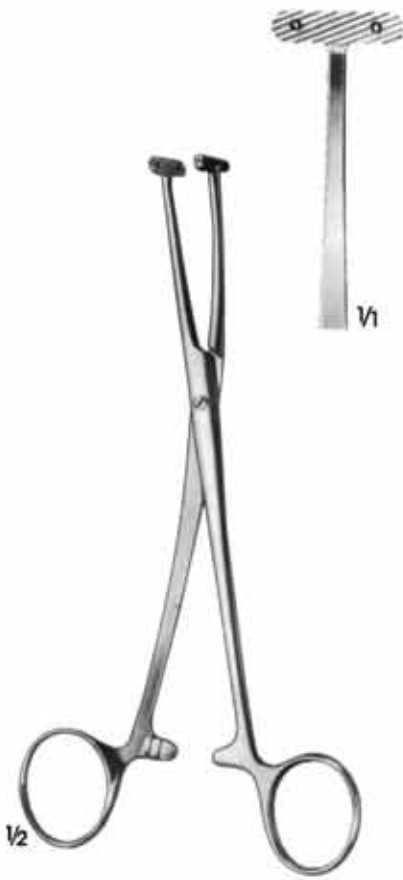

**WILLETT
EE590-01**
Kafa derisi tutucu pens
Scalp flap forceps
18.5 cm

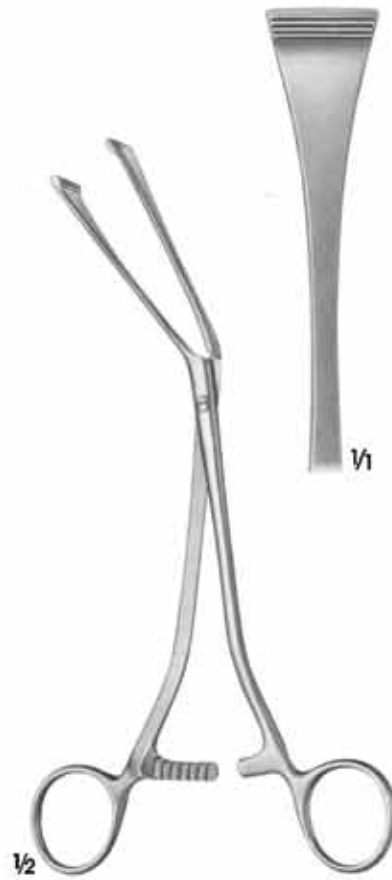

**GREEN-ARMYTAGE
EE593-01**
Sezeryan hemostatik pens, açılı
Caesarean hemostatic forceps,
angled
19.5 cm



**GREEN-ARMYTAGE
EE594-02**
Sezeryan hemostatik pens düz
Caesarean hemostatic forceps,
straight
22 cm

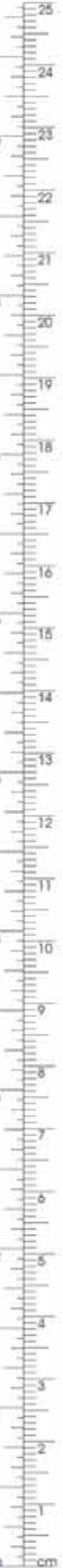



EE700-01 EE700-02 $\frac{1}{1}$



EE702-01 EE702-02 EE702-03 $\frac{1}{1}$



EE705-01 EE705-02 $\frac{1}{1}$



$\frac{1}{2}$
WINTER
EE700-01-EE700-02
29 cm



$\frac{1}{2}$
WINTER
EE702-01-EE702-03
29 cm



$\frac{1}{2}$
WINTER
EE705-01-EE705-02
Kilitli/With ratchet
29 cm

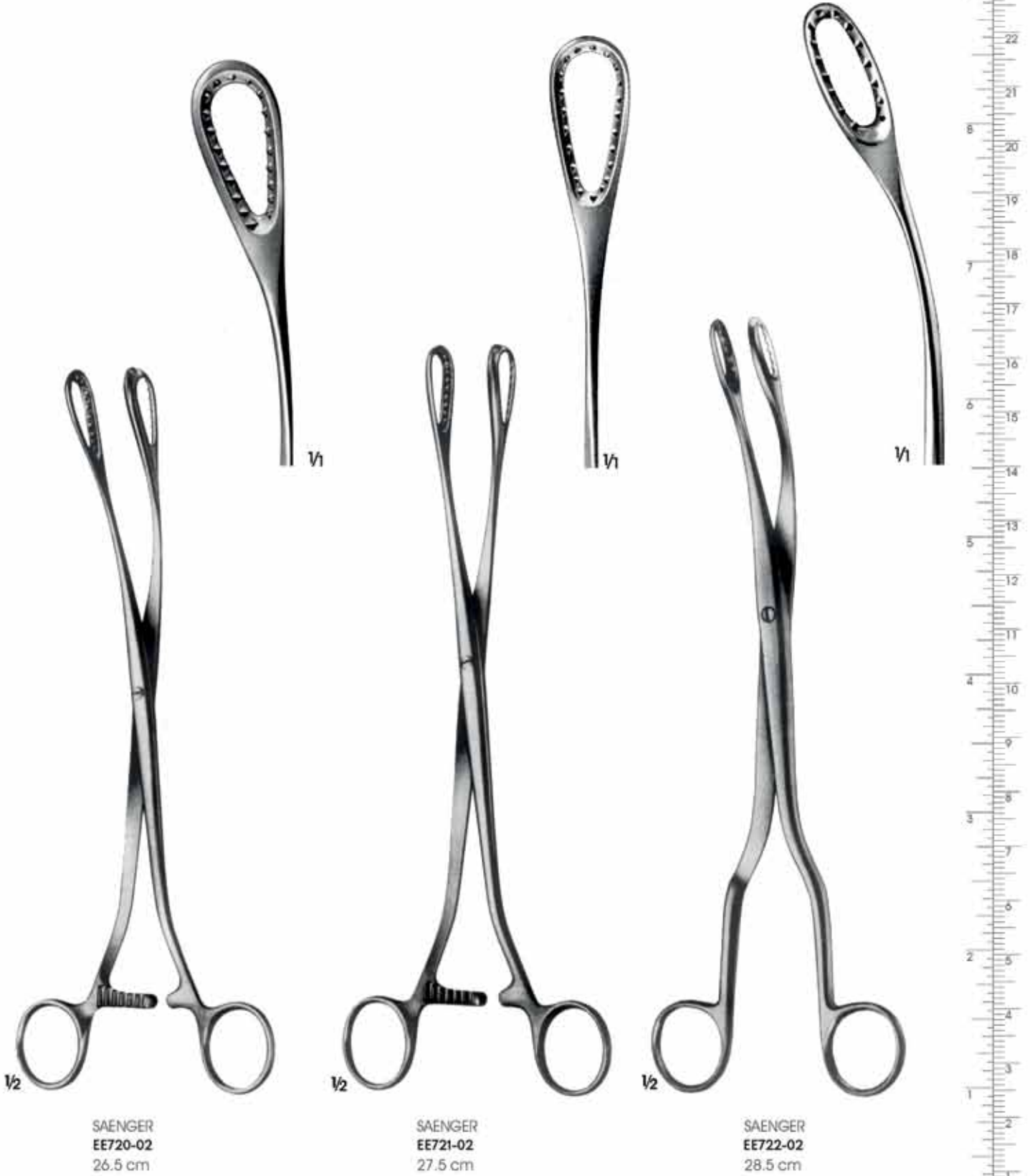





SMELLIE
ET430-01
27 cm



LEWKOWITZ
EE730-02-EE731-02
24.5 cm



BOER
EE735-02
29 cm

EKR

Kalp ve Damar Cerrahi
Cardiovascular and Thoracic Surgery



Küçük(sarı)
Small(yellow)



Orta(mavi)
Medium(blue)



Orta-büyük(yeşil)
Medium-large(green)



Büyük(turuncu)
Large(orange)



Küçük(sarı)
Small(Yellow)



EG070-03 25°
28 cm



EG071-03 65°
28 cm

Orta(mavi)
Medium(blue)



EG072-03 25°
28 cm



EG073-03 65°
28 cm

Orta-büyük(yeşil)
Medium-large(green)



EG074-03 25°
28 cm



EG075-05 65°
28 cm



EG076-03 90°
28 cm

Büyük(turuncu)
Large(orange)



EG077-03 25°
28 cm



EG078-05 65°
28 cm



EG079-03 90°
28 cm

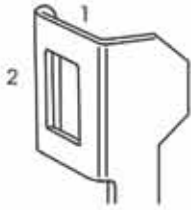

	Göğüs ekartörü bleydleri için ölçü sistemi Derinlik : 1 Genişlik : 2 Örnek: 1 x 2	Measurement system for rib retractor blades Depth : 1 Width : 2 Example: 1 x 2
---	---	--



STRUCK
EL800-00 Komple/Complete
EL800-02 Sadece Ekartör/Retractor Only
EL800-05-EL800-09 Bleydler(çift)/Blades(pairs)

Bleyd(çift)/Blade(pair)

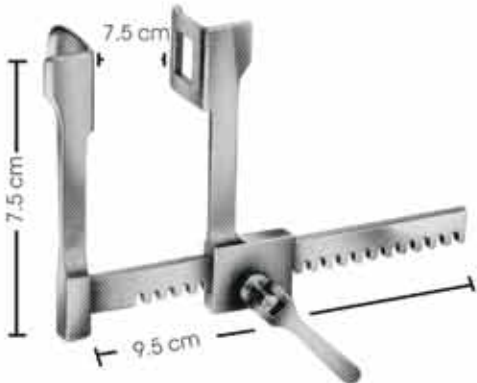

FINOCHIETTO
EL802-00
Bleydler/Blades
18 x 21 mm

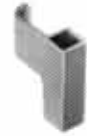

STRUCK
EL800-05
Bleydler/Blades
10 x 10 mm



STRUCK
EL800-06
Bleydler/Blades
10 x 15 mm



STRUCK
EL800-07
Bleydler/Blades
10 x 20 mm



STRUCK
EL800-08
Bleydler/Blades
15 x 20 mm



STRUCK
EL800-09
Bleydler/Blades
20 x 20 mm

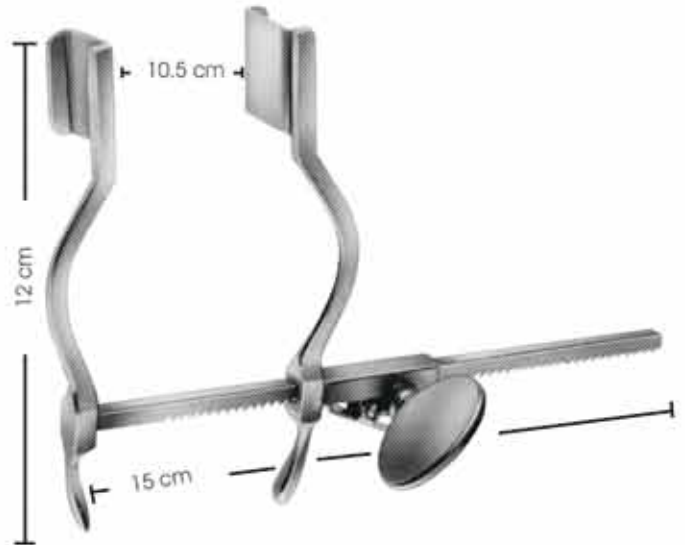

HERTZLER
EL522-00
Bleydler/Blades
20 x 25 mm

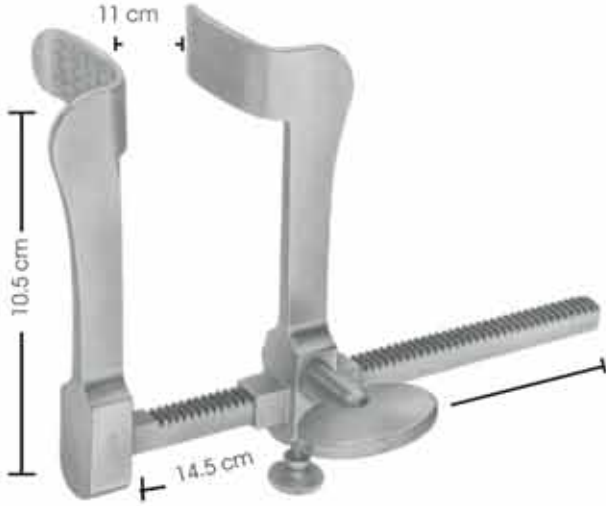

TUFFIER
EL803-00
Bebekler için göğüs ekartörü
Rib retractor for infants
Bleydler/Blades
32 x 19 mm



TUFFIER
EL804-00
Göğüs ekartörü/Rib Retractor
Bleydler/Blades
43 x 53 mm

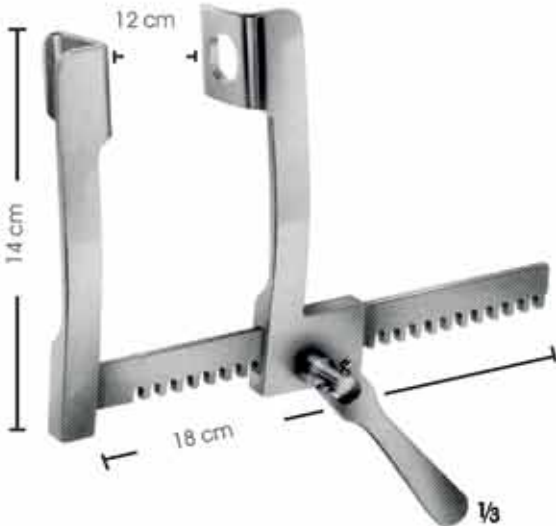

FINOCHIETTO
EL807-00
Göğüs ekartörü/Rib retractor
Bleydler/Blades
28 x 32 mm

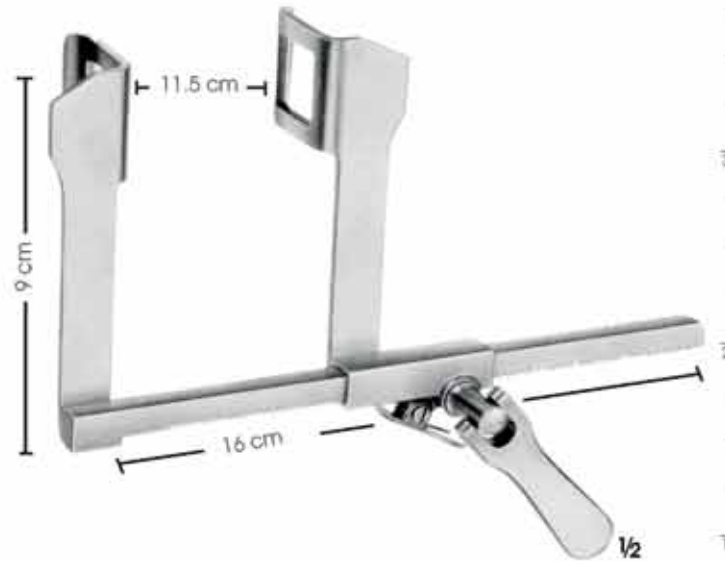

HAIGHT
EL806-00
Göğüs ekartörü/Rib retractor
Bleydler/Blades
30 x 30 mm



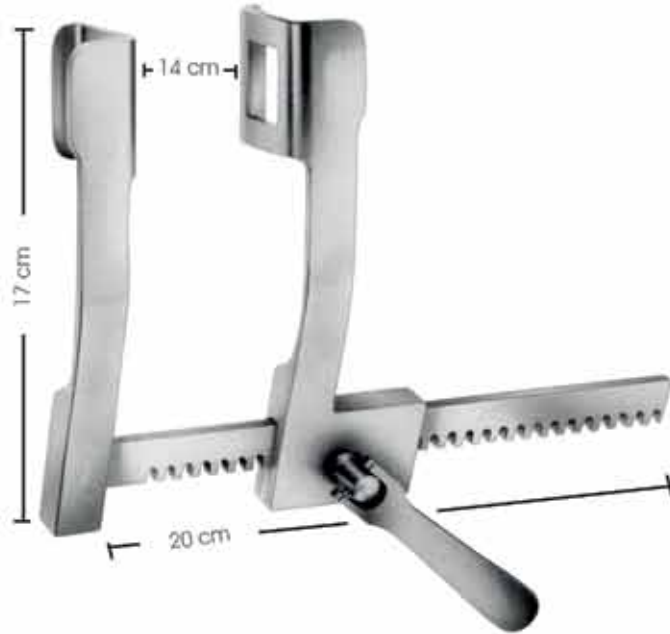

FINOCHIETTO
EL808-00
Bleydler/Blades
36 x 45 mm

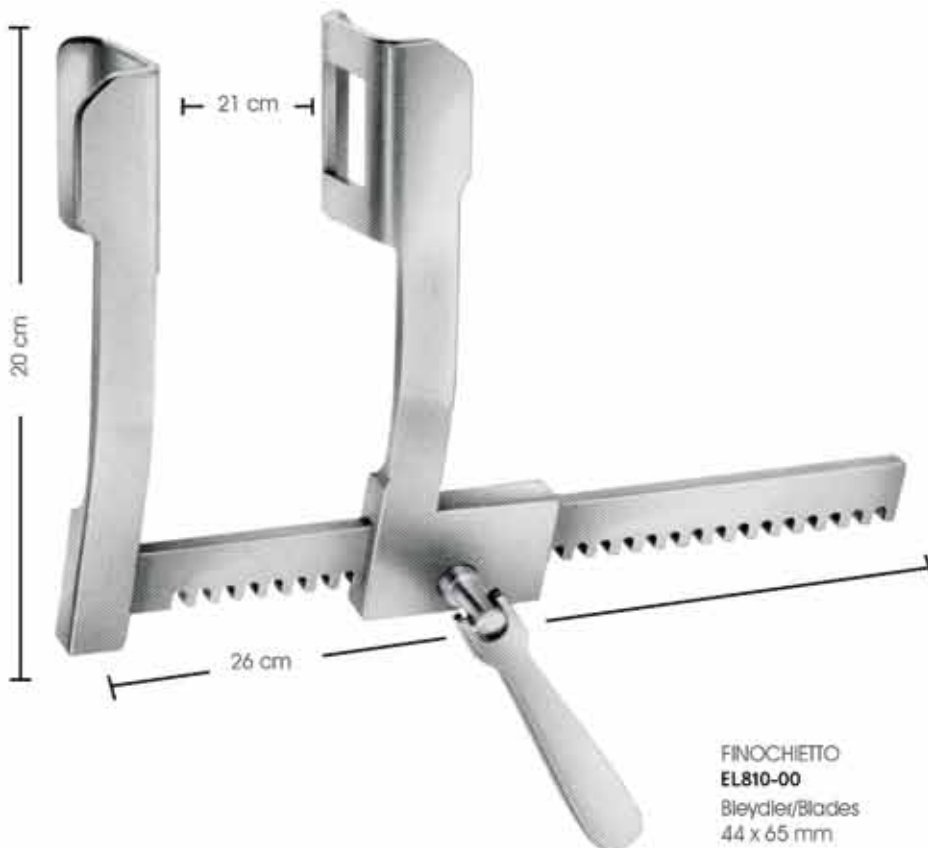

FINOCHIETTO
EL810-00
Bleydler/Blades
44 x 65 mm

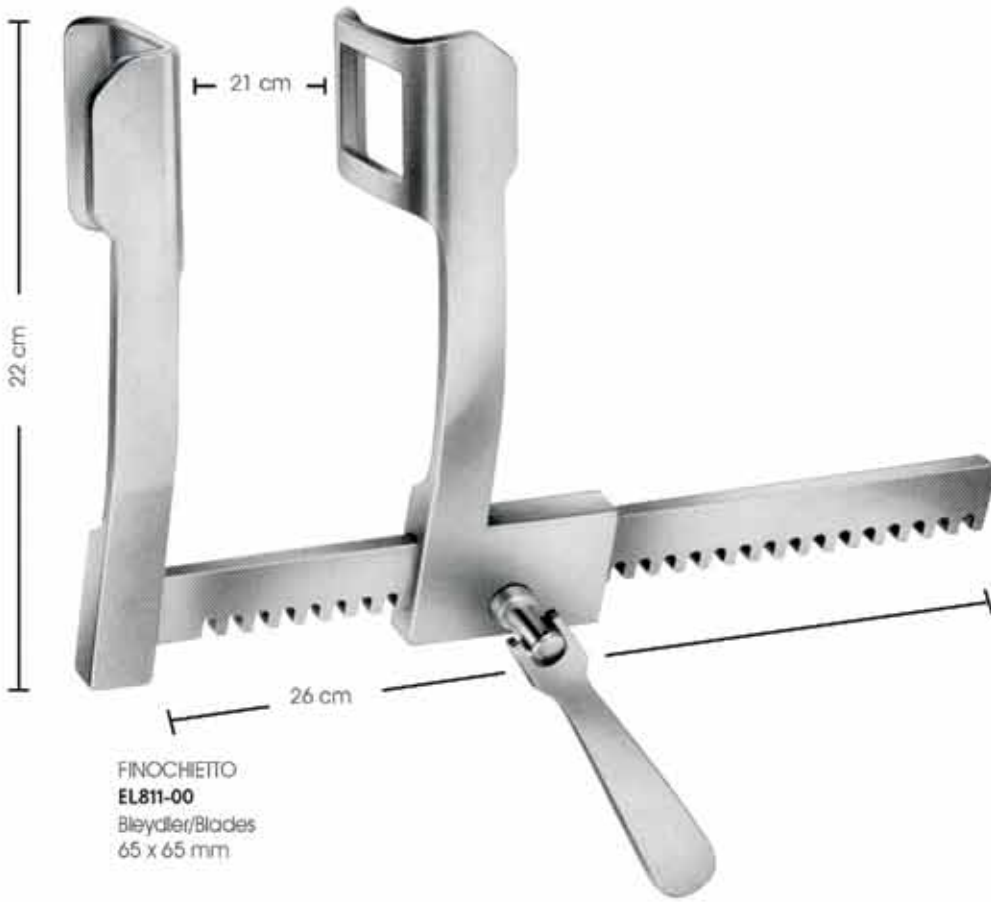

FINOCHIETTO
EL811-00
Bleydler/Blades
65 x 65 mm

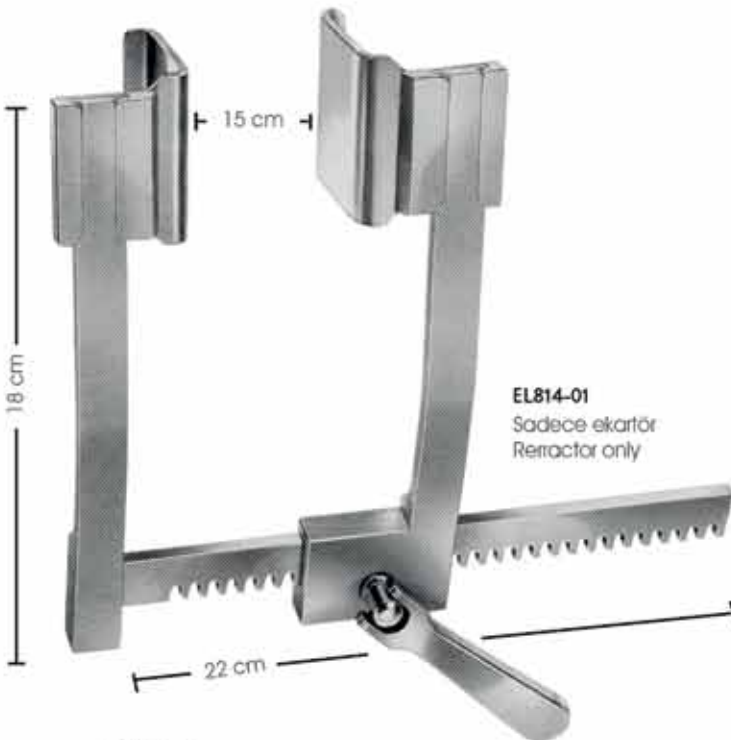

DE BAKEY
EL814-00 D0 Komple/Complete
EL814-01 1 Sadece ekartör/Retractor only
EL814-05-EL814-06-EL814-07 Bleydler(çift)/Blades(pair)

DE BAKEY
EL814-05
Bleydler/Blades
30 x 30 mm



DE BAKEY
EL814-06
Bleydler/Blades
40 x 40 mm



DE BAKEY
EL814-07
Bleydler/Blades
50 x 50 mm





FINOCHIETTO-BURFORD
EL812-10
Bleydler/Blades
75 x 64 mm



FINOCHIETTO-BURFORD
EL812-05
Bleydler/Blades
45 x 64 mm

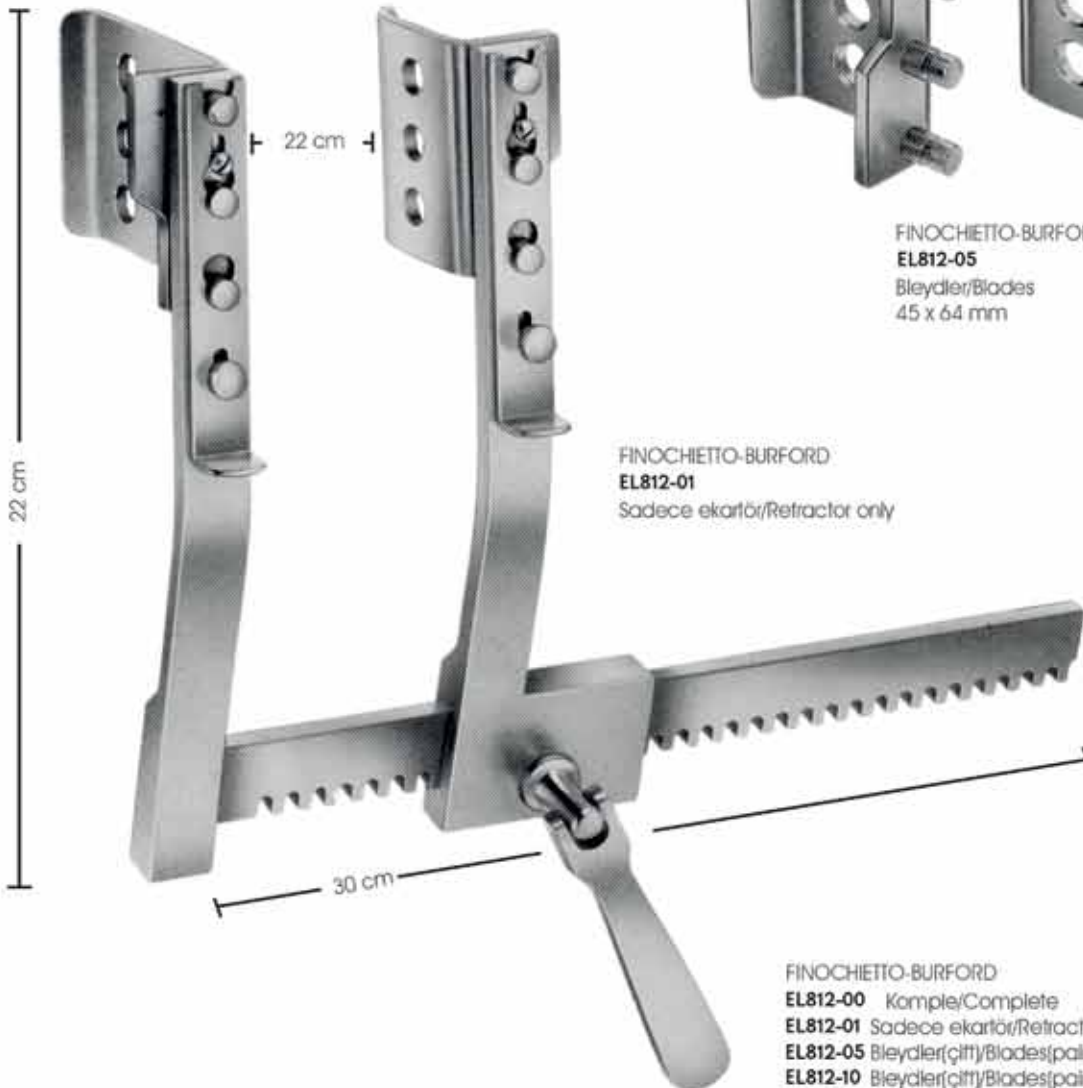

FINOCHIETTO-BURFORD
EL812-01
Sadece ekartör/Retractor only

FINOCHIETTO-BURFORD
EL812-00 Komple/Complete
EL812-01 Sadece ekartör/Retractor only
EL812-05 Bleydler(çift)/Blades(pairs)
EL812-10 Bleydler(çift)/Blades(pairs)

Özel Avantajlar:
Değiştirilebilir bıyklar için geliştirilmiş sabitleme sistemi
Avantaj Special Advantages :
Improved fixing system for interchangeable blades

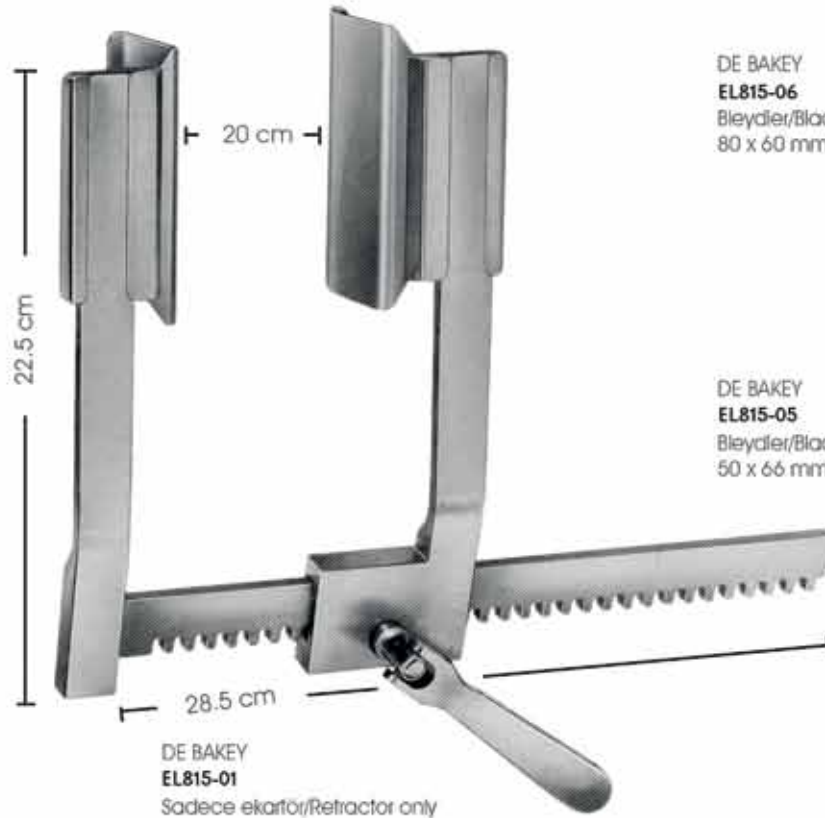

DE BAKEY
EL815-09
Bıyklar/Blades
60 x 60 mm



DE BAKEY
EL815-08
Bıyklar/Blades
50 x 80 mm



DE BAKEY
EL815-07
Bıyklar/Blades
40 x 100 mm



DE BAKEY
EL815-06
Bıyklar/Blades
80 x 60 mm



DE BAKEY
EL815-05
Bıyklar/Blades
50 x 66 mm



DE BAKEY
EL815-00 Komple/Complete
EL815-01 Sadece ekartör/Retractor only
EL815-07 Bıyklar(çift)/Blades(pair)
EL815-08 Bıyklar(çift)/Blades(pair)
EL815-09 Bıyklar(çift)/Blades(pair)

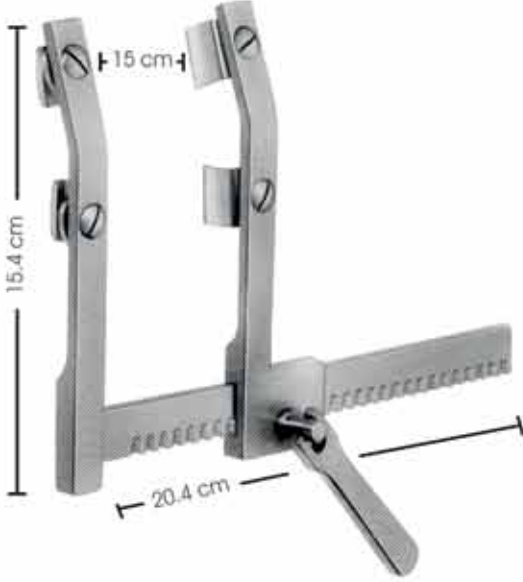

MORSE
EL820-00

Sternum ayırıcı/Sternum spreaders
Çocuklar için, hareket ettirilebilir çift bleydli
For children with movable double blades
Bleyd/Blade 12 x 20 mm

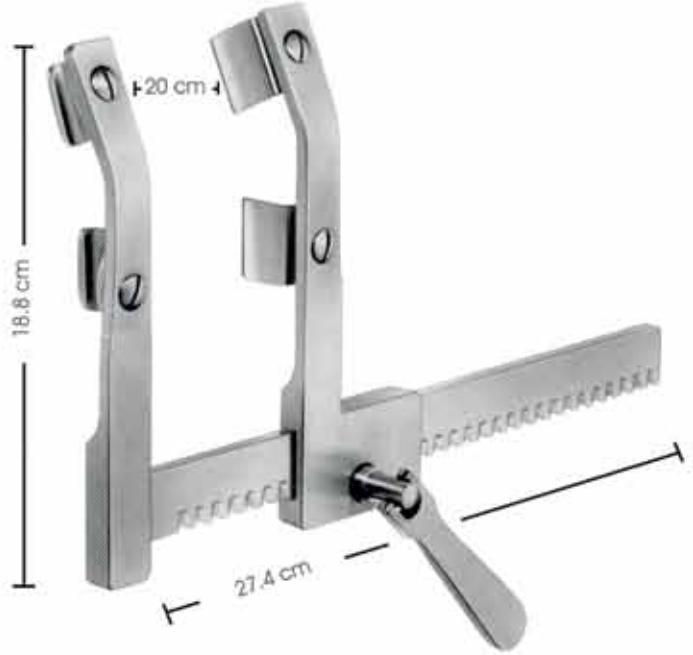

MORSE
EL820-01

Sternum ayırıcı/Sternum spreaders
Büyükler için, hareket ettirilebilir çift bleydler
For adults with movable double blades
Bleyd/Blade 19 x 29 mm

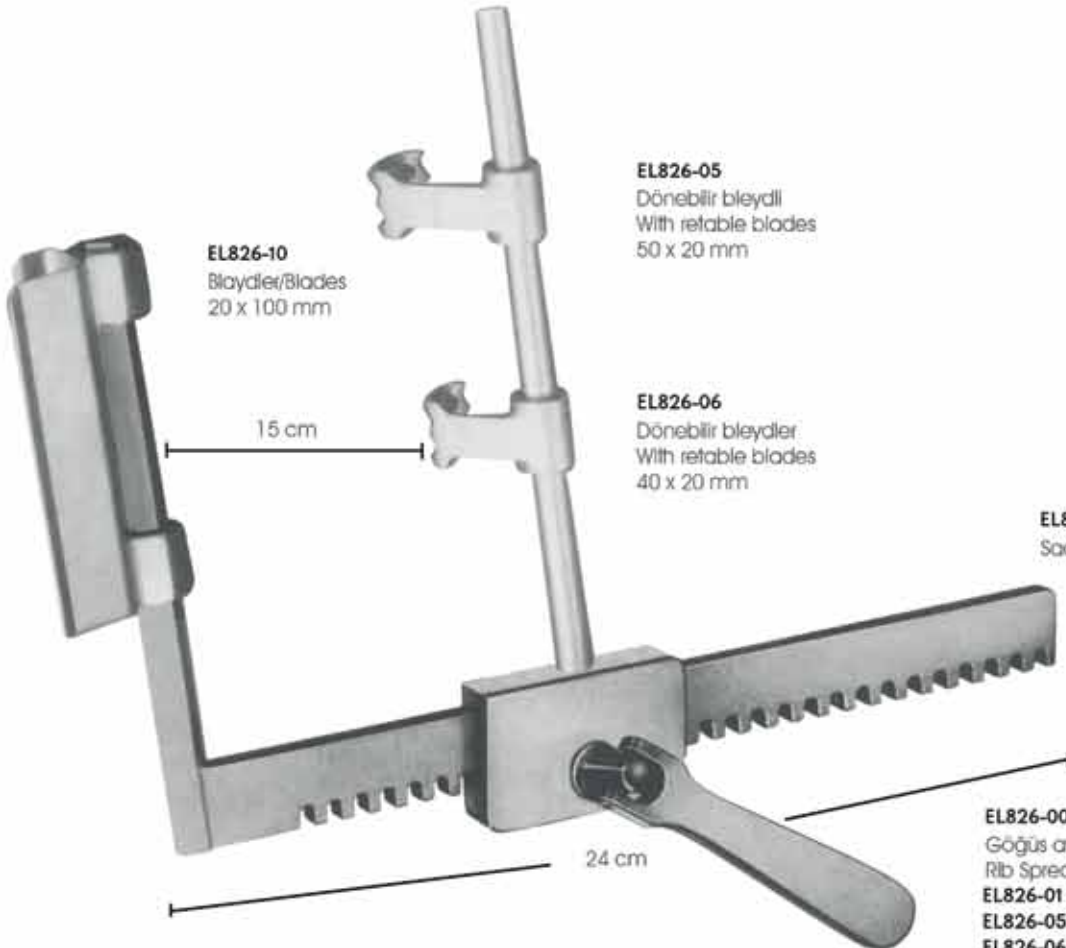

EL826-10
Bleydler/Blades
20 x 100 mm

EL826-05
Dönebilir bleydli
With retable blades
50 x 20 mm

EL826-06
Dönebilir bleydler
With retable blades
40 x 20 mm

EL826-01
Sadece ekartör/Retractor only

EL826-00
Göğüs ayırıcı komple
Rib Spreader complete
EL826-01 Sadece ekartör/Retractor only
EL826-05 Bleyd/Blade
EL826-06 Bleyd/Blade
EL826-10 Bleyd/Blade

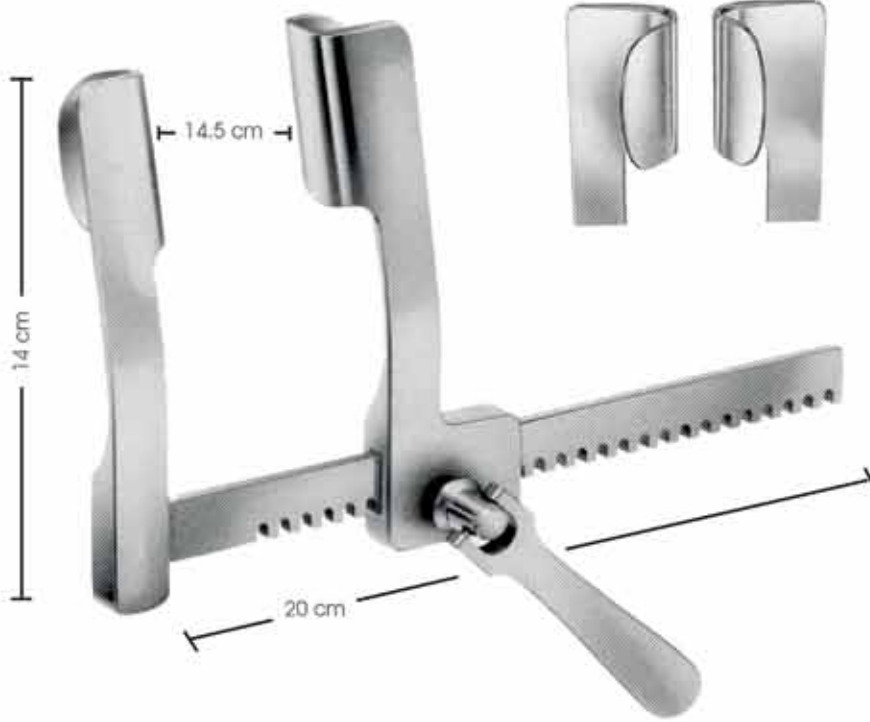

COOLEY
EL828-02
Bleydler/Blades 21 x 45 mm
Çocuklar için/For children

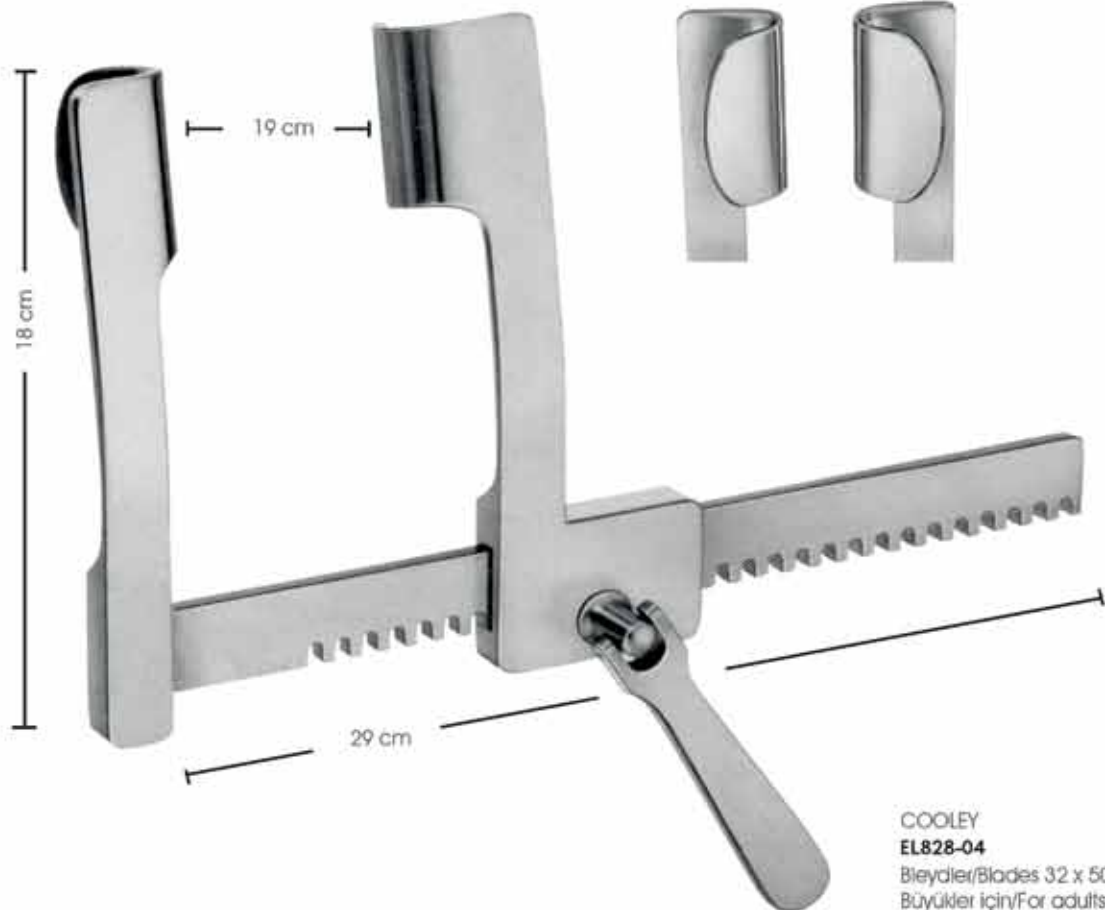

COOLEY
EL828-04
Bleydler/Blades 32 x 50 mm
Büyükler için/For adults



Sternum ekartör veya mamma interna'nin operasyonuna hazırlanması için kullanılır.
Used as Sternum retractor or used for preparation of the arteria mamma interna.

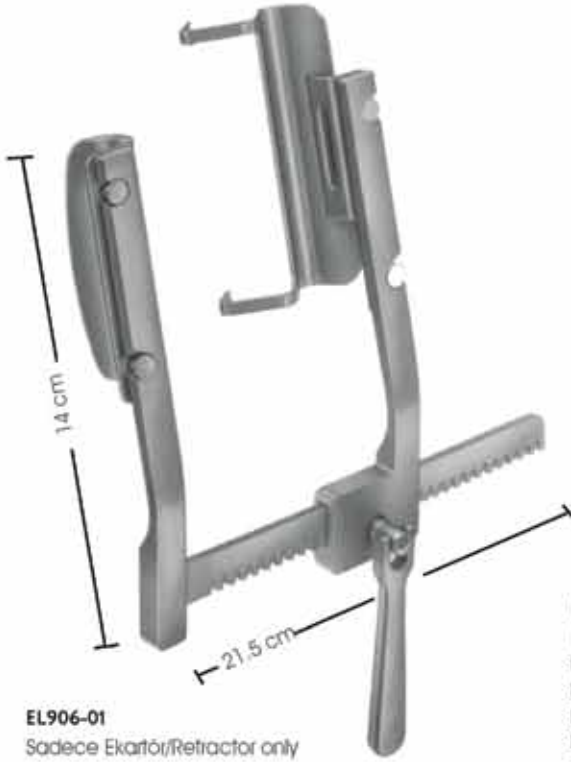

EL906-00
Mamma ekartörü komple/Mamma retractor complete
EL906-01 Sadece ekartör/Retractor only
EL906-03 Mamma bleyd komple/Mamma blade complete
EL906-04 Sternum bleydler(Çift)/Sternum blades(Pair)
EL906-05 Sternum bleydler(Çift)/Sternum blades(Pair)

IMA Bleyd/IMA Blade

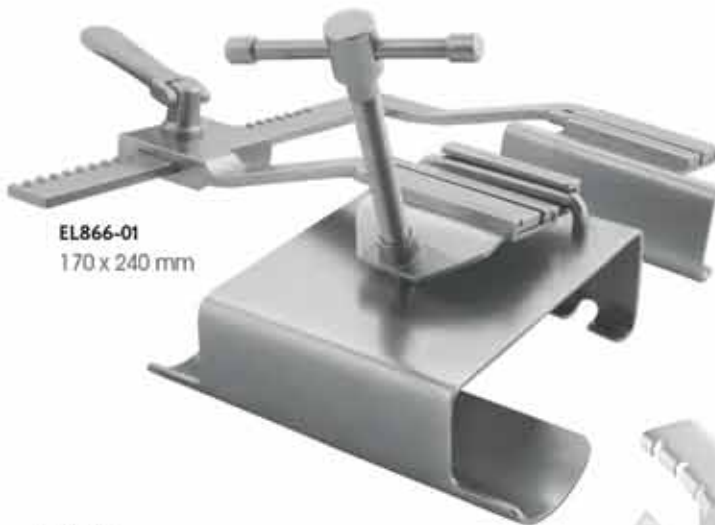

EL866-20
Torasik Ekartör komple/Thoracic retractor complete
EL866-01 Sadece ekartör/Retractor only
EL866-05 Bleyd 1 adet/Blade 1 Piece
EL866-06 Bleyd 1 adet/Blade 1 Piece
EL866-08 Bleyd 1 adet/Blade 1 Piece
EL866-09 Bleyd 1 adet/Blade 1 Piece
EL866-10 Bleyd 1 adet/Blade 1 Piece



Valf ekartör Sistemi

- Düşük operasyon platformu operasyon alanında cerrahın hareketleri için serbestlik sağlar.
- Aksesuar ve hukların sağlam tesbifi ve mükemmel uygulaması hızlı bağlantı konforu ile birleştirilmiştir.
- Taşıyıcılar kolların ve ayırıcı barların üzerine istenilen pozisyonda takılabilir veya sabitlenebilir.
- Yeni derin valf ekartör dizaynı derin göğüs kafesine sahip hastalarda çalışmak için uygundur.

Valve Retractor System

- The low operating platform provides freedom for surgeon movements in operation area.
- Strong fixation of accessories and hooks and excellent application combined with fast connection comfort.
- Carriers, can be fitted or fixed in any position on the arms and distinctive bars.
- The new deep-valve design of retractor is optimized to work on patients with deep rib cage.



EL864-05 21 x 20 cm
Sadece Ekartör/Retractor only

- EL864-00** Komple/Complete
EL864-05 Sadece ekartör/Retractor only
EL864-06 Bleyd 2 adet/Blade 2 piece
EL864-07 Bleyd 2 adet/Blade 2 piece
EL864-08 Bleyd 4 adet/Blade 4 piece
EL864-09 Bleyd 4 adet/Blade 4 piece
EL864-11 Bağlantı klempli 3 adet/Fixation clamp 3 piece
EL864-13 Ekartör 2 adet/Retractor 2 piece
EL864-14 Ekartör 2 adet/Retractor 2 piece
EL864-15 Ekartör 2 adet/Retractor 2 piece



EL864-11
Bağlantı elemanı
Joint piece



EL864-08 30 x 28 mm
EL864-09 40 x 28 mm



EL864-06 30 x 100 mm
EL864-07 40 x 100 mm



EL864-13 Küçük/Small 18 x 52 mm
EL864-14 Orta/Medium 18 x 80 mm
EL864-15 Büyük/Large 22 x 80 mm





EL830-06
Bleydler/Blades 75 x 75 mm



EL830-05
Bleydler/Blades 42 x 65 mm

EL830-02
Sadece Ekartör/Retractor only

- EL830-01** Komple/Complete
EL830-02 Sadece ekartör/Retractor only
EL830-05 Bleyd(çift)/Blade(pair)
EL830-06 Bleyd(çift)/Blade(pair)



MINI FINOCHIETTO
EL875-00A
Bleydler/Blades 6 x 7 mm



FINOCHIETTO
EL875-02A
Bleydler/Blades
12 x 15 mm



FINOCHIETTO
EL875-05A
Bleydler/Blades
28 x 30 mm



FINOCHIETTO
EL875-07A
Bleydler/Blades
31 x 45 mm



FINOCHIETTO
EL875-10A
Bleydler/Blades
42 x 61 mm

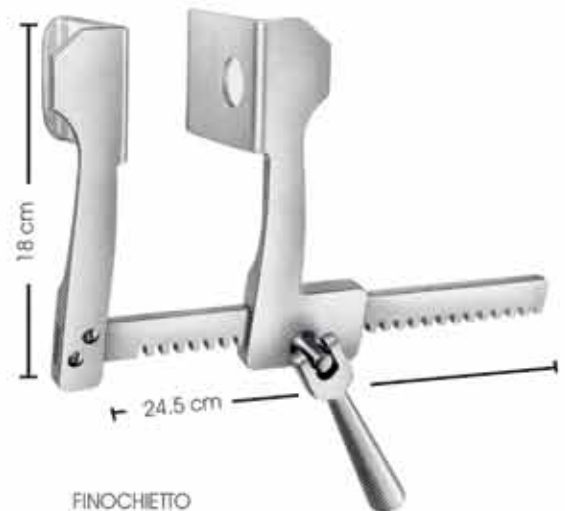

FINOCHIETTO
EL875-13A
Bleydler/Blades
74 x 64 mm

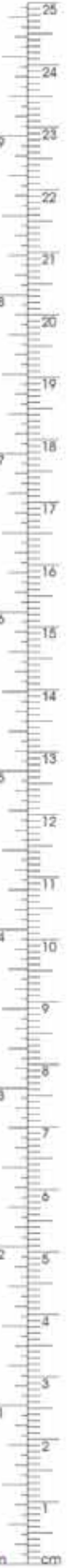



COOLEY
EK695-00P
İnce dişli/Slightly serrated
26.5 cm



COOLEY
EK695-01P
İnce Dişli/Slightly serrated
26.5 cm



COOLEY
EK695-02P
Sağ İnce dişli/Right, slightly serrated
27 cm



45 x 48 mm

1/2

COOLEY
EK696-02P
Sağ/Right
27 cm



25 x 46 mm

1/2

COOLEY
EK697-02P
Sol/Left
28 cm





COOLEY
EK695-00 45 x 30 mm
EK695-01 45 x 35 mm
EK695-02 45 x 48 mm
İnce dişli/Slightly serrated
26.5 cm



COOLEY
EK696-00 45 x 30 mm
EK696-01 45 x 35 mm
EK696-02 45 x 48 mm
Dişsiz/Unserrated
24.5 cm



COOLEY
EK697-02 25 x 46 mm
Sol/Left
28 cm

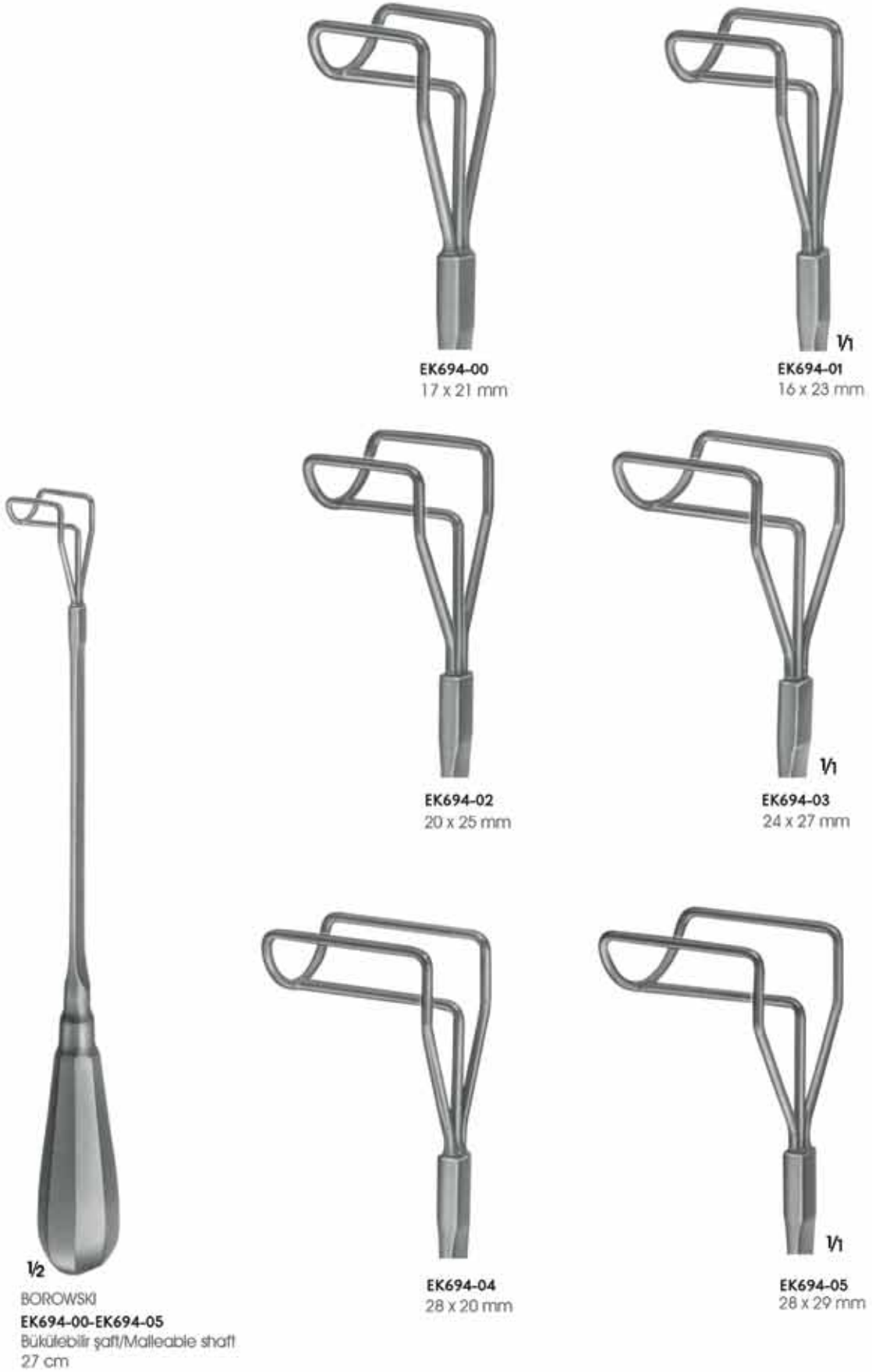

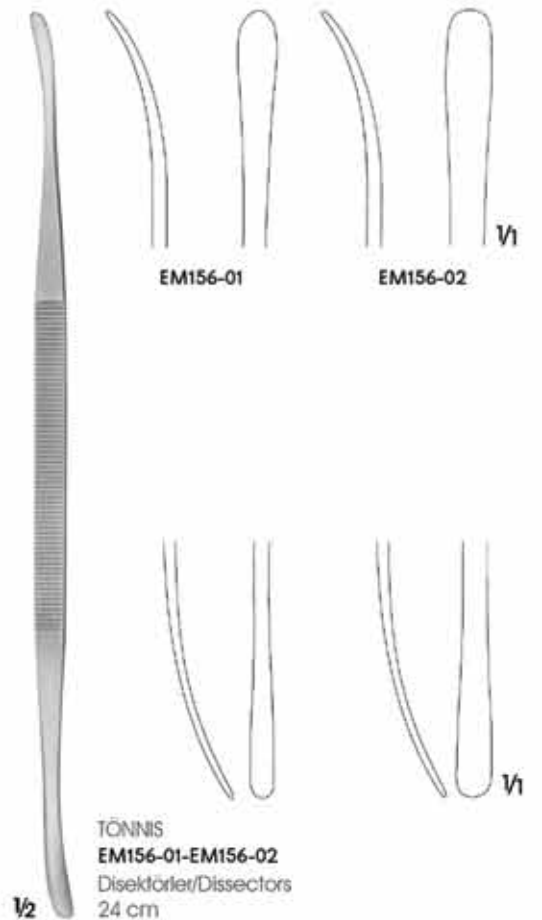
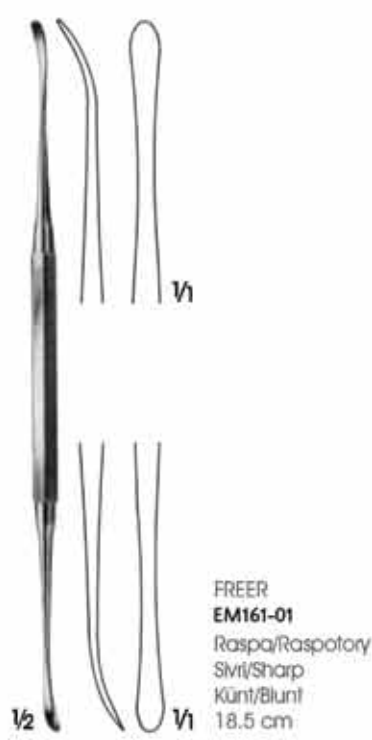
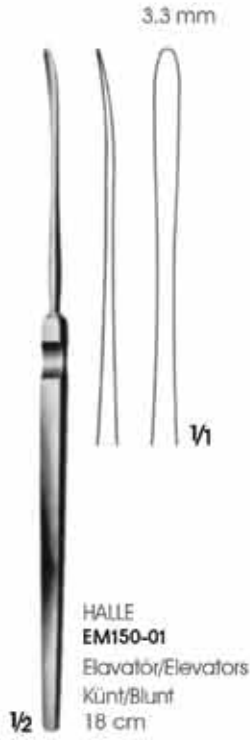

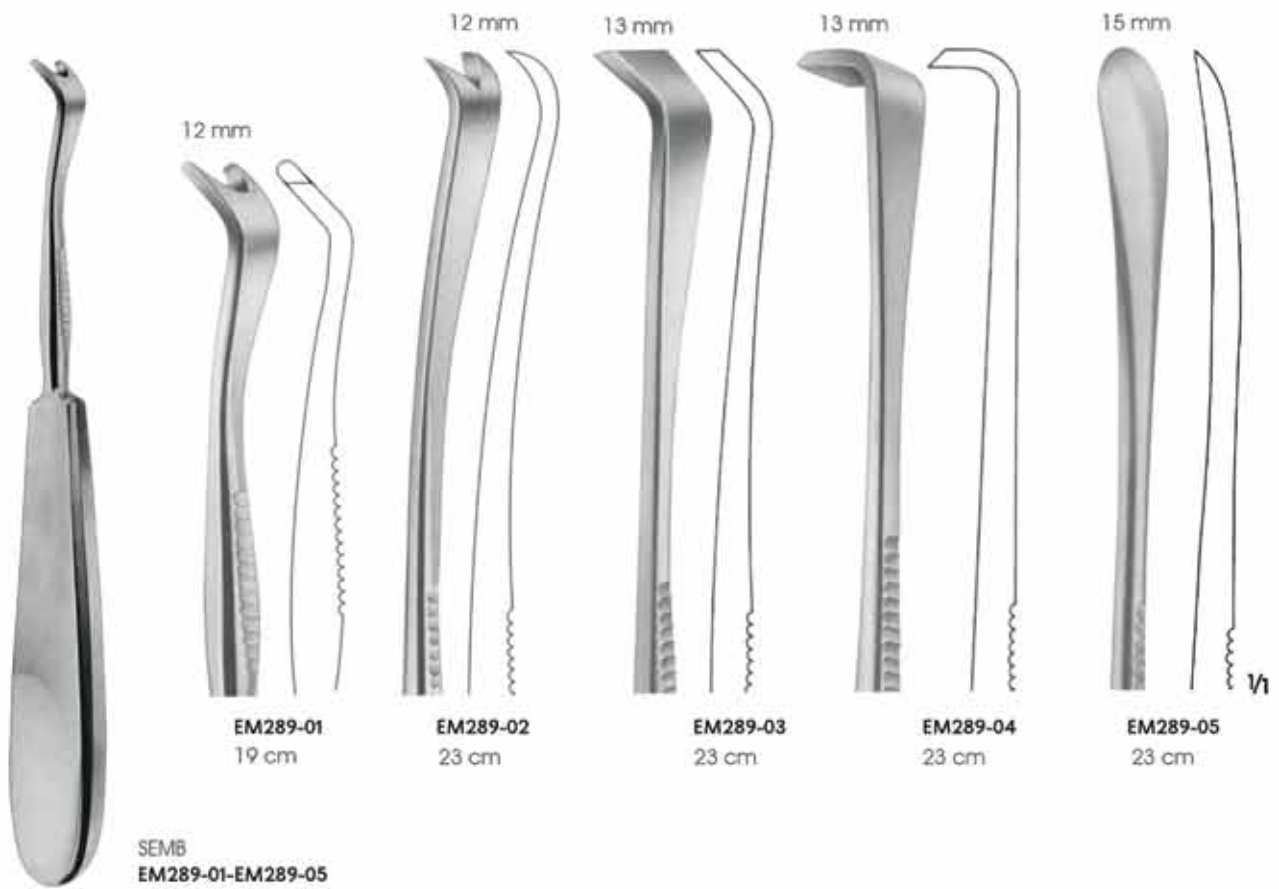

EM289-01 19 cm
EM289-02 23 cm
EM289-03 23 cm
EM289-04 23 cm
EM289-05 23 cm

SEMB
EM289-01-EM289-05

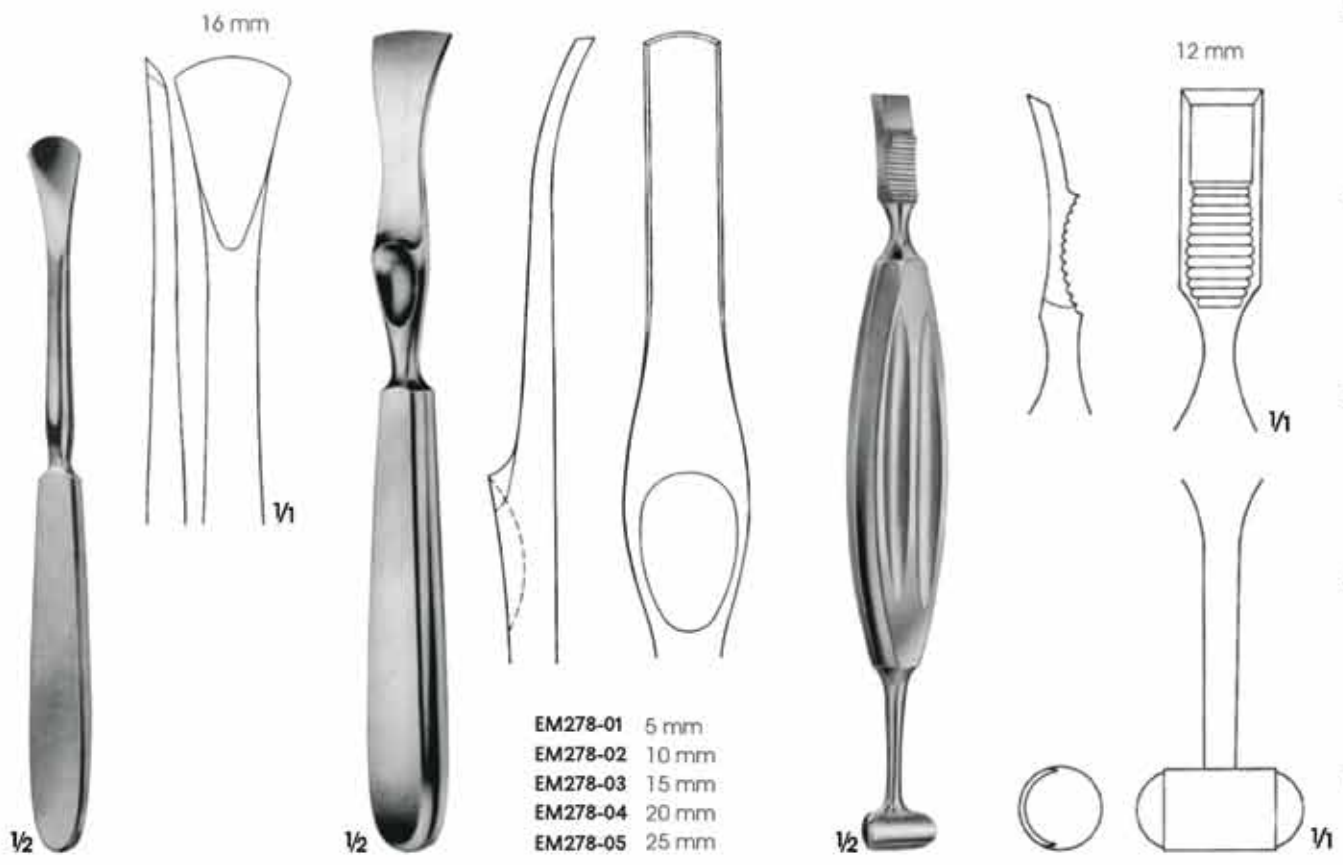

LANGENBECK
EM256-01
19 cm

LAMBOTTE
EM278-01-EM278-05
21.5 cm

ALEXANDER
EM285-00
21 cm



DOYEN
EM290-01-EM291-01
Çocuklar için/For children
17.5 cm



DOYEN
EM290-02-EM291-02
Büyükler için/For adults
17.5 cm



DOYEN
EM292-01-EM293-01
24 cm



EJ500-03
Esnek plastik sonda ucu
Flexible plastic probe tip



EJ500-04
Ø 3 mm
Metal sonda ucu
Metal Probe tip



EJ500-05
Ø 6 mm



EJ500-06
Ø 9 mm



EJ500-07
Ø 12 mm



EJ500-08
Ø 15 mm



NABATOFF
EJ500-10
Sadece sap
Handle only



NABATOFF
EJ500-11 90 cm
EJ500-12 120 cm
Esnek kablo/Cable flexible

NABATOFF

- EJ500-00** Damar temizleme seti/vein stripper set, consisting of
- EJ500-01** Metal kutu/Metal case
- EJ500-11** Esnek kablo 90 cm/Flexible cable 90 cm
- EJ500-03** Esnek plastik sonda ucu/Flexible plastic probe tip
- EJ500-04** Metal sonda ucu/Metal Probe tip
- EJ500-05** Metal uç/Metal end Ø 6 mm
- EJ500-06** Metal uç/Metal end Ø 9 mm
- EJ500-07** Metal uç/Metal end Ø 12 mm
- EJ500-08** Metal uç/Metal end Ø 15 mm
- EJ500-10** Esnek kablo sapı/Handle for flexible cable



VARADY

EJ502-00 Mini damar temizleme seti
Mini vein stripper set

- EJ500-00** Metal kutu/Metal case
- EJ502-01** Esnek kablo 45 cm/Flexible cable 45 cm
- EJ502-03** Metal uc/Metal end Ø 3 mm
- EJ502-04** Metal uc/Metal end Ø 4 mm
- EJ502-05** Metal uc/Metal end Ø 5 mm



VARADY

EJ502-01
Esnek kablo
Flexible cable
45 cm



EJ502-03
Ø 3 mm



EJ502-04
Ø 4 mm



EJ502-05
Ø 5 mm

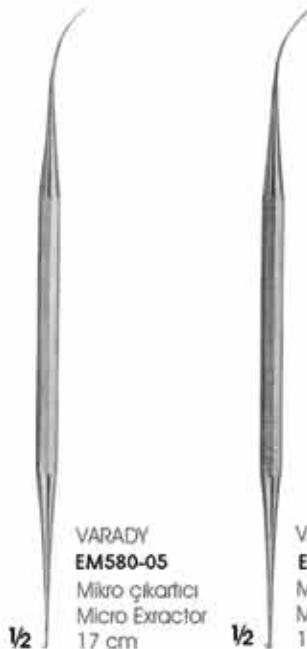

VARADY
EM580-05
Mikro çıkartıcı
Micro Extractor
17 cm



VARADY
EM580-06
Mini çıkartıcı
Mini Extractor
17 cm



VARADY
EM580-07
Mikro spatula,
çift taraflı
Micro spatula,
double ended
17.5 cm



VARADY
EM580-00
Disektor
Dissector
18 cm



VARADY
EM580-01
Çıkartıcı
Extractor
18 cm



VARADY
EM580-02
Çıkartıcı
Extractor
18 cm

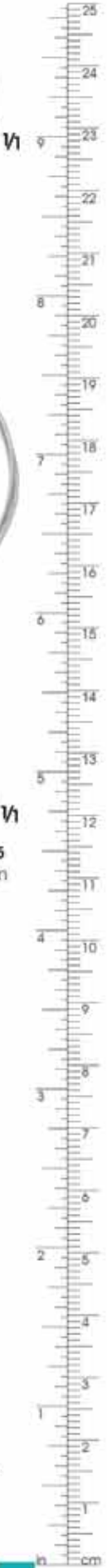



DE BAKEY

EJ510-02-EJ510-17 .17 19 cm

EJ511-02-EJ511-17 .17 38 cm

Damar dilatörleri, bükülebilir
Vascular dilators, malleable

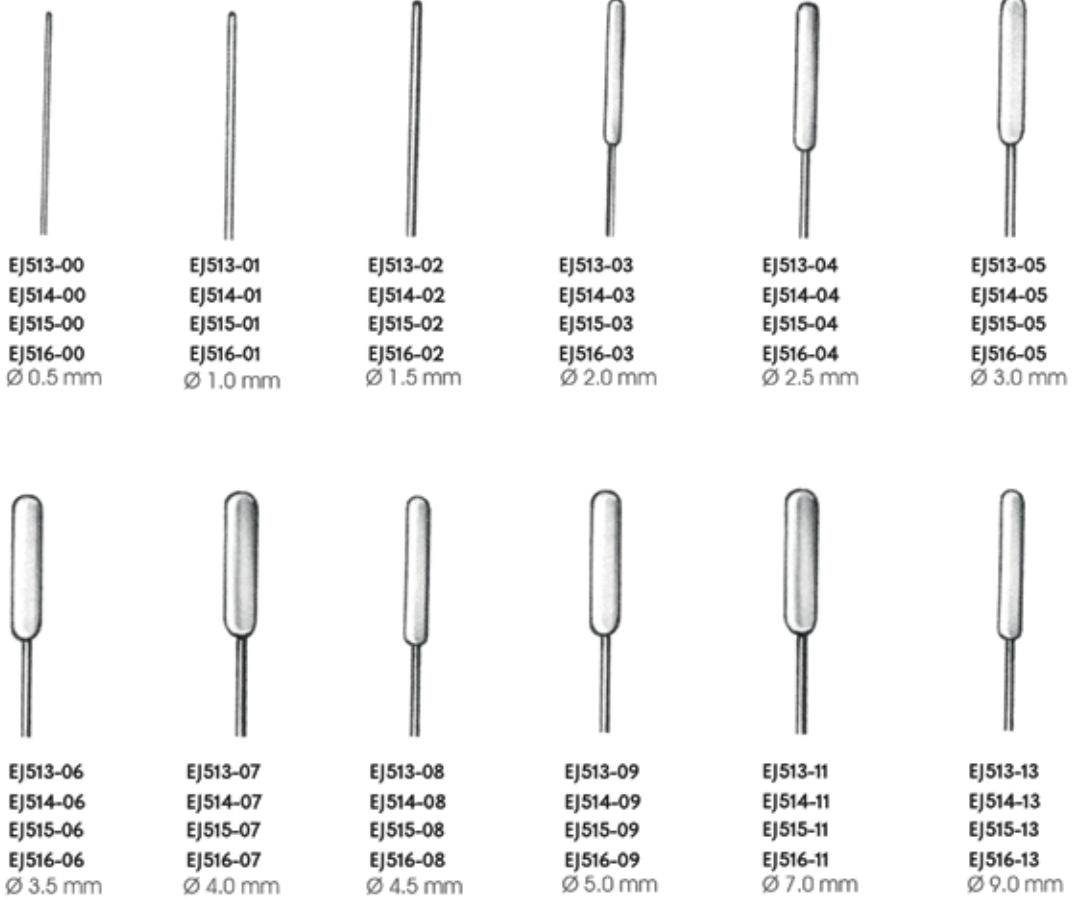

GARRET
EJ513-00-EJ513-13 14 cm
EJ514-00-EJ514-13 19 cm
EJ515-00-EJ515-13 21 cm
EJ516-00-EJ516-13 35 cm
Bükülebilir/Malleable



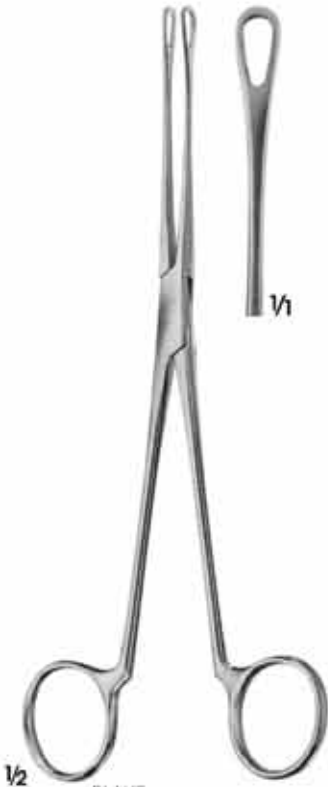

1/2
BLAKE
EE620-00
Emboli tutma pensil
Embolus grasping forceps
20.5 cm



1/2
EJ530-05
Sadece klavuz
Guide only



1/2
EJ530-06
Sadece klavuz
Guide only



1/2
RUMEL-BELMONT
Turnikeler/Tourniquets
EJ530-01 Ø 4.0 mm
EJ530-02 Ø 6.4 mm
32.5 cm



EJ525-12
EJ525-01-EJ525-09
Sap/For handle
11 cm



EJ525-01-EJ525-09
Endarterektomi sıyıcı
Endarterectomy strippers
55 cm



EJ525-01
2 mm



EJ525-02
3 mm



EJ525-03
4 mm



EJ525-04
6 mm



EJ525-05
7 mm



EJ525-06
8.5 mm



EJ525-07
10 mm



EJ525-08
12 mm



EJ525-09
14 mm



EJ520-01-EJ520-04
Damar sulama kanülleri,
Paslanmaz çelik
Vessel irrigating cannulae,
stainless steel
15 cm



EJ520-01
Ø 3 mm



EJ520-02
Ø 4 mm



EJ520-03
Ø 5 mm



EJ520-04
Ø 6 mm



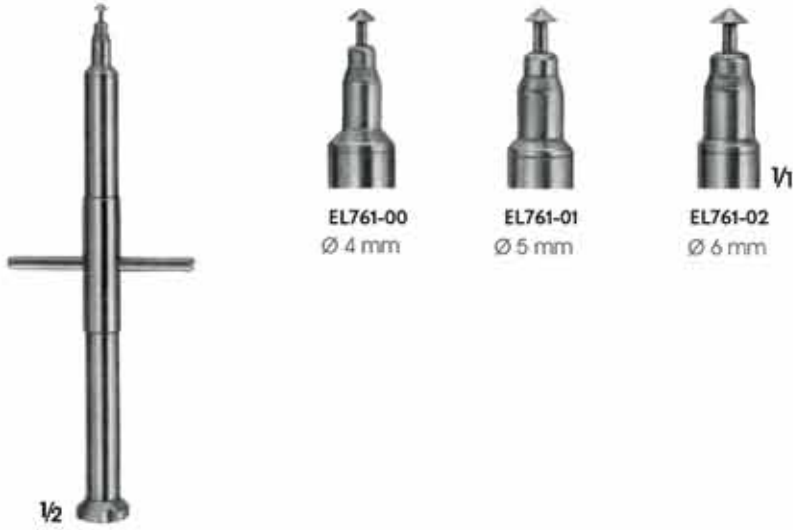

EL761-00-EL761-02
Aort pançları/Aorta punches
14 cm

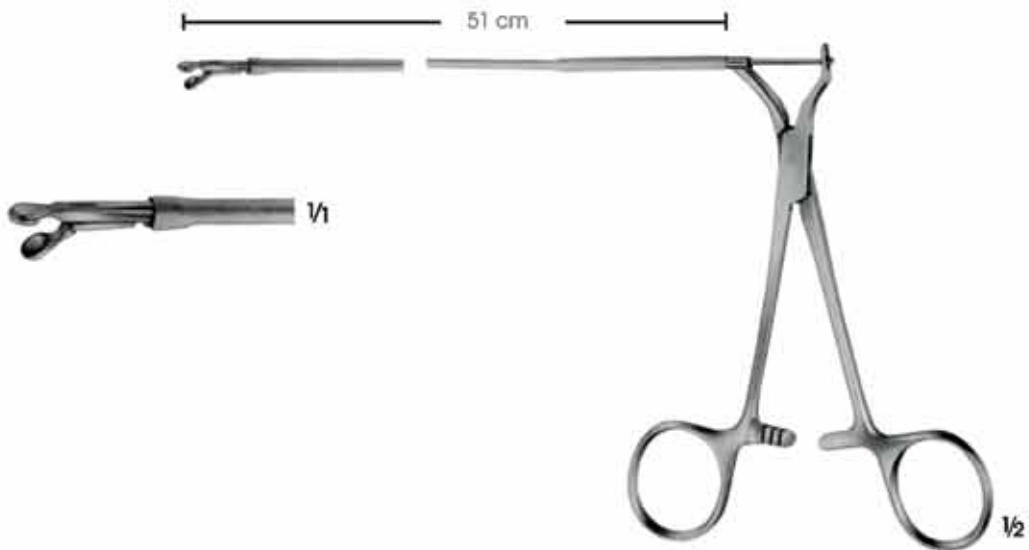

SCHULZ
ER850-01
Esnek millî biyoptom, 51 cm uzunluğunda
Ø 3 mm yuvarlak çeneli
Bioptome, with flexible shaft 51 cm long,
with round jaws Ø 3 mm

Buldog pens sürücüsü, ince ve hafif eğri yapısı ile tünel boyunca kolay ilerleme sağlar.
Buldog pensini güvenli şekilde kavrar.

The slight curvature of the introducer forceps permits handling during tunneling. Here the prosthesis can be drawn in by applying the introducer forceps directly to the prosthesis (alloplastic prosthesis) or can be drawn in by means of the buldog clamp (autologous/homologous prosthesis). Thanks to the interlocking fit, the buldog clamp rests non-displaceable and securely in the mouth of the introducer forceps.

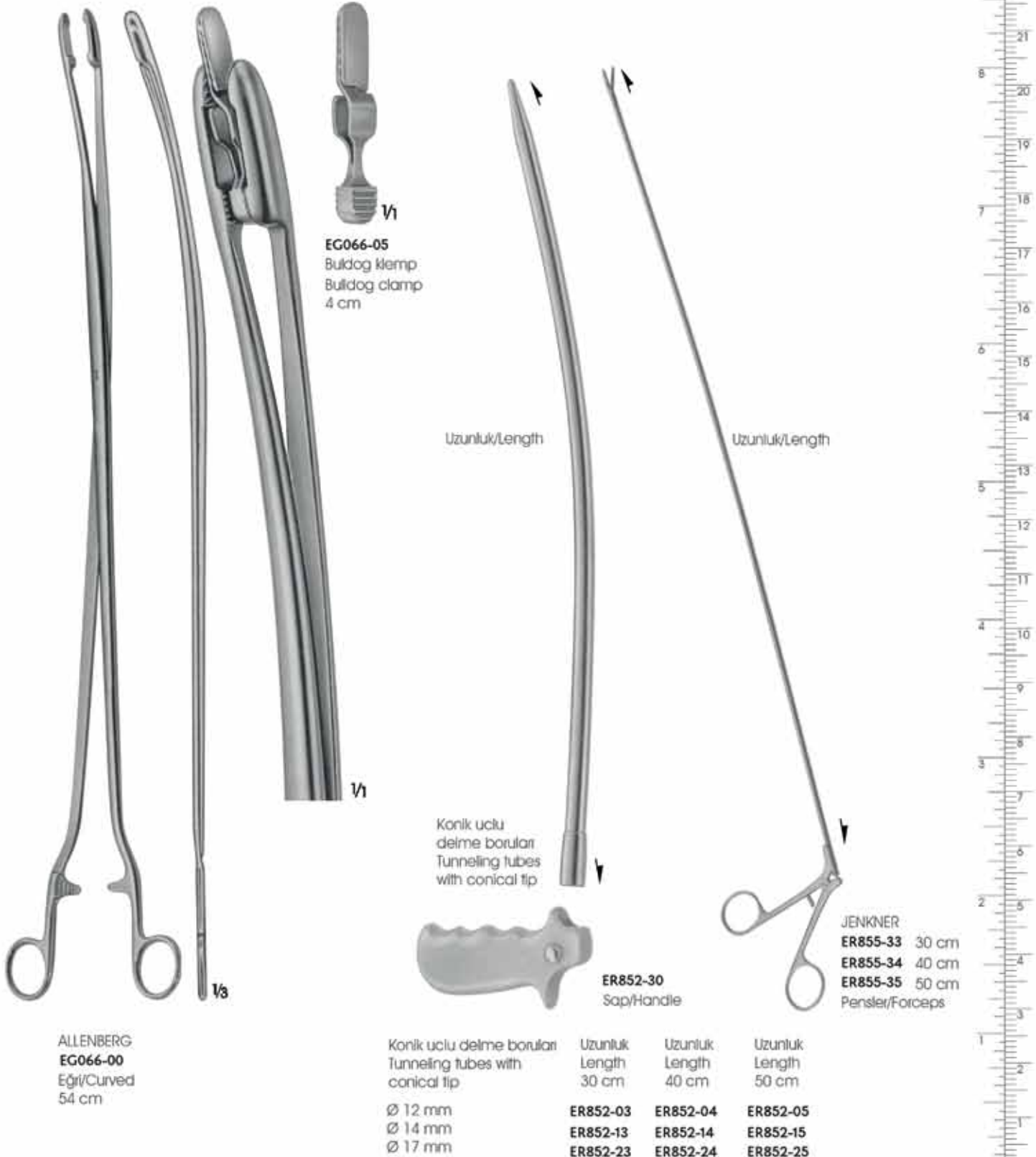



WITT
EJ710-00 1.5 x 35 mm
EJ710-02 1.5 x 51 mm
Sternal delme iğnesi.
Luer bağlantılı
Sternal puncture needle
with Luer cone

1/1



Tek ağız tırtılı
One jaw serrated

BRAUN-STADLER
EC604-00
Çocuklar için Sternum makası
Sternum shears for children
20 cm

1/1

1/2



SCHUMACHER
EP505-00
Sternum makası
Sternum shears
21 cm

1/2



LEBSCHKE
EM598-00
Sternum çizili
Sternum chisel
20 cm

1/2



Ø 15 mm

FINSTERER
EJ600-00
Kombine aspiratör ucu
ve irigasyon kanülü
Combined suction and
irrigation cannula
32 cm

Olive
Ø 9-13 mm

1/2



Ø 10 mm

YANKAUER
EJ301-00 Ø 2.0 mm
Merkez delikli/With central bore
28.5 cm

Olive
Ø 7-9 mm

1/2



Ø 9 mm

DE BAKEY
EJ304-00
Merkez delikli, Ø 3.0 mm yanıl yuvalı
With central bore, Ø 3.0 mm with lateral
slots
27.5 cm

Olive
Ø 6-10 mm

1/2



Ø 5 mm

DE BAKEY
EJ306-00
Parmak kumandalı, temizleme teli
With finger cut-off and stylet
27 cm

Olive
Ø 9 mm

1/2



Ø 5 mm

DE BAKEY
EJ708-00
Parmak kumandalı, temizleme teli
With finger cut-off and stylet
16 cm

Olive
Ø 9 mm

1/2







SAUERBRUCH
EP500-01
Çocuklar için
For children
24 cm

EP500-02
Büyükler için
For adults
27 cm



GLUCK
EP510-00
19 cm



EP513-01
23 cm



GIERTZ-STILLE
EP502-01
25 cm



BRUNNER
EP520-01
Üniversal model
Universal pattern
34 cm



BETHUNE
EP515-00
34 cm



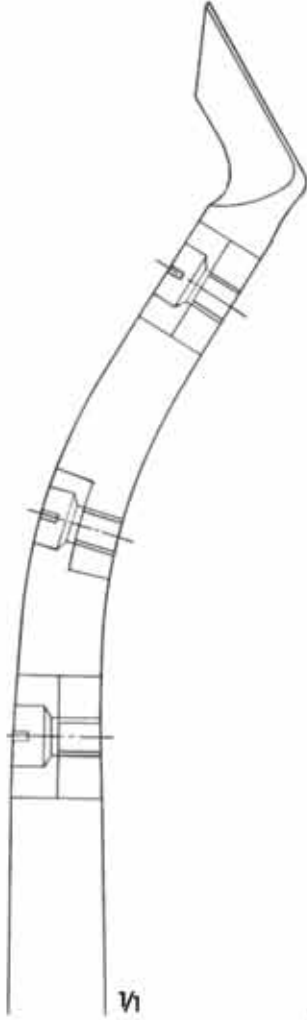

LISTON-KEY-HORSLEY
EP379-01
S şekilli, arka kaburga uçları için
S-Shaped for posterior rib ends
25.5 cm

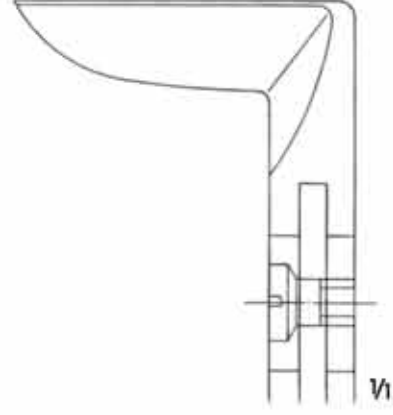

LISTON -STILLE
EP378-01
Açılı/Aggled
26.5 cm

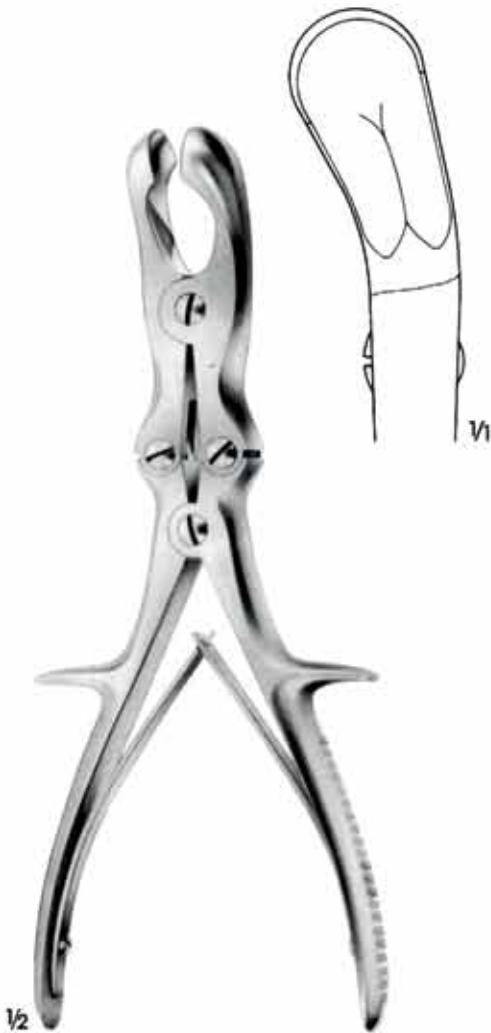

**SEMB
EP325-01**
Kemik ronjur
kaba kemikleri için
Rib rongeur to shorten
the rib stumps.
24 cm



**SAUERBRUCH-CORYLLOS
EP333-01-EP335-01**
Kemik ronjur
kaba kemikleri için
Rib rongeur to shorten
the rib stumps
31 cm



EM

Raspalar, Disektörler ve Elevatörler
Raspatories, Dissectors and Levers



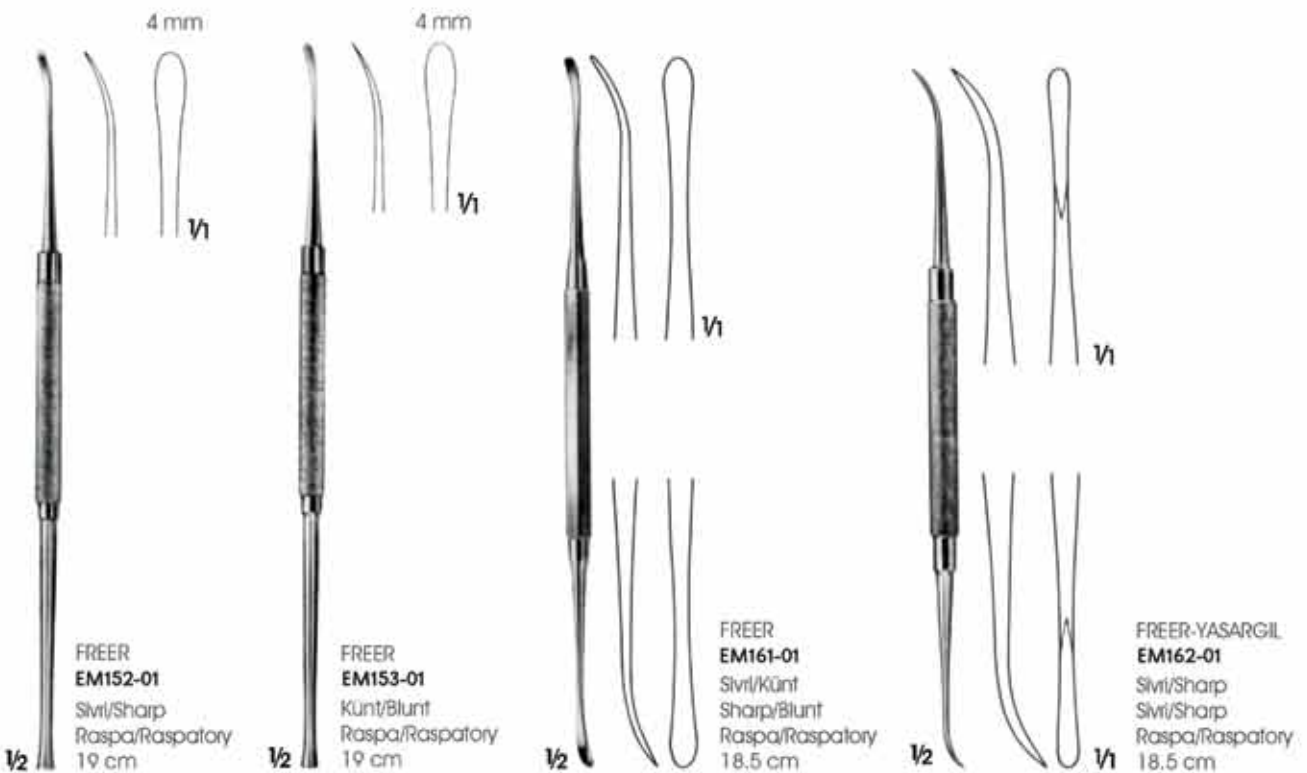
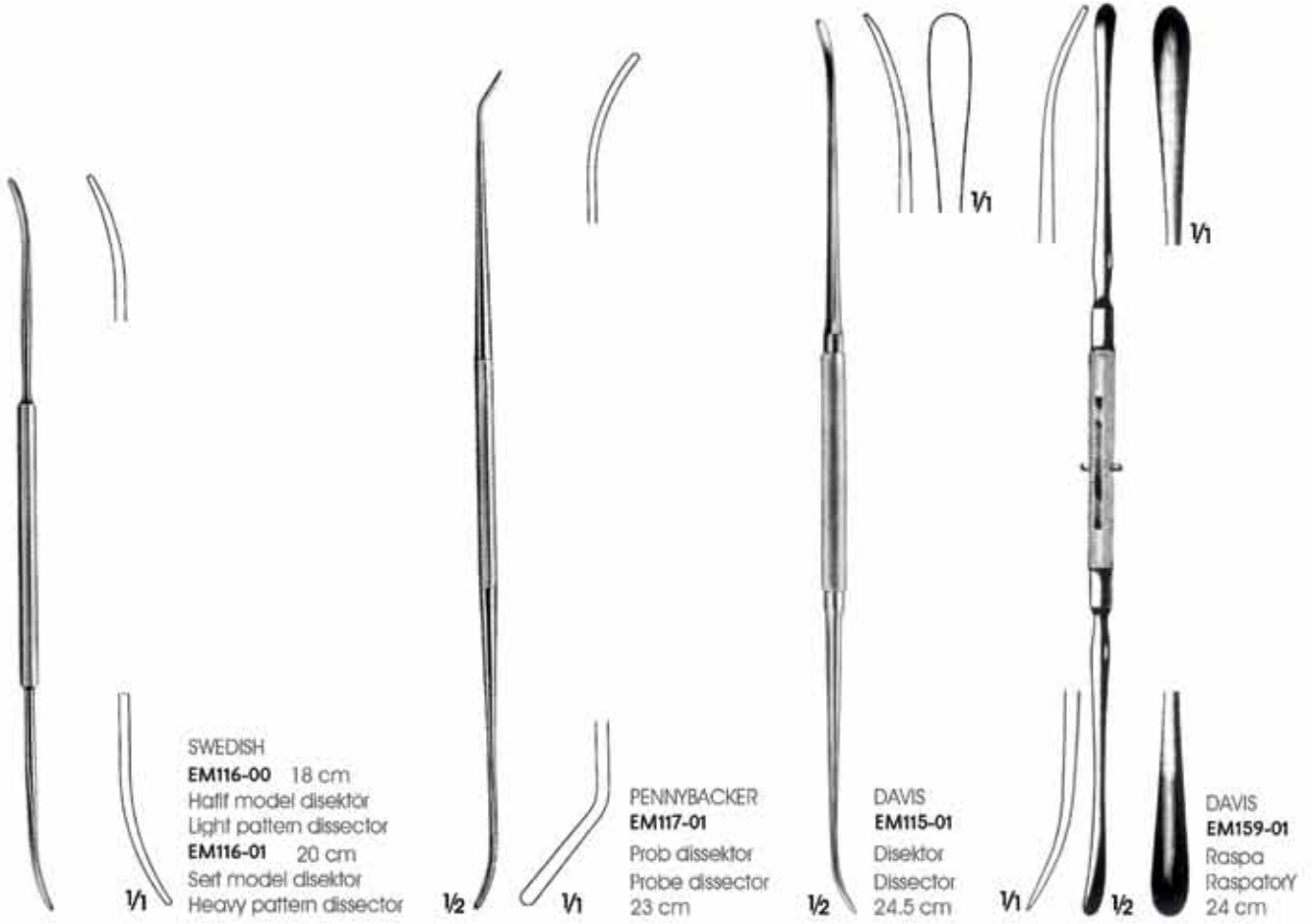

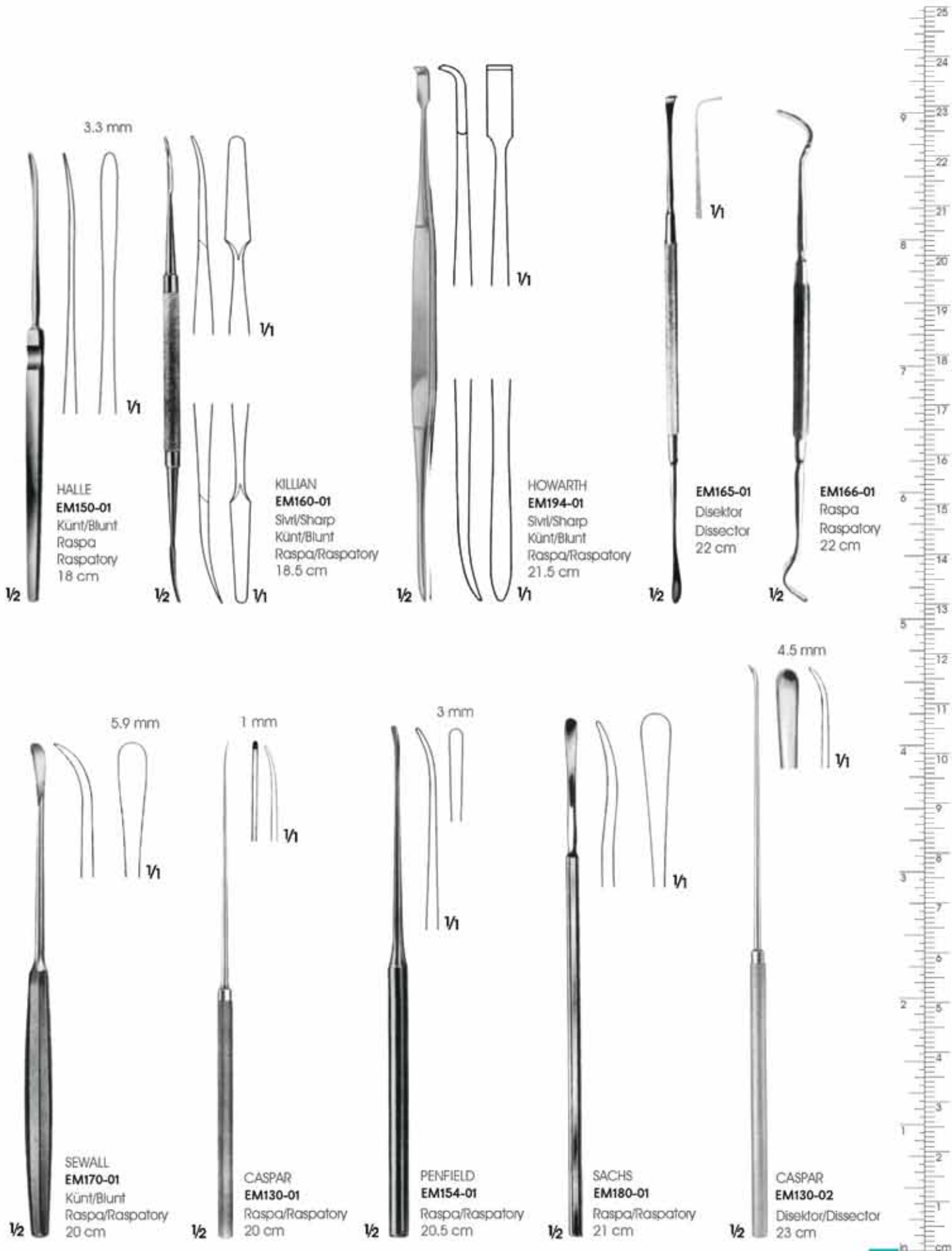

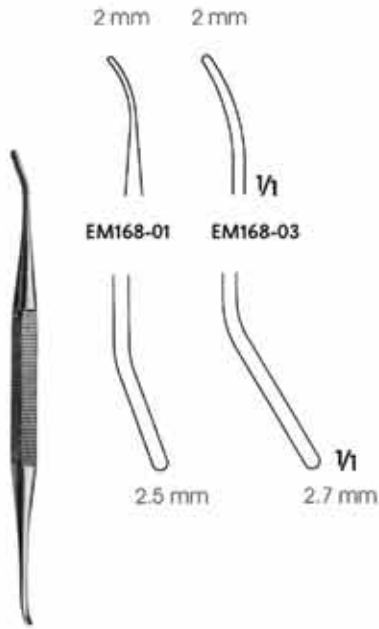

WATSON-CHEYNE
EM168-01 13 cm
EM168-03 19 cm
Raspalar/Raspatory

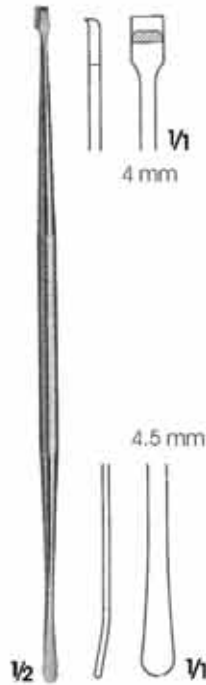

FREER
EM167-00
Raspa/Raspatory
18 cm



SYME
EM169-00 Sivi/Sharp
Raspa/Raspatory
18.5 cm

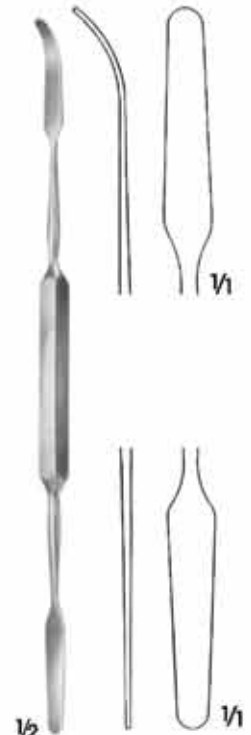

MAC DONALD
EM190-01
Künt/Blunt
Künt/Blunt
Dissektor/ Dissector
18.5 cm

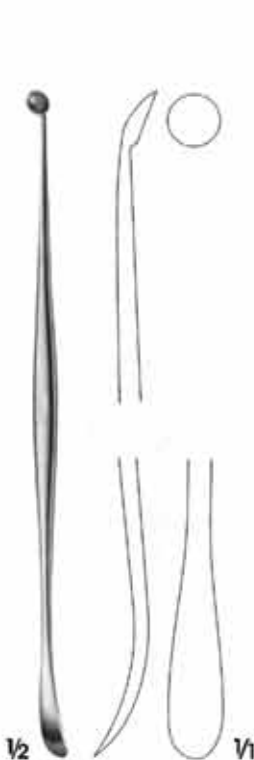

PENFIELD
EM178-00
Dissektor/Dissector
Çift uçlu/Double-Ended
17.5 cm



PENFIELD
EM175-01 Fig.2
Dissektor/Dissector
Çift uçlu/Double-Ended
19.5 cm



PENFIELD
EM175-02 Fig.3
Dissektor/Dissector
Çift uçlu/Double-Ended
19.5 cm



CARTER
EM179-01
Raspa/Raspatory
21 cm



FRAZIER
EM182-00
Raspa/Raspatory
15 cm



HOEN
EM182-01
Raspa/Raspatory
15 cm



HOEN
EM182-02
Raspa/Raspatory
15 cm



FREER
EM177-01
Raspa/Raspatory
20 cm



KILLIAN
EM191-01
Sivri/Sharp
Künt/Blunt
Raspa/Raspatory
18.5 cm



O'CONNELL
EM252-00
Disektor/Dissector
Çift uçlu
Double-Ended
22 cm



MILLIGAN
EM188-01
Raspa/Raspatory
21 cm



WOODSON
EM189-01
Raspa/Raspatory
25 cm



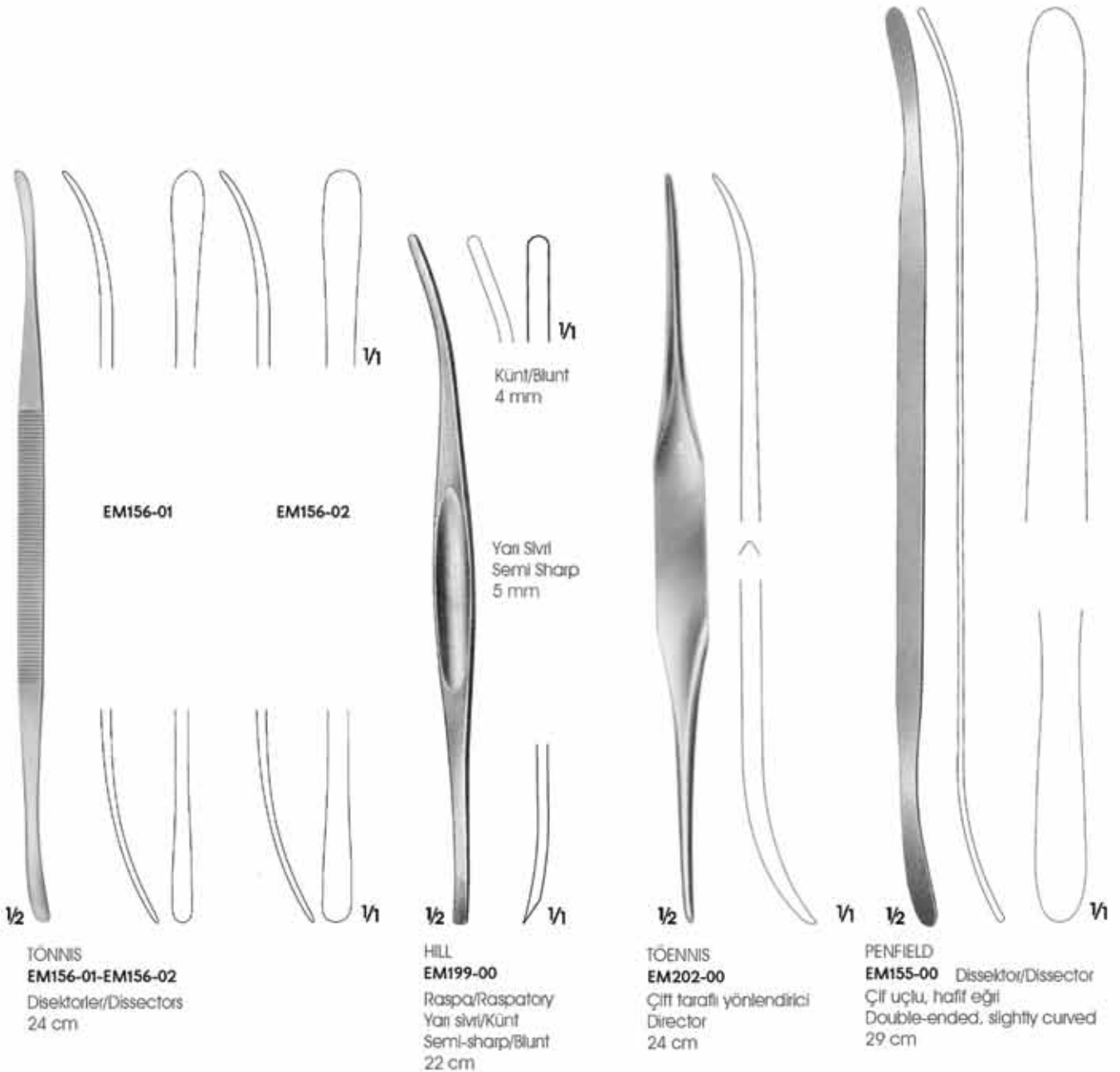

TÖNNIS
EM156-01-EM156-02
 Disektörler/Dissectors
 24 cm

HILL
EM199-00
 Raspa/Raspatory
 Yarı sivri/Künl
 Semi-sharp/Blunt
 22 cm

TÖNNIS
EM202-00
 Çift taraflı yönlendirici
 Director
 24 cm

PENFIELD
EM155-00 Disektör/Dissector
 Çift uçlu, hafif eğri
 Double-ended, slightly curved
 29 cm

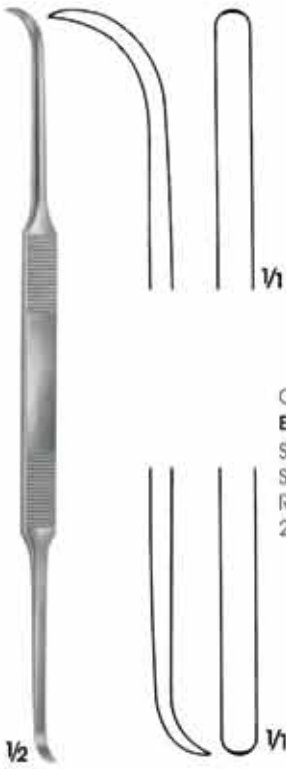

COTTLE
EM193-01
Sivri/Sharp
Sivri/Sharp
Raspa/Raspatory
20 cm



COTTLE
EM196-01
Sivri/Sharp
Sivri/Sharp
Elavator/Elavator
20 cm



PENNINGTON
EM197-01
Sivri/Sharp
Sivri/Sharp
Raspa/Raspatory
21 cm



PIERCE
EM198-01
Sivri/Sharp
Sivri/Sharp
Raspa/Raspatory
21 cm

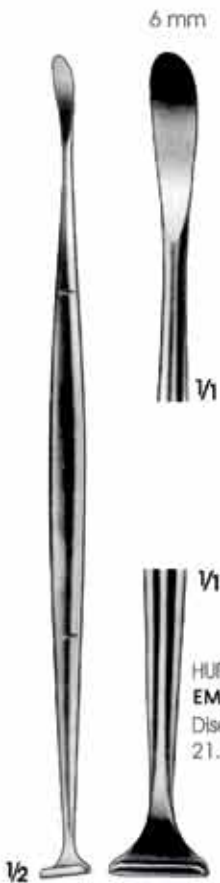

HURD
EM205-02
Disektor/Dissector
21.5 cm



HURD
EM205-04
Disektor/Dissector
21.5 cm

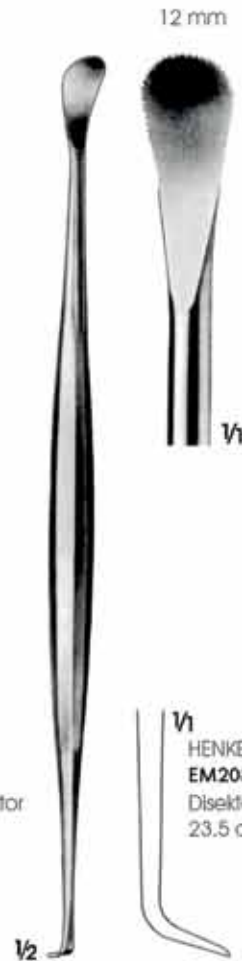

HENKE
EM208-02
Disektor/Dissector
23.5 cm



HENKE
EM208-04
Disektor/Dissector
23.5 cm



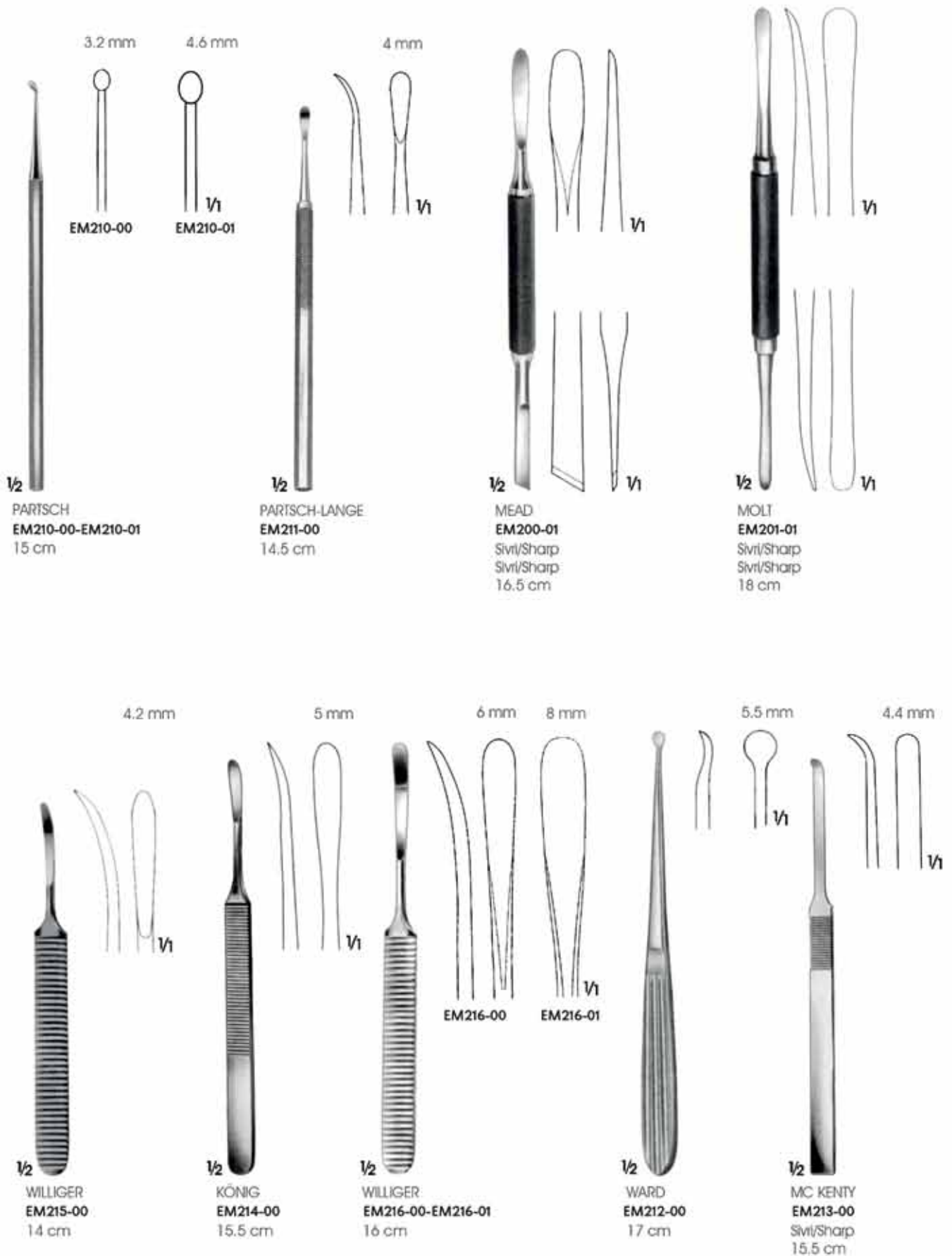

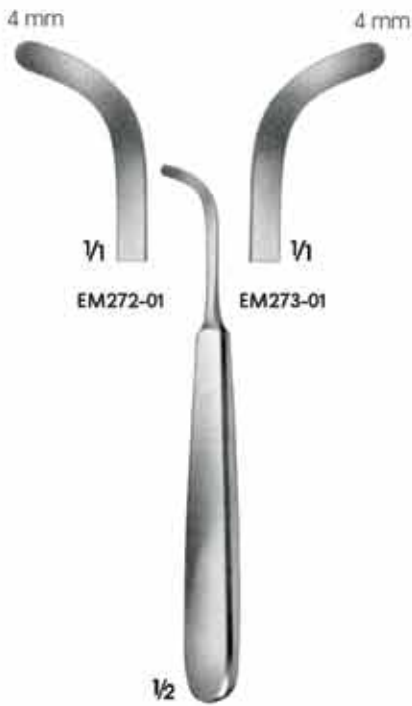

1/1
EM272-01

1/1
EM273-01

1/2
EM272-01-EM273-01
14 cm



1/2
TRELAT
EM218-00
15 cm

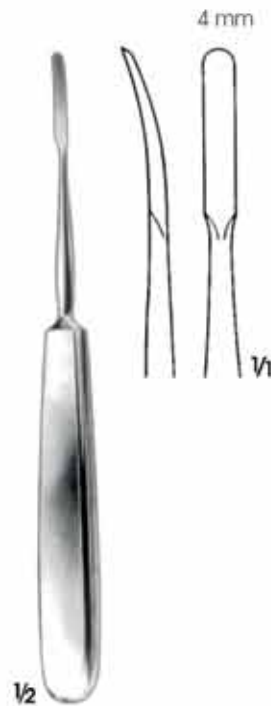

1/2
JOSEPH
EM219-01
17 cm

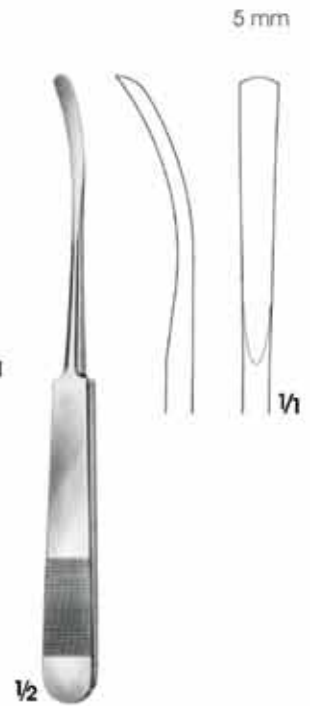

1/2
ADSON
EM237-10
16.5 cm

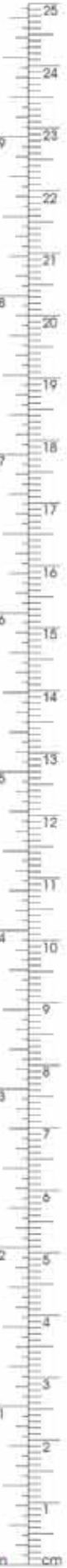

1/2
LEMPERT
EM328-01
Künt/Blunt
16.5 cm



1/2
PENNYBAKER
EM328-00
Künt/Blunt
16.5 cm

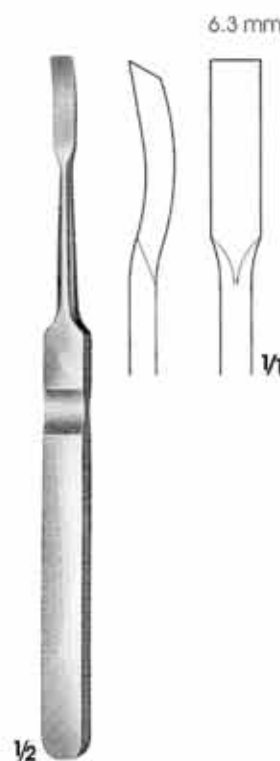

1/2
LEMPERT
EM279-00
Yarı slıvı/Semi-sharp
18.5 cm

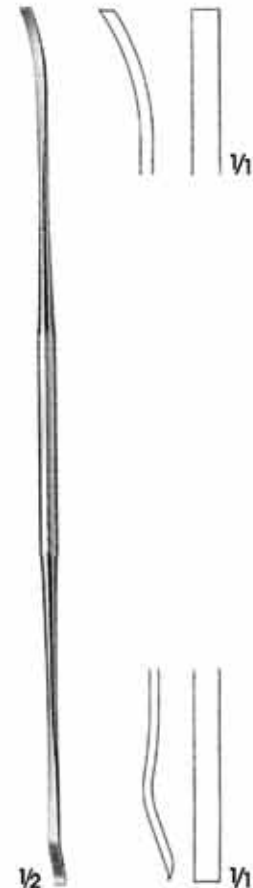

1/2
ALLEN
EM614-00
Osteofit çizli ve raspa
Osteophyte chisel and scraper
23 cm

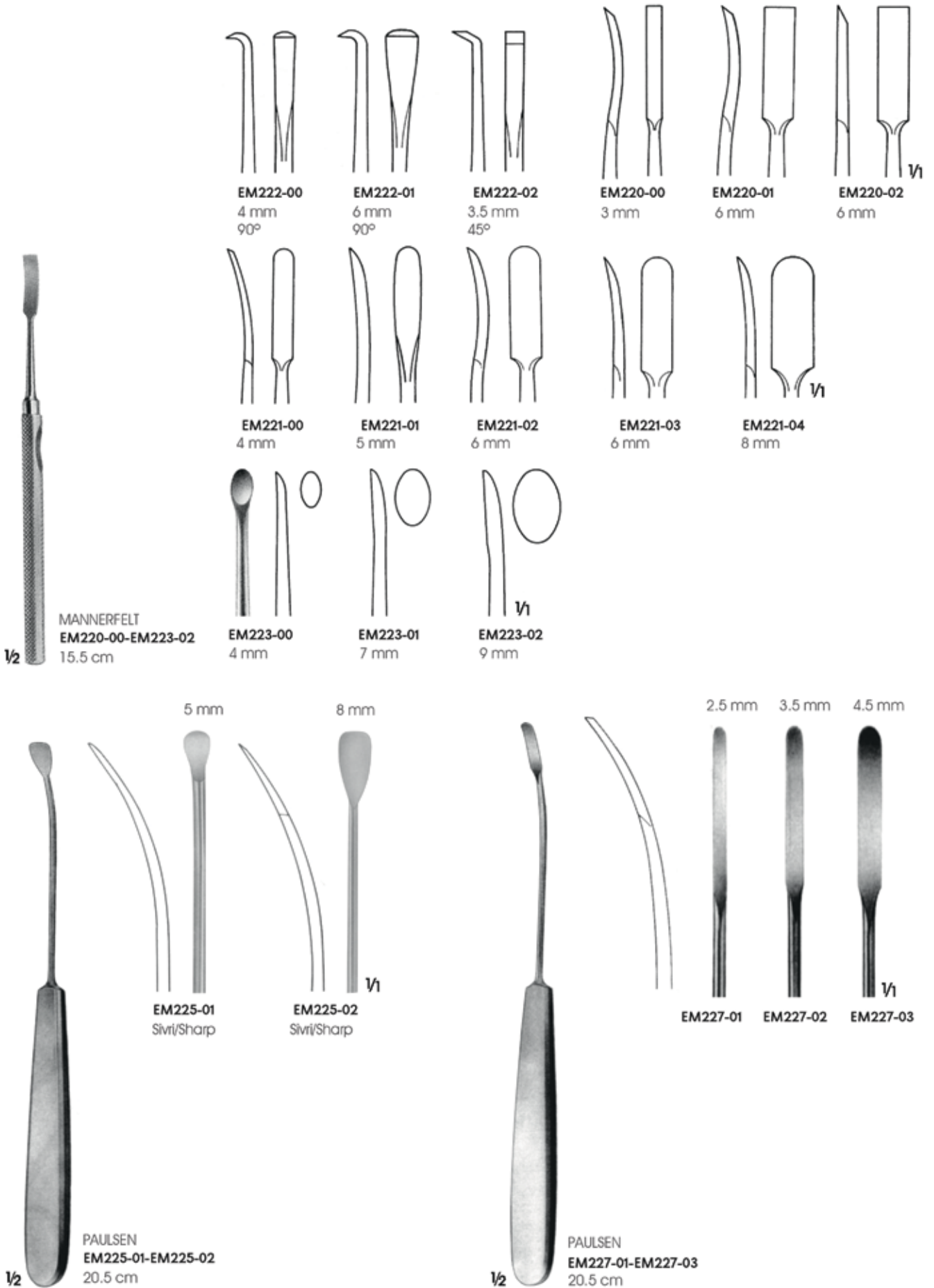

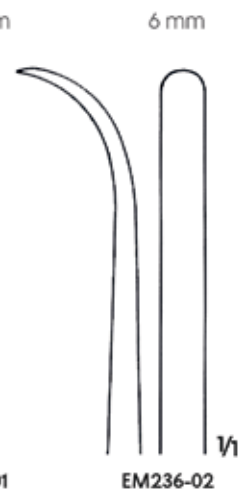
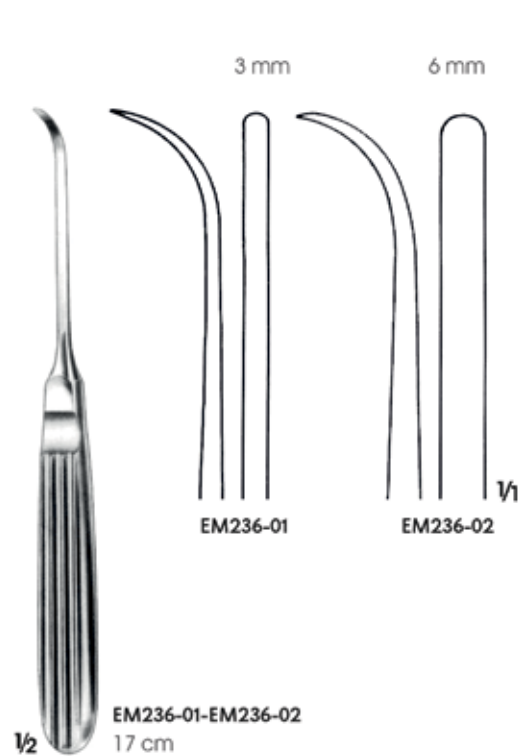
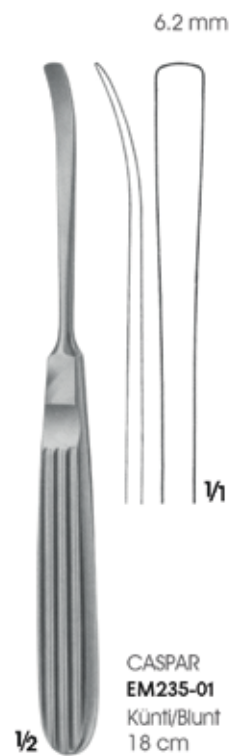
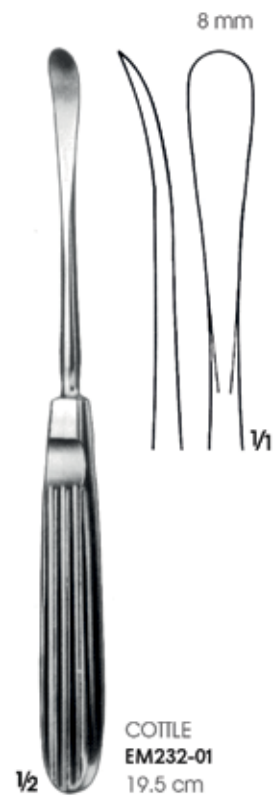
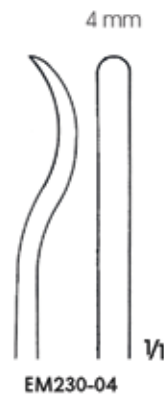
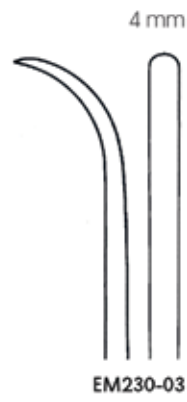

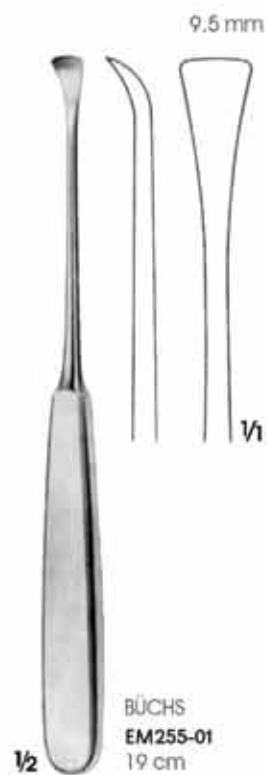
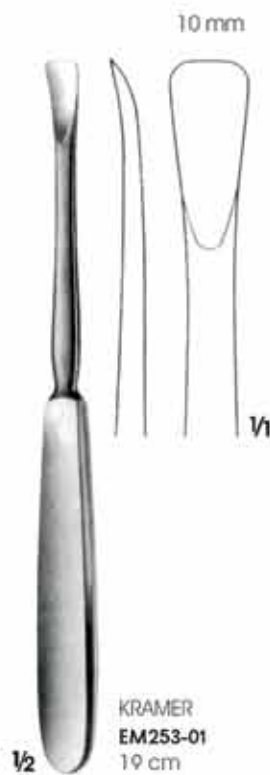
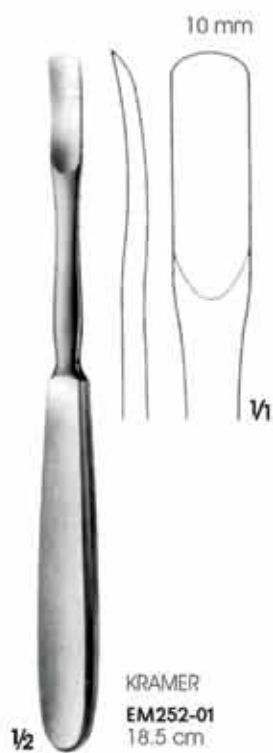
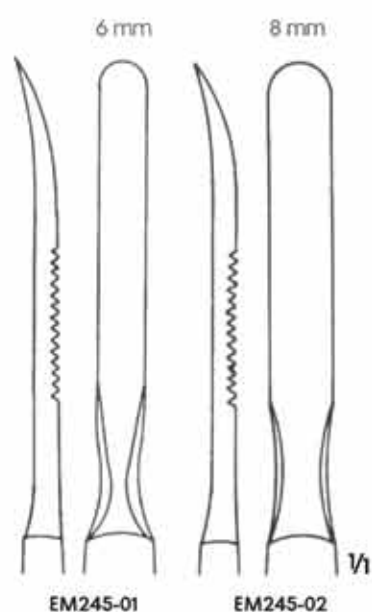
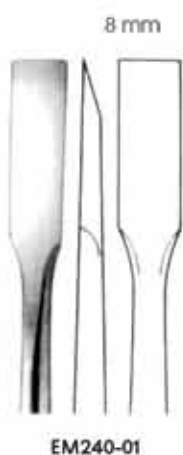
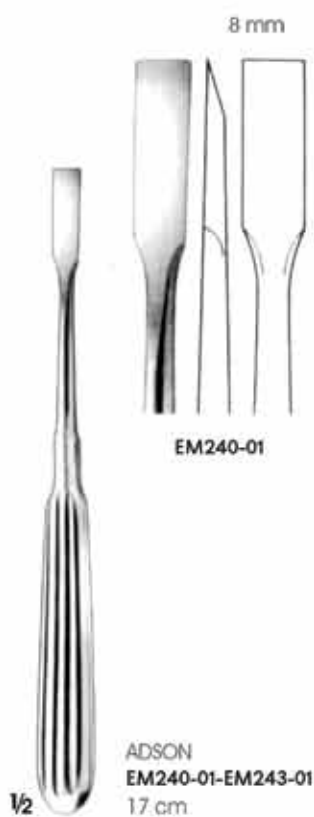



MC KISSOCK
EM258-00
Künt/Blunt
19.5 cm

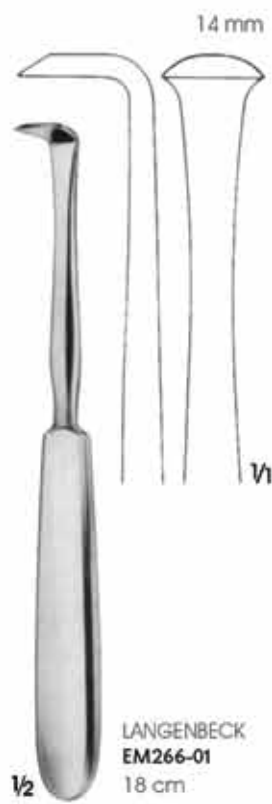

LANGENBECK
EM266-01
18 cm



SCHNEIDER
EM270-01
17.5 cm

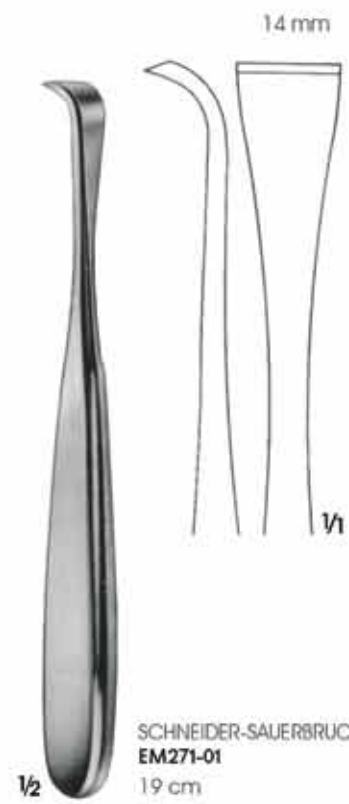

SCHNEIDER-SAUERBRUCH
EM271-01
19 cm



SEDILLOT
EM275-01
18.5 cm

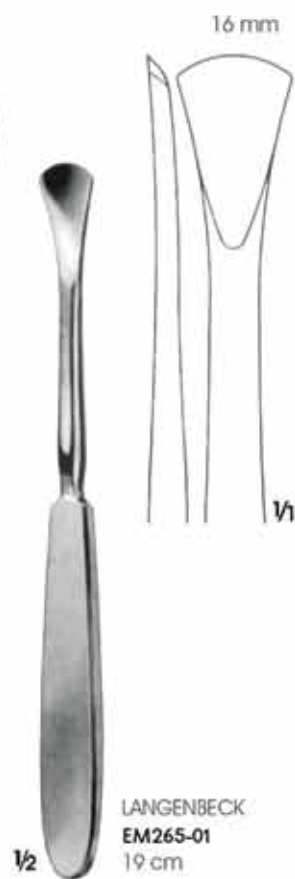

LANGENBECK
EM265-01
19 cm

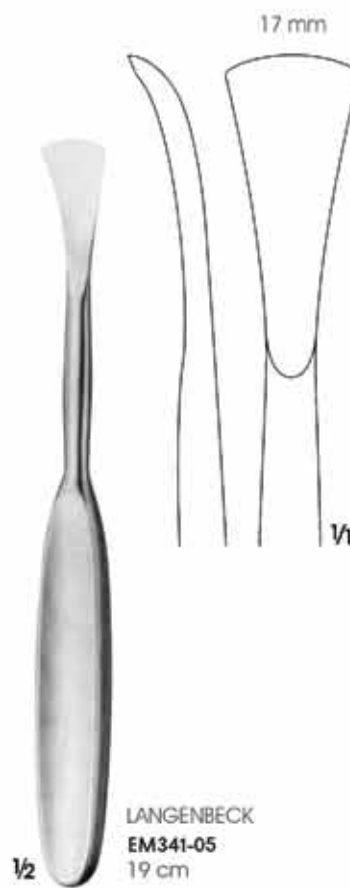

LANGENBECK
EM341-05
19 cm

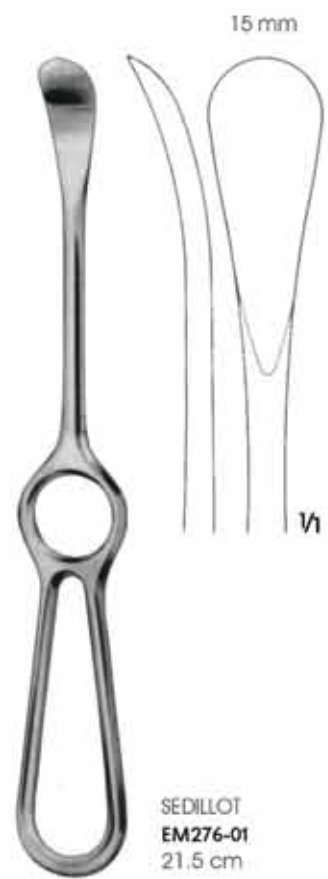

SEDILLOT
EM276-01
21.5 cm



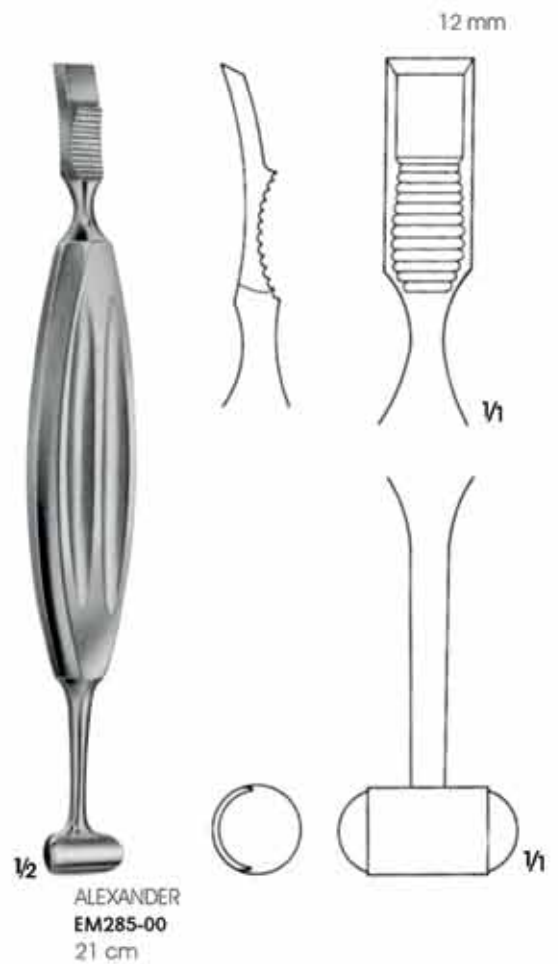
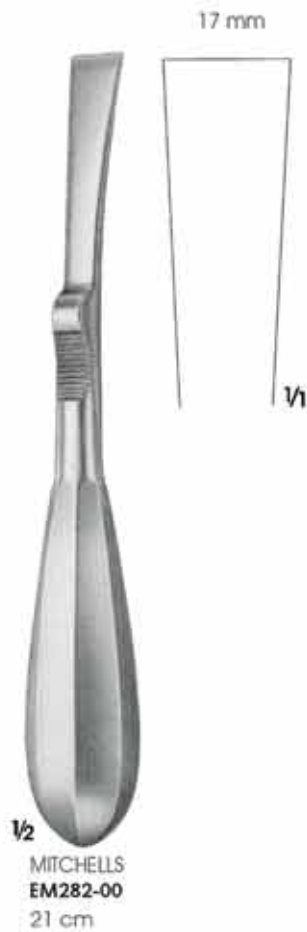
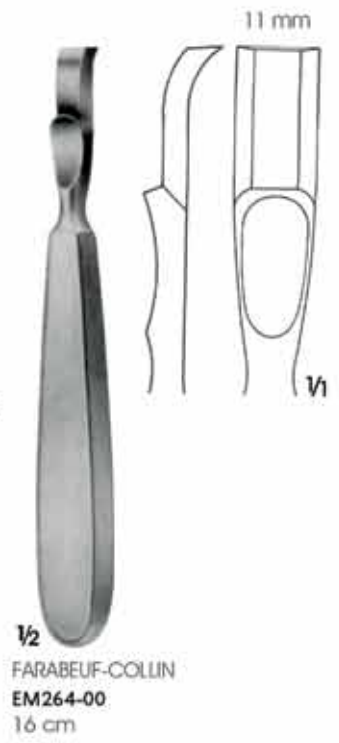
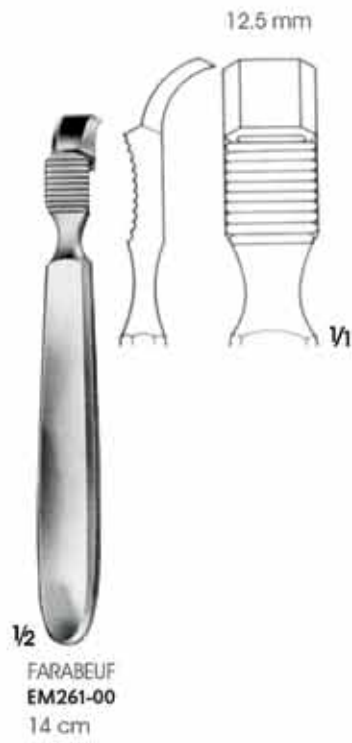
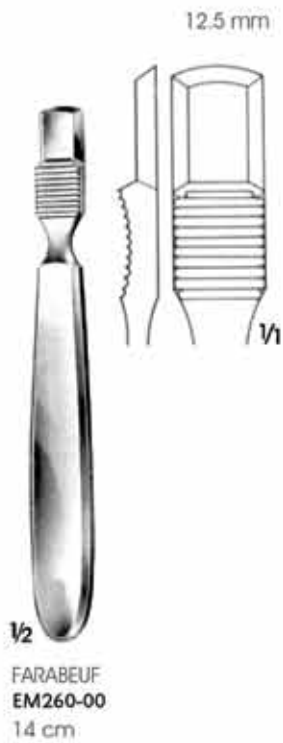

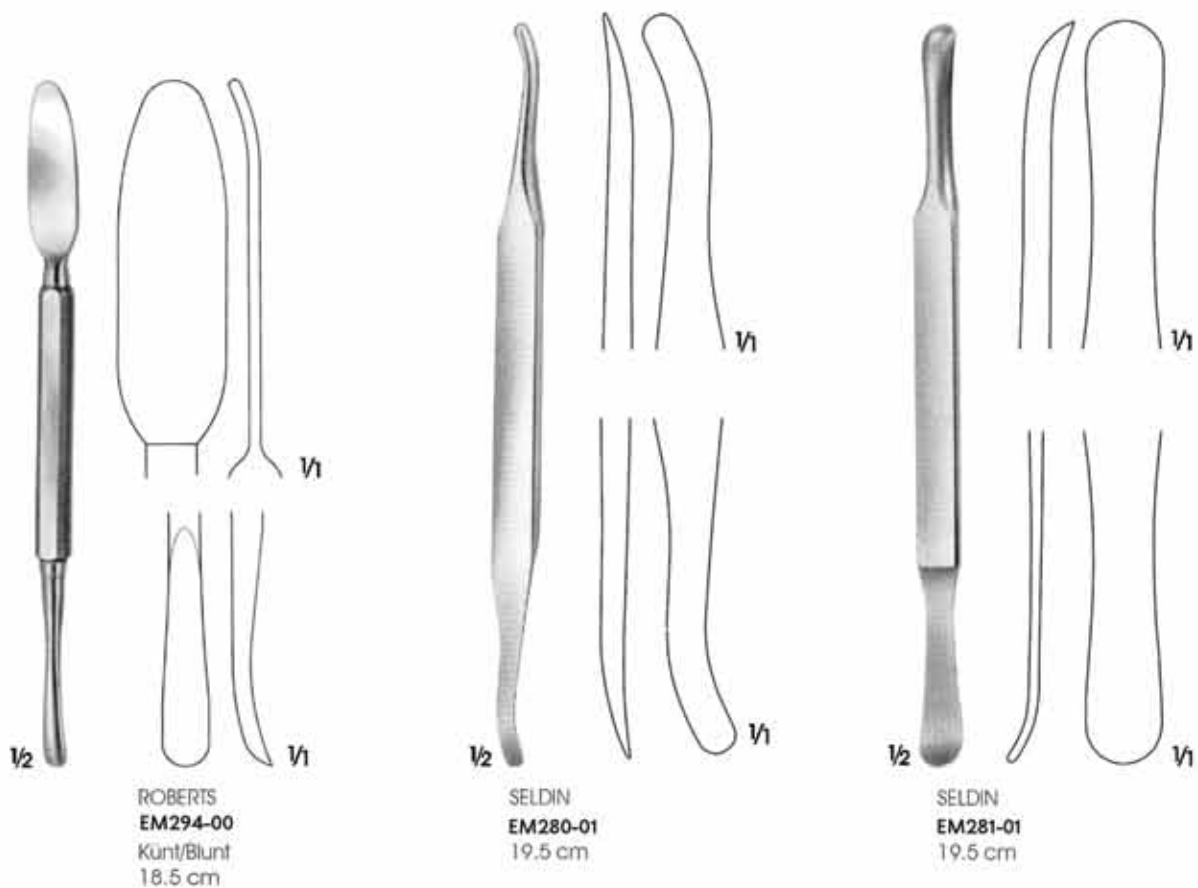
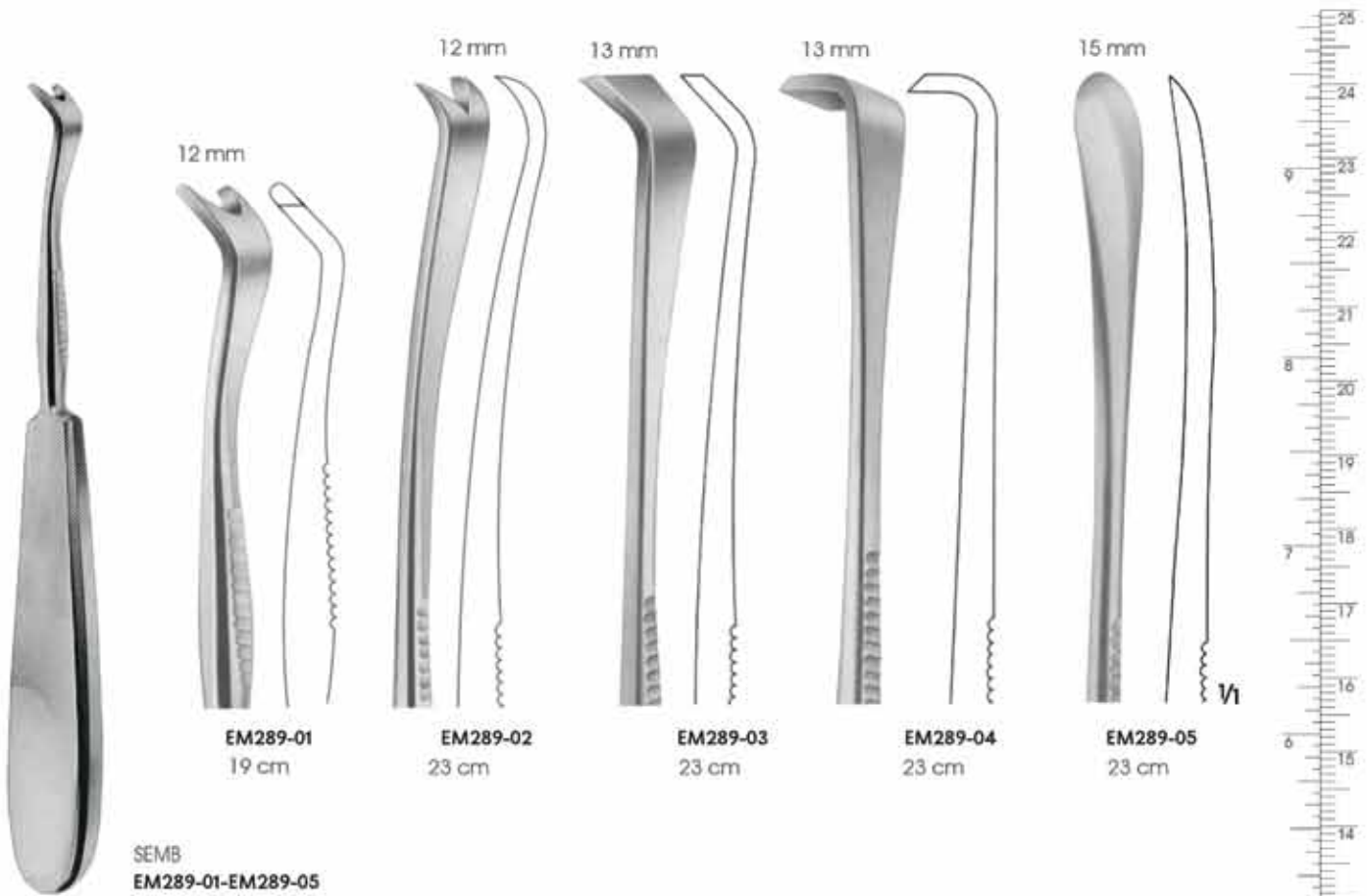

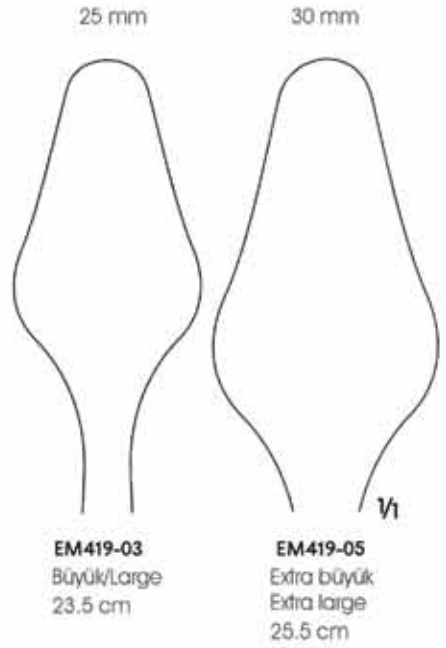
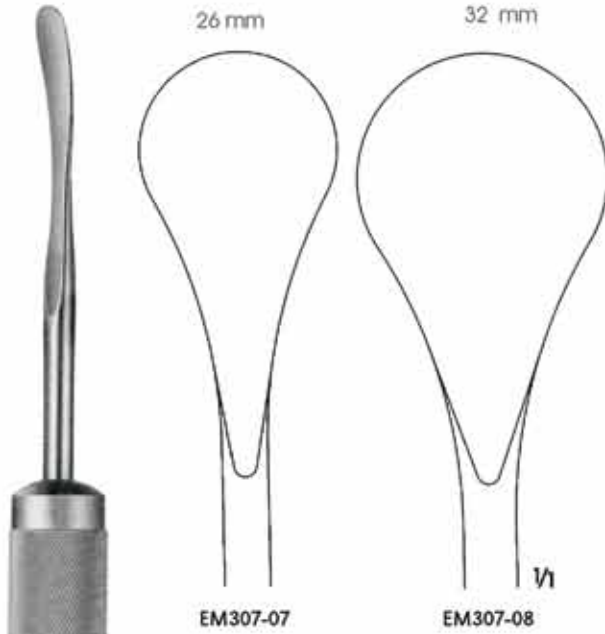
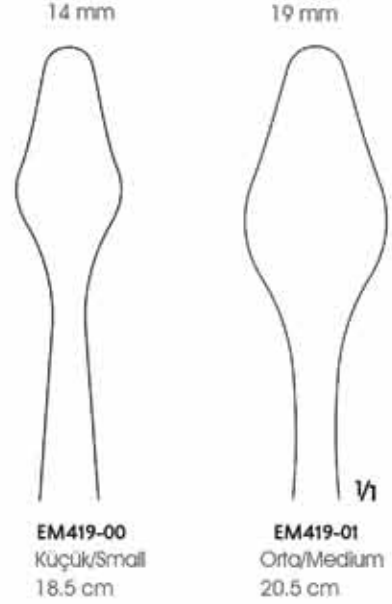
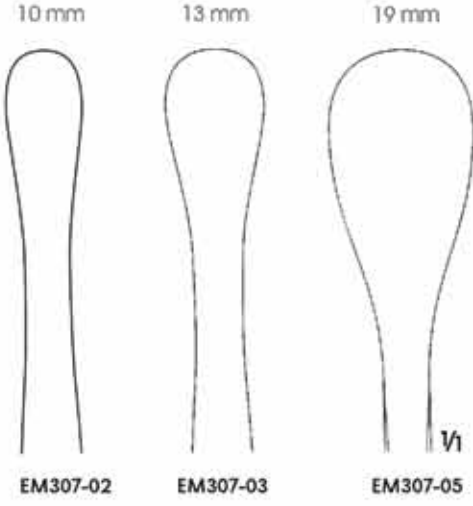

COBB
EM307-02-EM307-08
Raspa/Raspatory
28 cm



CHANDLER
EM419-00-EM419-05
Elevatör/Elevators



KEY
EM300-02-EM300-14

	Genişlik Wid th	Boy Uzunluk
EM300-11	6 mm	18 cm
EM300-05	10 mm	19 cm
EM300-02	13 mm	19 cm
EM300-13	19 mm	20 cm
EM300-14	25 mm	21 cm



EM305-03



EM305-02



EM305-01



1/2
COBB
EM305-01-EM305-03
24 cm



EM306-03



EM306-02



EM306-01



1/2
COBB
EM306-01-EM306-03
27 cm



143° buhar sterilizörlerinde steril edilebilir.
Can be sterilized in a steam sterilizer up to 143°

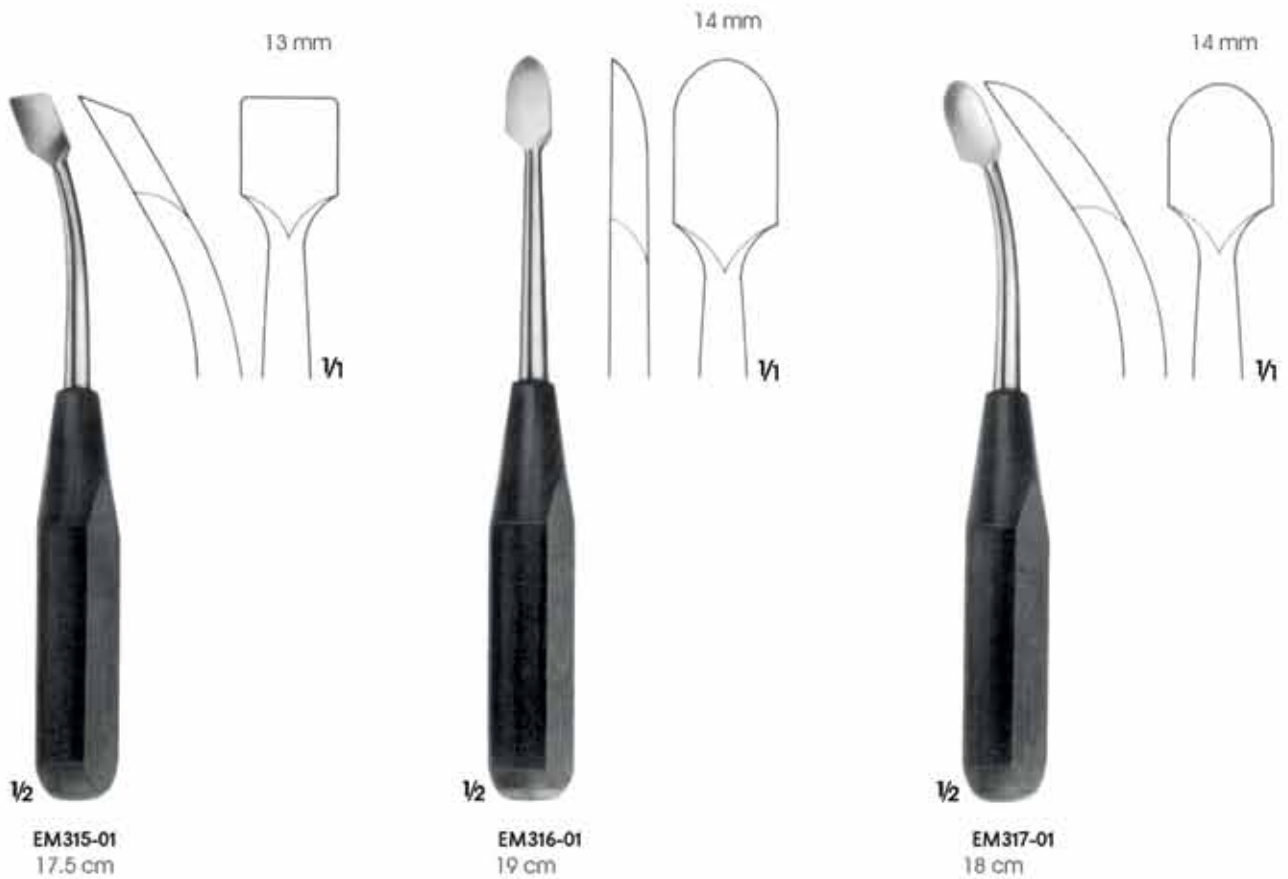
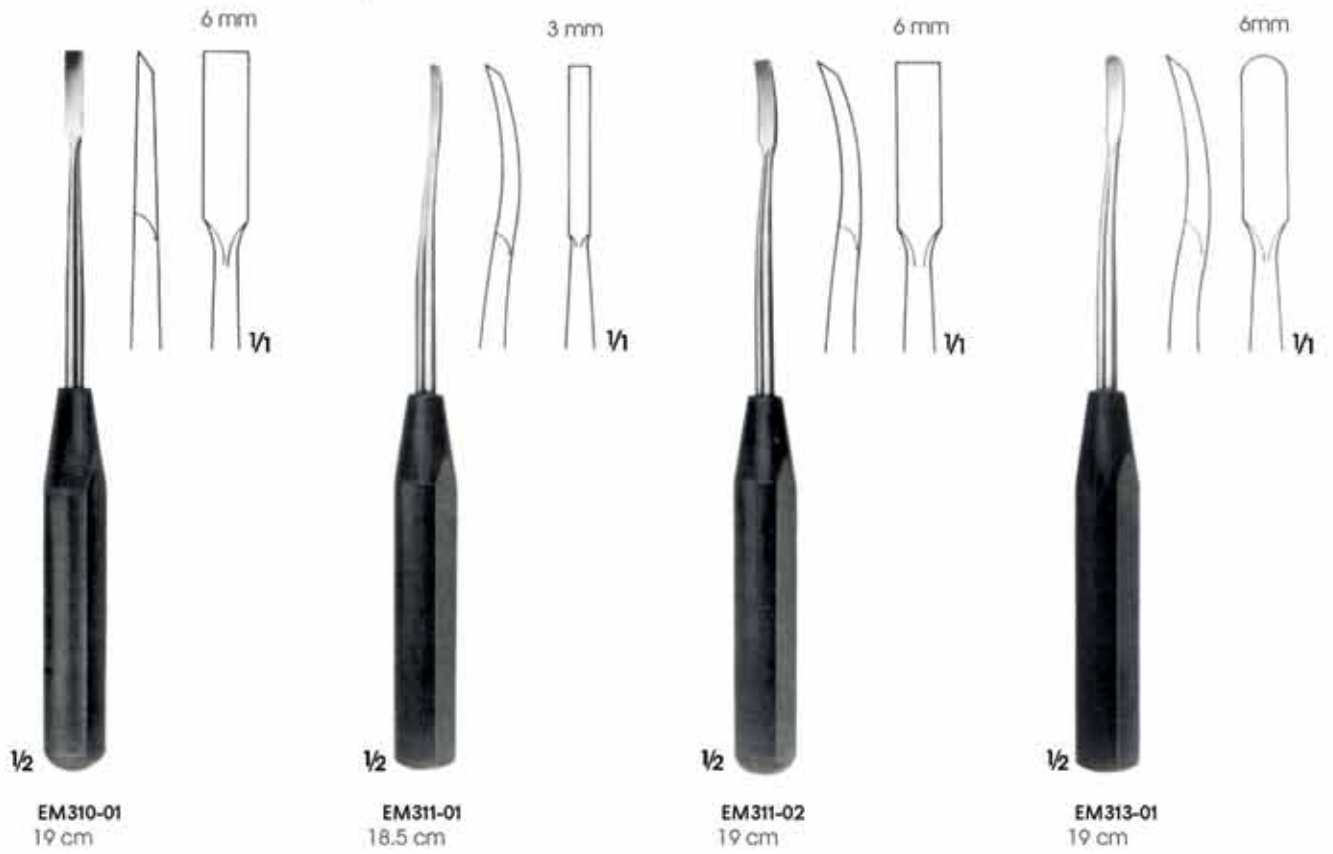

143° buhar sterilizatörlerinde steril edilebilir.
Can be sterilized in a steam sterilizer up to 143°

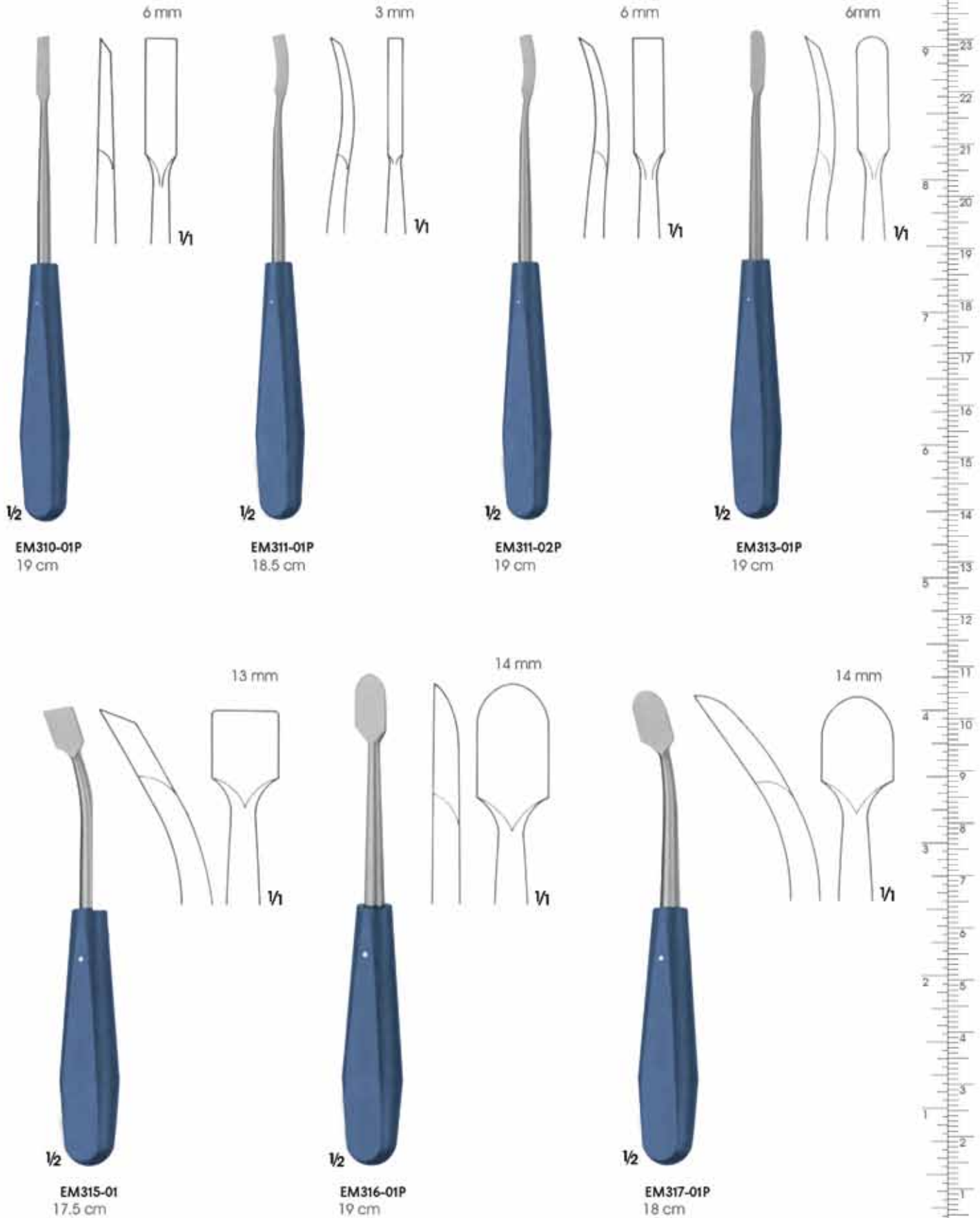



DOYEN
EM290-01-EM291-01
Çocuklar için/For children
17.5 cm

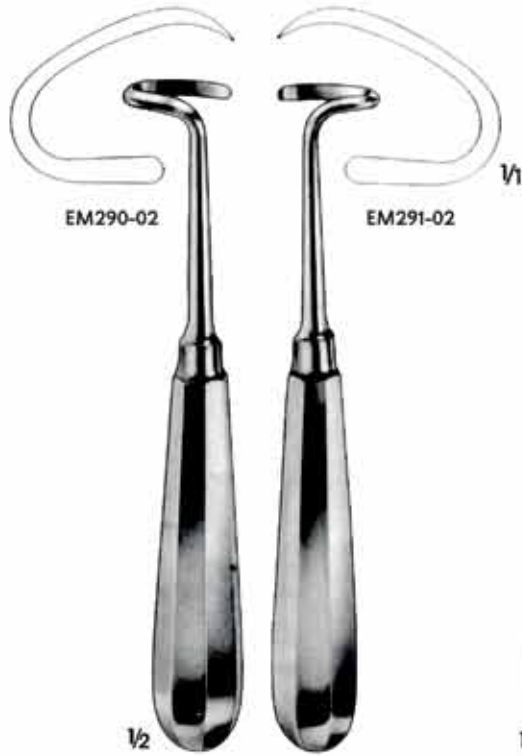

DOYEN
EM290-02-EM291-02
Yetişkinler için/For adults
17.5 cm

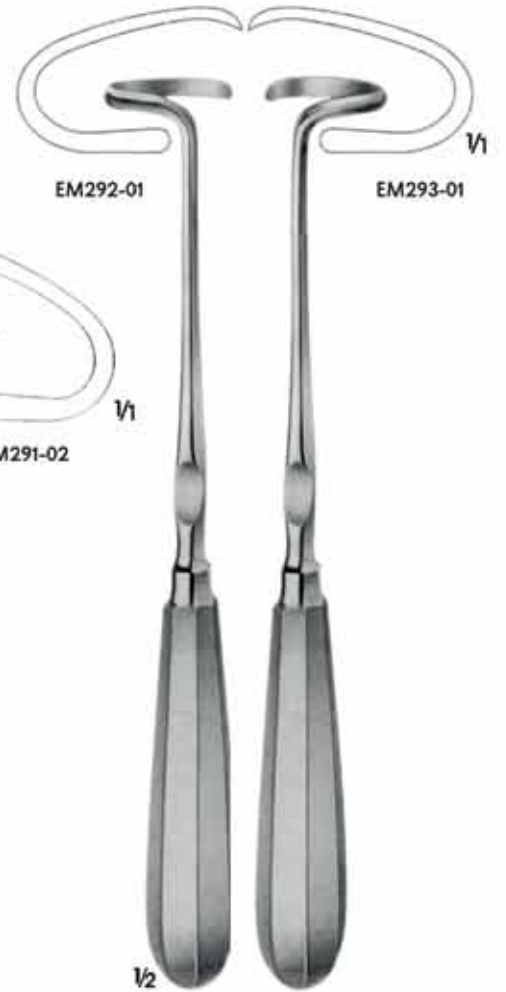

DOYEN
EM292-01-EM293-01
24 cm

143° buhar sterilizatörlerin de steril edilebilir.
Can be sterilized in a steam sterilizer up to 143°

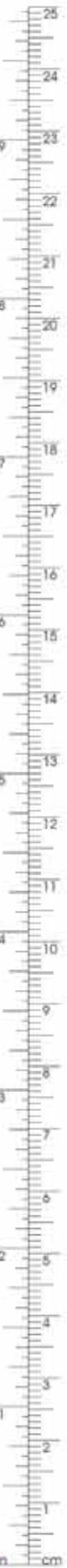

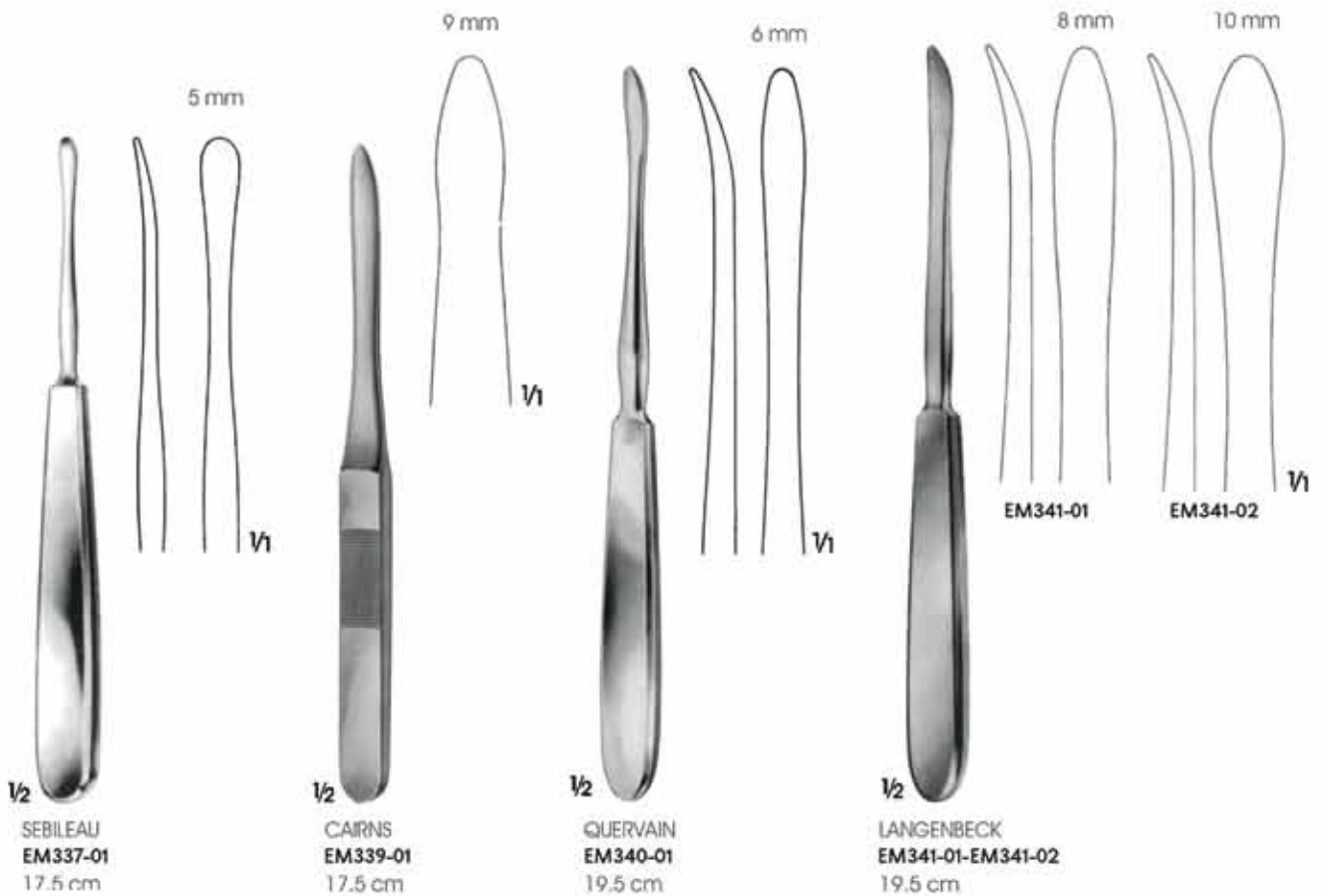
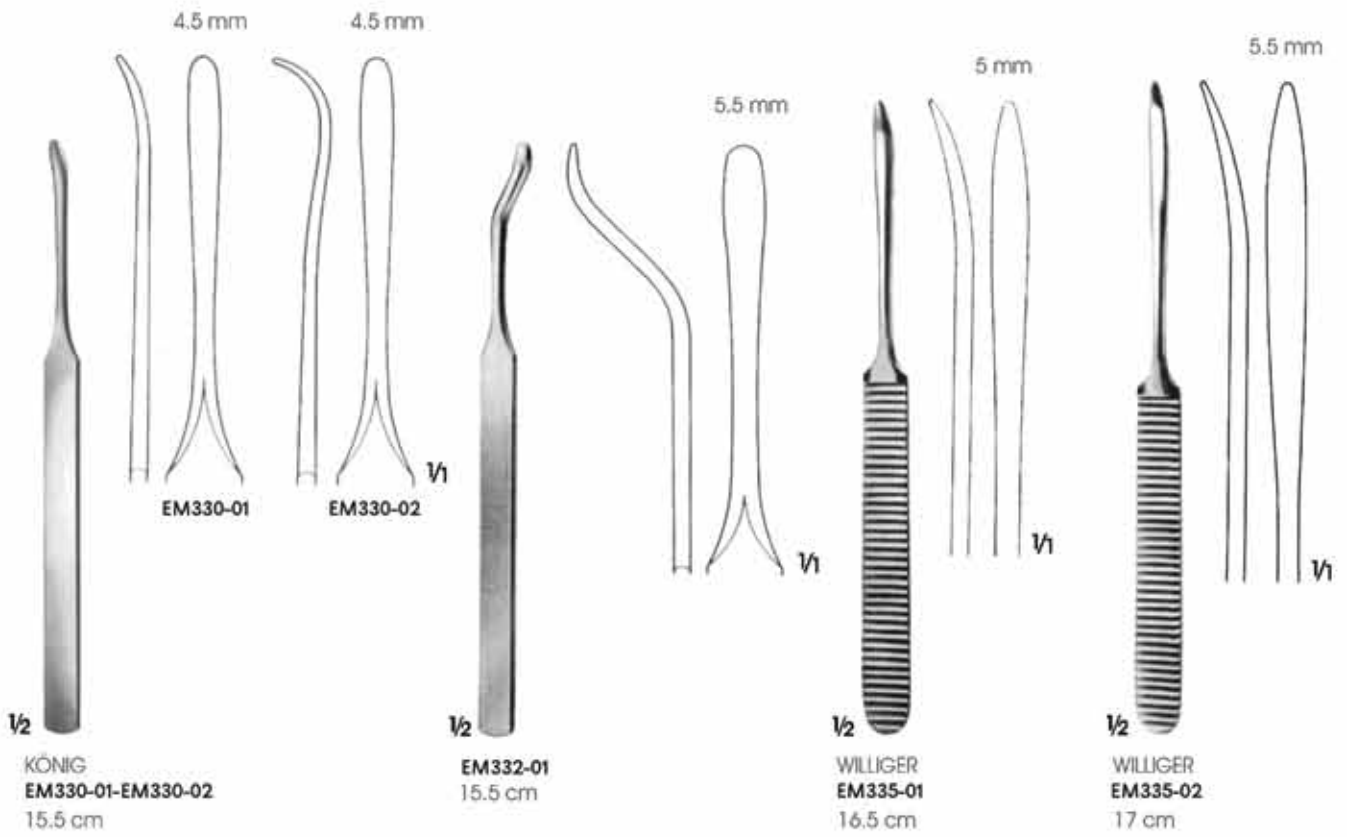

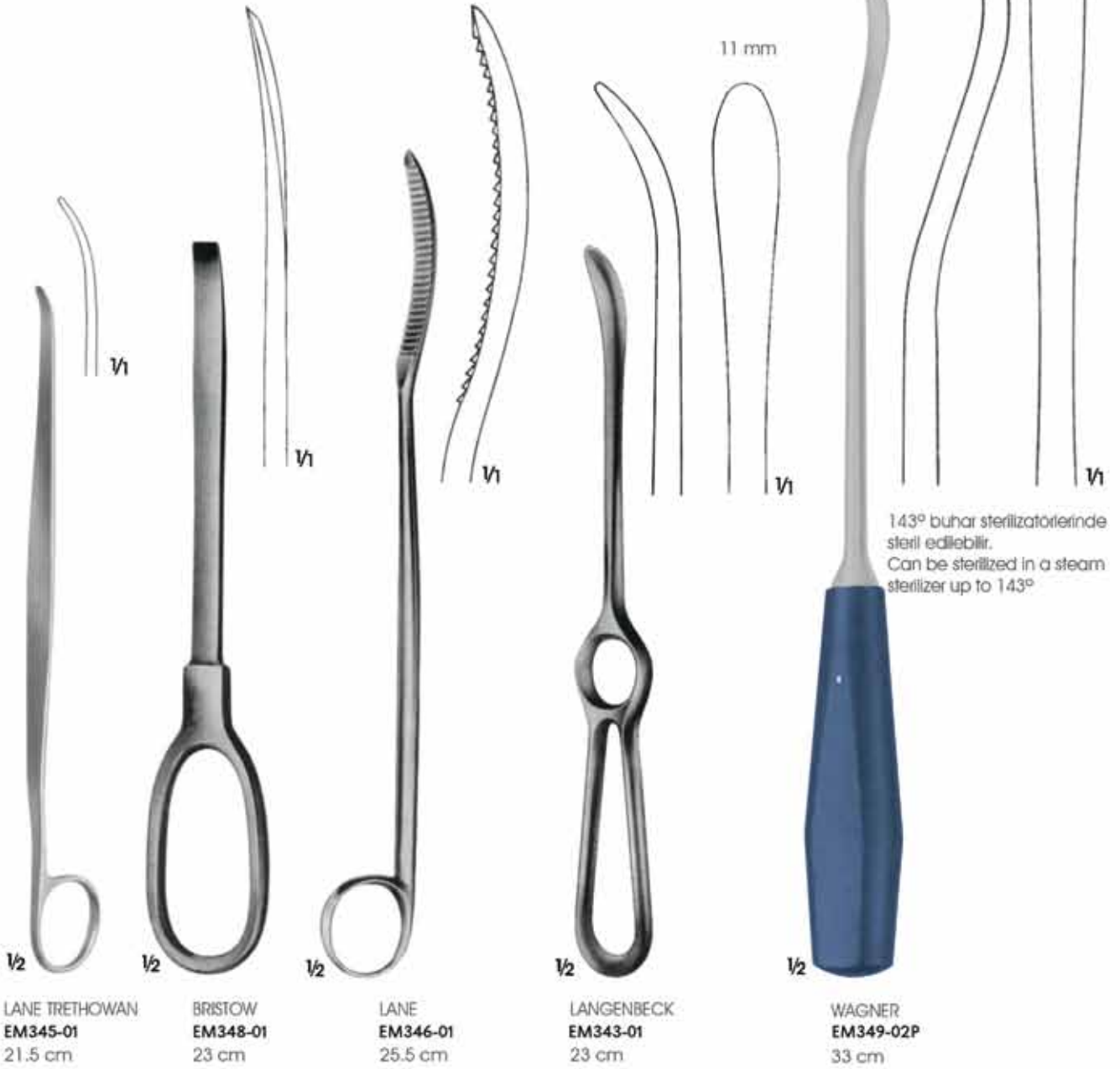

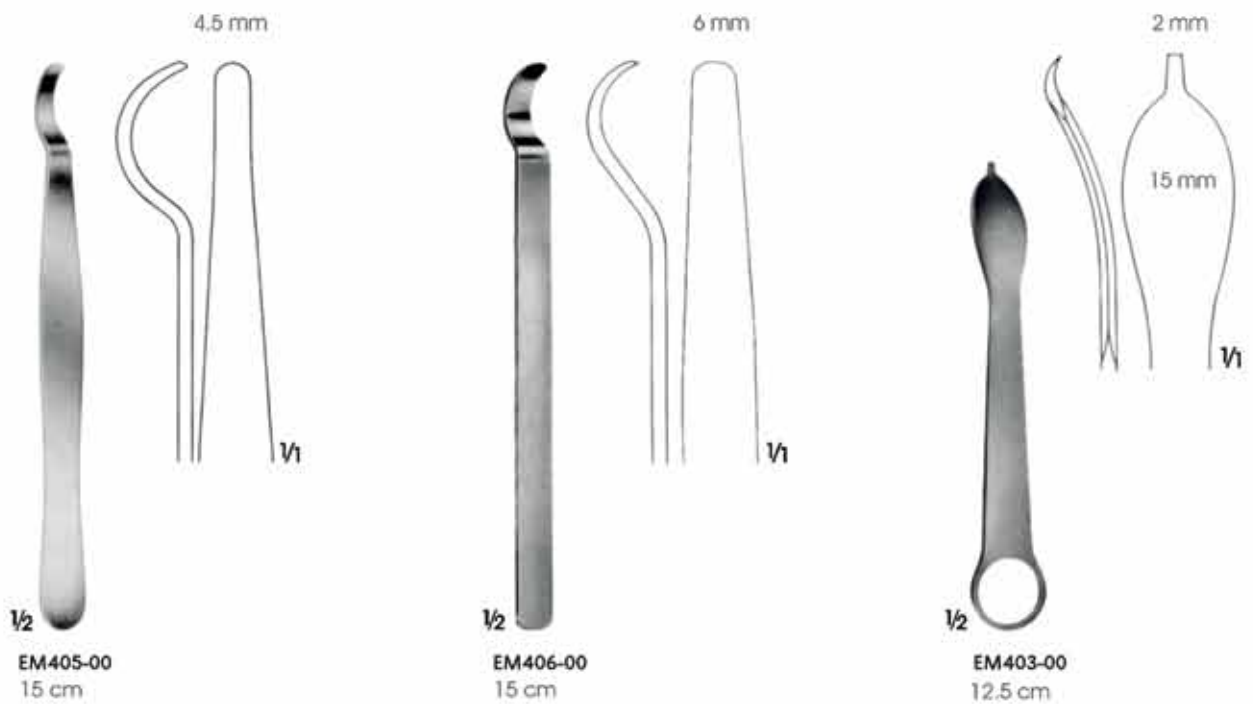
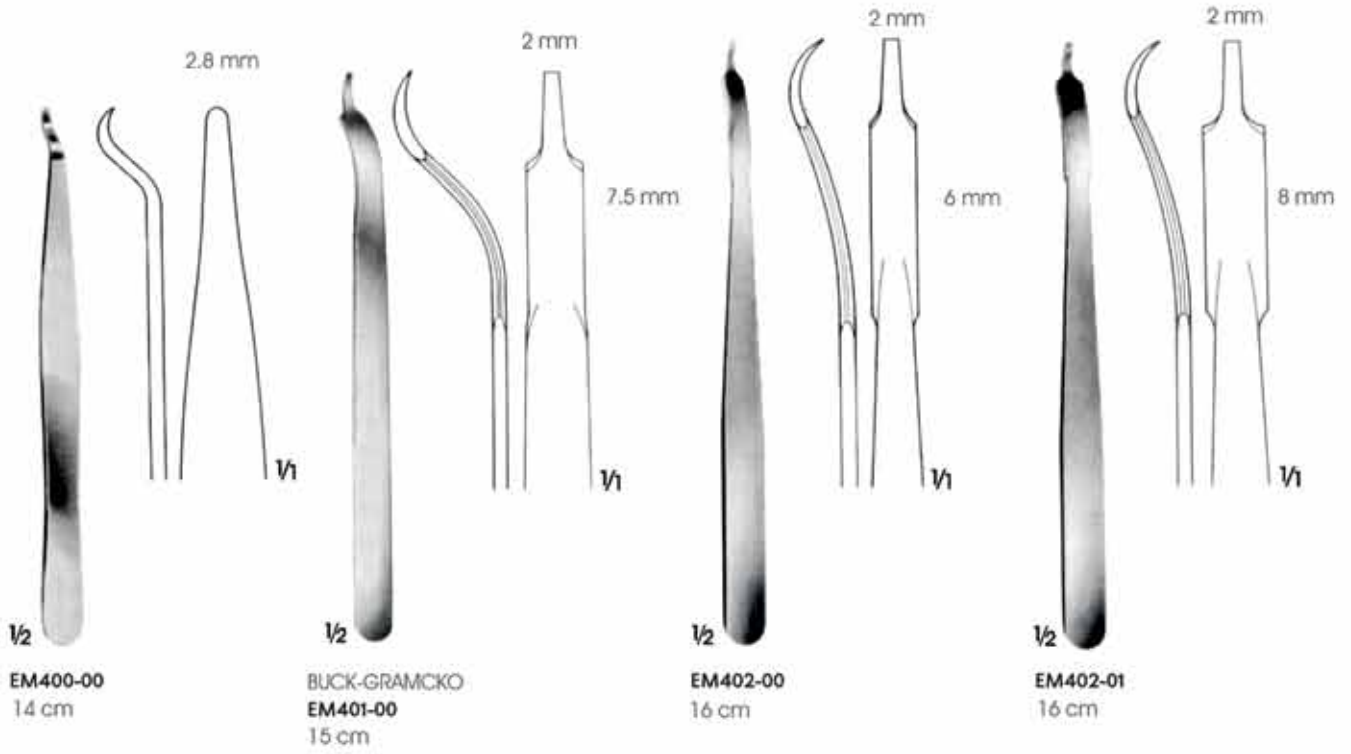

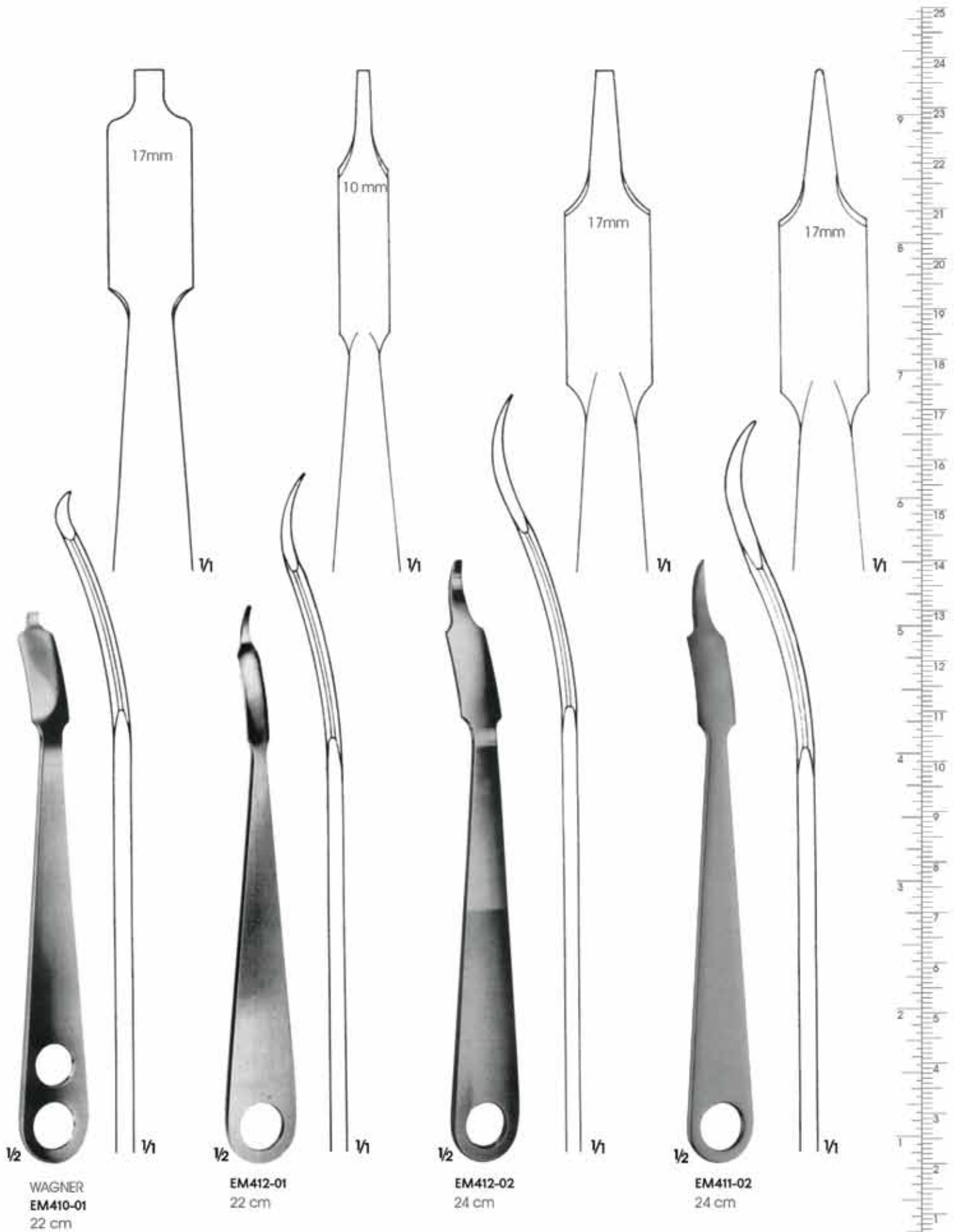



1/2
VATSON-JONES
EM407-01
28 cm

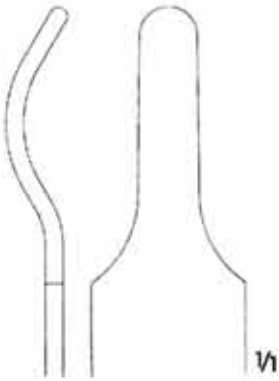

1/1

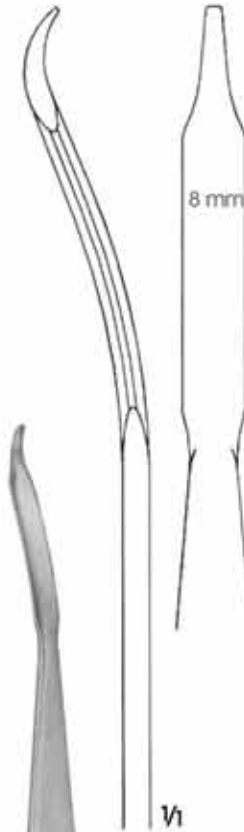

1/2
EM408-01
22 cm



1/1

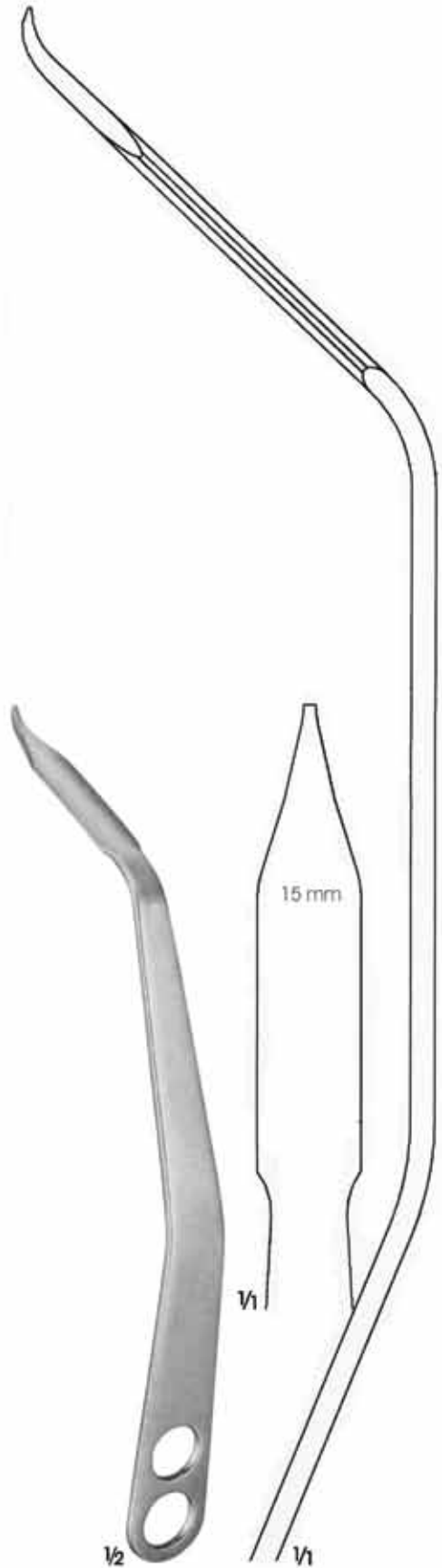

1/2
EM426-01
25 cm



1/1

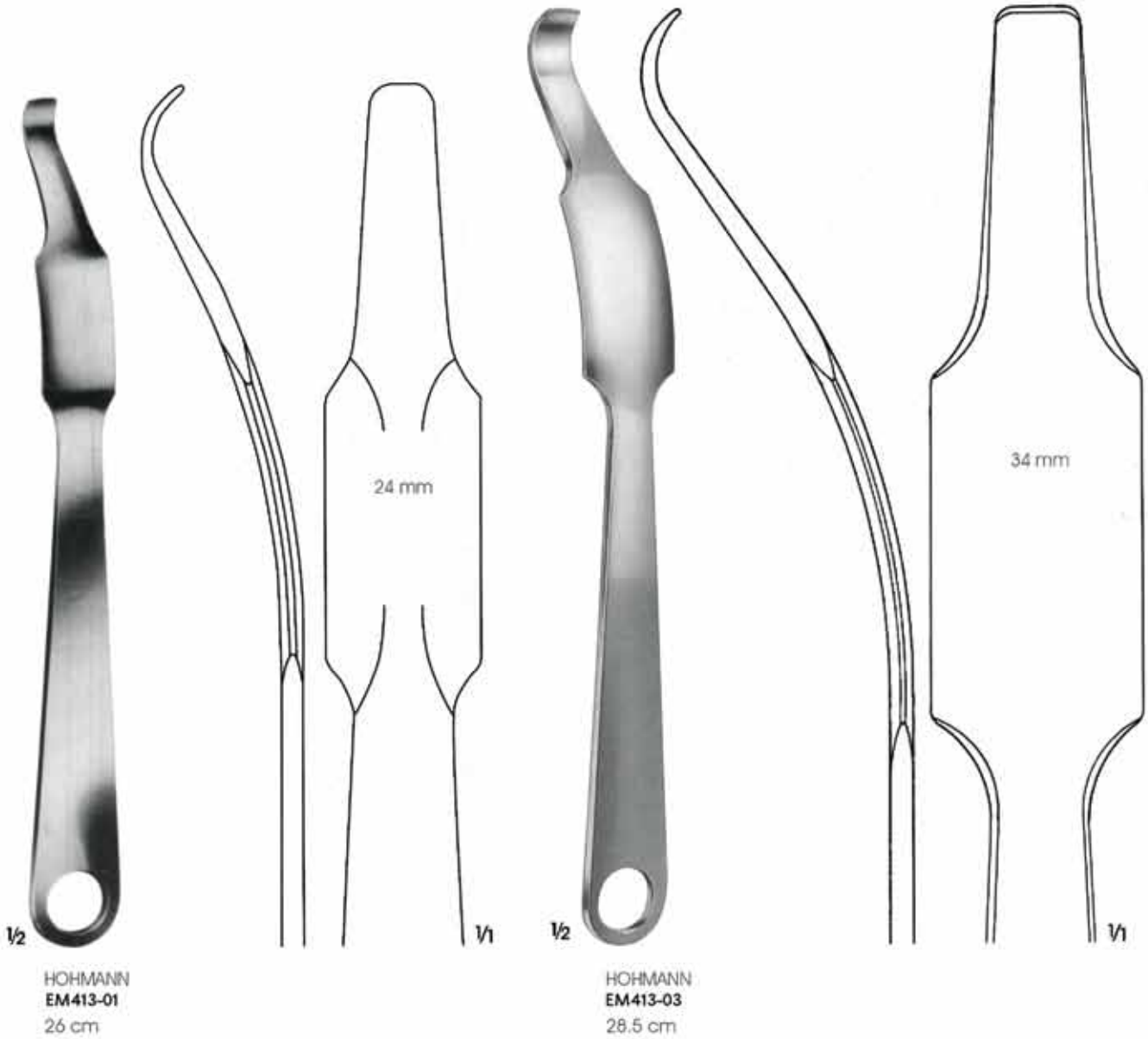

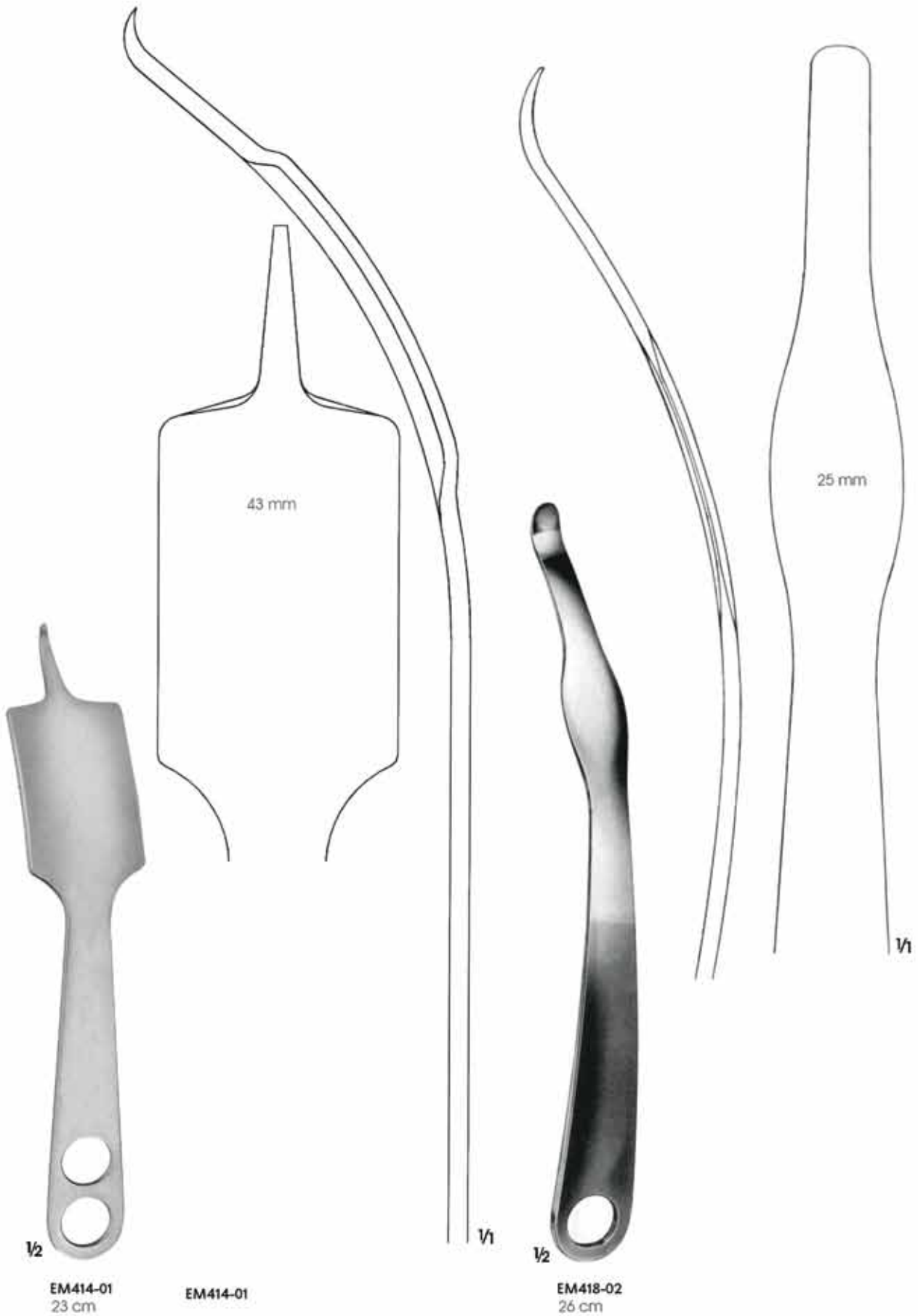

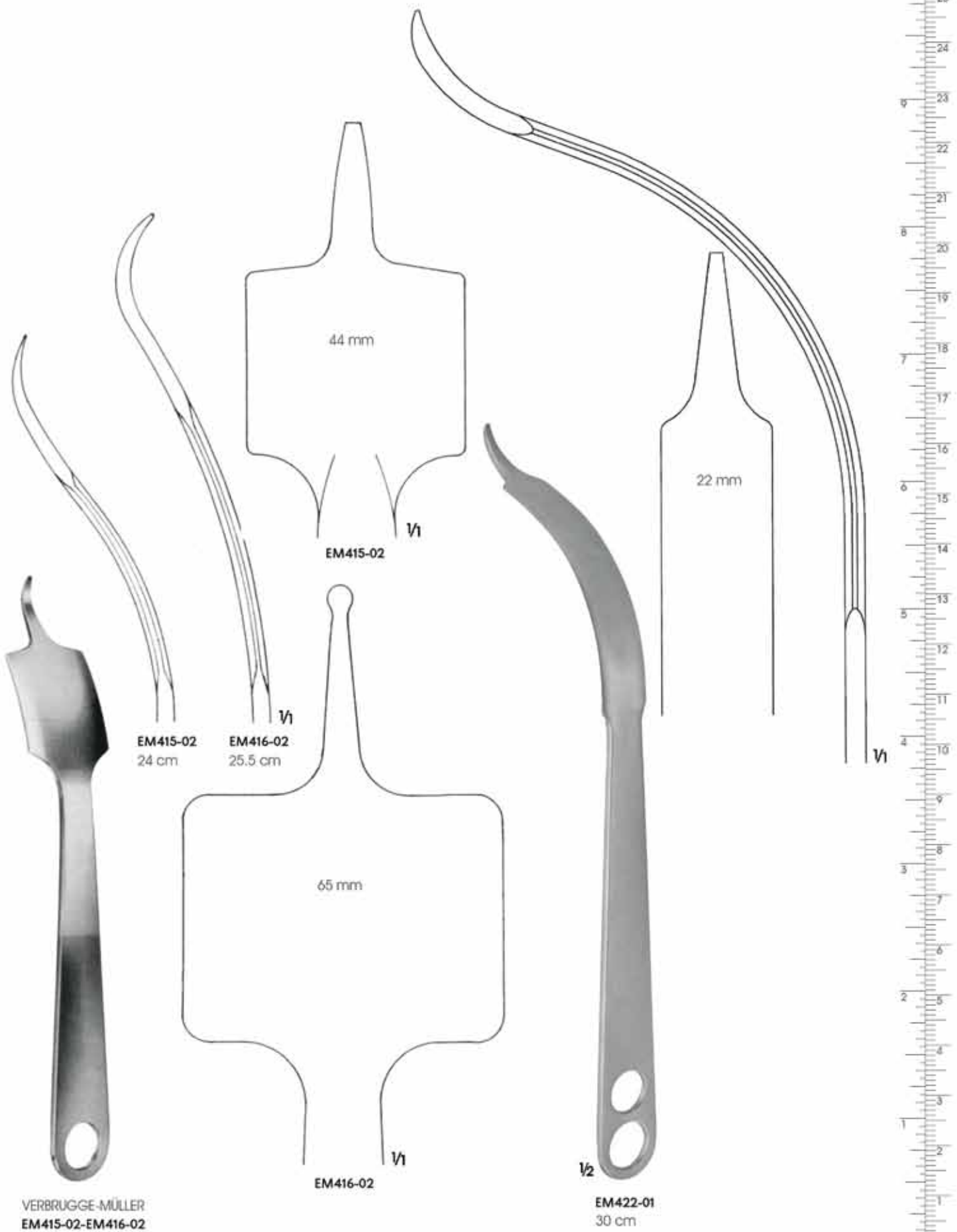

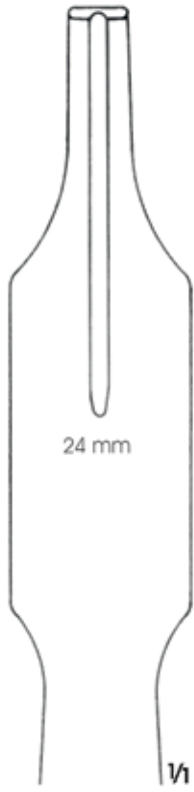

24 mm

1/1



1/2

LANGE-HOHMANN
EM420-02
25 cm



1/1



1/2

LANGE-HOHMANN
EM421-02 26.5 cm
EM421-03 28 cm

EM421-02
30 mm
EM421-03
33 mm

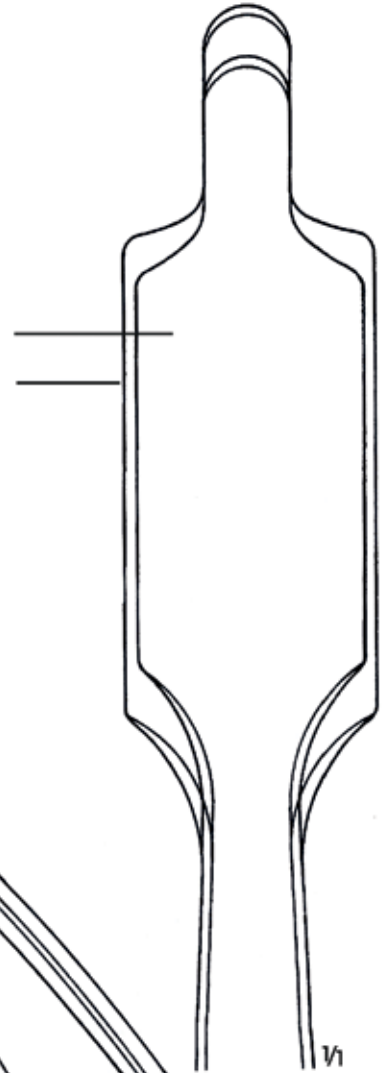

1/1

EM421-02

EM421-03

1/1

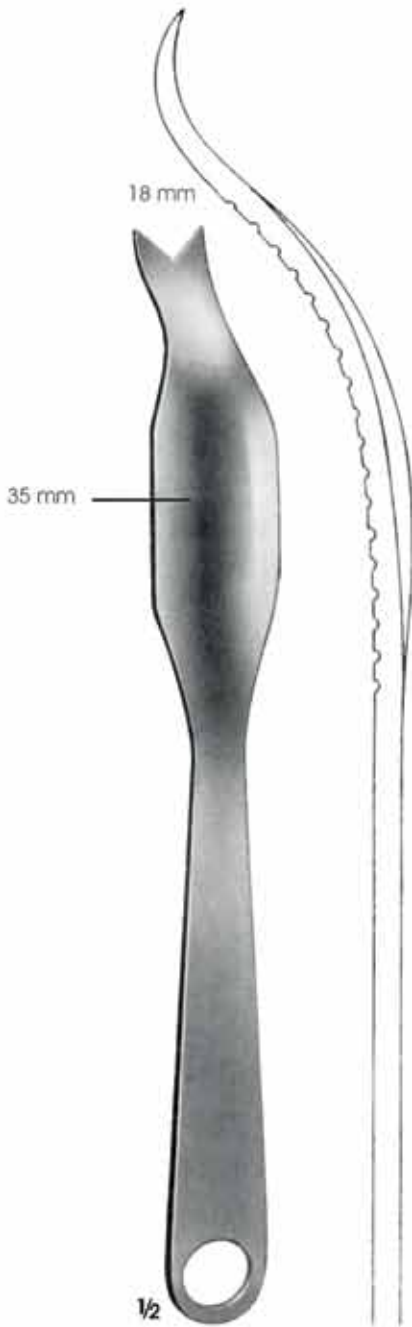

1/2

SCHUMACHER
EM423-02
29 cm

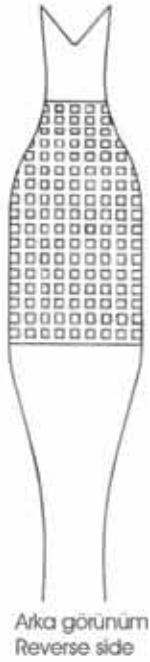

1/2

SCHUMACHER-WAGNER
EM424-02
35.5 cm

1/1



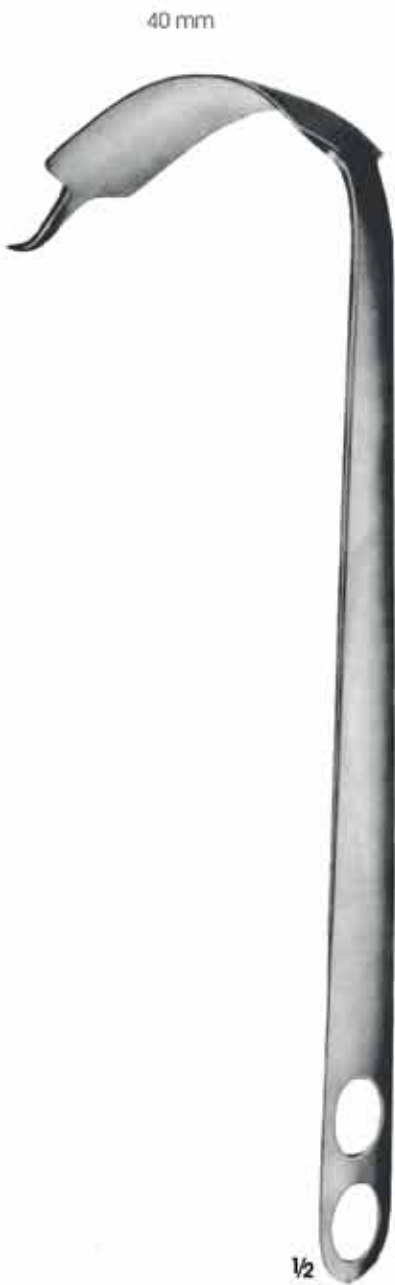

1/2
EM427-01
32 cm

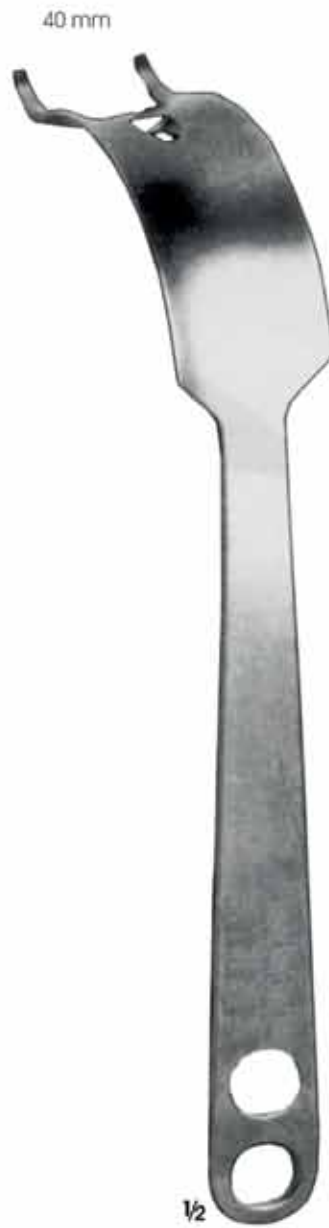

1/2
EM429-02
32 cm



1/2
EM434-01
Femur ekartörü
Femoral retractor
38 cm

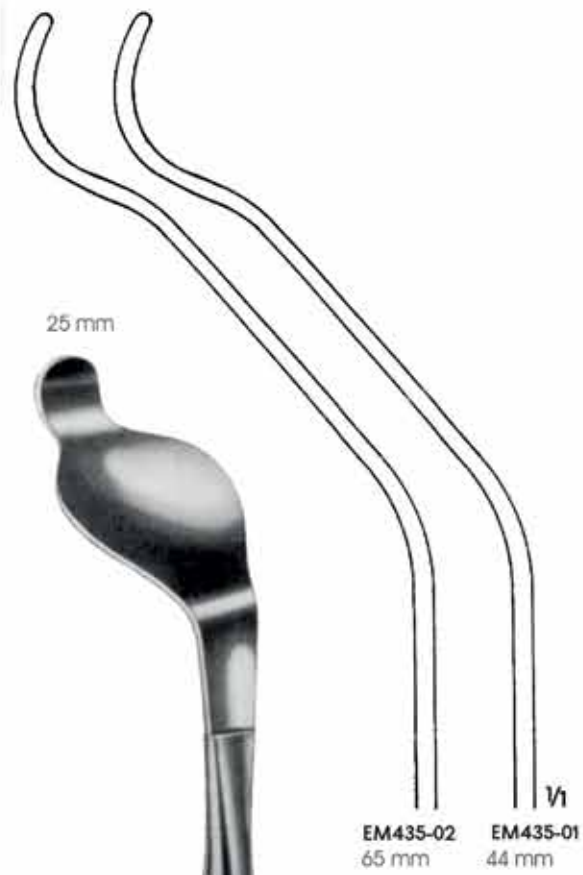

BENNETT
EM435-01 25 mm-44 mm
EM435-02 25 mm-65 mm
23.5 cm

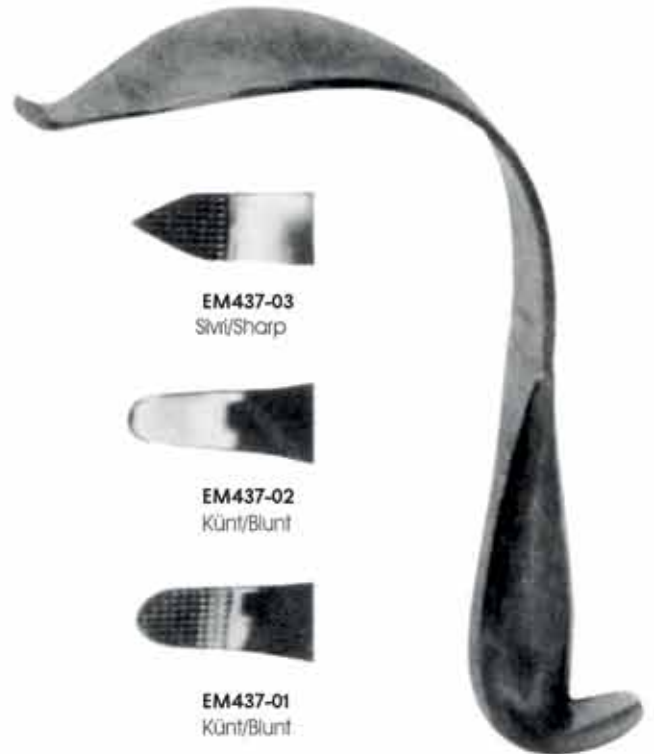

COBRA
EM437-01-EM437-03
28 cm





1/2
HOHMANN-ALDINGER
EM425-02
27 cm

1/2
EM428-02
29 cm

12 mm



TAGER
EM440-00
Mafsal elevatör
Bone lever for angle joint operations
17.5 cm



BLOUNT
EM431-02
27 cm

30 mm

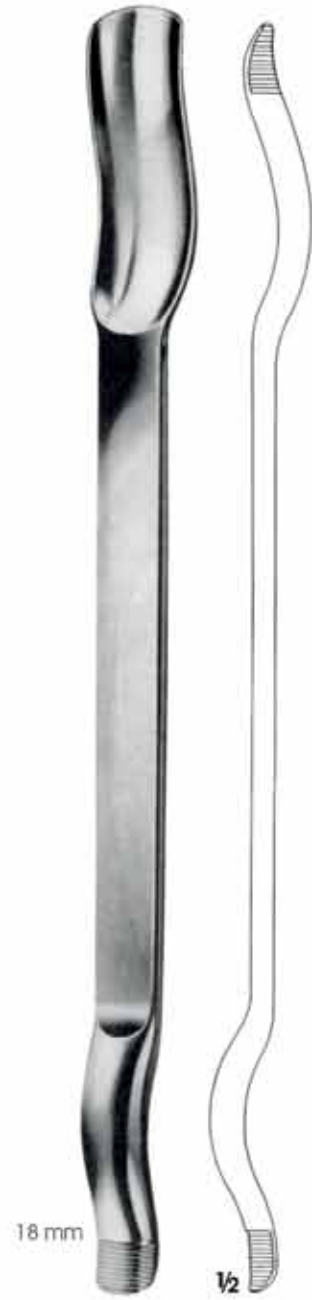

MURPHY-LANE
EM442-02
Lüksasyon elevatörü
Luxation lever
33 cm



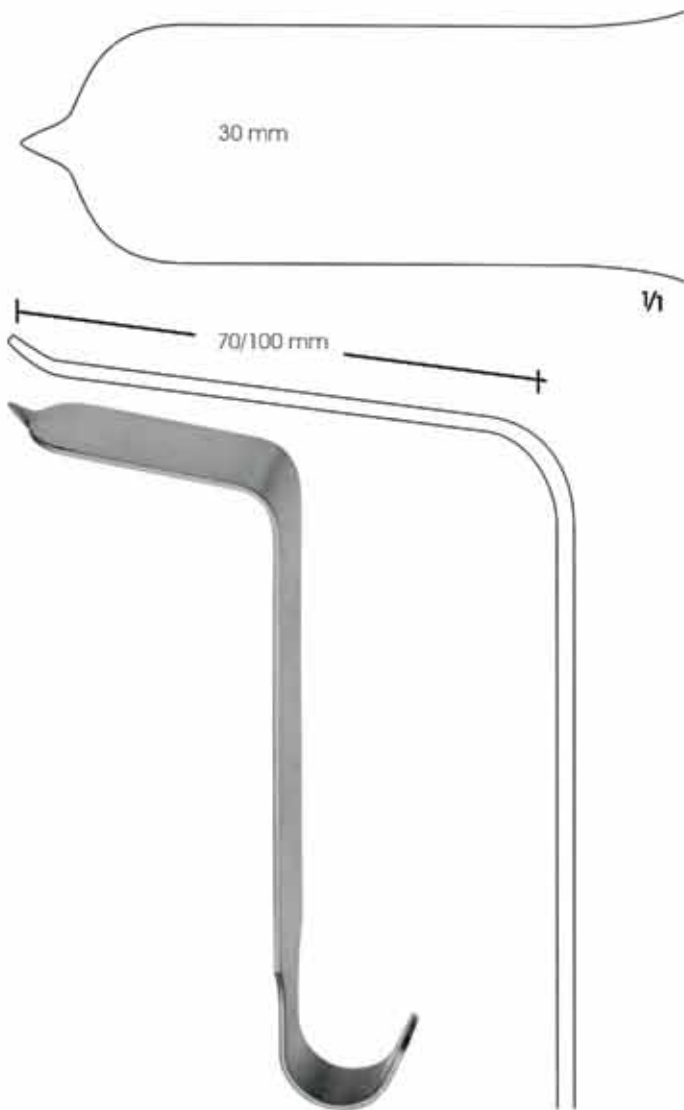

TAYLOR
EL482-00 30 x 70 mm
18.5 cm
EL482-01 30 x 100 mm
20 cm



EK335-02
25 x 75 mm

EK335-01
20 x 50 mm

EK335-00
13 x 25 mm

HIBBS
EK335-00-EK335-02
23.5 cm

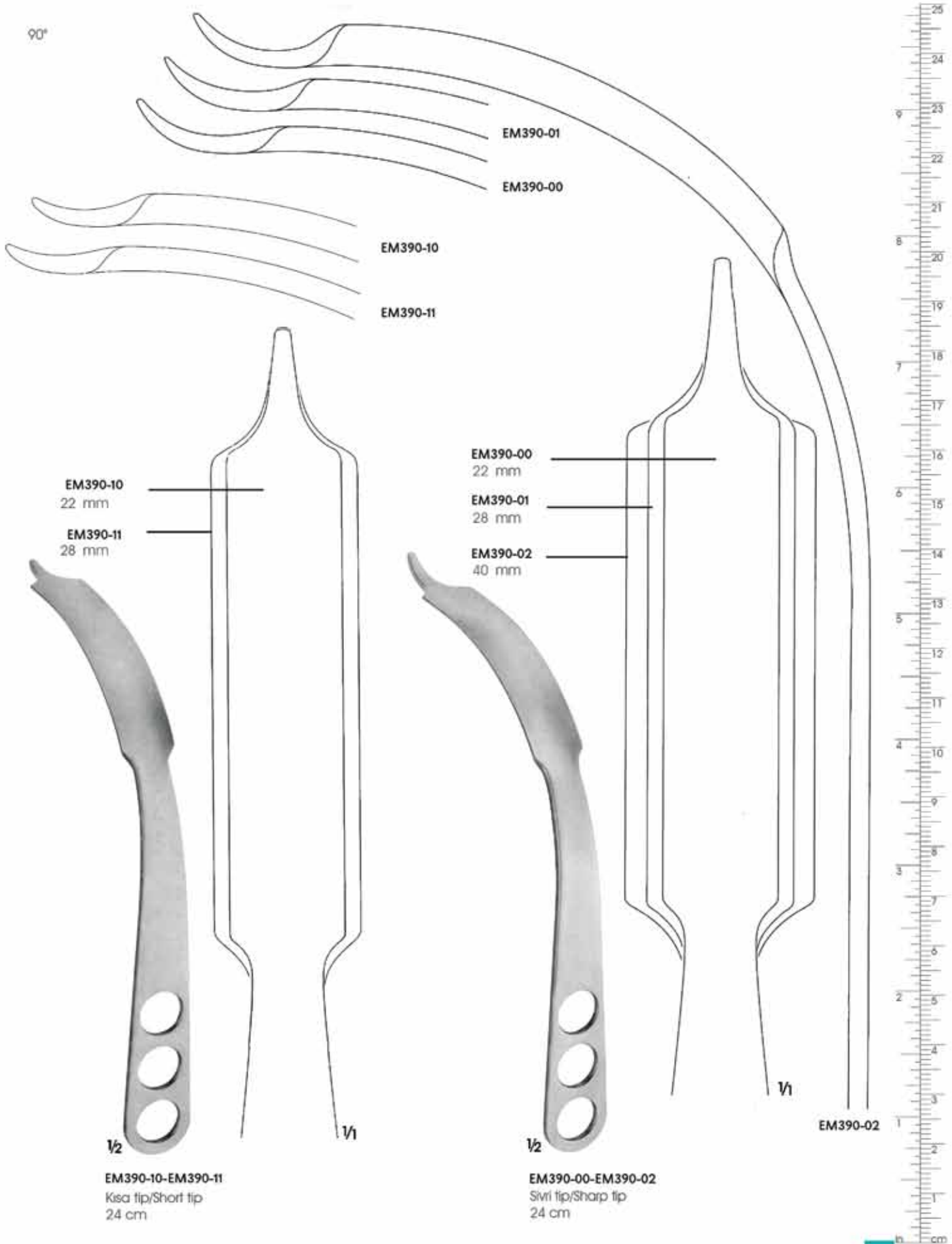

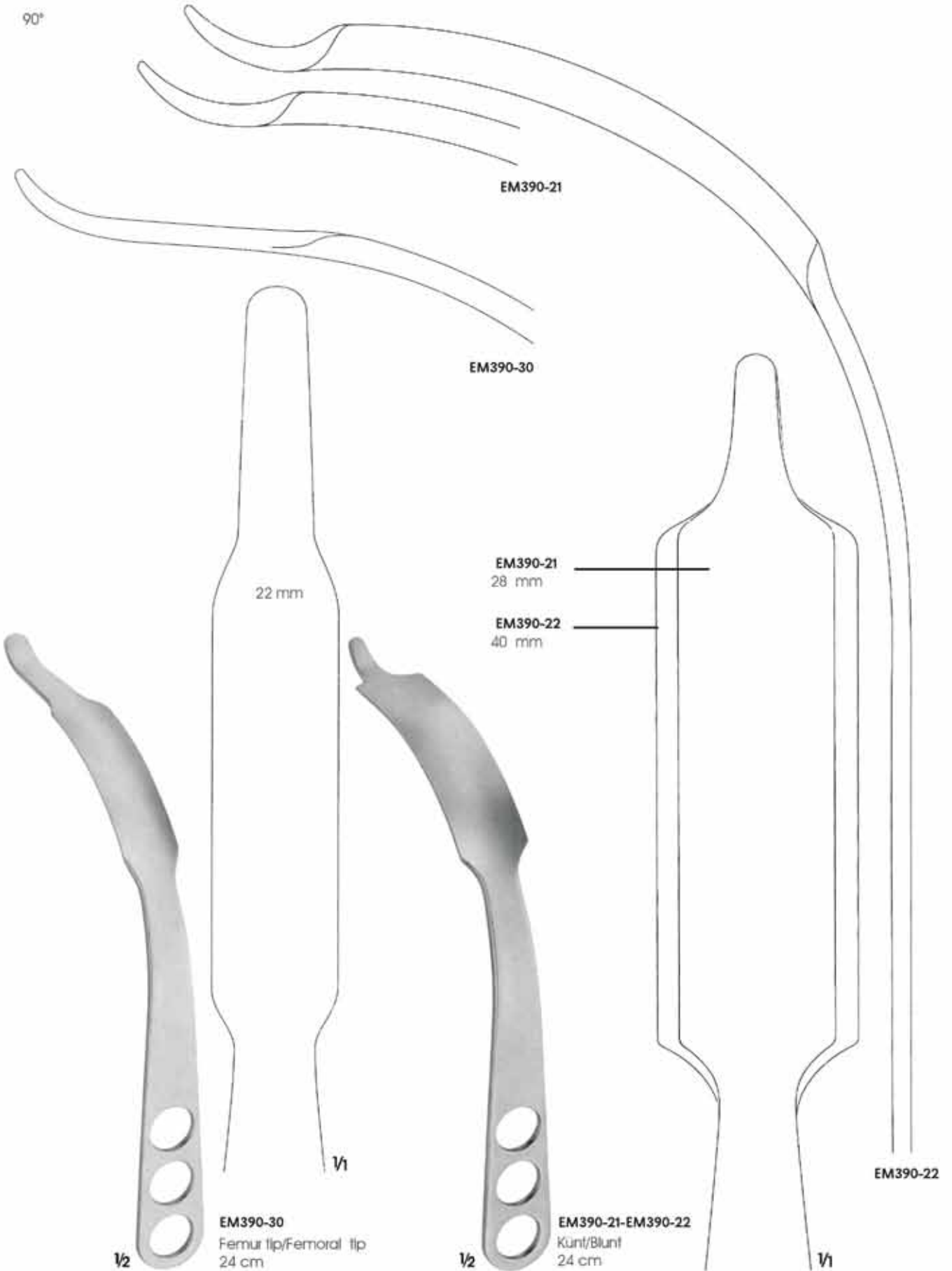

45°

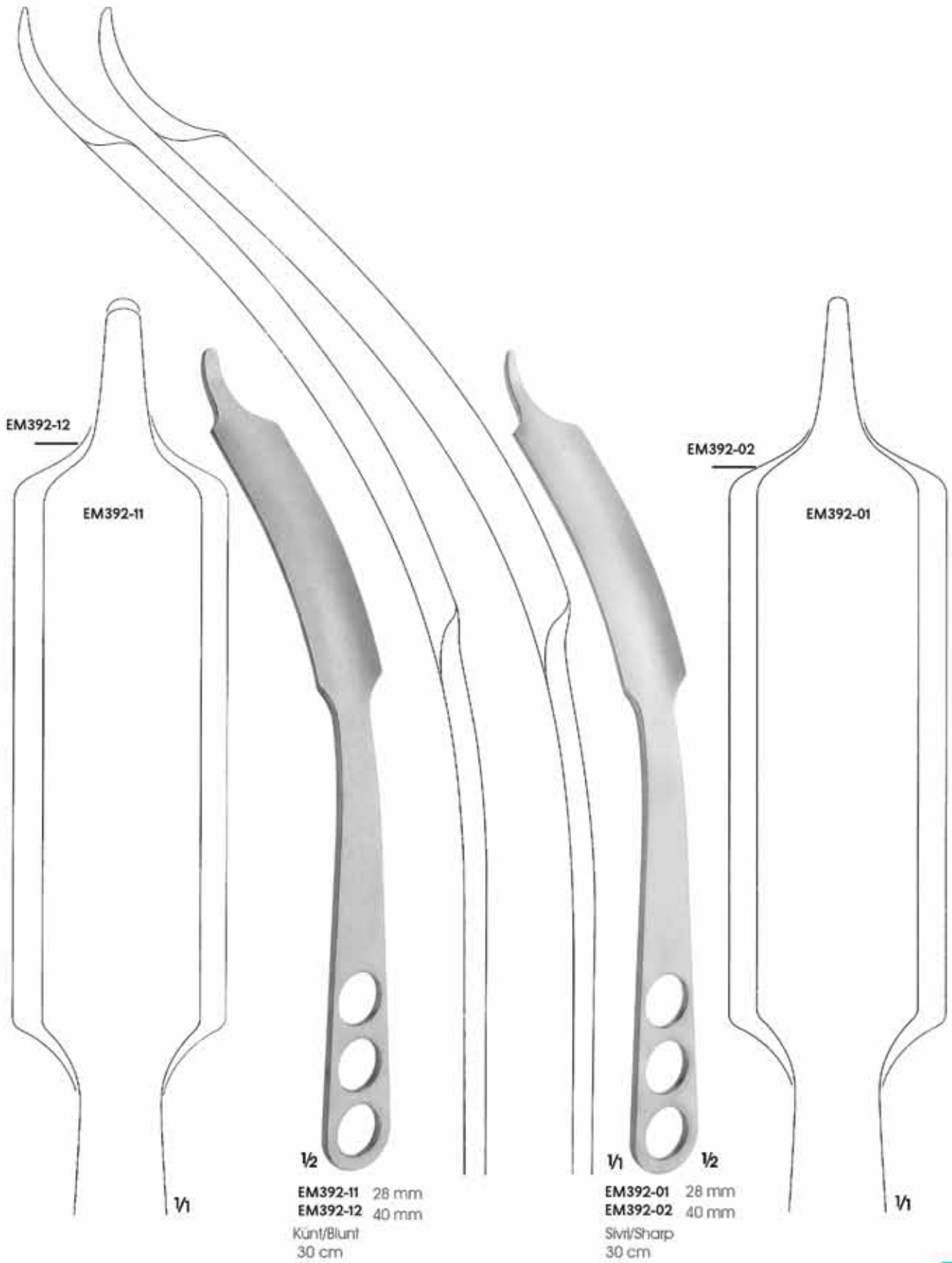

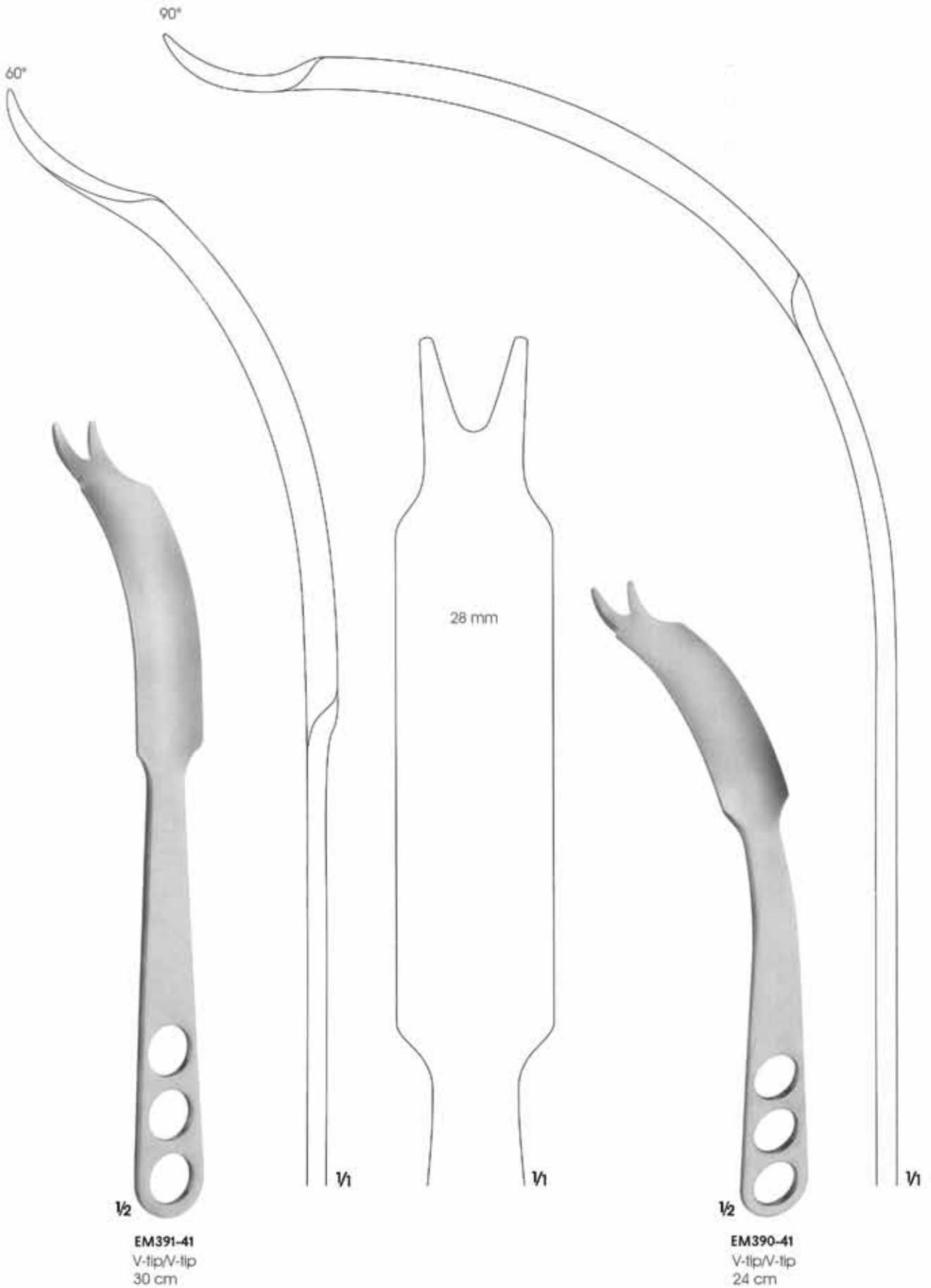

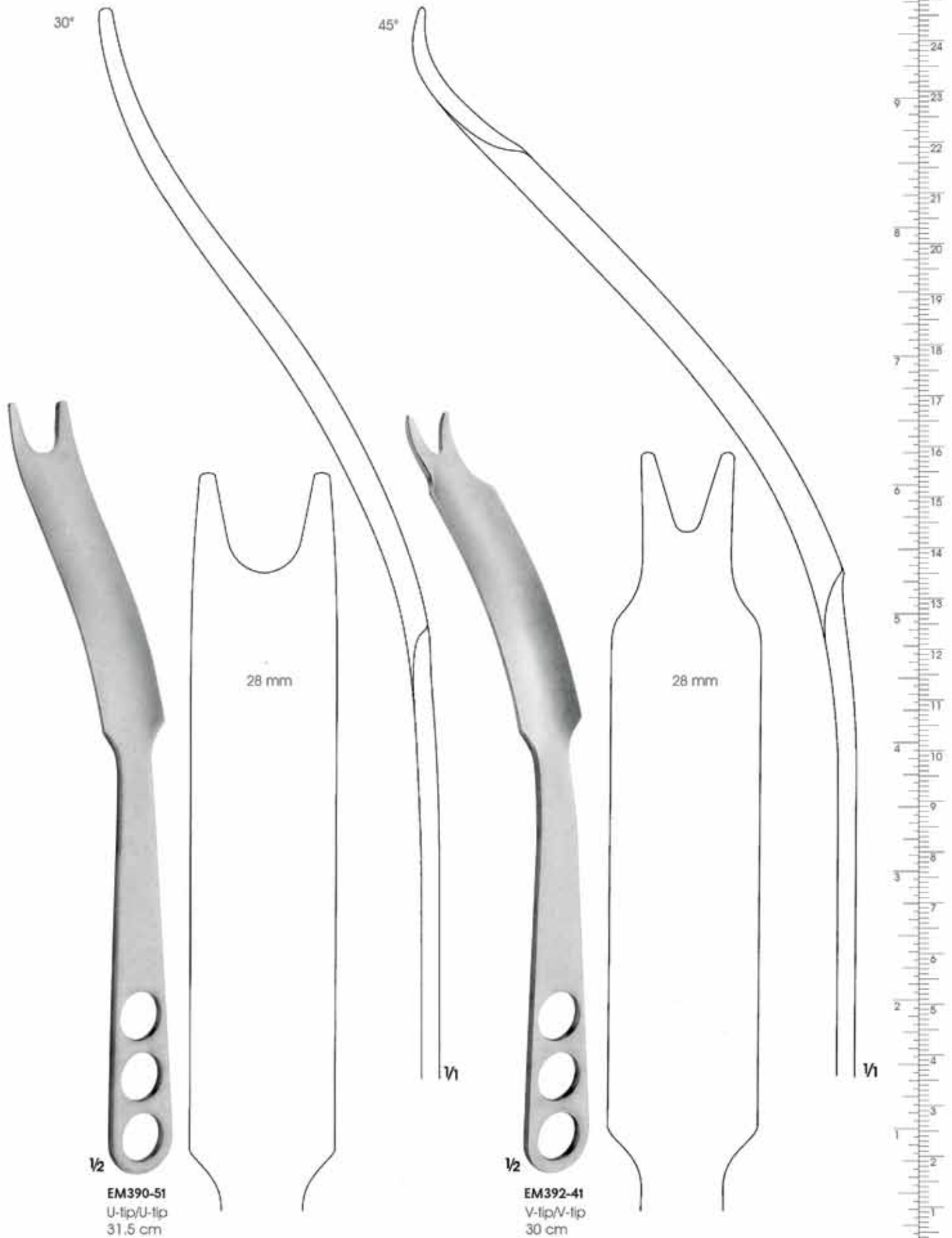

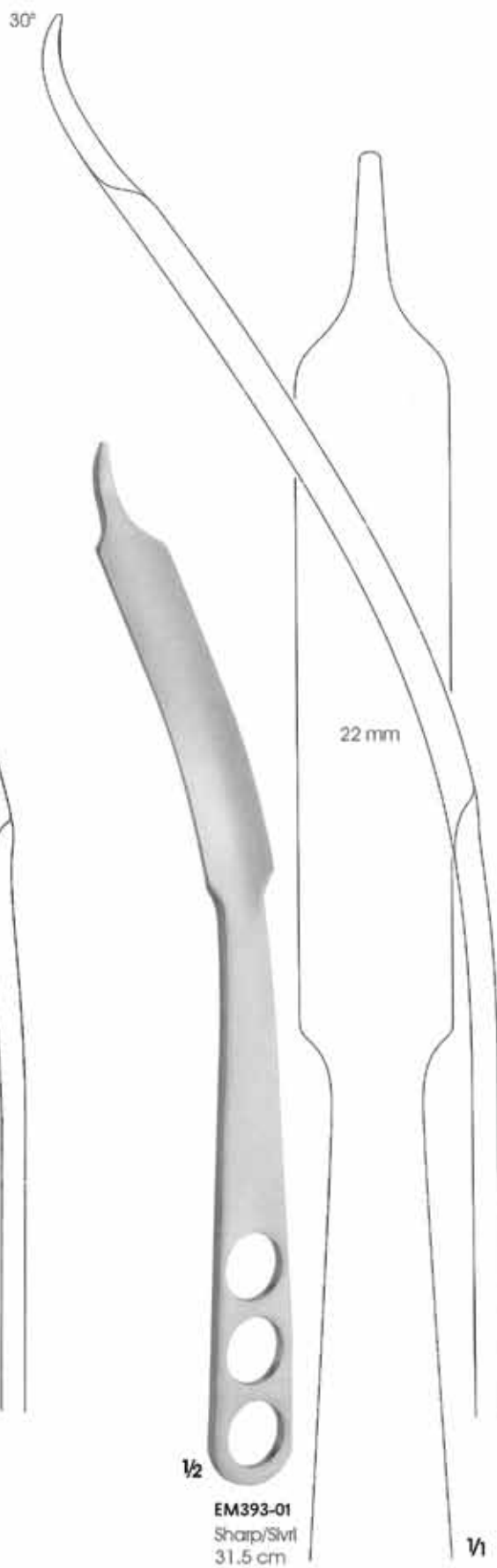
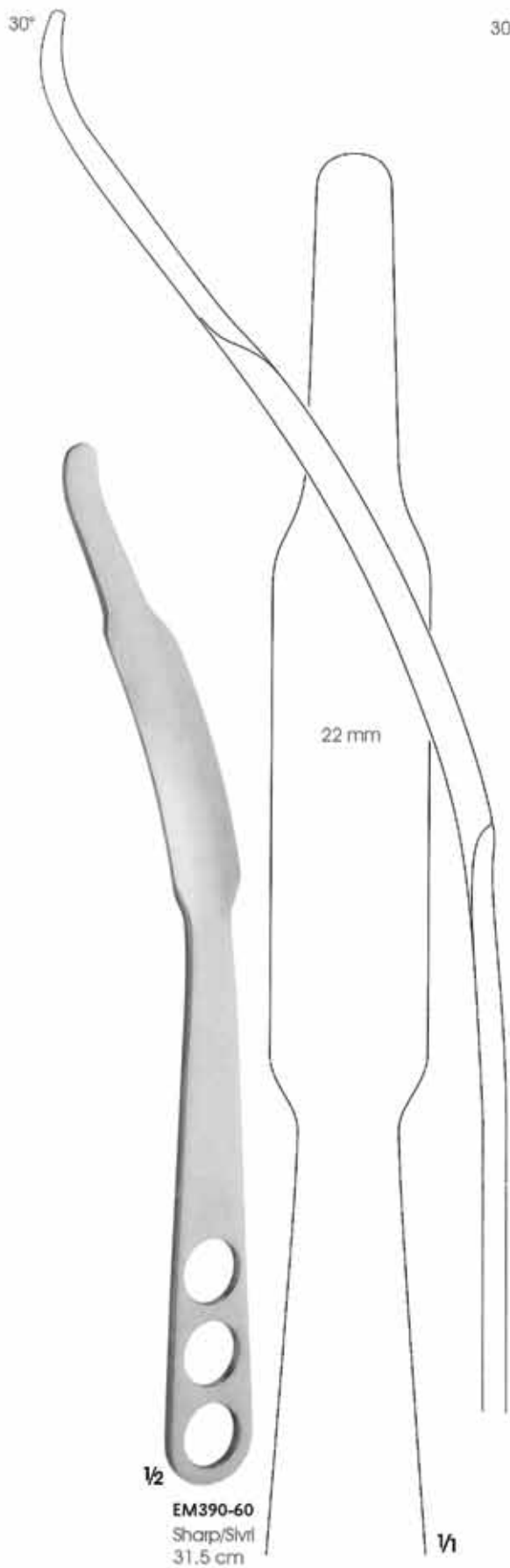

30°

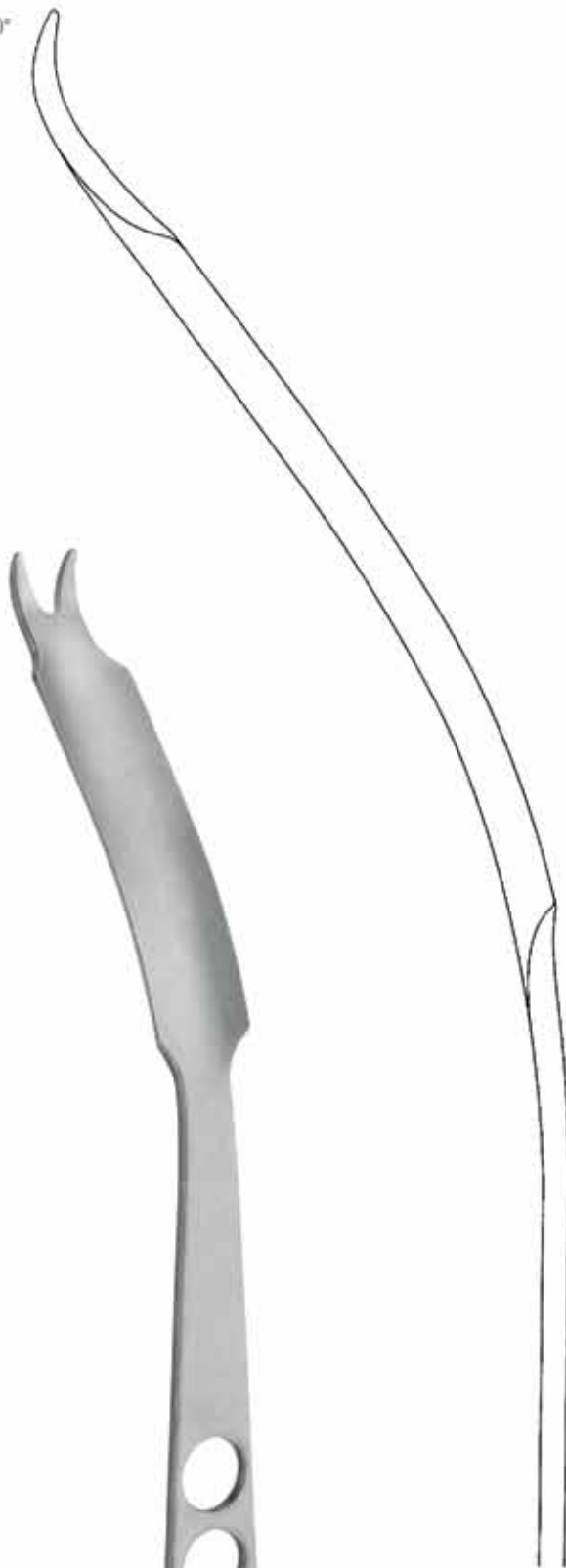

1/2

EM393-41
V-Tip/V-Tip
31,5 cm



28 mm

1/1

EM399-01
Kavrama silikonu
Hand grip

EM399-02
Kavrama silikonu
Hand grip

EM399-03
Kavrama silikonu
Hand grip

EM399-04
Kavrama silikonu
Hand grip

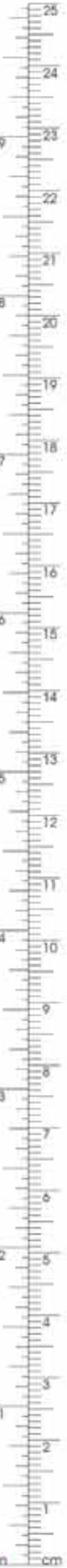

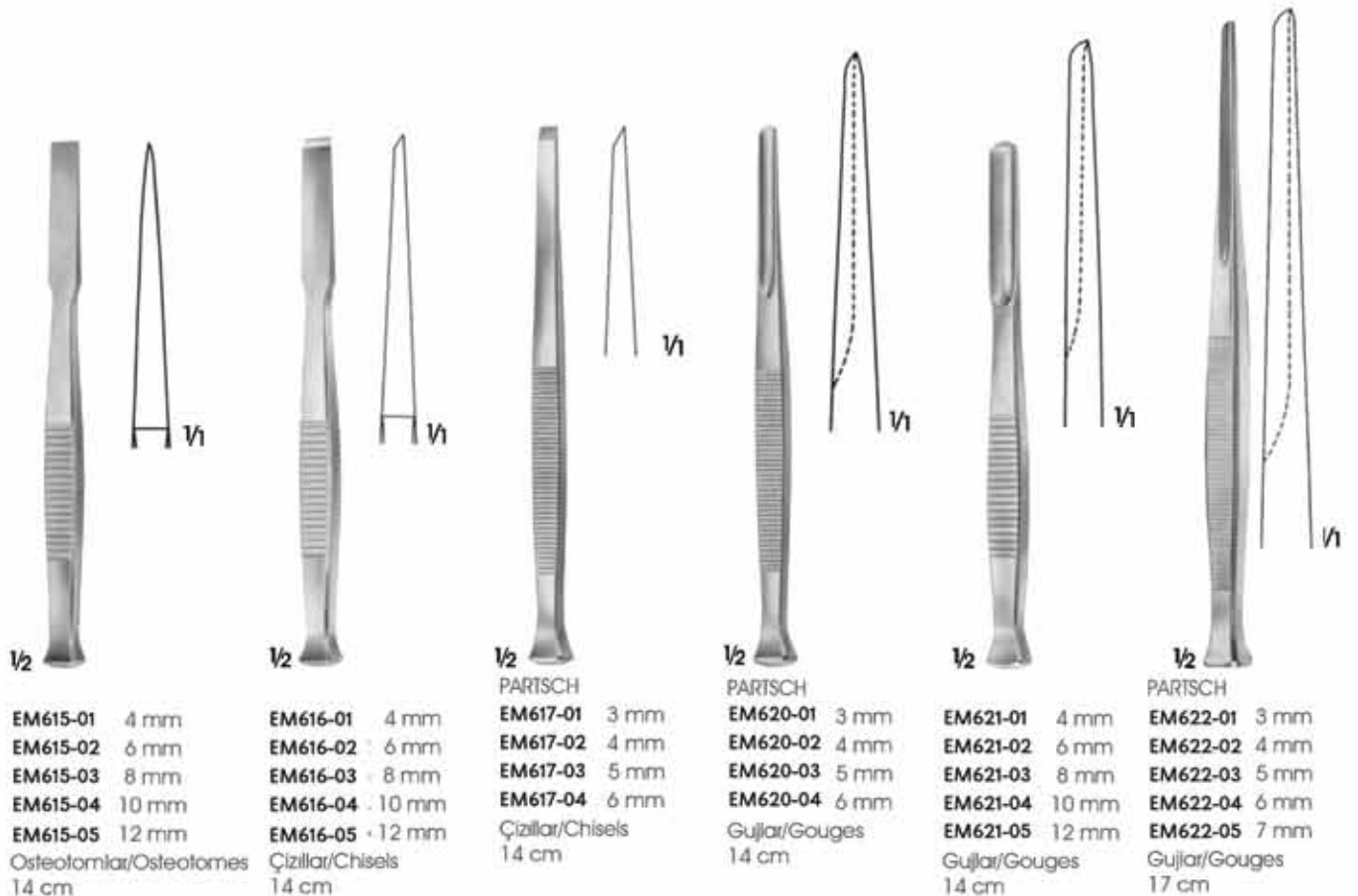
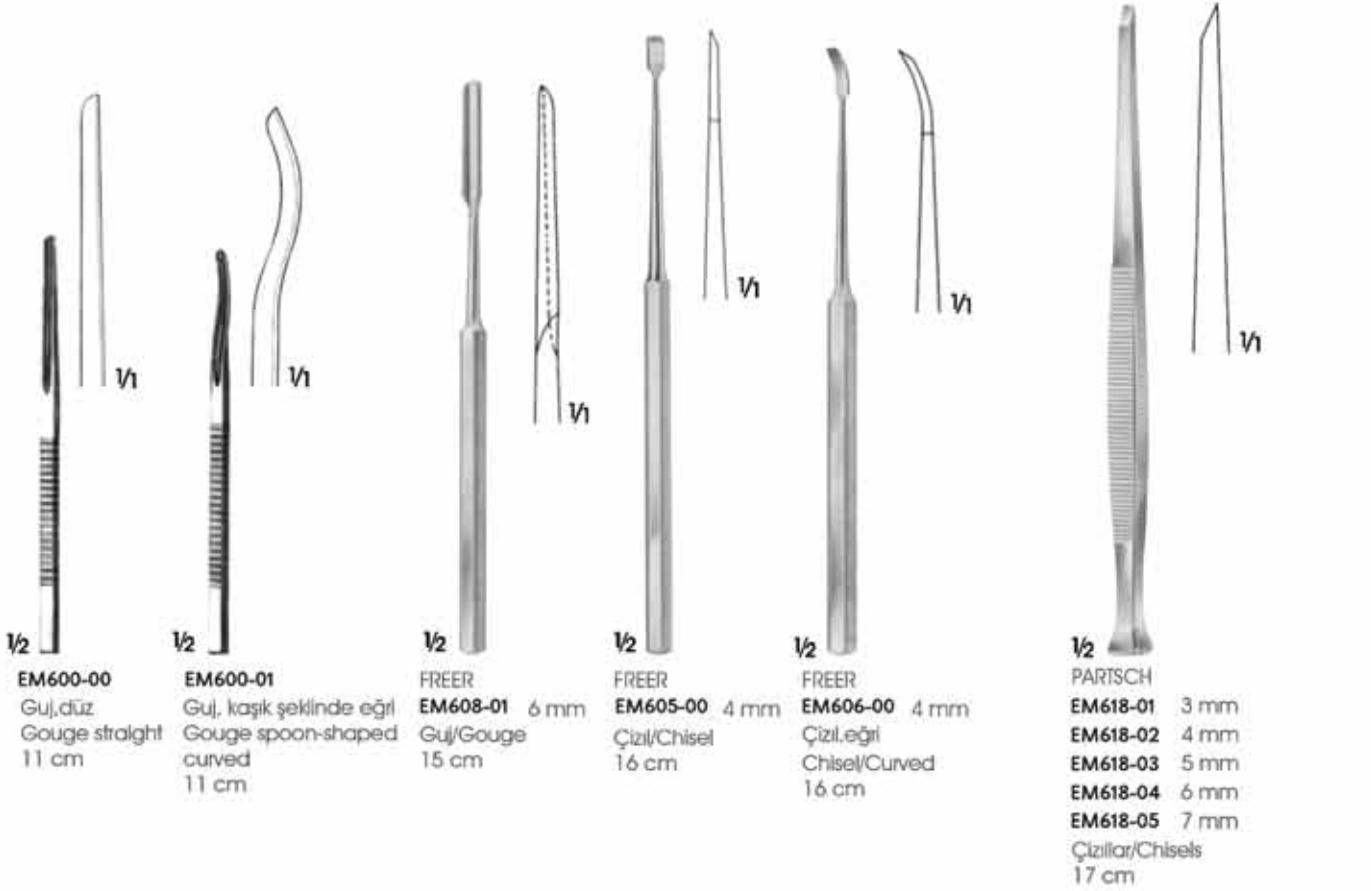

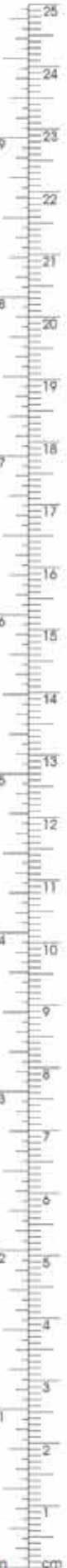
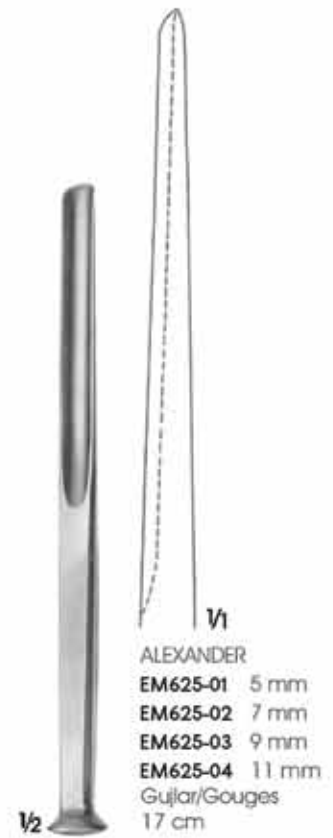
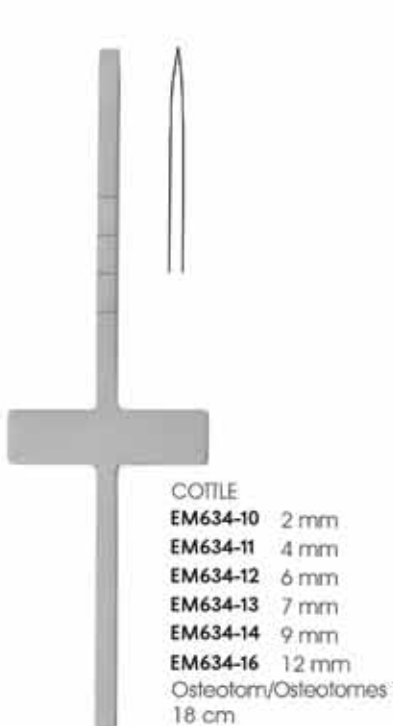
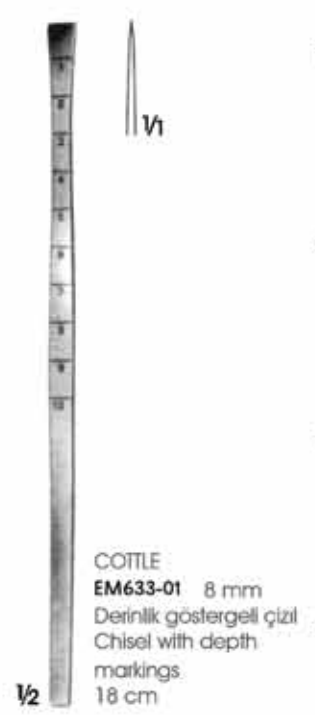
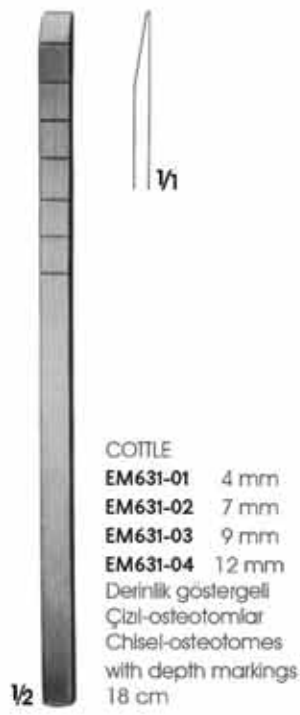
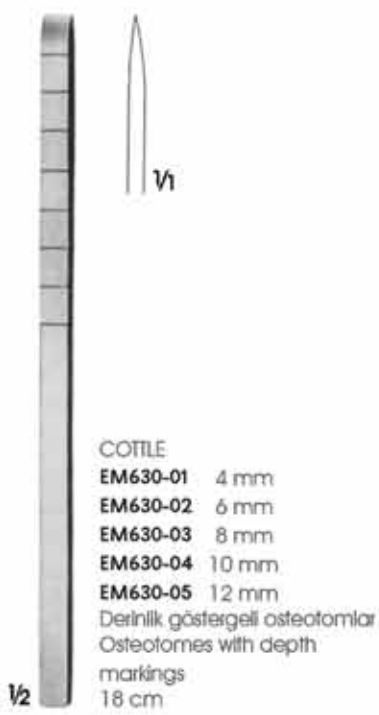

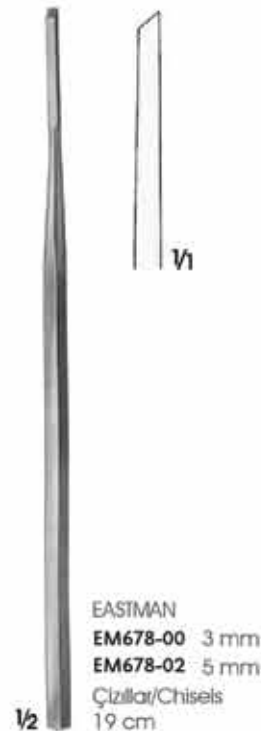
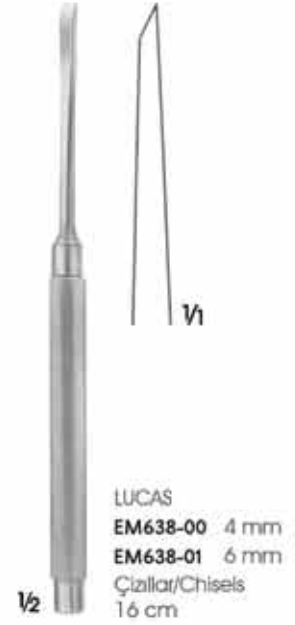
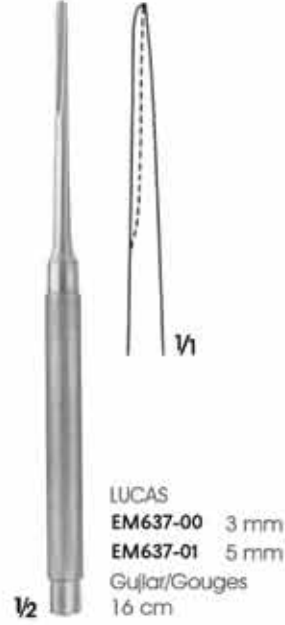
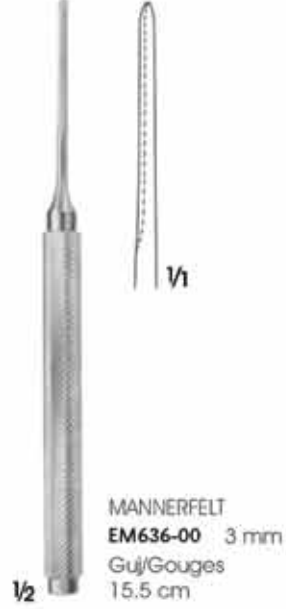

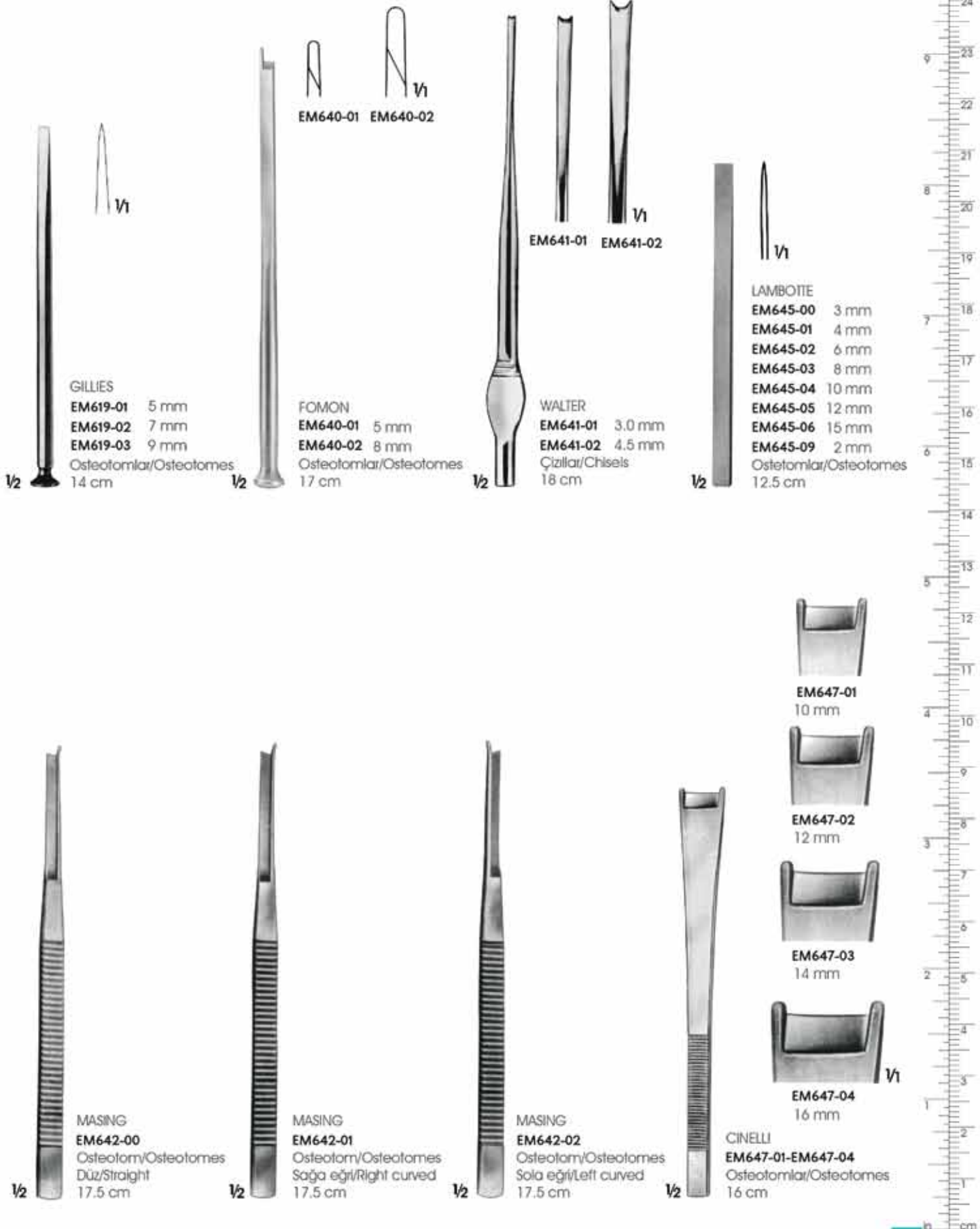

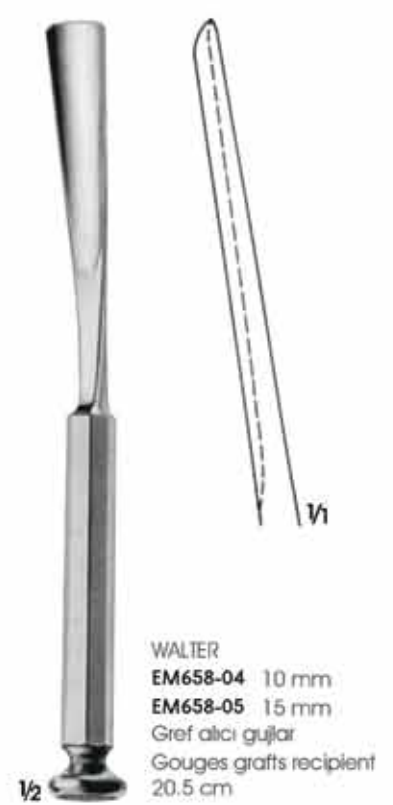
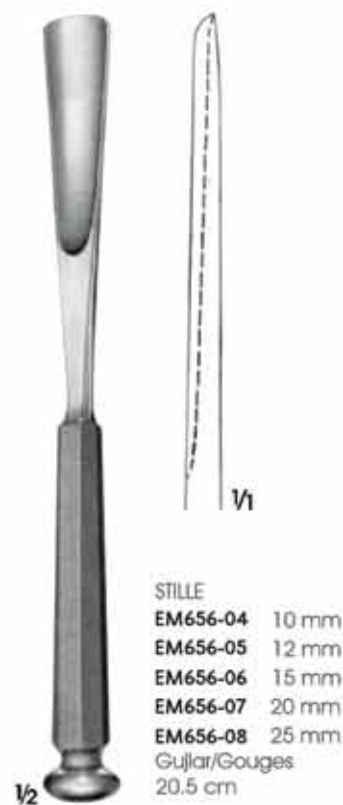
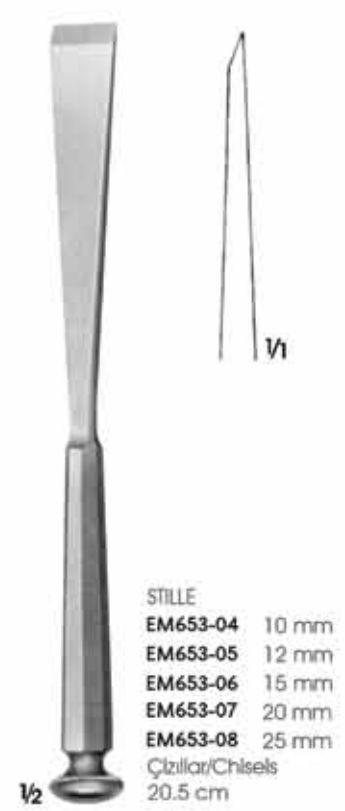
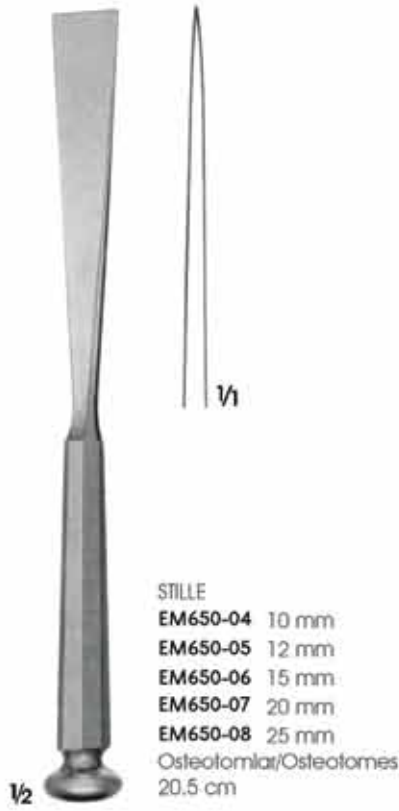



HIBBS

EM660-01 6 mm
EM660-08 10 mm
EM660-02 13 mm
EM660-09 16 mm
EM660-03 19 mm
EM660-10 22 mm
EM660-04 25 mm
EM660-11 28 mm
EM660-05 32 mm
EM660-13 38 mm
Osteotomlar
Osteotomes
24 cm

HIBBS

EM661-01 6 mm
EM661-08 10 mm
EM661-02 13 mm
EM661-09 16 mm
EM661-03 19 mm
EM661-10 22 mm
EM661-04 25 mm
EM661-11 28 mm
EM661-05 32 mm
EM661-13 38 mm
Osteotomlar
Osteotomes
24 cm

HIBBS

EM662-01 6 mm
EM662-02 13 mm
EM662-03 19 mm
EM662-04 25 mm
EM662-05 32 mm
Osteotomlar
Osteotomes
24 cm

HIBBS

EM664-01 6 mm
EM664-02 13 mm
EM664-03 19 mm
EM664-04 25 mm
EM664-05 32 mm
Gujlar/Gouges
24 cm

HIBBS

EM665-01 6 mm
EM665-02 13 mm
EM665-03 19 mm
EM665-04 25 mm
EM665-05 32 mm
Gujlar/Gouges
Egri/Curved
24 cm

SMITH-PETERSEN

EM670-01 7 mm
EM670-02 11 mm
EM670-03 14 mm
EM670-04 17 mm
EM670-05 19 mm
EM670-06 25 mm
EM670-07 32 mm
Osteotomlar
Osteotomes
20.5 cm

SMITH-PETERSEN

EM671-01 6 mm
EM671-02 9.5 mm
EM671-03 13 mm
EM671-04 16 mm
EM671-05 19 mm
EM671-06 25 mm
EM671-07 32 mm
Osteotomlar
Osteotomes
20.5 cm

SMITH-PETERSEN

EM673-01 6 mm
EM673-02 9 mm
EM673-03 13 mm
EM673-04 16 mm
EM673-05 19 mm
EM673-06 25 mm
EM673-07 32 mm
Gujlar/Gouges
20.5 cm

SMITH-PETERSEN

EM674-01 6 mm
EM674-02 9 mm
EM674-03 13 mm
EM674-04 16 mm
EM674-05 19 mm
EM674-06 25 mm
EM674-07 32 mm
Gujlar/Gouges
20.5 cm

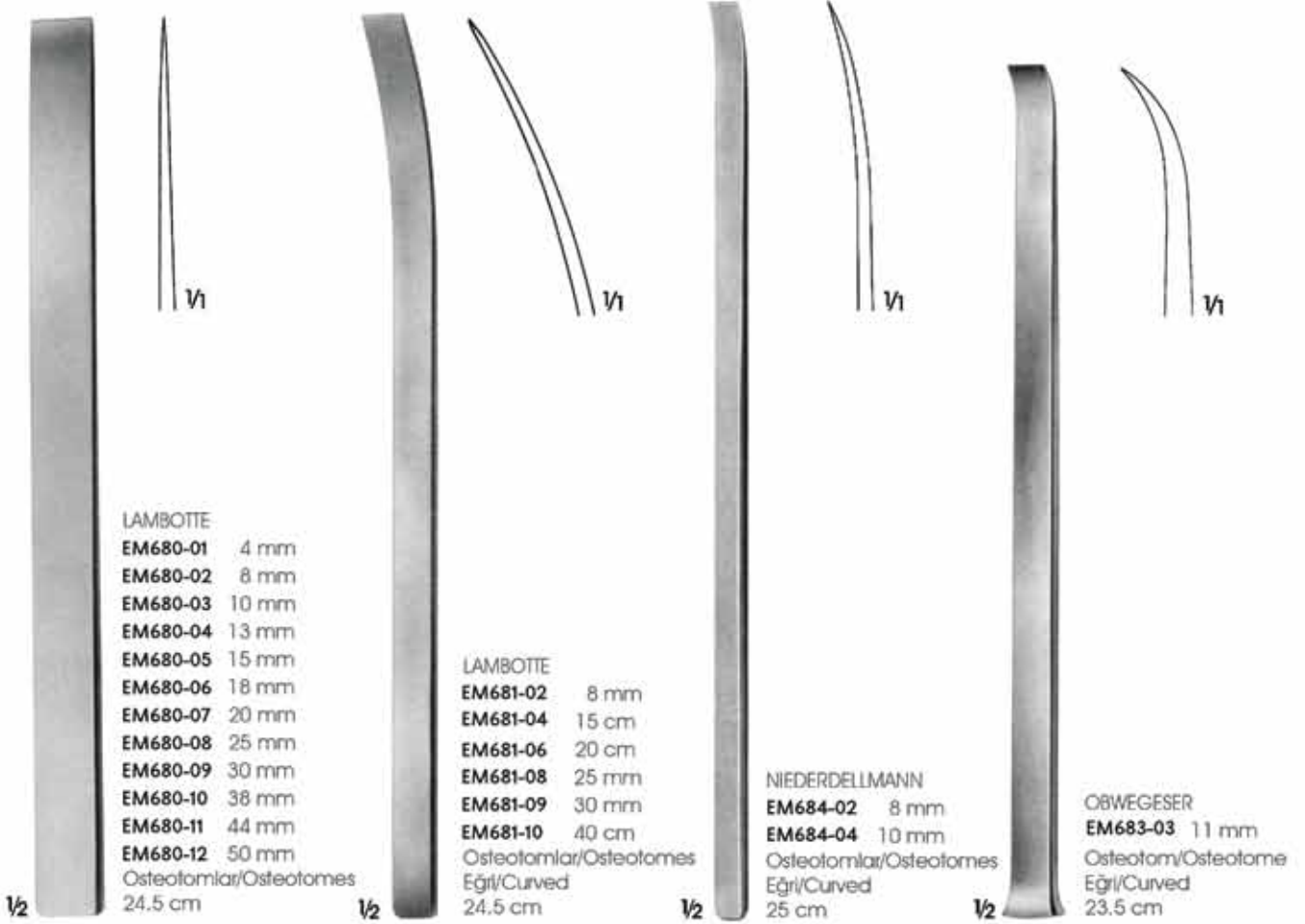

143° buhar sterilizatörlerinde steril edilebilir.
Can be sterilized in a steam sterilizer up to 143°



EV606-05
Anahtar/Key

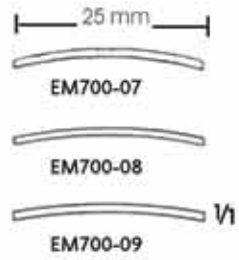

EM700-00P
Değiştirilebilir bıçaklı,
çizil
(V 606.05 ile)
Changeable blades,
chisel
(V 606.05 with key)



EM700-01 5 mm
EM700-02 10 mm
EM700-03 16 mm
EM700-04 25 mm
Boy/length 45 mm



EM700-05 25 mm
Boy/length 78 mm



EM700-07 50 mm
EM700-08 60 mm
EM700-09 70 mm

143° buhar sterilizatorlerinde steril edilebilir.
Can be sterilized in a steam sterilizer up to 143°

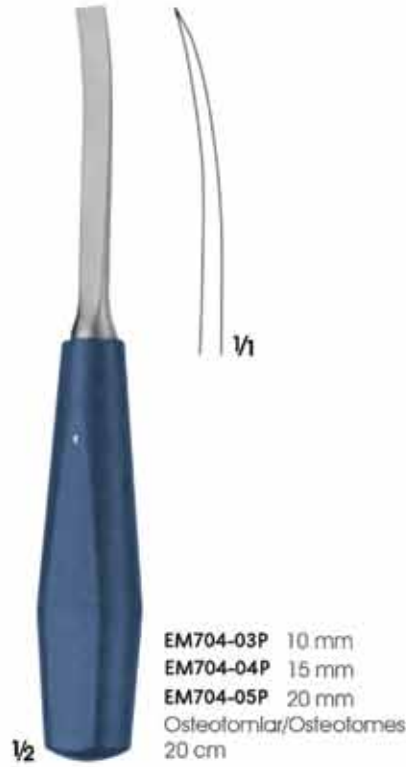
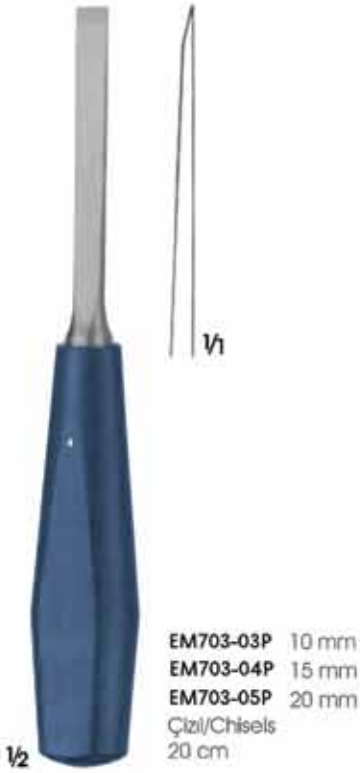

143° buhar sterilizatörlerinde steril edilebilir.
Can be sterilized in a steam sterilizer up to 143°



143° buhar sterilizatörlerinde steril edilebilir.
Can be sterilized in a steam sterilizer up to 143°



EM720-05P 20 mm
Çizil/Chisels
24.5 cm



EM721-04P 16 mm
Çizil, eğri
Chisel, curved
26.5 cm



LEXER
EM723-04P 10 mm
EM723-05P 15 mm
Osteotomlar, açılı
Osteotomes angled
27.5 cm

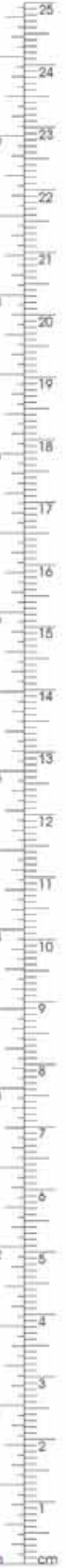

143° buhar sterilizatörlerinde steril edilebilir.
Can be sterilized in a steam sterilizer up to 143°

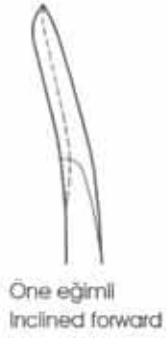
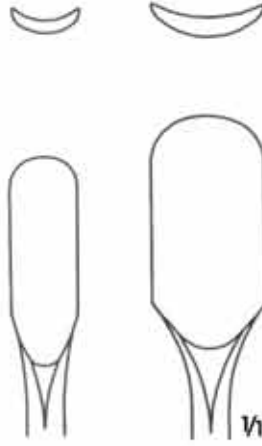

EM727-01P
9 mm

EM727-02P
15 mm



EM728-01P
9 mm

EM728-02P
15 mm

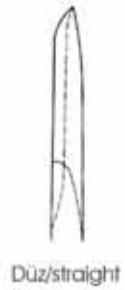

EM729-01P
9 mm

EM729-02P
15 mm

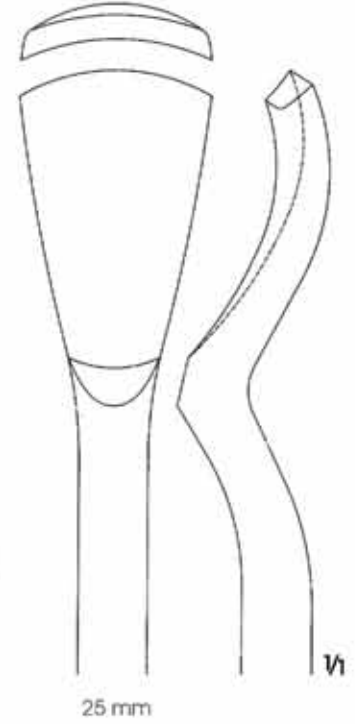

1/2

WAGNER
EM727-01P-EM727-02P
EM728-01P-EM728-02P
EM729-01P-EM729-02P
34 cm



1/2

EM737-01P P
29 cm

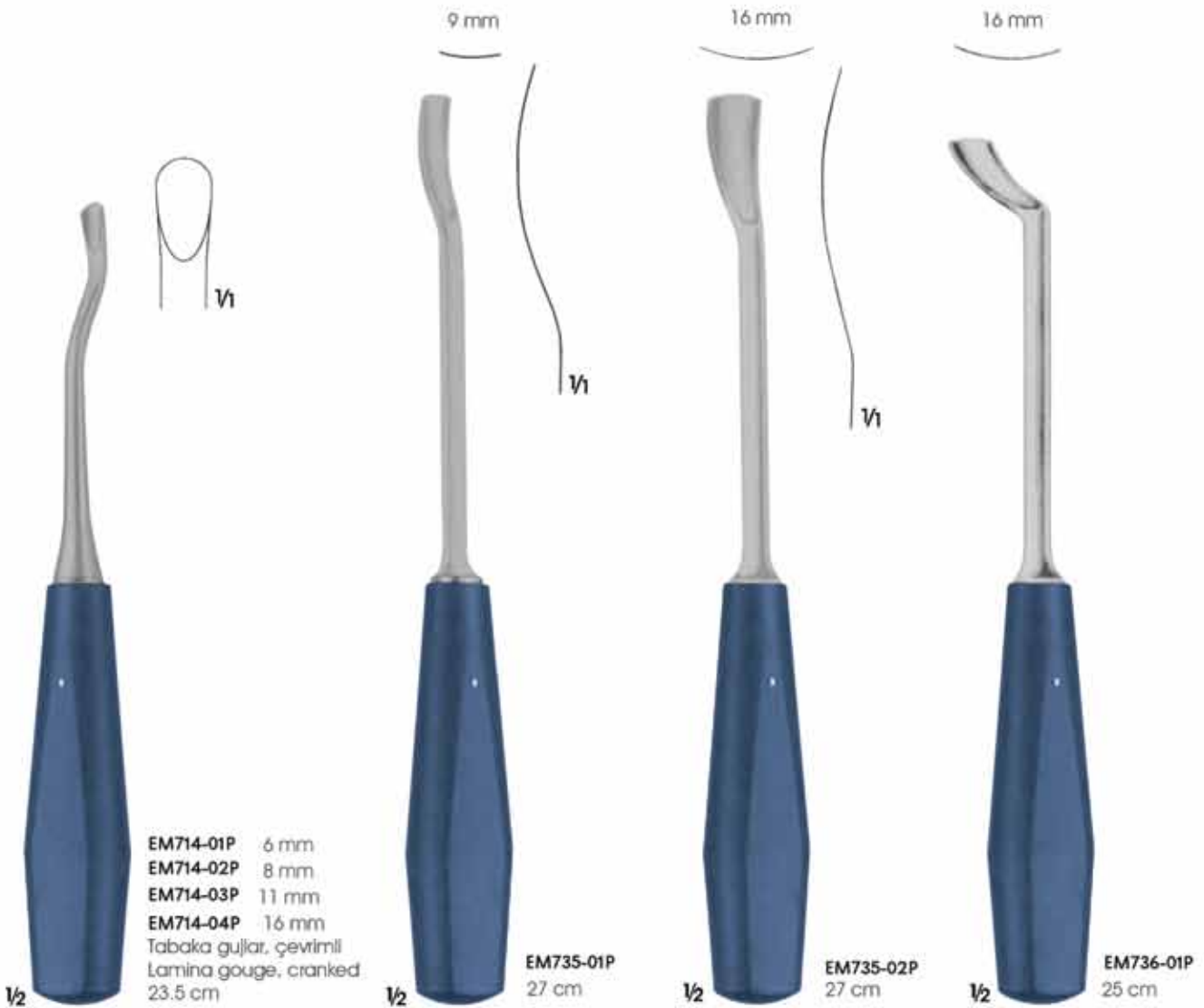

8 mm



1/2

COBB
EM740-02
28 cm

8 mm



1/2

COBB
EM741-02
28 cm

8 mm



1/2

COBB
EM742-02
28 cm

8 mm



1/2

COBB
EM743-02
28 cm

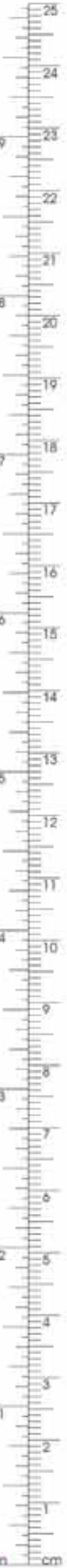
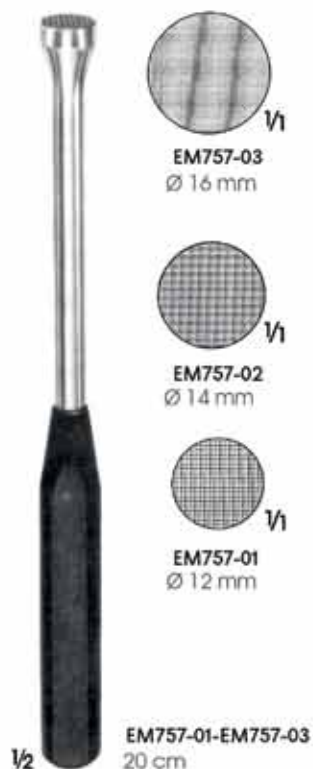
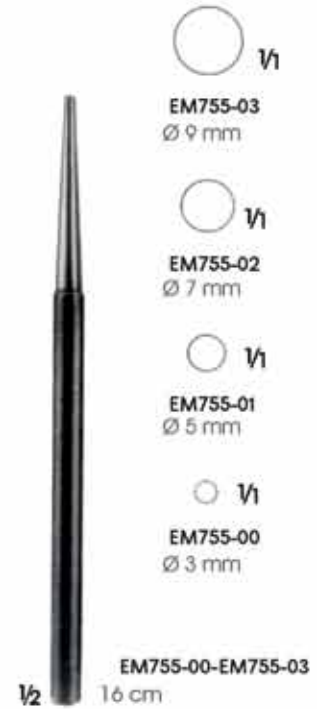
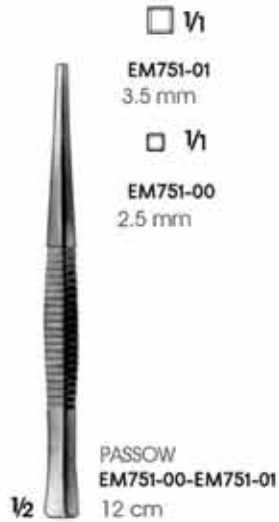

Çekiğin başlıklarına göre ağırlıkları değişebilir.
Weights refer to heads of the mallets.



Çekiğin başlıklarına göre ağırlıkları değişebilir
Weights refer to heads of the mallets



Çekiğin başlıklarına göre ağırlıkları değişebilir
Weights refer to heads of the mallets:



Ø 30 mm

1/2

COTTLE
EM815-01 235 gr
Bir tarafı düz, bir tarafı bombeli
Bir side flat, bir side convex
18.5cm



HEATH
EM816-01 660 gr
Ø 40 mm 18.5 cm
EM816-03 725 gr
Ø 45 mm 20 cm
Ağır ekliç
Triphammer



Ø 30 mm

1/2

BERGMANN
EM818-02 245 gr
23.5 cm



Ø 40 mm

1/2

OMBREDANNE
EM820-02 520 gr
24 cm



Çekiğin başlıklarına göre ağırlıkları değişebilir
Weights refer to heads of the mallets

Ø 45 mm

1/2

BERGMANN
EM819-02 300 gr
24.5 cm



Ø 30 mm

Ø 42 mm

1/2

EM822-02 285 gr
24 cm



143° buhar sterilizatörlerinde steril edilebilir.
Can be sterilized in a steam sterilizer up to 143°
POM malzeme / POM material

1/2

EM805-01 Ø 35 mm
EM805-02 Ø 42 mm
EM805-03 Ø 50 mm
25 cm



Ø 27 mm

Ø 13.5 mm

1/2

EM821-02 425 gr
İmplantlara uygun
ortopedik çekiç
Head made of material
used for implants
23.5 cm

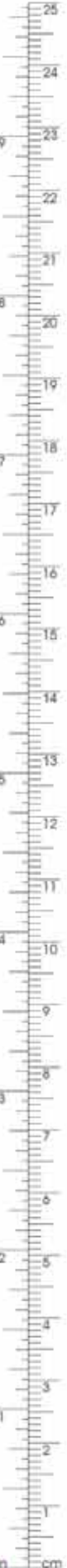



Ø 35 mm

Diskler olmadan çekiç kafa 125 gr
Mallet head without disks 125 gr



WAGNER
EM803-00S Komple/Complete
Metal disk M 803.02/Metal disc M 803.02
Plastik disk M 803.03/Plastic disc M 803.03
Anahtar M 803.10/Wrench M 803.10
23.5 cm

1/2



EM803-02 215 gr.
1 Metal disk, düz
1 Metal disc, flat
1 Metal disk, konveks
1 Metal disc, convex



EM803-03 30 gr.
1 Plastik disk, düz
1 Plastic disc, flat
1 Plastik disk, konveks
1 Plastic disc, convex

EM803-10
Anahtar/Wrench



HEATH
EM816-01S
660 gr
Ø 40 mm 18.5 cm

1/2



HEATH
EM816-03S
725 gr
Ø 45 mm 20 cm
Ağır çekiç
Triphammer

1/2



Ø 45 mm

BERGMANN
EM819-02S
300 gr
24.5 cm

1/2



Ø 30 mm

Ø 42 mm

285 gr
24 cm

1/2



Ø 27 mm

Ø 13.5 mm

EM821-02S
425 gr
Implantlara uygun
ortopedik çekic
Head made of material
used for implants
23.5 cm

1/2



mm

OMBREDANNE
EM820-02S
520 gr
24 cm

1/2

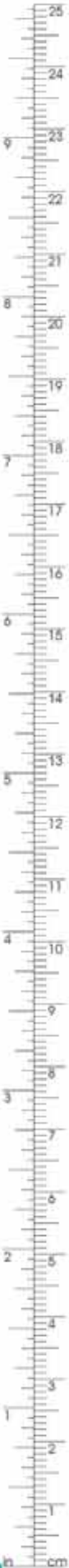

EN

Kemik Küretkeri
Bone Curettes



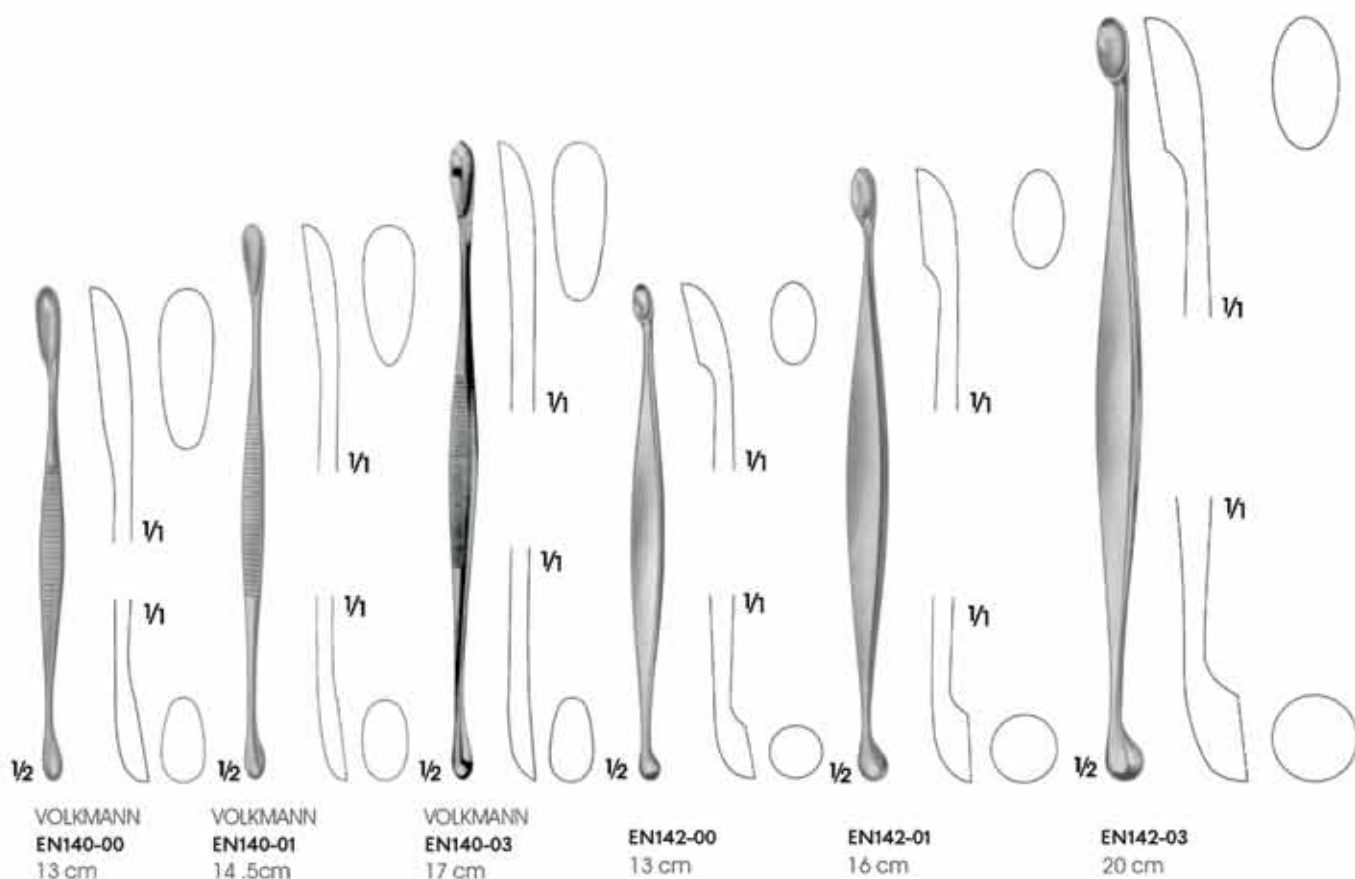
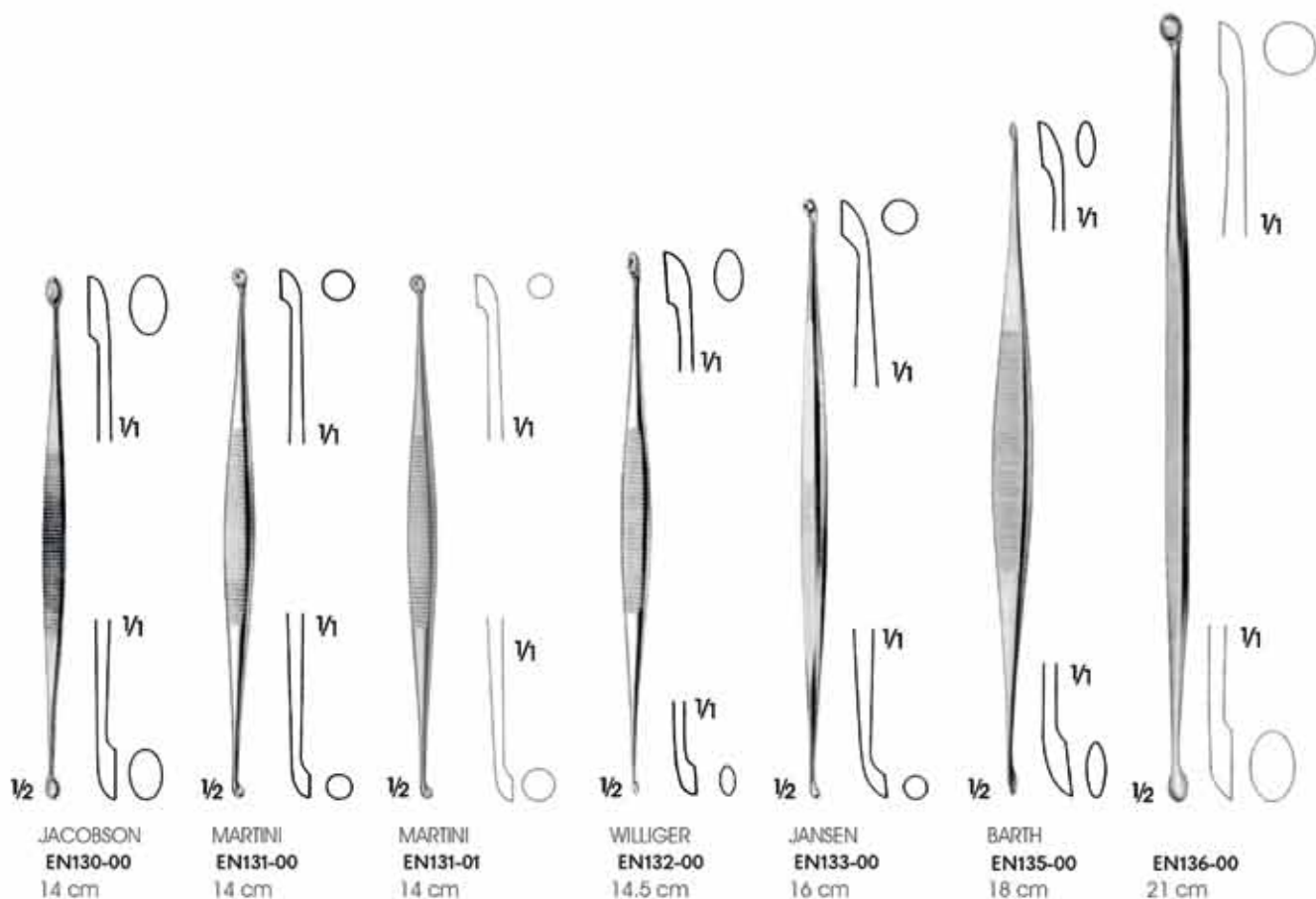

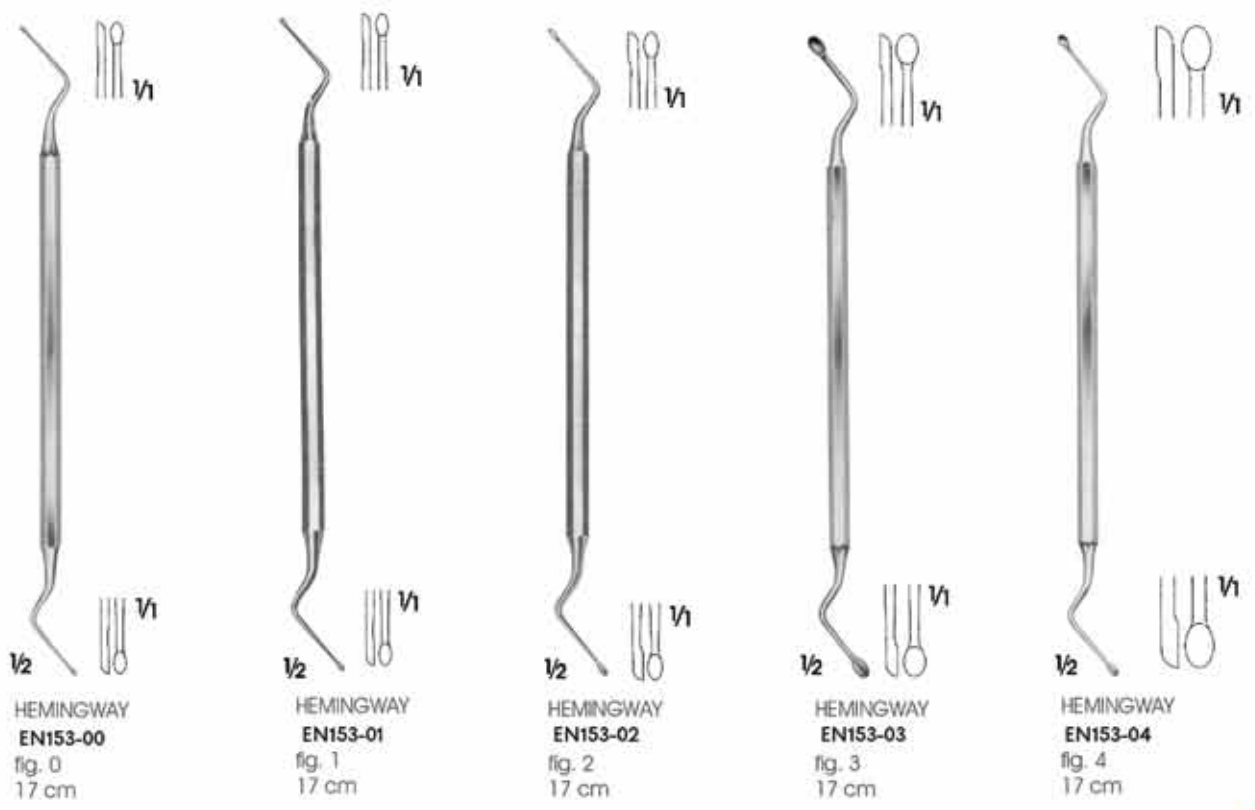
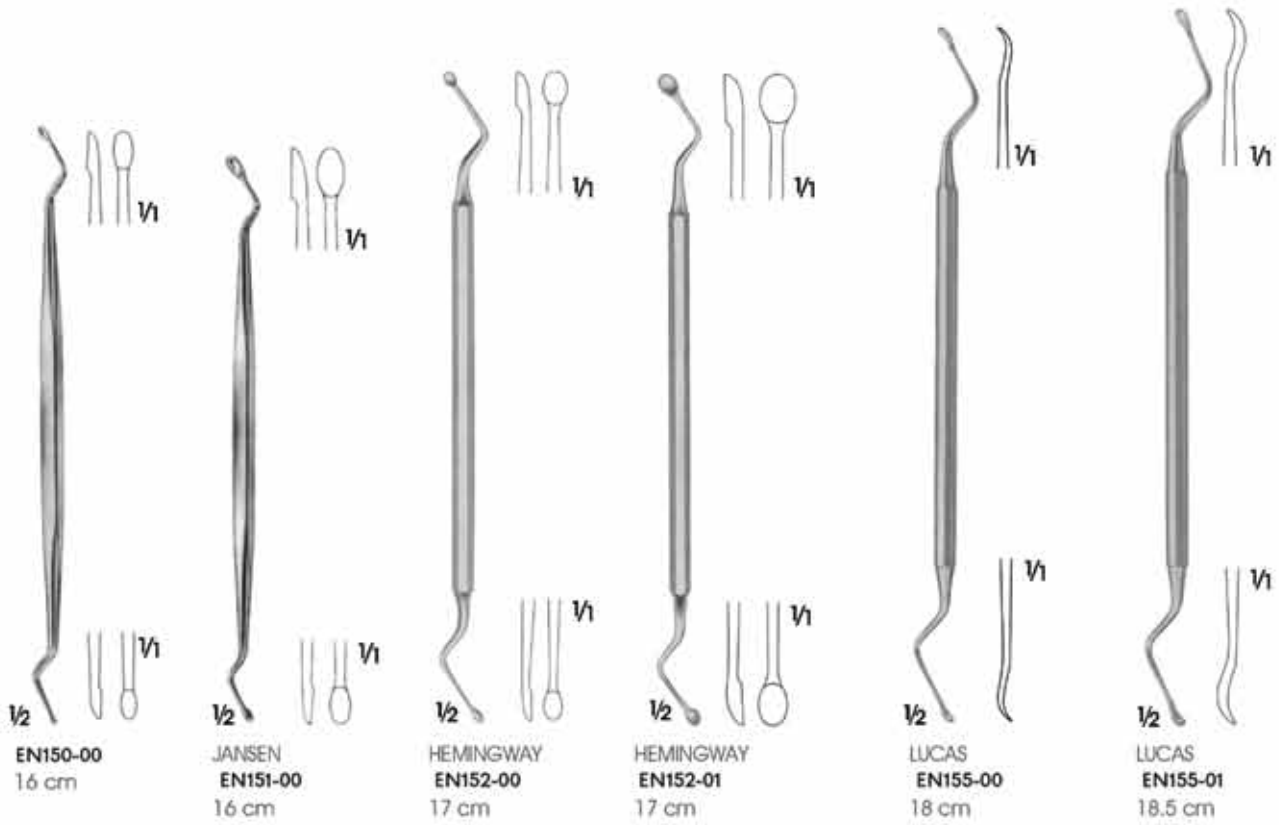











fig. 000	fig. 00	fig. 0	fig. 1
			
EN175-01 3 mm	EN175-02 3.5 mm	EN175-04 4 mm	EN175-05 5.5 mm
fig. 2	fig. 3	fig. 4	
			
EN175-06 7 mm	EN175-08 8 mm	EN177-09 10.5 mm	

1/2
SCHEDE
EN175-01-EN175-09
17 cm











fig. 000	fig. 00	fig. 0	fig. 1
			
EN176-01 2.5 mm	EN176-02 3.4 mm	EN176-03 4.2 mm	EN176-04 5.2 mm
fig. 2	fig. 3	fig. 4	
			
EN176-05 6.3 mm	EN176-06 7.4 mm	EN176-07 8 mm	

1/2
SCHEDE
EN176-01-EN176-07
17 cm











fig. 000	fig. 00	fig. 0	fig. 1
			
EN177-01 3 mm	EN177-02 4 mm	EN177-03 5 mm	EN177-04 6 mm
fig. 2	fig. 3	fig. 4	
			
EN177-05 8 mm	EN177-06 10 mm	EN177-07 12 mm	

1/2
BRUNS
EN177-01-EN177-07
16.5 cm











fig. 000	fig. 00	fig. 0	fig. 1
			
EN178-01 3 mm	EN178-02 4 mm	EN178-03 5 mm	EN178-04 6 mm
fig. 2	fig. 3	fig. 4	
			
EN178-05 8 mm	EN178-06 10 mm	EN178-07 12 mm	

1/2
BRUNS
EN178-01-EN178-07
16.5 cm



fig. 0000 EN179-01 2.8 mm	fig. 000 EN179-02 3.6 mm	fig. 00 EN179-03 4.4 mm	fig. 0 EN179-04 5.2 mm	fig. 1 EN179-05 6.8 mm
fig. 2 EN179-06 8.5 mm	fig. 3 EN179-07 10 mm	fig. 4 EN179-08 11.5 mm	fig. 5 EN179-09 13 mm	fig. 6 EN179-10 14.5 mm



fig. 00 EN180-01 3.4 mm	fig. 1 EN180-02 5.2 mm
-------------------------------	------------------------------

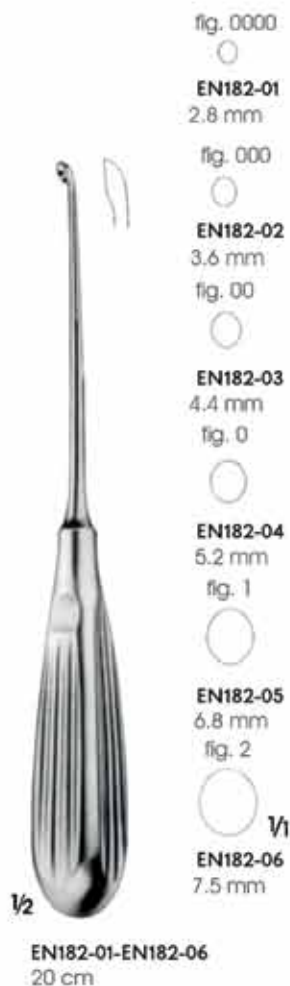

fig. 0000 EN182-01 2.8 mm	fig. 000 EN182-02 3.6 mm	fig. 00 EN182-03 4.4 mm	fig. 0 EN182-04 5.2 mm	fig. 1 EN182-05 6.8 mm	fig. 2 EN182-06 7.5 mm
---------------------------------	--------------------------------	-------------------------------	------------------------------	------------------------------	------------------------------

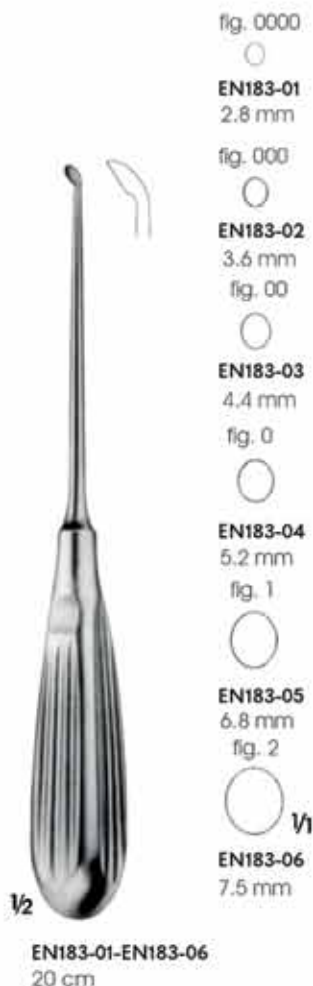

fig. 0000 EN183-01 2.8 mm	fig. 000 EN183-02 3.6 mm	fig. 00 EN183-03 4.4 mm	fig. 0 EN183-04 5.2 mm	fig. 1 EN183-05 6.8 mm	fig. 2 EN183-06 7.5 mm
---------------------------------	--------------------------------	-------------------------------	------------------------------	------------------------------	------------------------------

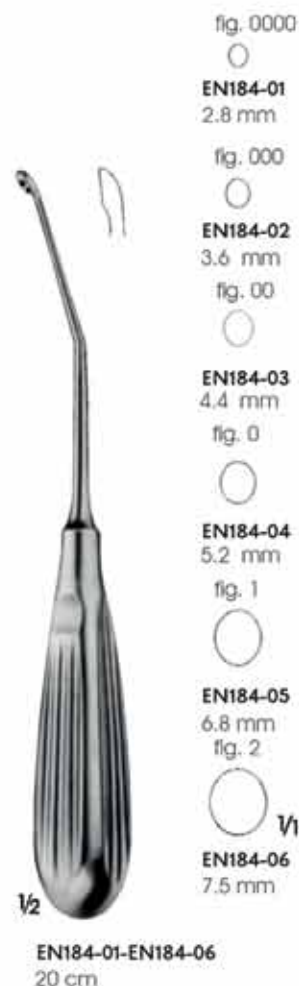
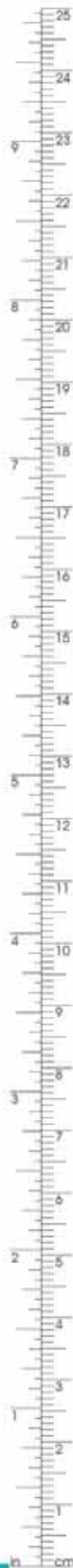
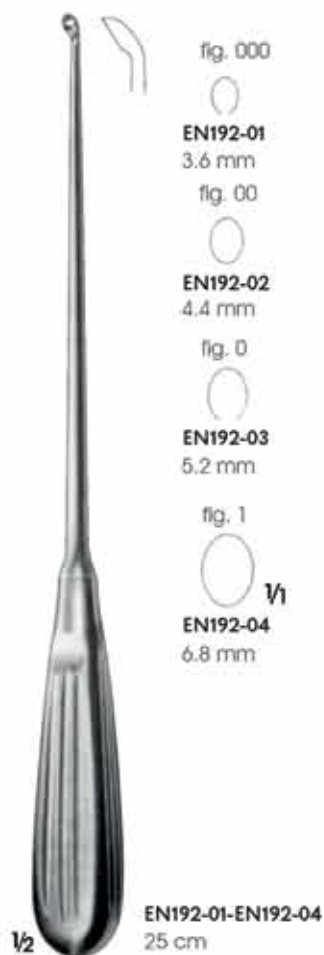
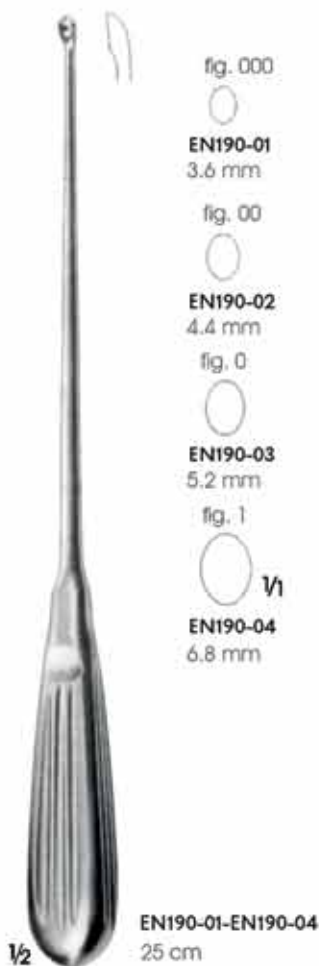
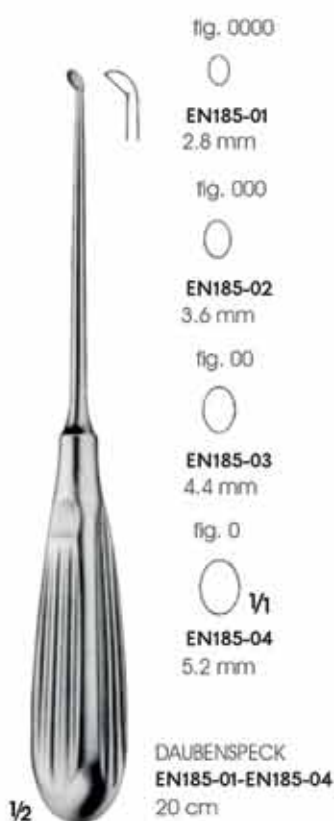
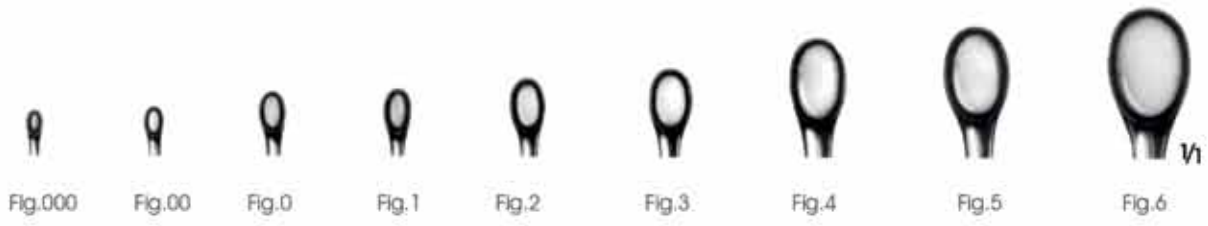

fig. 0000 EN184-01 2.8 mm	fig. 000 EN184-02 3.6 mm	fig. 00 EN184-03 4.4 mm	fig. 0 EN184-04 5.2 mm	fig. 1 EN184-05 6.8 mm	fig. 2 EN184-06 7.5 mm
---------------------------------	--------------------------------	-------------------------------	------------------------------	------------------------------	------------------------------







EN200-01 1.8 mm	EN200-02 2.2 mm	EN200-03 3.5 mm	EN200-04 4.0 mm	EN200-05 4.5 mm	EN200-06 5.5 mm	EN200-07 7.2 mm	EN200-08 8.5 mm	EN200-09 10.5 mm
EN202-01 1.8 mm	EN202-02 2.2 mm	EN202-03 3.5 mm	EN202-04 4.0 mm	EN202-05 4.5 mm	EN202-06 5.5 mm	EN202-07 7.2 mm	EN202-08 8.5 mm	EN202-09 10.5 mm
EN203-01 1.8 mm	EN203-02 2.2 mm	EN203-03 3.5 mm	EN203-04 4.0 mm	EN203-05 4.5 mm	EN203-06 5.5 mm	EN203-07 7.2 mm	EN203-08 8.5 mm	EN203-09 10.5 mm





EN205-01 1.8 mm	EN205-02 2.2 mm	EN205-03 3.5 mm	EN205-04 4.0 mm	EN205-05 4.5 mm	EN205-06 5.5 mm	EN205-07 7.2 mm	EN205-08 8.5 mm	EN205-09 10.5 mm
EN206-01 1.8 mm	EN206-02 2.2 mm	EN206-03 3.5 mm	EN206-04 4.0 mm	EN206-05 4.5 mm	EN206-06 5.5 mm	EN206-07 7.2 mm	EN206-08 8.5 mm	EN206-09 10.5 mm
EN210-01 1.8 mm	EN210-02 2.2 mm	EN210-03 3.5 mm	EN210-04 4.0 mm	EN210-05 4.5 mm	EN210-06 5.5 mm	EN210-07 7.2 mm	EN210-08 8.5 mm	EN210-09 10.5 mm
EN211-01 1.8 mm	EN211-02 2.2 mm	EN211-03 3.5 mm	EN211-04 4.0 mm	EN211-05 4.5 mm	EN211-06 5.5 mm	EN211-07 7.2 mm	EN211-08 8.5 mm	EN211-09 10.5 mm



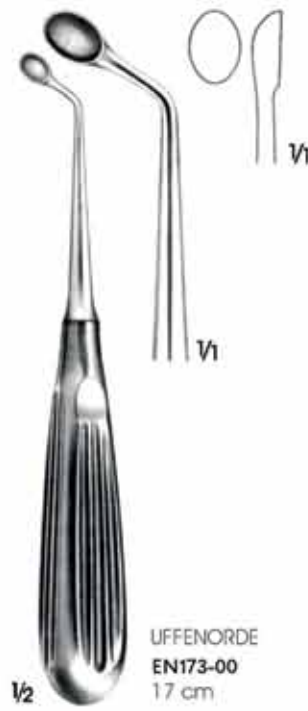



EN420-00-EN421-14
21.5 cm

Öne/Forward
Düz/Straight



0000	000	00	0	1
0	0	0	0	0
EN420-00	EN420-01	EN420-02	EN420-03	EN420-04

Öne/Forward
Açılı/Angle



0000	000	00	0	1
0	0	0	0	0
EN421-00	EN421-01	EN421-02	EN421-03	EN421-04

Geriyeye/Backward
Düz/Straight



0000	000	00	0	1
0	0	0	0	0
EN420-10	EN420-11	EN420-12	EN420-13	EN420-14

Geriyeye/Backward
Açılı/Angle



0000	000	00	0	1
0	0	0	0	0
EN421-10	EN421-11	EN421-12	EN421-13	EN421-14



EN423-00-EN424-14
24 cm

Öne/Forward
Düz/Straight



0000	000	00	0	1
0	0	0	0	0
EN423-00	EN423-01	EN423-02	EN423-03	EN423-04

Öne/Forward
Açılı/Angle



0000	000	00	0	1
0	0	0	0	0
EN424-00	EN424-01	EN424-02	EN424-03	EN424-04

Geriyeye/Backward
Düz/Straight



0000	000	00	0	1
0	0	0	0	0
EN423-10	EN423-11	EN423-12	EN423-13	EN423-14

Geriyeye/Backward
Açılı/Angle



0000	000	00	0	1
0	0	0	0	0
EN424-10	EN424-11	EN424-12	EN424-13	EN424-14



EN430-00-EN432-02
24 cm

Geriyeye/Backward
Düz/Straight



0



EN430-00

1



EN430-01

2



EN430-02

Geriyeye/Backward
Açılı/Angle



0



EN431-00

1



EN431-01

2



EN431-02

Geriyeye/Backward
Aşağı/Down



0



EN432-00

1



EN432-01

2



EN432-02



EN430-10-EN432-12
24 cm

Öne/Forward
Düz/Straight



0



EN430-10

1



EN430-11

2



EN430-12

Öne/Forward
Açılı/Angle



0



EN431-10

1



EN431-11

2



EN431-12

Öne/Forward
Aşağı/Down



0



EN432-10

1



EN432-11

2



EN432-12



143° buhar sterilizatörlerinde steril edilebilir.
Can be sterilized in a steam sterilizer up to 143°



143° buhar sterilizatörlerinde steril edilebilir.
Can be sterilized in a steam sterilizer up to 143°

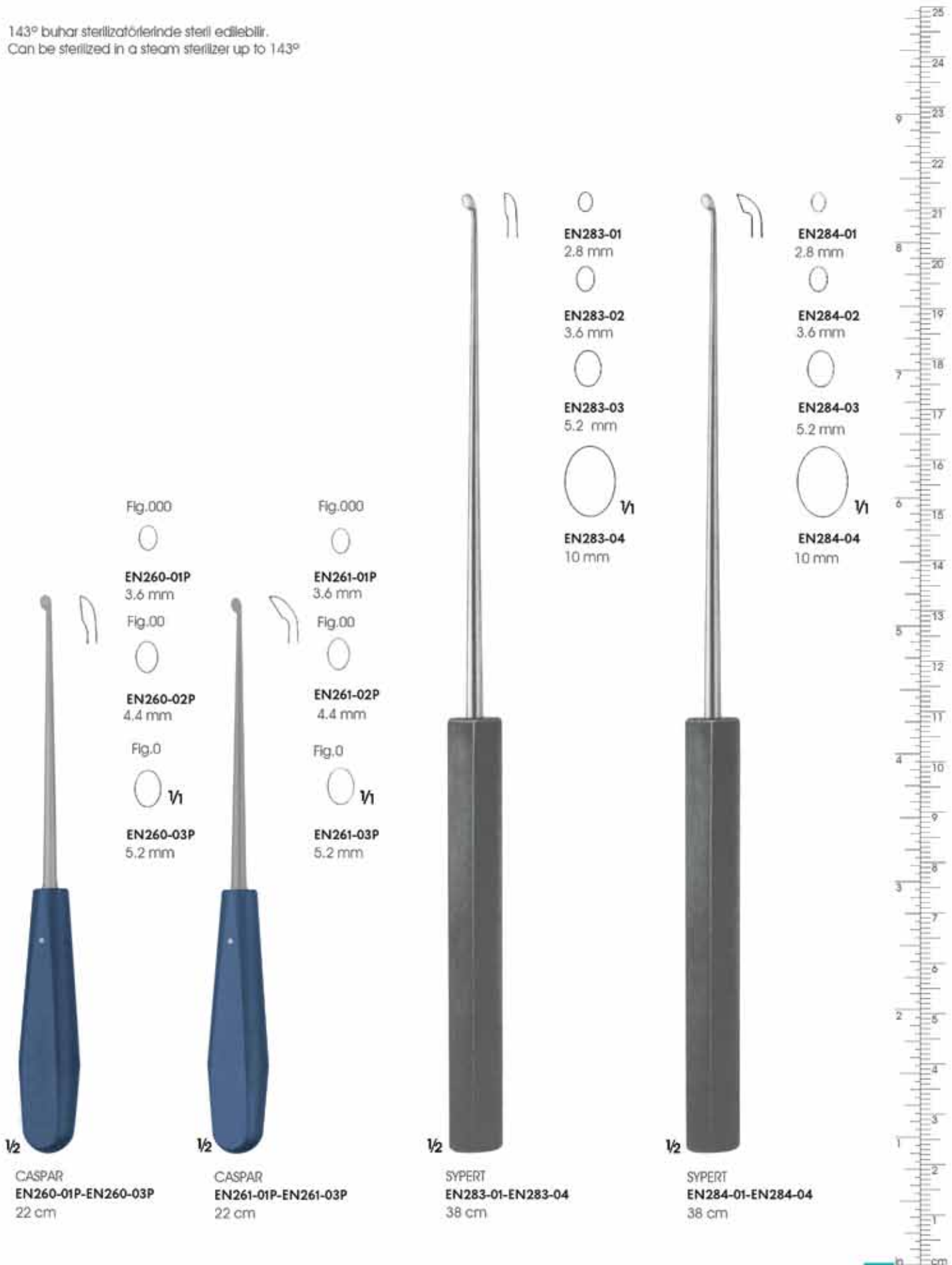

1/2
CASPAR
EN260-01P-EN260-03P
22 cm

1/2
CASPAR
EN261-01P-EN261-03P
22 cm

1/2
SYPERT
EN283-01-EN283-04
38 cm

1/2
SYPERT
EN284-01-EN284-04
38 cm

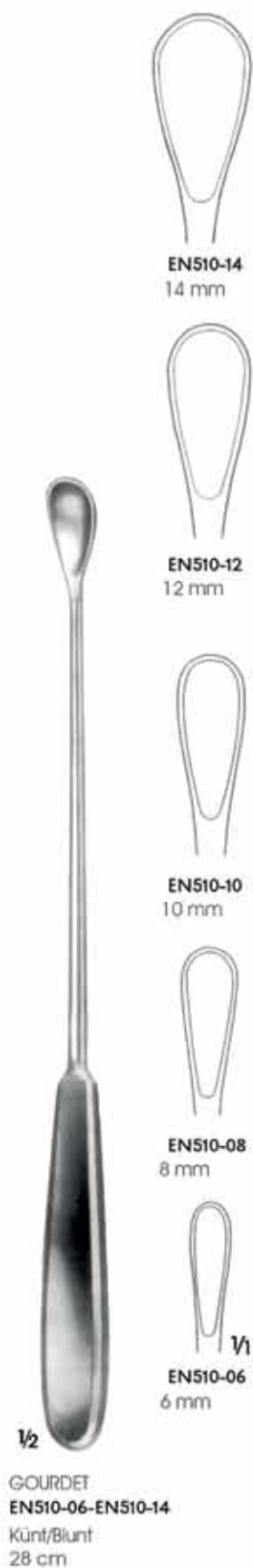
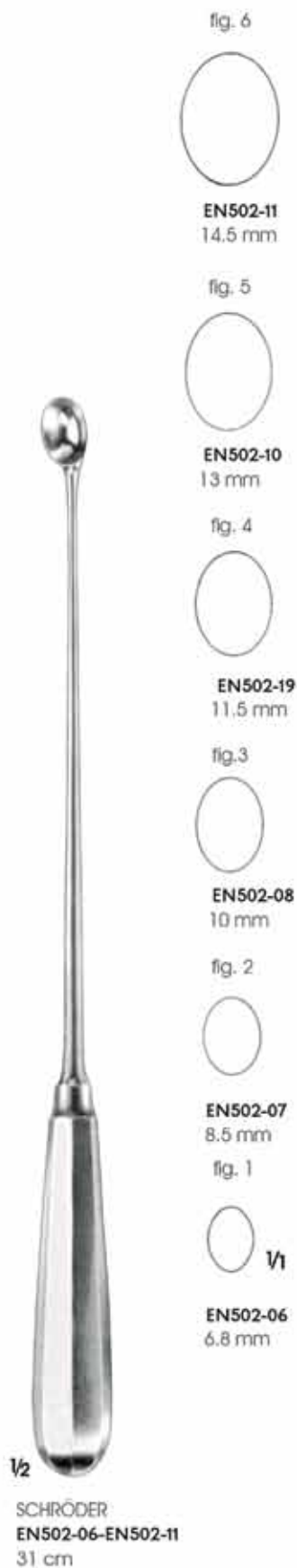

143° buhar sterilizörlerinde steril edilebilir.
Can be sterilized in a steam sterilizer up to 143°



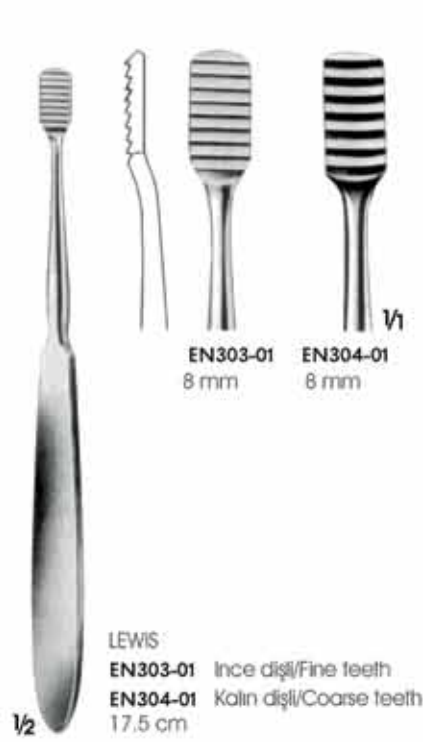

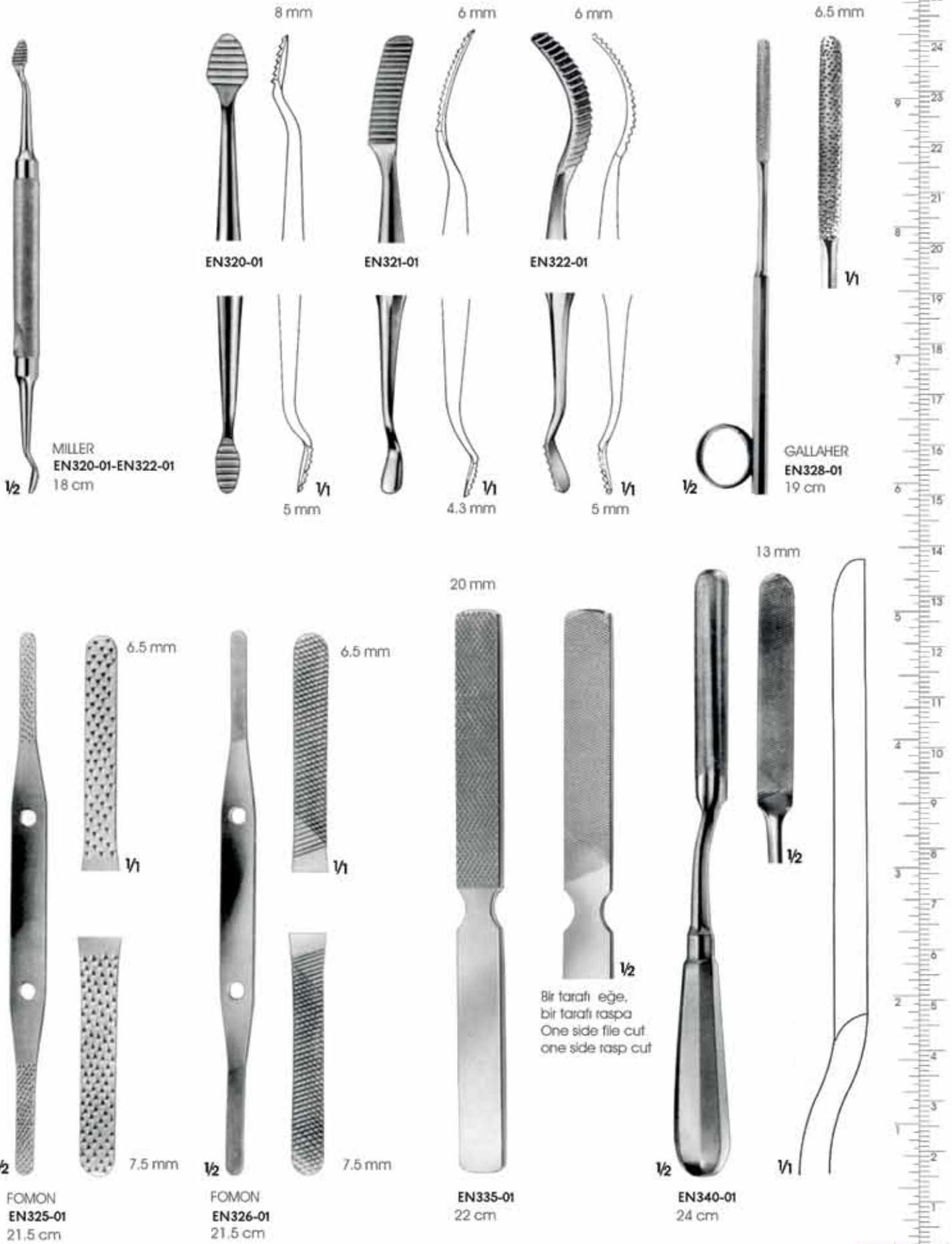

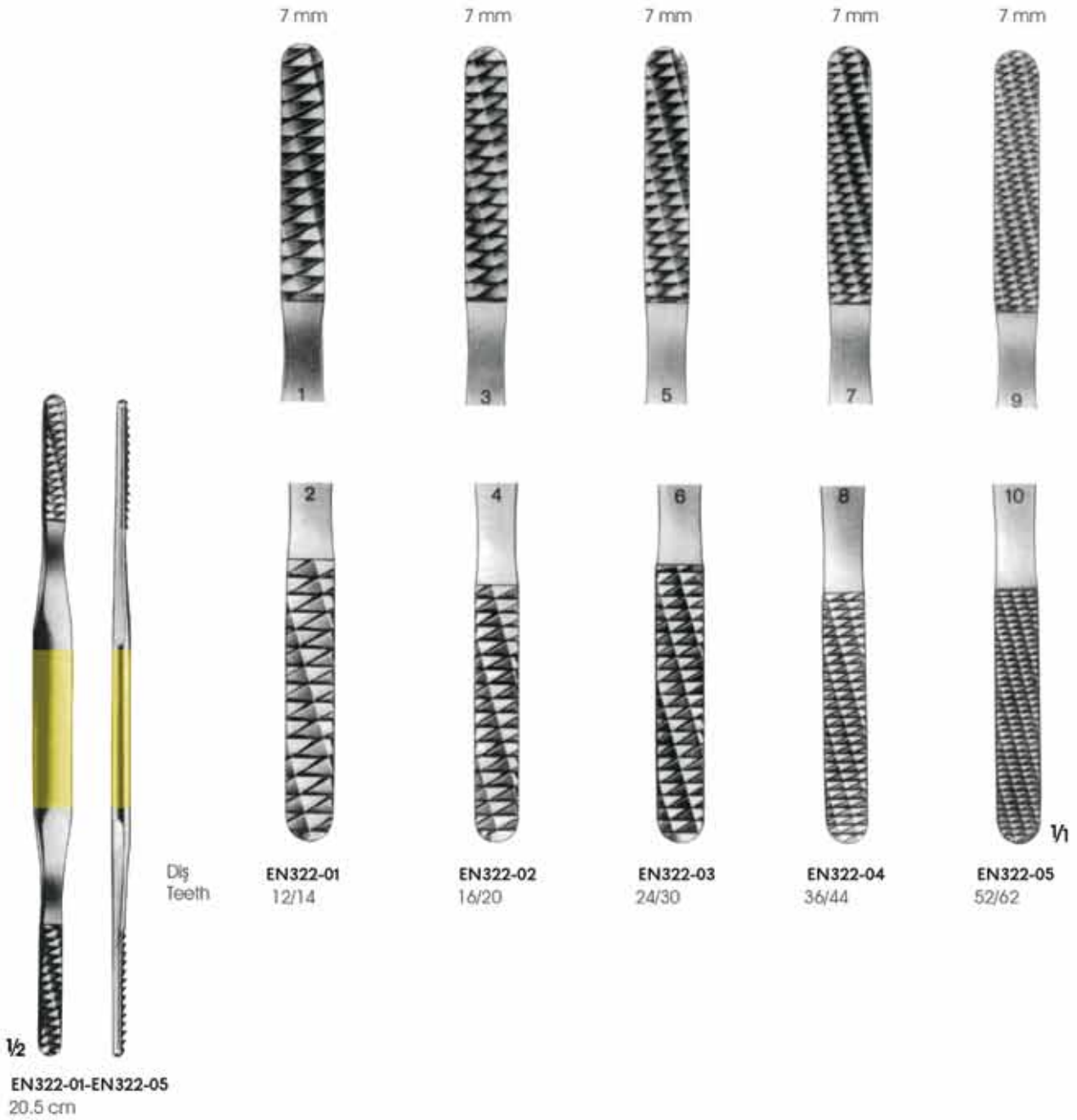

18 mm



1/2
20 mm
PUTTI
EN345-01
27 cm

20 mm



1/2
EN348-01
29.5 cm



1/2
PUTTI
EN347-01
30 cm



EP

Kemik Pensleri, Ronjurları, Makasları ve Pançları
Bone Holding Forceps, Rongeurs, Scissors and Punches



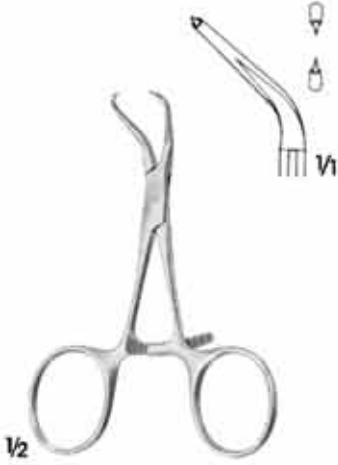

EP100-00
Setil, pozisyon pensli
Reposition forceps with
stepped tips
9.5 cm



EP102-00
Küçük parçaları
konumlandırma pensli
Reposition forceps for small
fragments
13.5 cm

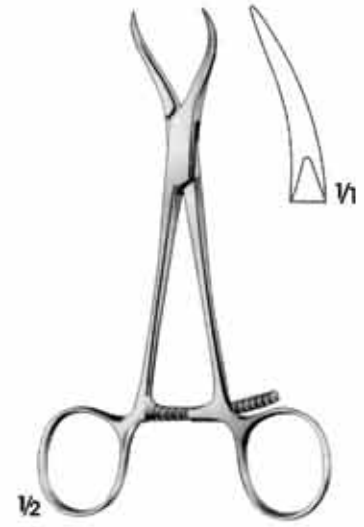

EP103-00
Çene kemiğine alt
konumlandırma pensli
Reposition forceps, especially
for maxillary reposition
13.5 cm

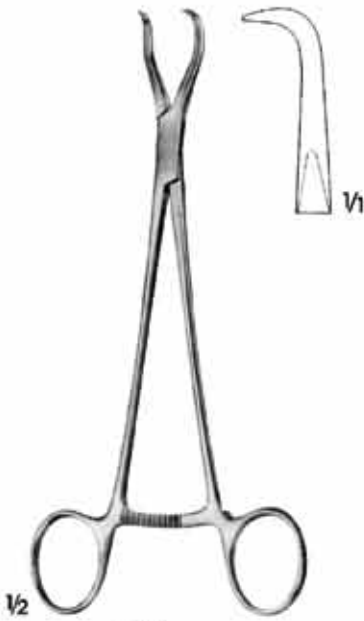

HAASE
EP105-00
Pozisyon pensli, çeneye alt
kırıklar için
Reposition forceps for
mandibular fractures
16.5 cm



REILL
EP106-00
Pozisyon pensli
Reposition forceps
17 cm

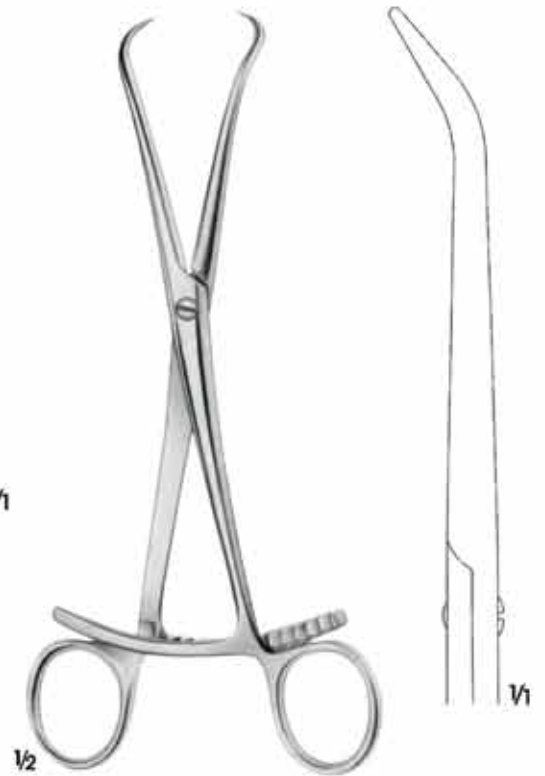

EP107-01
Pozisyon pensli
Reposition forceps
20.5 cm



1/2

FÖRSTNER
EP120-01
14 cm



1/2

EP123-00
13.5 cm



1/2

HAASE
EP124-00
14 cm

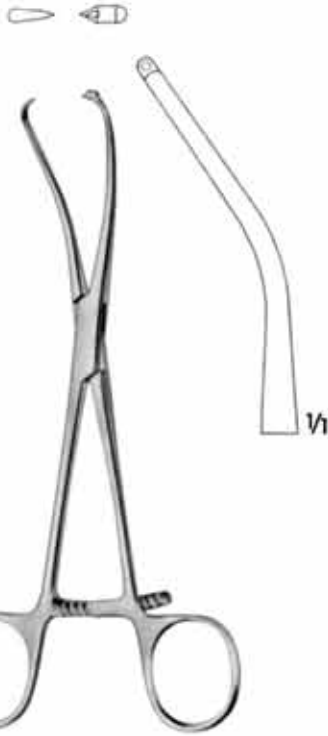

1/2

MEYER
EP110-00
Kışner telleri için matkap kılavuzu,
yeniden konumlandırıcı
Reposition forceps for fingers,
with drill guide for KIRSCHNER
kullanılan tel Ø 1.0 mm
For wires with Ø 1.0 mm
17 cm

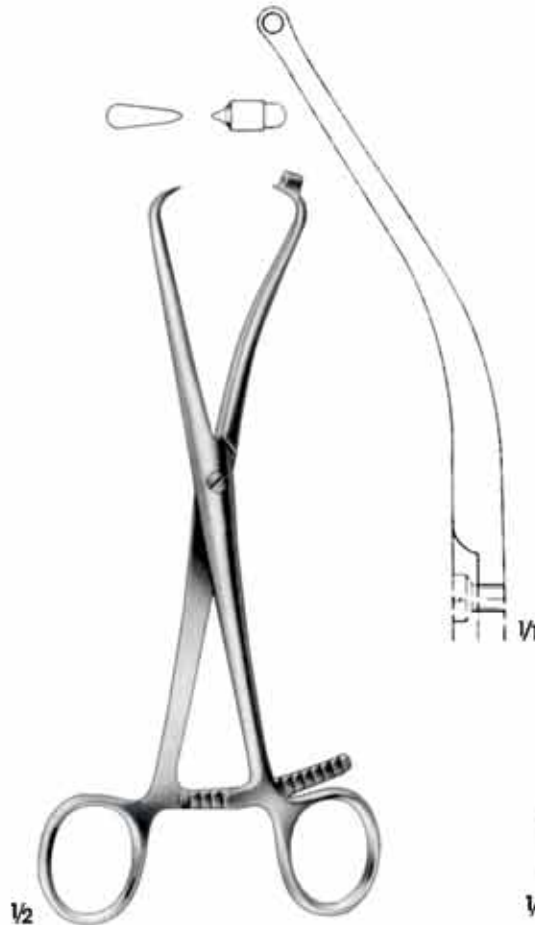

1/2

MEYER
EP112-00
Kışner telleri için matkap kılavuzu,
yeniden konumlandırıcı
Reposition forceps for fingers,
with drill guide for KIRSCHNER
kullanılan tel Ø 2.0 mm
For wires with Ø 2.0 mm
20.5 cm

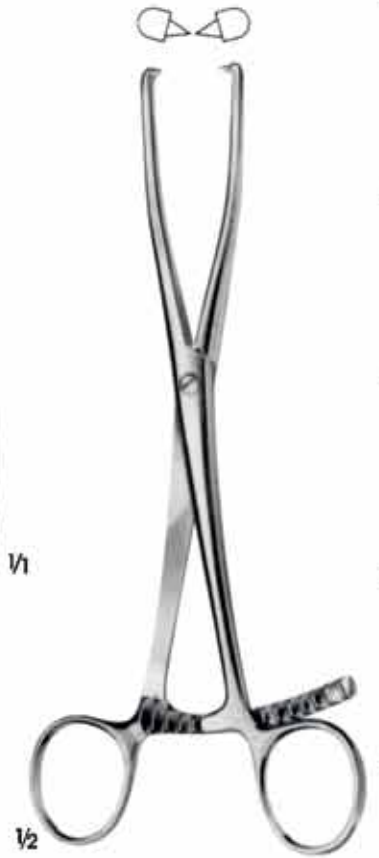

1/2

EP113-00
Malleolus pens
Malleolar forceps
21 cm



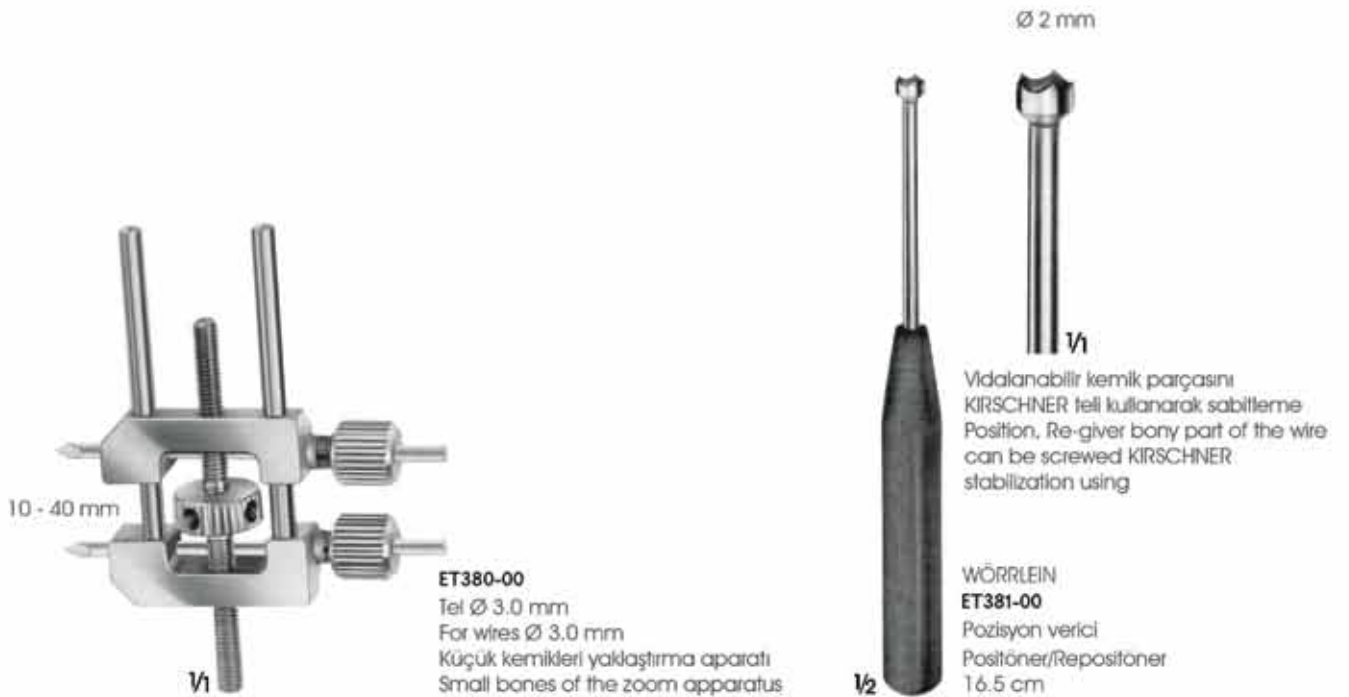
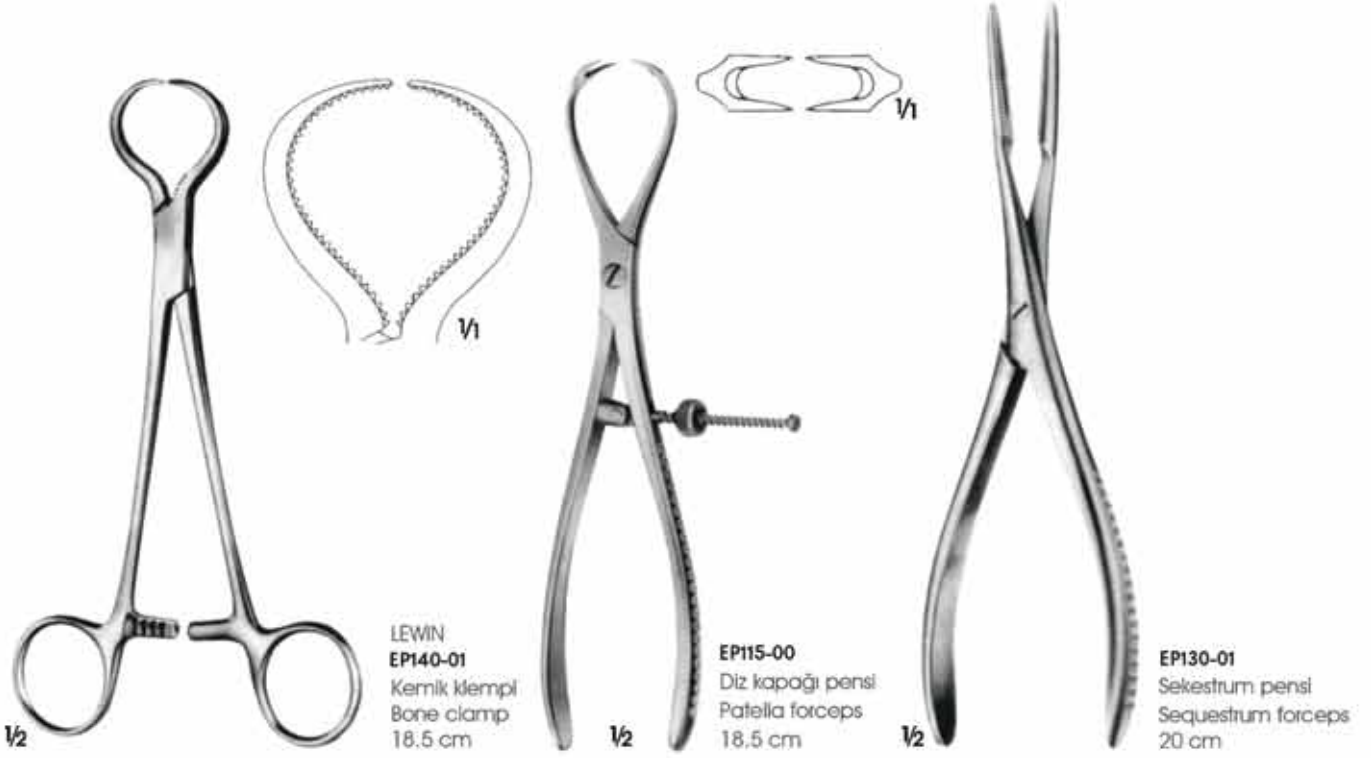



DINGMANN
EP125-00
18.5 cm

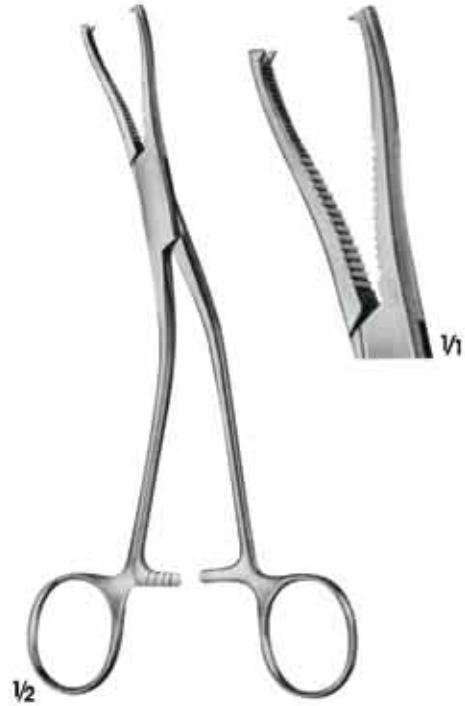

DINGMANN
EP126-00
18.5 cm



SEMB
EP135-00
19 cm



SEMB
EP136-00
19 cm





1/2
EP142-00
Kilitlenebilir, sabitlenebilir pens
Forceps with ratchet fixation
14 cm



1/2
EP143-00
Vida ile sabitlenebilir pens
Forceps with thread fixation
17 cm



1/2
EP143-01
Vida ile sabitlenebilir pens
Forceps with thread fixation
23.5 cm



1/2
EP150-00
Kemik tutma pens
Bone holding forceps
20 cm



1/2
LANGENBECK
EP151-00
Kemik tutma pens
Bone holding forceps
20.5 cm



1/2
FERGUSON
EP152-00
Kemik tutma pens
Bone holding forceps
20.5 cm

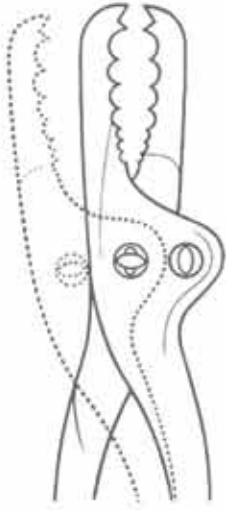

Ayarlanabilir ağız
Jaw adjustable



FARABEU
EP155-00
23cm



FARABEU
EP155-01
25.5 cm



FARABEU-LAMBOTTE
EP156-01
25.5 cm

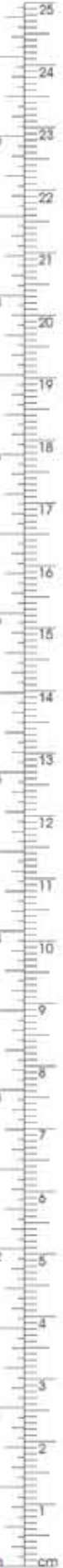







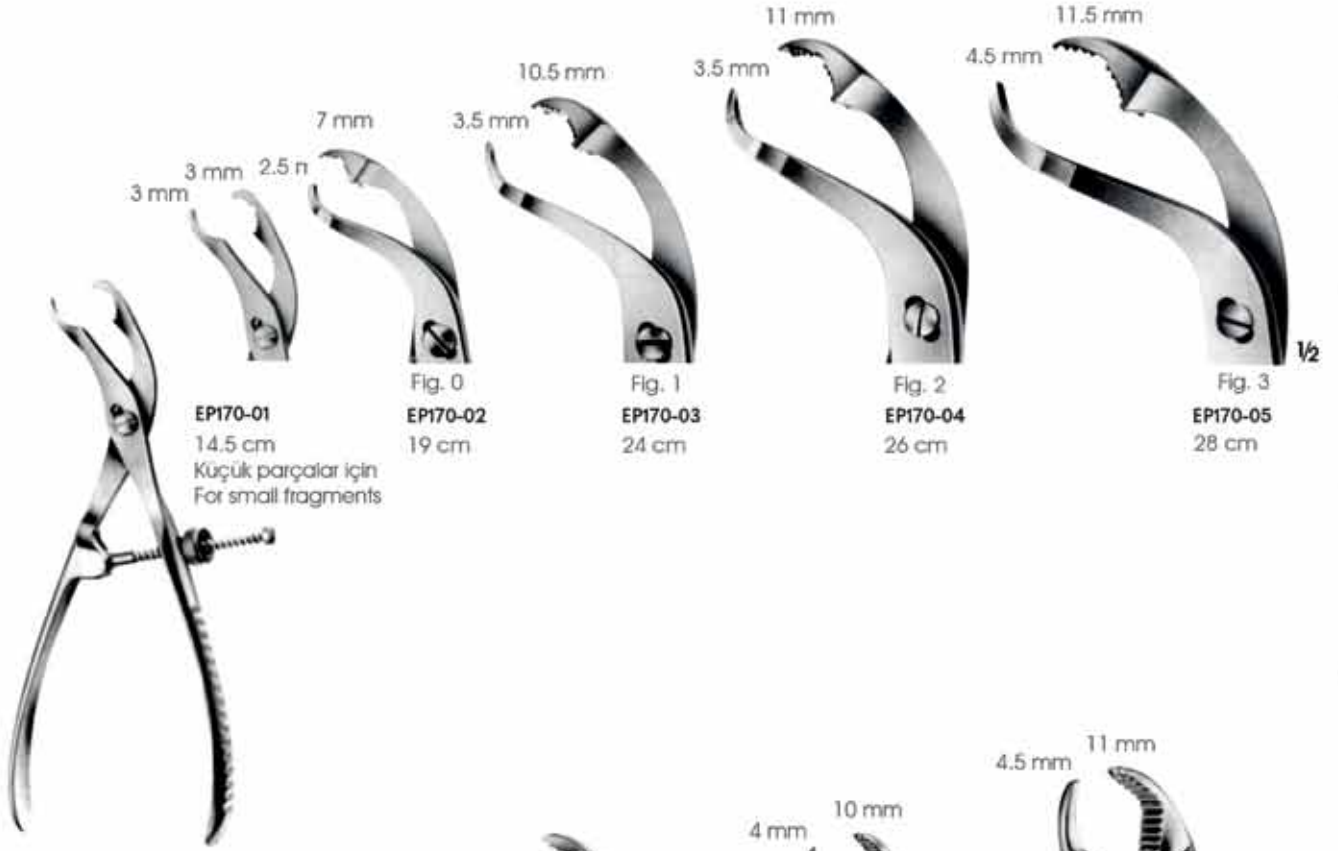

EP170-01
14.5 cm
Küçük parçalar için
For small fragments

Fig. 0
EP170-02
19 cm

Fig. 1
EP170-03
24 cm

Fig. 2
EP170-04
26 cm

Fig. 3
EP170-05
28 cm

EP170-01-EP170-05
Kendi kendini merkezleyici,
vidalı sabit pensler
Self-centering forceps with
thread fixation



VERBRUGGE
EP171-00
17.5 cm

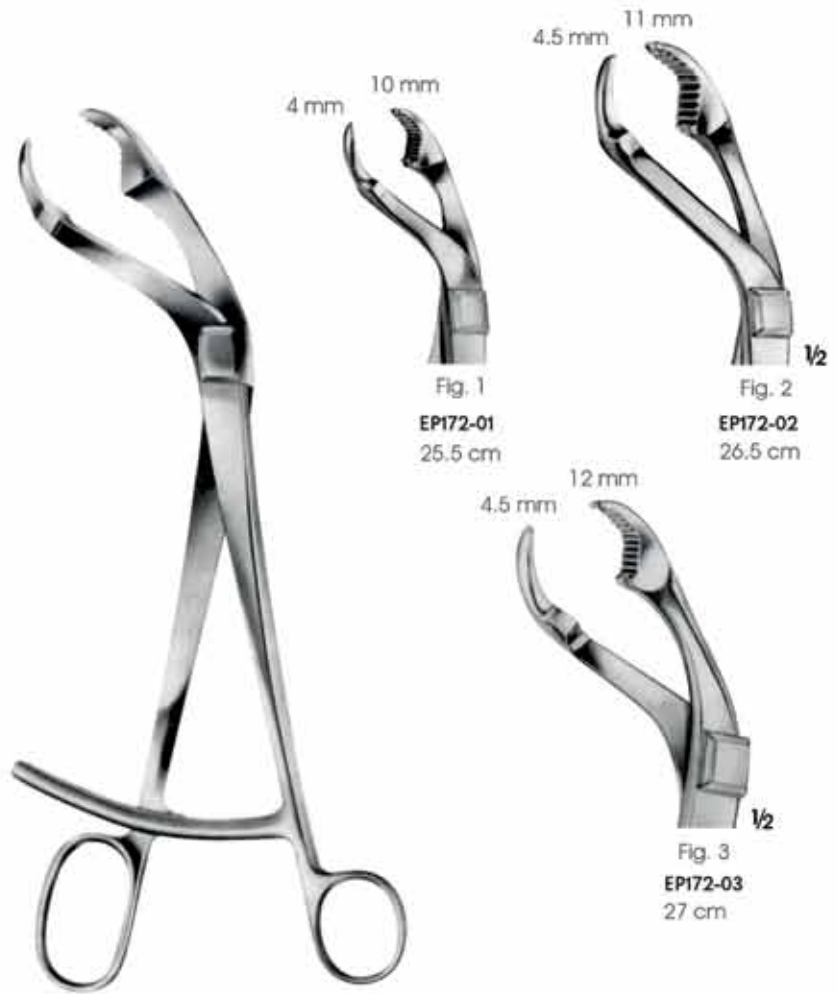

Fig. 1
EP172-01
25.5 cm

Fig. 2
EP172-02
26.5 cm

Fig. 3
EP172-03
27 cm

VERBRUGGE
EP172-01-EP172-03
Etkemli ağız/With lip joint

Haraketli çene
Movable jaw



EP176-01
22 cm



EP176-02
26 cm



EP176-03
33 cm

LAMBOTTE
EP176-01-EP176-03

Ayarlanabilir çene
Adjustable jaw



Haraketli çene
Movable jaw



EP177-00
21.5 cm

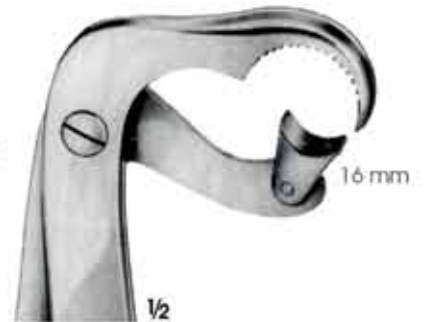

EP178-00
27.5 cm

EP177-00-EP178-00



LOWMAN
EP180-00 17 cm
EP180-01 20.5 cm



1/2
LOWMAN-GERSTER
EP180-02
21 cm



1/2
LOWMAN-HOGLUND
EP183-00
17.5 cm

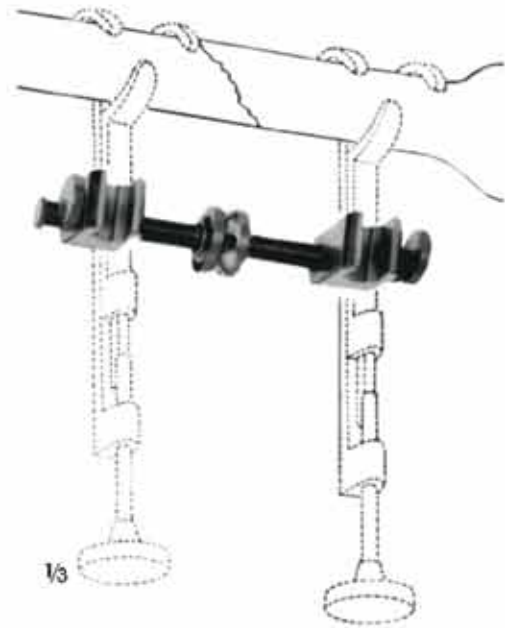

1/3
GERSTER
EP185-00
EP180-00-EP183-00 için çektime çubuğu
Traction bar for P EP180-00-EP183-00





EP251-01
Sinovektomi ronjur
Synovectomy rongeur
Çene genişliği 2.0 mm
Width of jaws 2.0 mm
13 cm



STELLBRINK
EP260-01
Sinovektomi ronjur
Synovectomy rongeur
17.5 cm



STELLBRINK
EP260-02
Sinovektomi ronjur
Synovectomy rongeur
17 cm

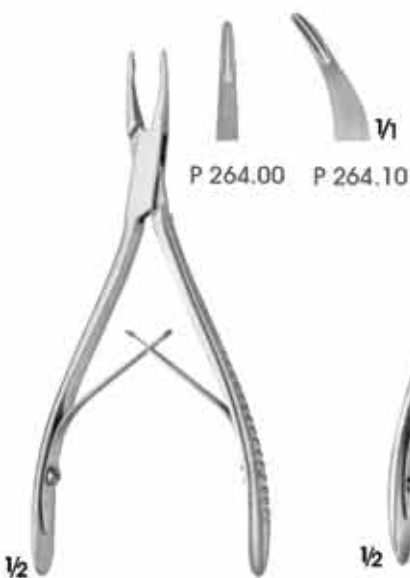

FRIEDMANN
EP264-00-EP264-10
Kemik Ronjur/Bone Rongeur
14 cm

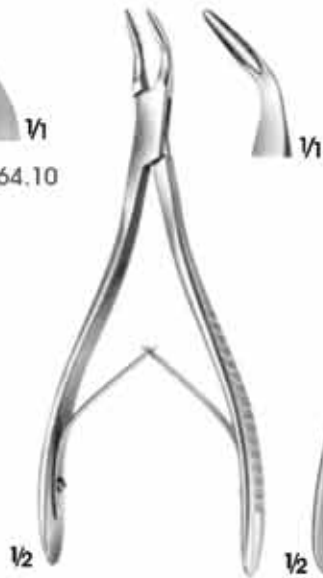

EP272-01
Kemik Ronjur/Bone Rongeur
15 cm

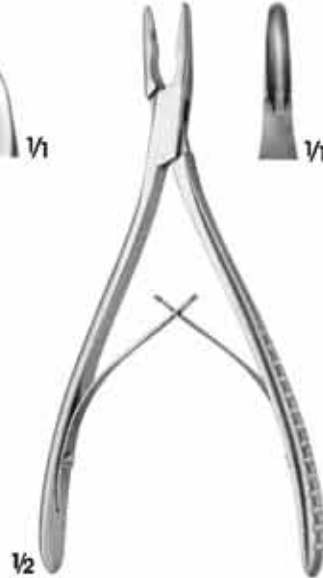

LEMBERT
EP274-01
Kemik Ronjur/Bone Rongeur
16.5 cm



SCHWARZ
EP292-01
Kemik Ronjur/Bone Rongeur
14.5 cm



1/2

LUER-FRIEDMANN
EP265-00

Kemik Ronjur/Bone Rongeur
14.5 cm



1/2

EP266-00
14 cm



1/2

LUER
EP267-00
15 cm



1/2

LUER
EP268-00
15.5 cm



1/2

BLUMENTHAL
EP270-00
15.5 cm



1/2

BLUMENTHAL
EP271-00
15 cm



Yana eğri
Curved to side

1/2

HAKANSSON
EP275-00
17 cm



1/2

MEAD
EP276-00
16.5 cm





JANSEN
EP277-00
17.5 cm



JANSEN
EP278-00
17.5 cm

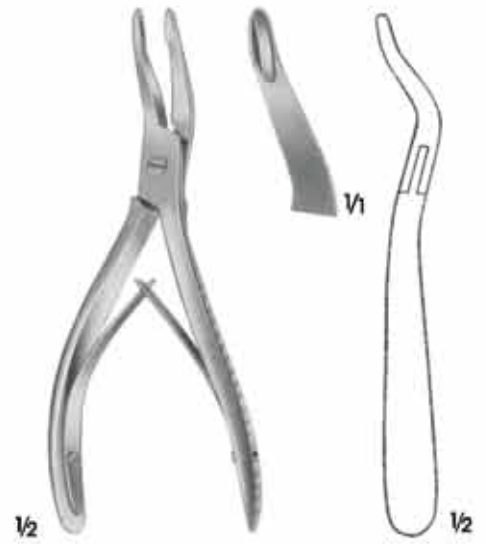

ALEXANDER
EP280-00
14 cm



LEMPERT
EP286-00-EP287-00
20 cm

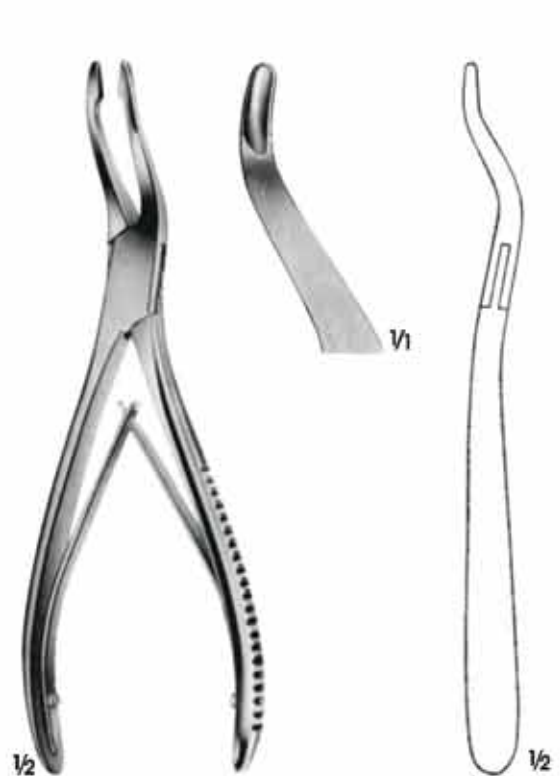

JANSEN
EP282-00
19 cm



BEYER
EP285-00
18 cm



LUER
EP290-00-EP291-00
17.5 cm



BANE-HARTMANN
EP279-00
17.5 cm



LUER
EP295-00
18 cm



LUER
EP296-00
18 cm





ADSON
EP323-01
20 cm



NORTHFIELD
EP329-01
21 cm



PENNYBACKER
EP327-01
20.5 cm



TROTTER
EP299-00
20.5 cm



GULEKE
EP298-00
20.5 cm



OLIVECRONA
EP297-00
20.5 cm

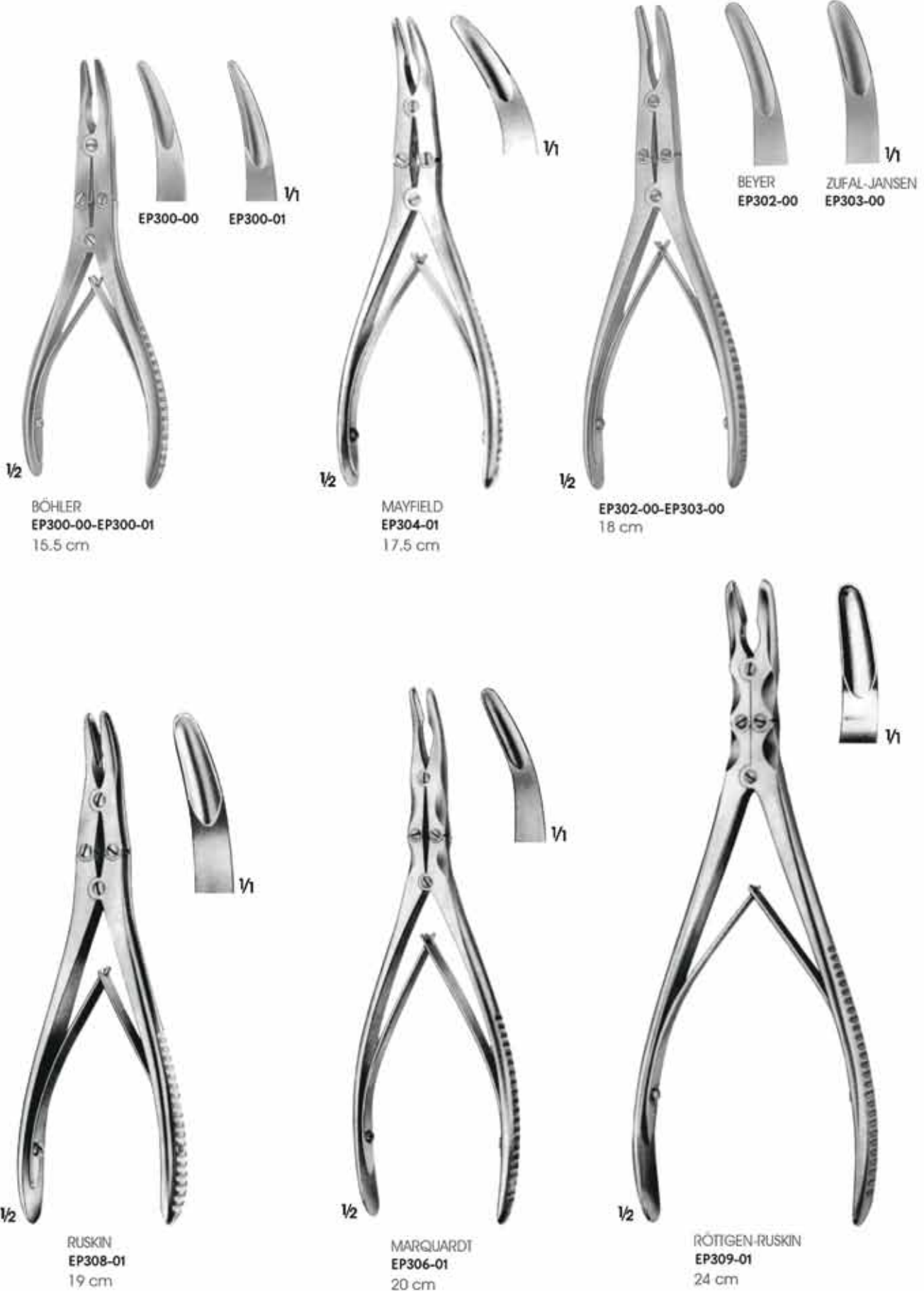

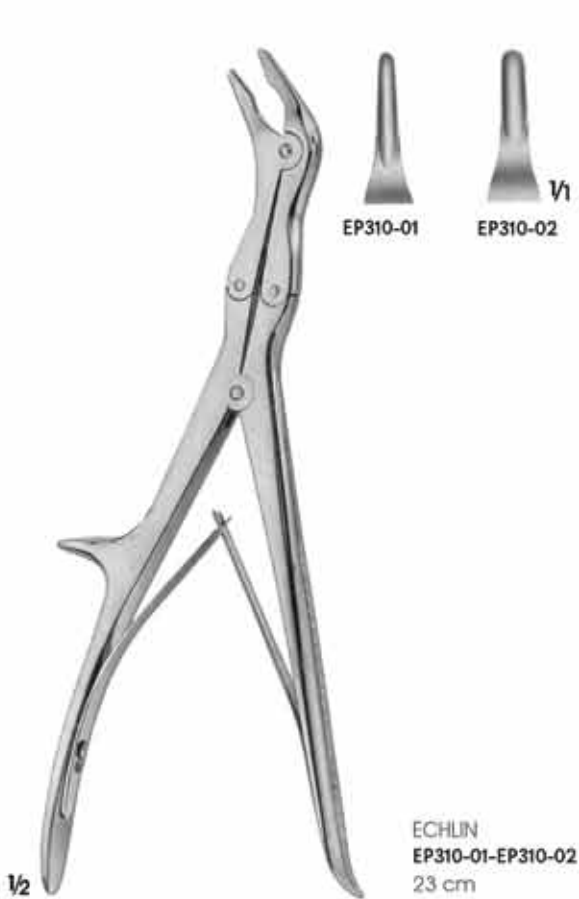



LEKSELL-STILLE
EP316-01
24 cm



STILLE-RUSKIN
EP318-01
24 cm



LUER-STILLE
EP320-01
22.5 cm



LUER-STILLE
EP321-01
22.5 cm

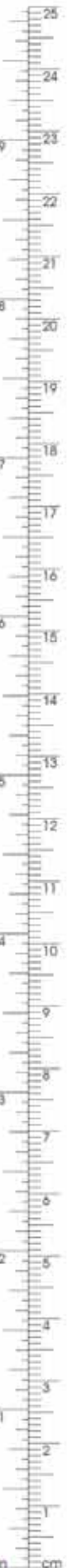



SEMB
EP325-01
24 cm



LUER-STILLE
EP325-01
27 cm



SAUERBRUCH-CORYLLOS
EP333-01-EP335-01
31 cm



SYPERT
EP338-02
36 cm



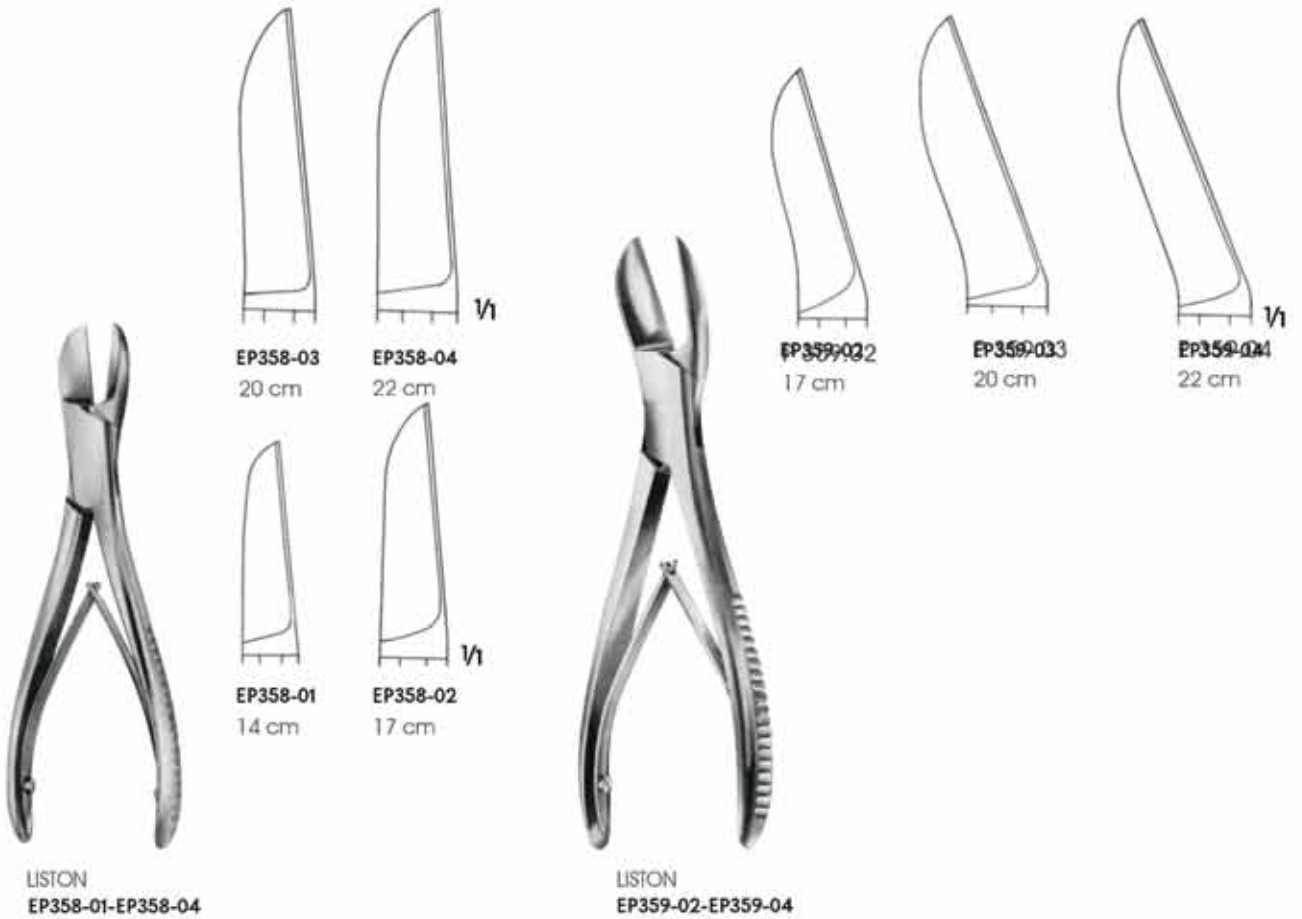
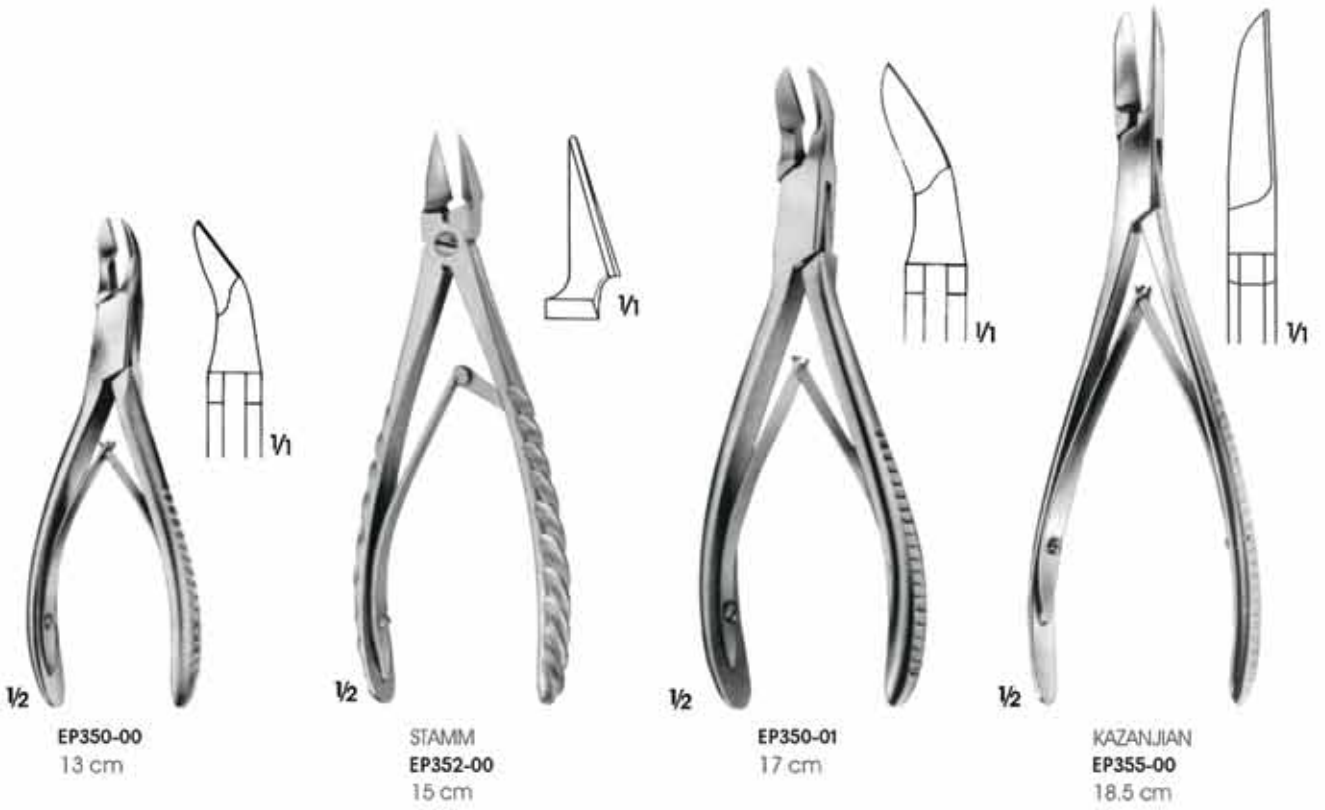



BÖHLER
EP365-00
14.5 cm



BÖHLER
EP366-00
14.5 cm



EP367-00
17 cm



MC INDOE
EP368-00
17.5 cm



RUSKIN-LISTON
EP370-00
19 cm



RUSKIN-LISTON
EP371-00
19 cm



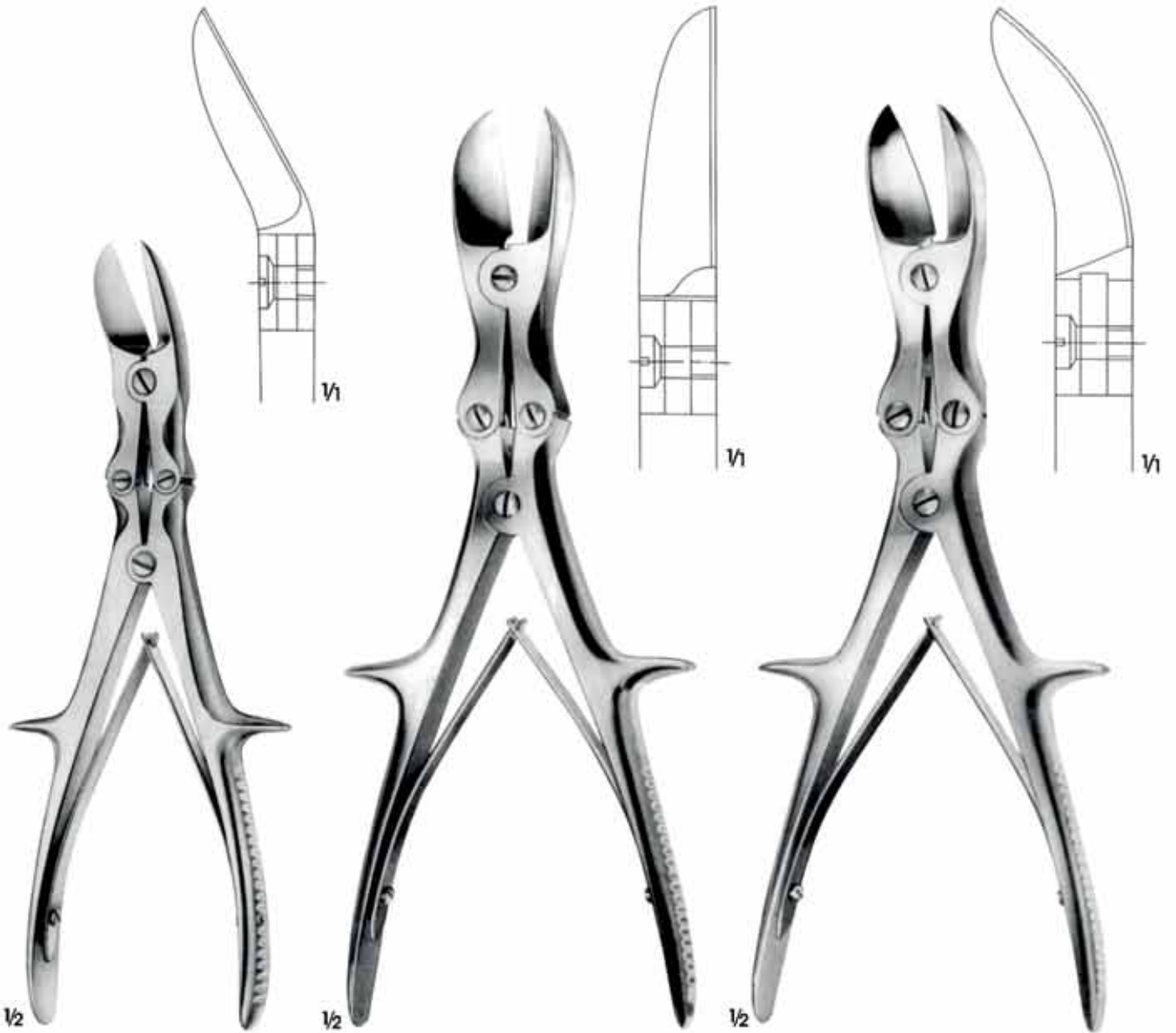

**LISTON
EP375-01**
Düz eğimli/Curved on flat
24 cm

**LISTON
EP376-01**
Düz/Straight
28 cm

**LISTON
EP377-01**
Düz eğimli/Curved on flat
28 cm

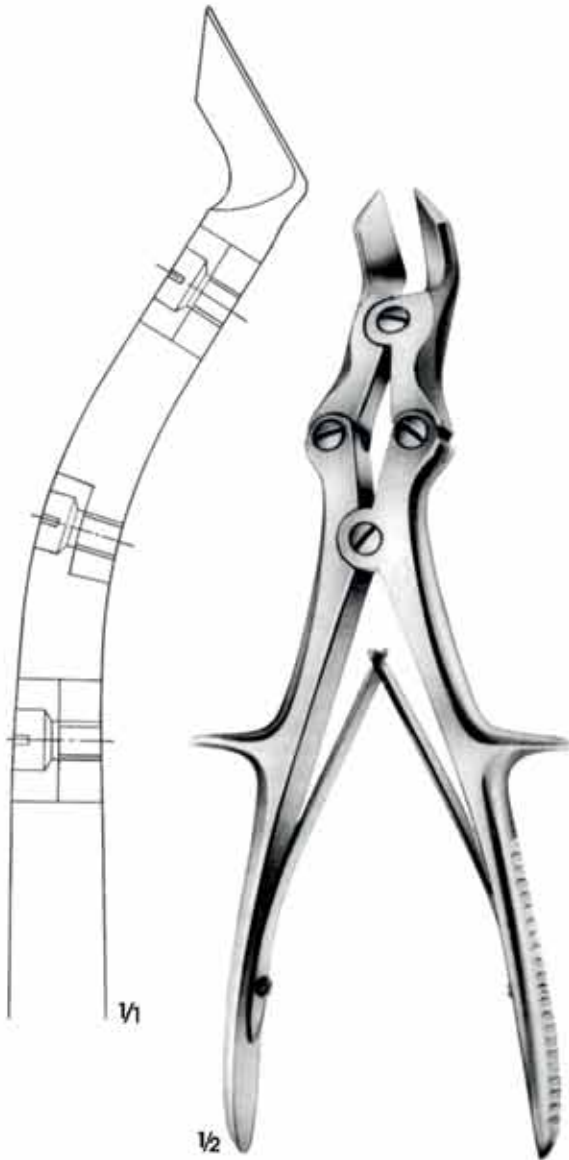

LISTON-KEY-HORSLEY
EP379-01
25.5 cm

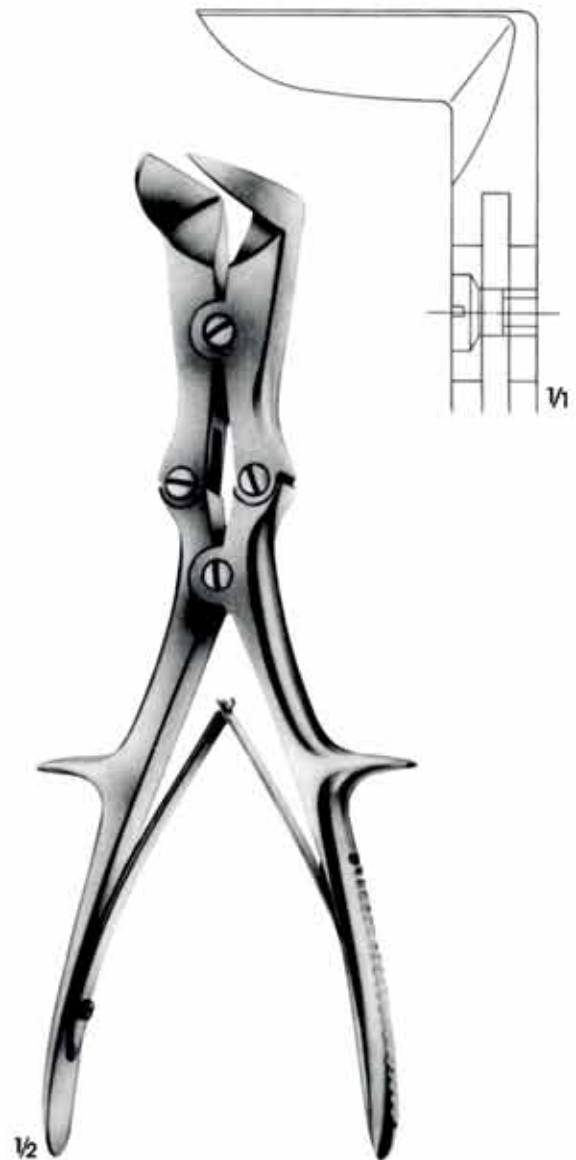

LISTON-STILLE
EP378-01
26.5 cm



Pançlar için açılı pozisyonlar
Angled positions for punches

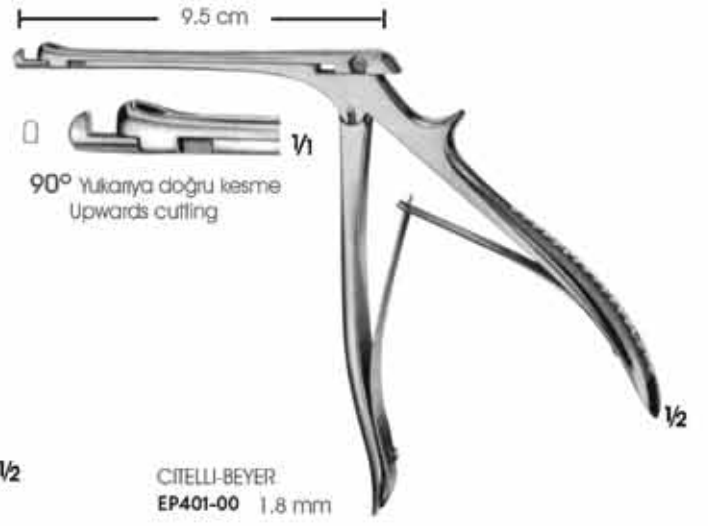
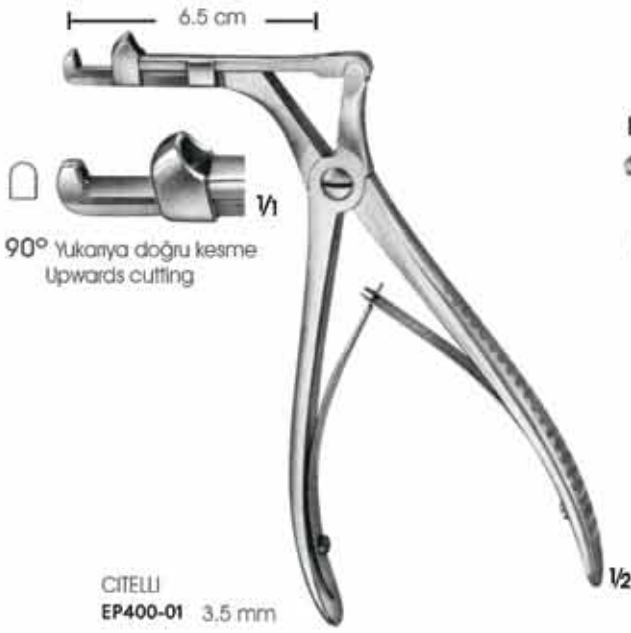
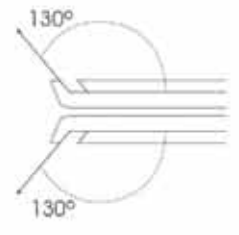
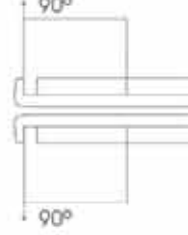
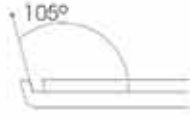

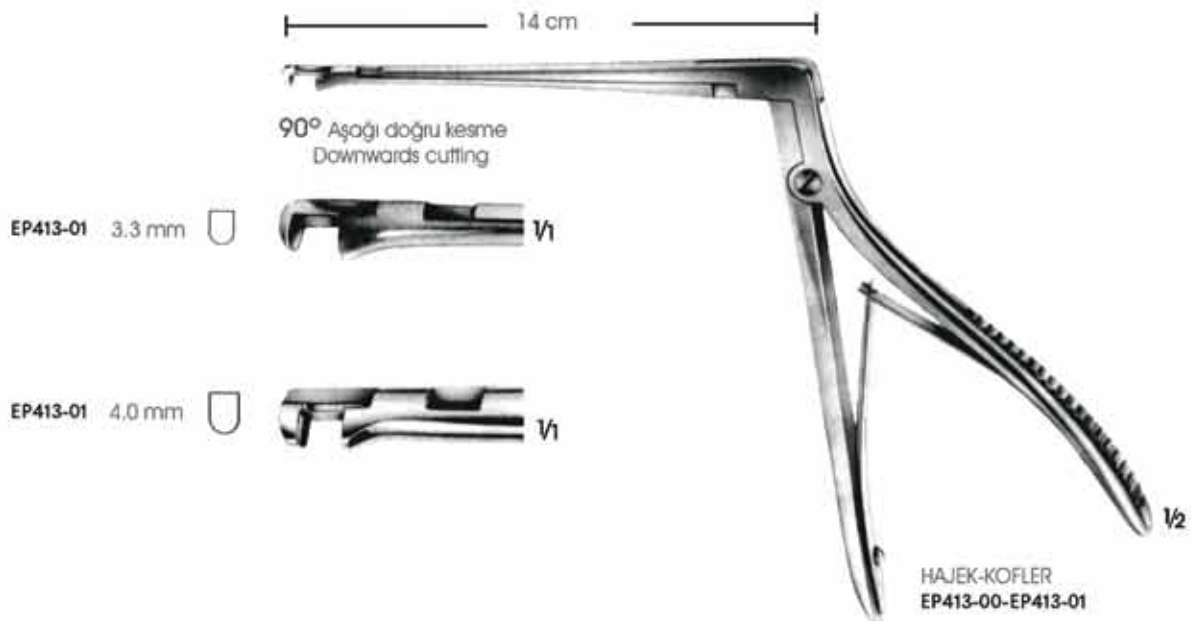
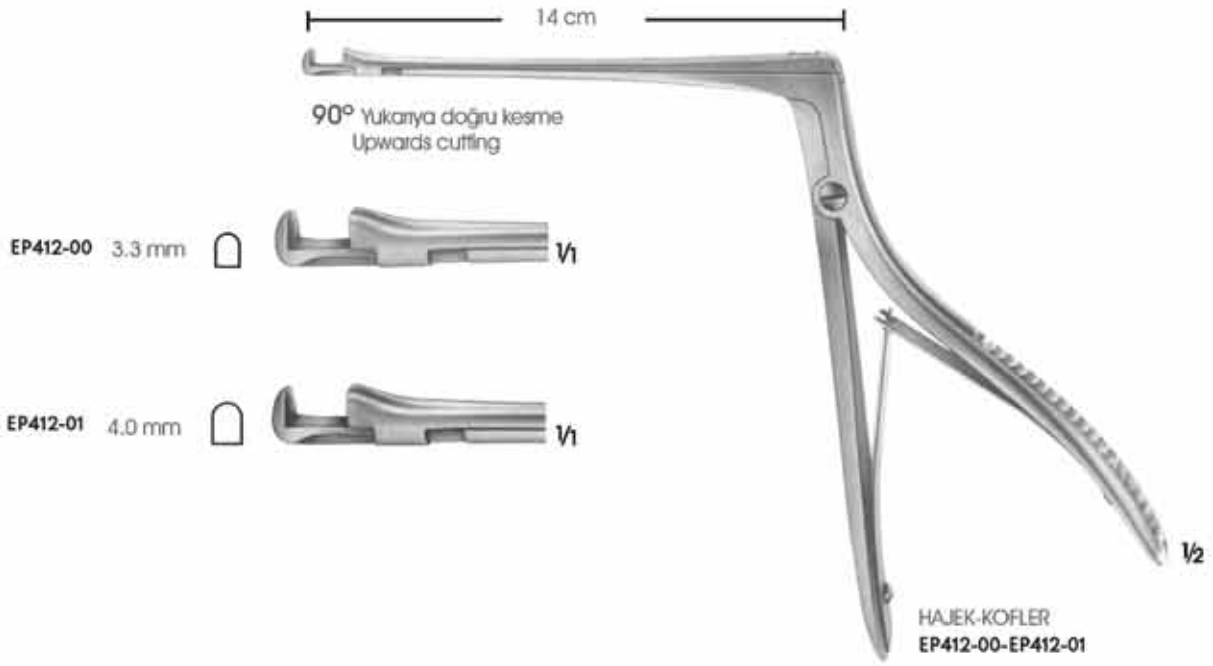

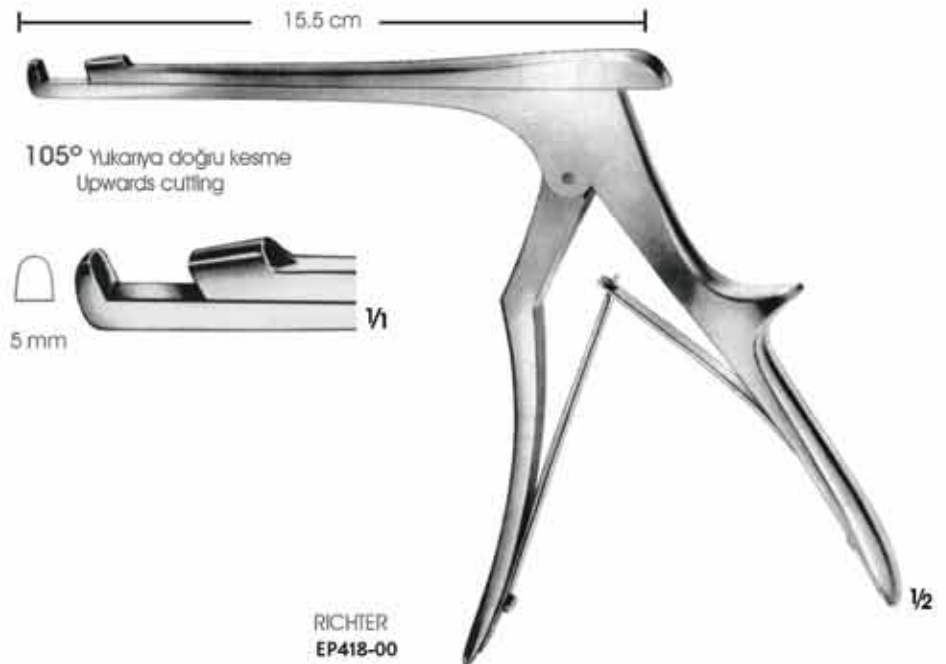
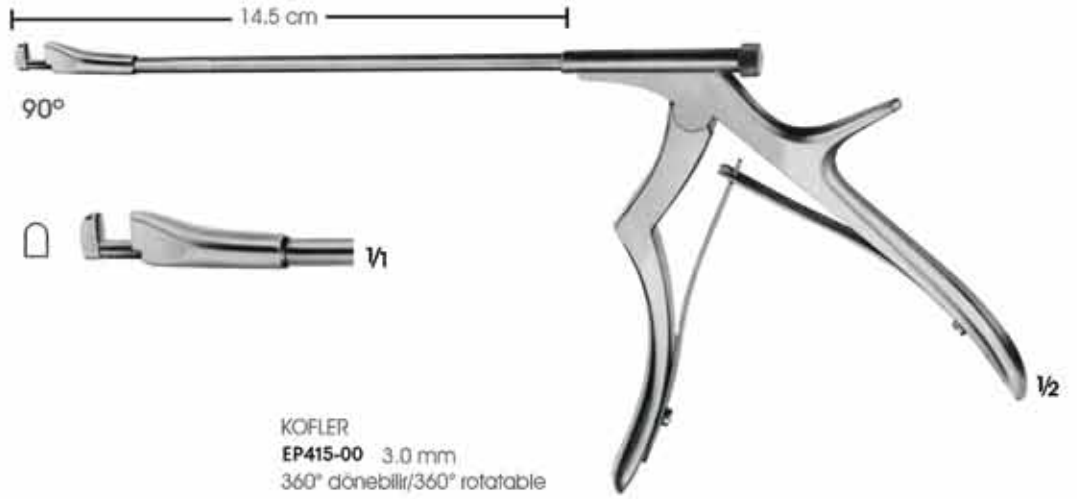
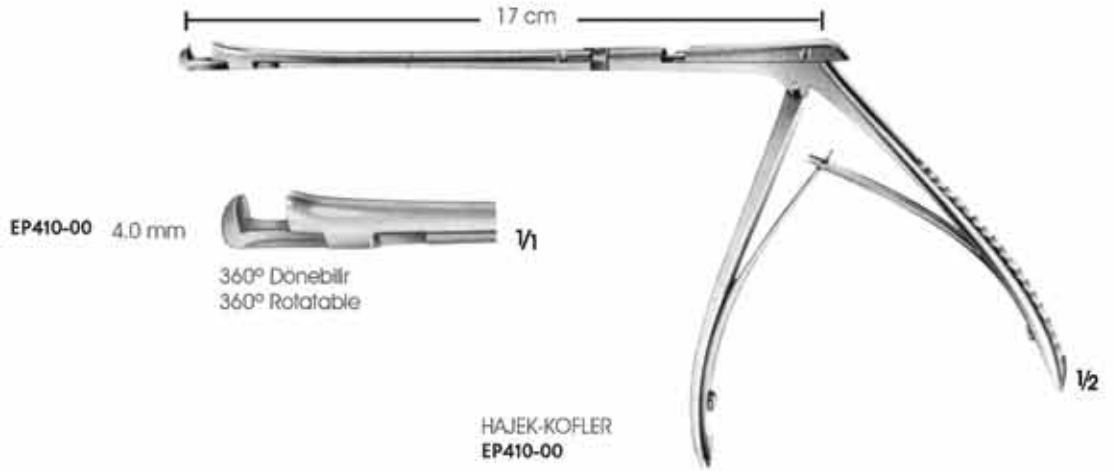

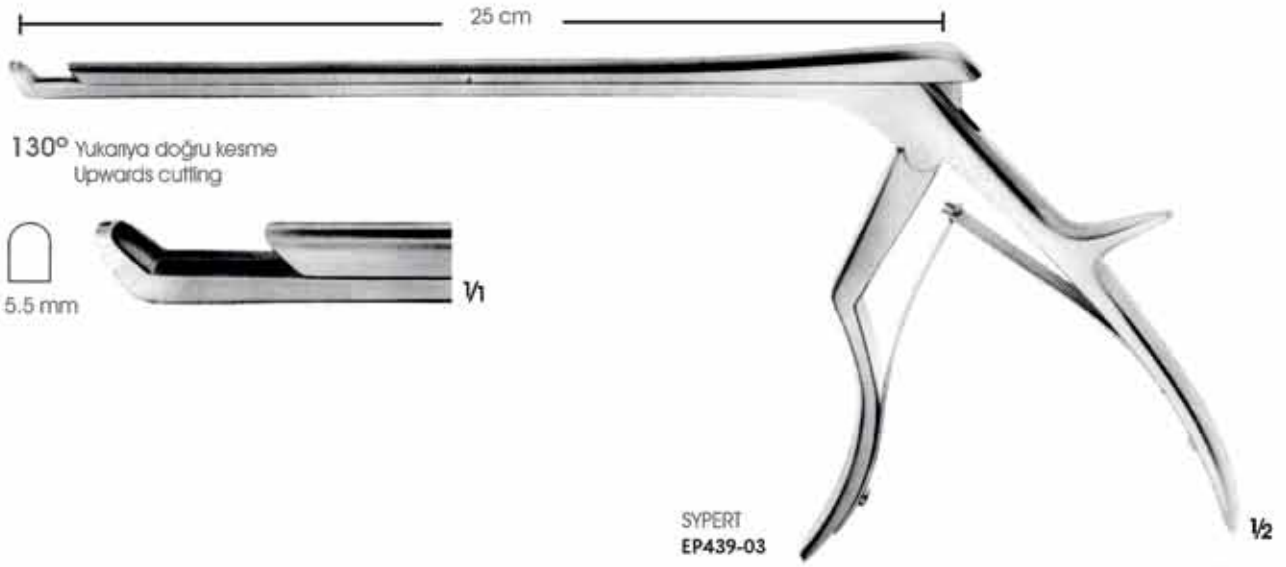

130° Yukarıya doğru kesme/Upwards cutting



Boy Length	En Width	Ejektör Ejector	Ayrılabilir/Detachable				
18 cm	1 mm	□	-	EP709-01	EP750-01	EP709-01B	EP750-01B
18 cm	2 mm	□	+	EP709-02	EP750-02	EP709-02B	EP750-02B
18 cm	3 mm	□	+	EP709-03	EP750-03	EP709-03B	EP750-03B
18 cm	4 mm	□	+	EP709-04	EP750-04	EP709-04B	EP750-04B
18 cm	5 mm	□	+	EP709-05	EP750-05	EP709-05B	EP750-05B
18 cm	6 mm	□	+	EP709-06		EP709-06B	
20 cm	1 mm	□	-		EP752-01		EP752-01B
20 cm	2 mm	□	+	EP710-02	EP752-02	EP710-02B	EP752-02B
20 cm	3 mm	□	+	EP710-03	EP752-03	EP710-03B	EP752-03B
20 cm	4 mm	□	+	EP710-04	EP752-04	EP710-04B	EP752-04B
20 cm	5 mm	□	+	EP710-05	EP752-05	EP710-05B	EP752-05B
20 cm	6 mm	□	+	EP710-06		EP710-06B	
23 cm	2 mm	□	+	EP172-02	EP754-02	EP712-02B	EP754-02B
23 cm	3 mm	□	+	EP172-03	EP754-03	EP712-03B	EP754-03B
23 cm	4 mm	□	+	EP172-04	EP754-04	EP712-04B	EP754-04B
23 cm	5 mm	□	+	EP172-05	EP754-05	EP712-05B	EP754-05B

90° Yukarıya doğru kesme/Upwards cutting



Standart ağız tabanlı
Standard footplate

HARD COATED



Standart ağız tabanlı
Standard footplate



Standart ağız tabanlı
Standard footplate

Ayrılabilir/Detachable



Standart/Standard



Boy Length	En Width	Ejektör Ejector			
18 cm	1 mm	□	-	EP701-01	EP710-01B
18 cm	2 mm	□	+	EP701-02	EP710-02B
18 cm	3 mm	□	+	EP701-03	EP710-03B
18 cm	4 mm	□	+	EP701-04	EP710-04B
18 cm	5 mm	□	+	EP701-05	EP710-05B
18 cm	6 mm	□	+	EP701-06	EP710-06B
23 cm	2 mm	□	+	EP703-02	
23 cm	3 mm	□	+	EP703-03	
23 cm	4 mm	□	+	EP703-04	
23 cm	5 mm	□	+	EP703-05	

90° Aşağıya doğru kesme/Downwards cutting

Ayrılabilir/Detachable



Standart/Standard



Boy Length	En Width	Ejektör Ejector			
18 cm	1 mm	□	-	EP705-01	EP433-00
18 cm	2 mm	□	+	EP705-02	EP433-01
18 cm	3 mm	□	+	EP705-03	EP433-02
18 cm	4 mm	□	+	EP705-04	EP433-03
18 cm	5 mm	□	+	EP705-05	EP433-04
18 cm	6 mm	□	+	EP705-06	EP433-05
23 cm	2 mm	□	+	EP702-02	
23 cm	3 mm	□	+	EP707-03	
23 cm	4 mm	□	+	EP707-04	
23 cm	5 mm	□	+	EP707-05	



130° Aşağıya doğru kesme/Downwards cutting



Standart ağız tabanlı
Standard footplate

İnce ağız tabanlı
With thin footplate

Standart ağız tabanlı
Standard footplate

İnce ağız tabanlı
With thin footplate

Ayrılabilir/Detachable

Standart/Standard

Boy
Length

En
Width

Ejektör
Ejector



18 cm

1 mm



-

EP714-01

EP757-01

EP432-00

EP435-00

18 cm

2 mm



-

EP714-02

EP757-02

EP432-01

EP435-01

18 cm

3 mm



+

EP714-03

EP757-03

EP432-02

EP435-02

18 cm

4 mm



+

EP714-04

EP757-04

EP432-03

EP435-03

18 cm

5 mm



+

EP714-05

EP757-05

EP432-04

EP435-04

21.5 cm

2 mm



-

EP437-01

21.5 cm

3 mm



-

EP437-02

21.5 cm

4 mm



+

EP437-03

21.5 cm

5 mm



+

EP437-04

23 cm

2 mm



-

EP717-02

EP453-02

23 cm

3 mm



+

EP717-03

EP453-03

23 cm

4 mm



+

EP717-04

EP453-04

23 cm

5 mm



+

EP717-05

EP453-05

130° Yukarıya doğru kesme/Upwards cutting



Standart ağız tabanlığı
Standard footplate



İnce ağız tabanlığı
With thin footplate

Standart/Standard

Boy Length	En Width			
18 cm	1 mm		EP430-00	EP434-00
18 cm	2 mm		EP430-01	EP434-01
18 cm	3 mm		EP430-02	EP434-02
18 cm	4 mm		EP430-03	EP434-03
18 cm	5 mm		EP430-04	EP434-04
18 cm	6 mm		EP430-05	
20 cm	1 mm			EP441-01
20 cm	2 mm		EP438-01	EP441-02
20 cm	3 mm		EP438-02	EP441-03
20 cm	4 mm		EP438-03	EP441-04
20 cm	5 mm		EP438-04	EP441-05
20 cm	6 mm		EP438-05	
21.5 cm	2 mm		EP436-01	
21.5 cm	3 mm		EP436-02	
21.5 cm	4 mm		EP436-03	
21.5 cm	5 mm		EP436-04	
23 cm	2 mm		EP452-02	EP449-02
23 cm	3 mm		EP452-03	EP449-03
23 cm	4 mm		EP452-04	EP449-04
23 cm	5 mm		EP452-05	EP449-05



ER

Ronjurlar
Rongeurs



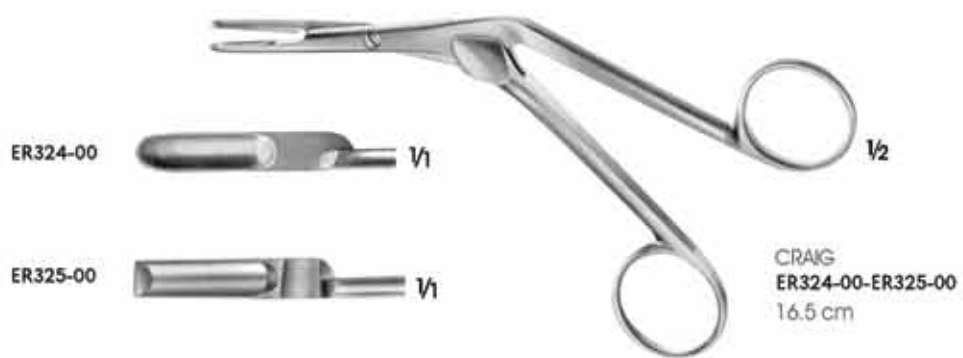
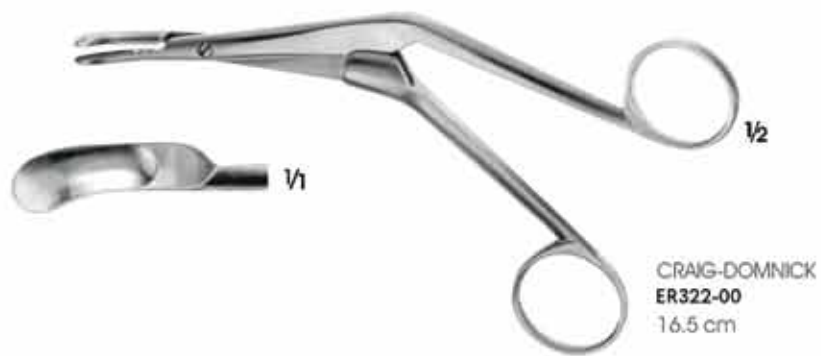

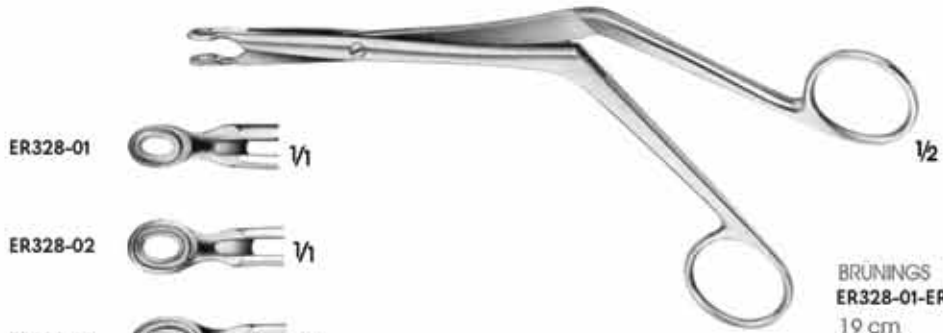
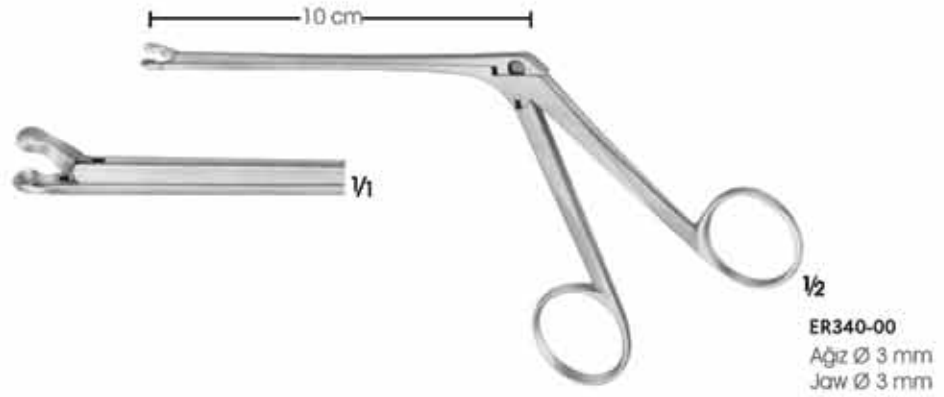

ER328-01 V1

ER328-02 V1

ER328-03 V1

ER328-04 V1

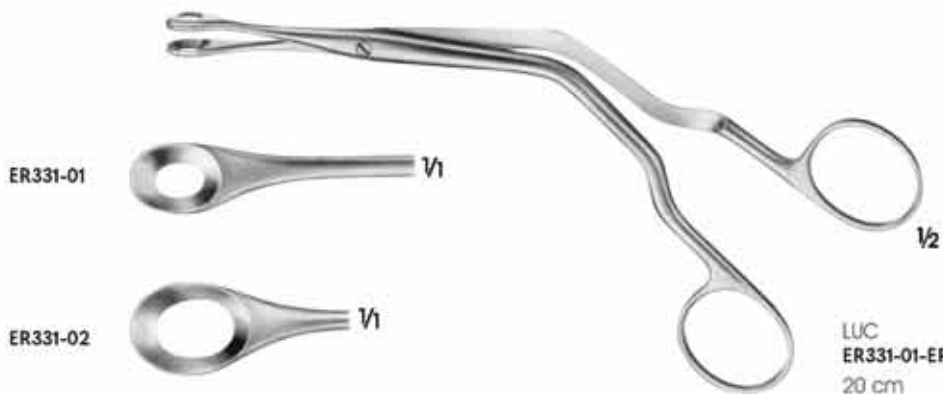

ER331-01 V1

ER331-02 V1



Pançlar için açılı pozisyonlar
Angled positions for punches

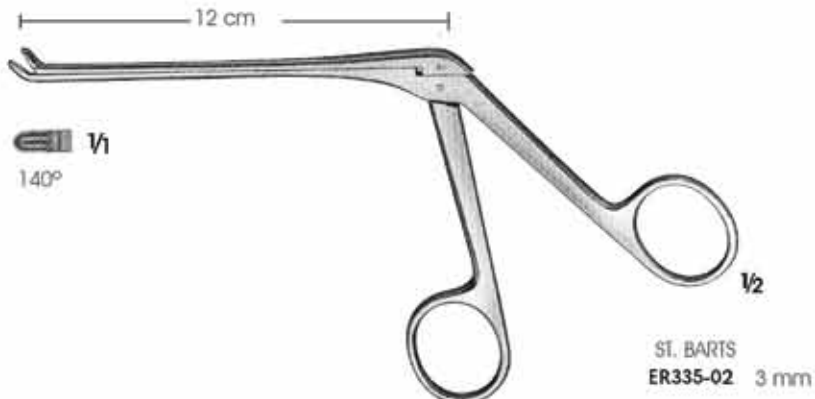
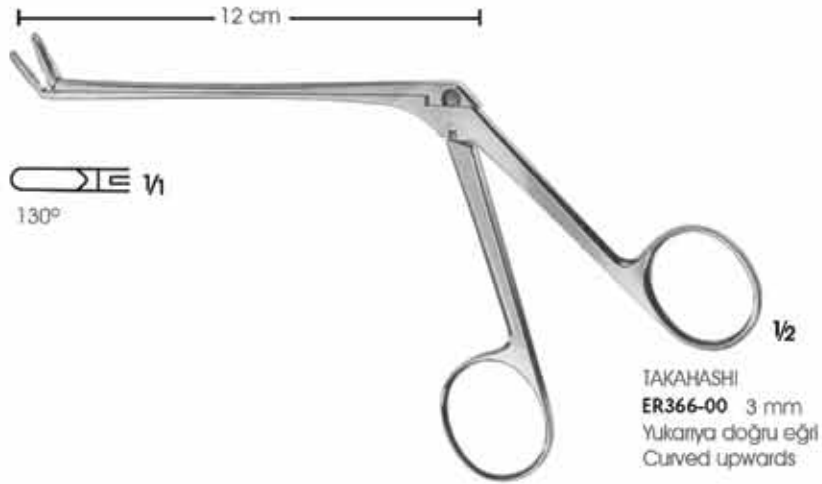
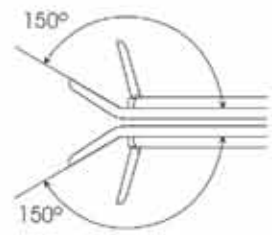
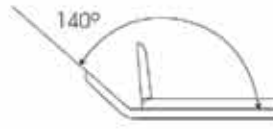
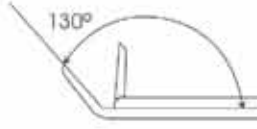

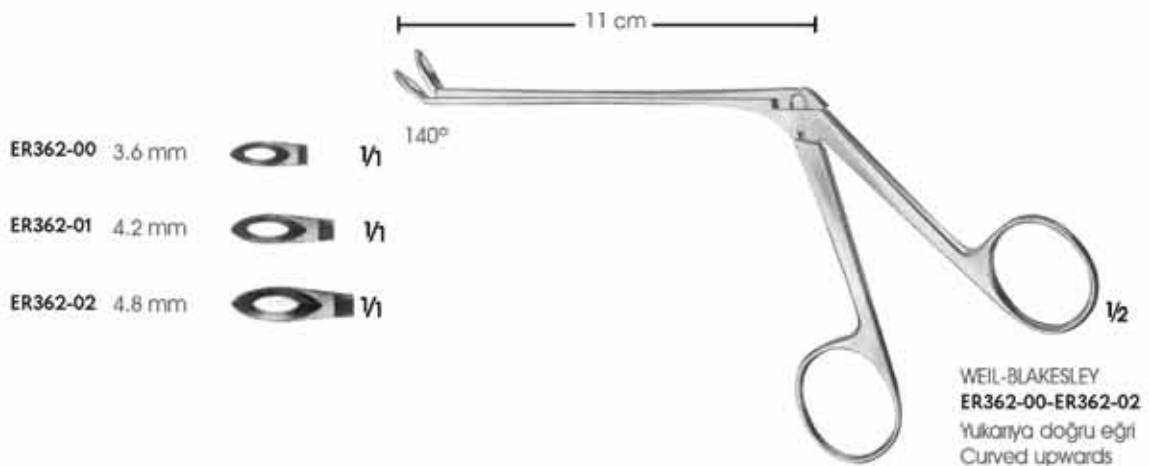
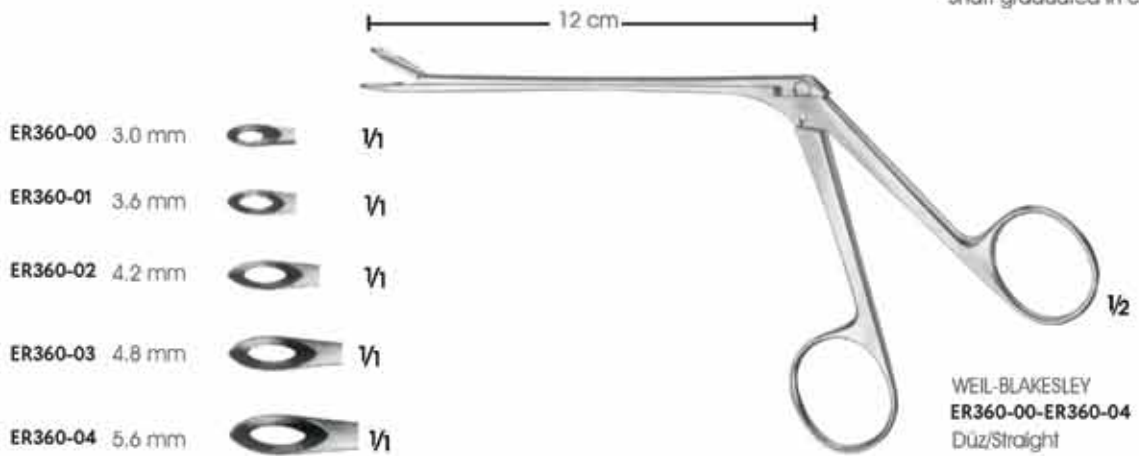
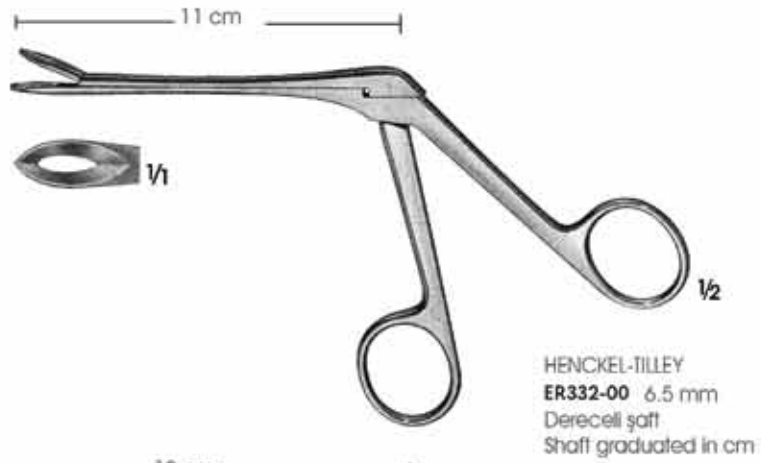

12 cm



ST. BARTS
ER335-01 3 mm

14 cm



BECK
ER420-01 2 mm

13 cm



PENNYBACKER
ER428-01 3 mm

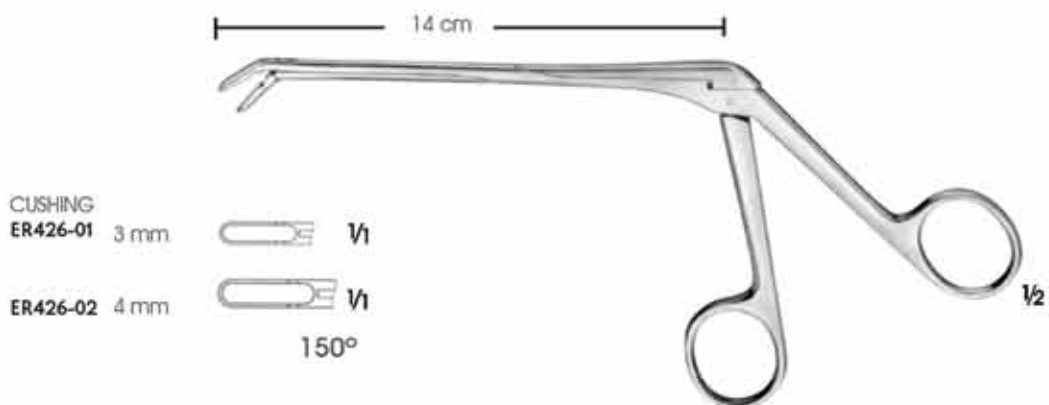
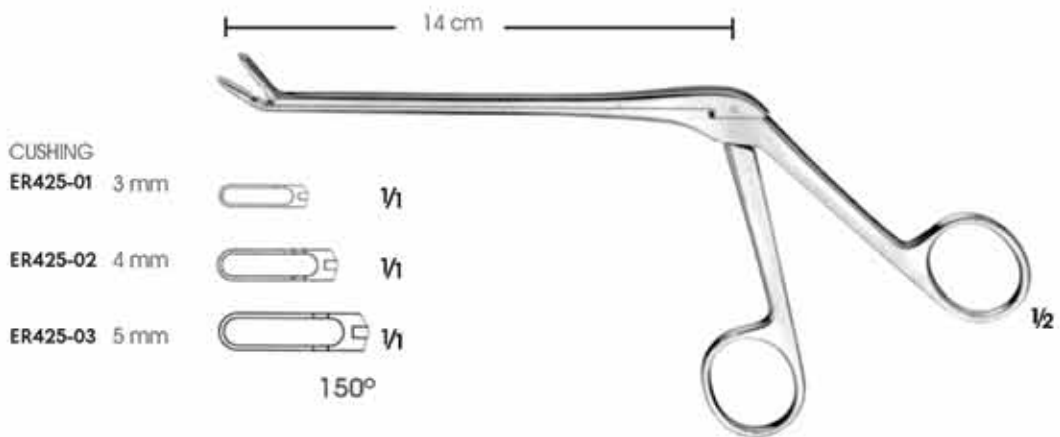
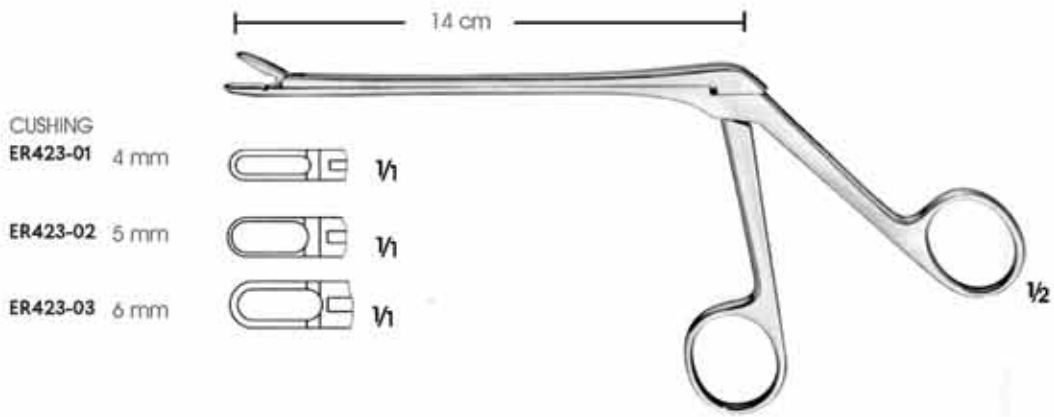

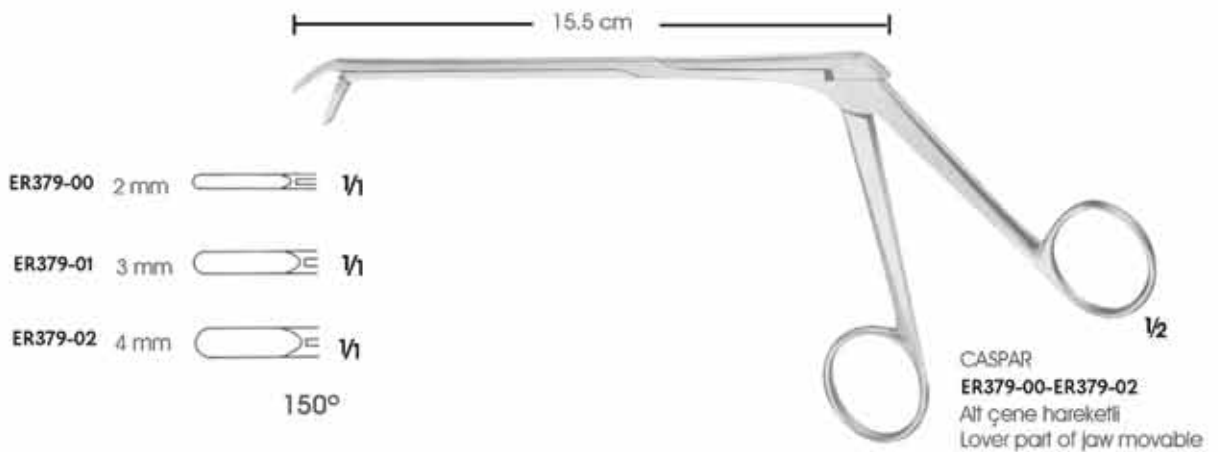
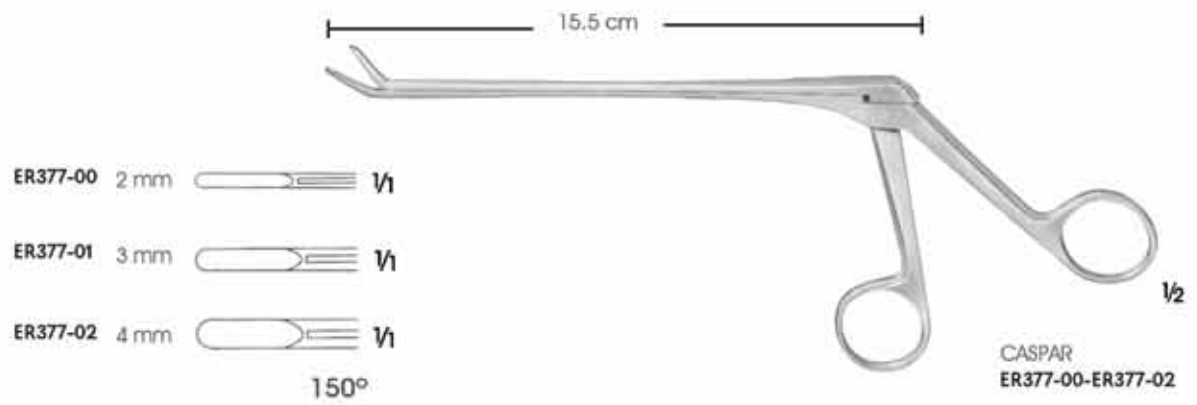
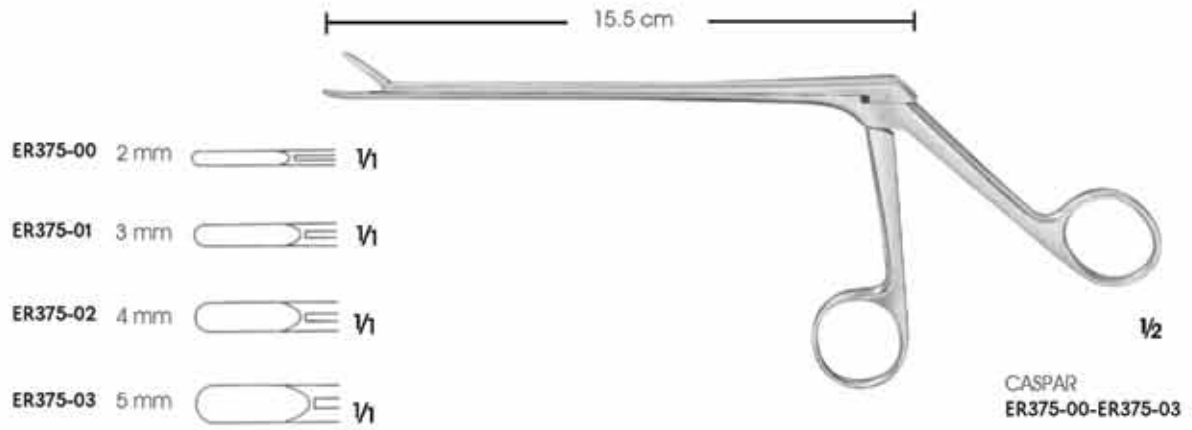

LOVE-GRUENWALD
ER370-00 2 x 10 mm



LOVE-GRUENWALD
ER370-01 3 x 10 mm



SPURLING
ER370-02 4 x 10 mm



CUSHING
ER380-00 2 x 10 mm



LOVE-GRUENWALD
ER383-01 3 x 10 mm



SPURLING
ER386-02 4 x 10 mm



LOVE-GRUENWALD
ER384-01 3 x 10 mm



SPURLING
ER387-02 4 x 10 mm

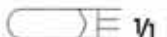

150°



Üst çene hareketli
Upper part of jaw movable

LOVE-GRUENWALD
ER385-01 3 x 10 mm

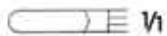

LOVE-GRUENWALD
ER388-02 4 x 10 mm

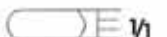

150°



OLDBERG
ER410-00 Ø 7 mm

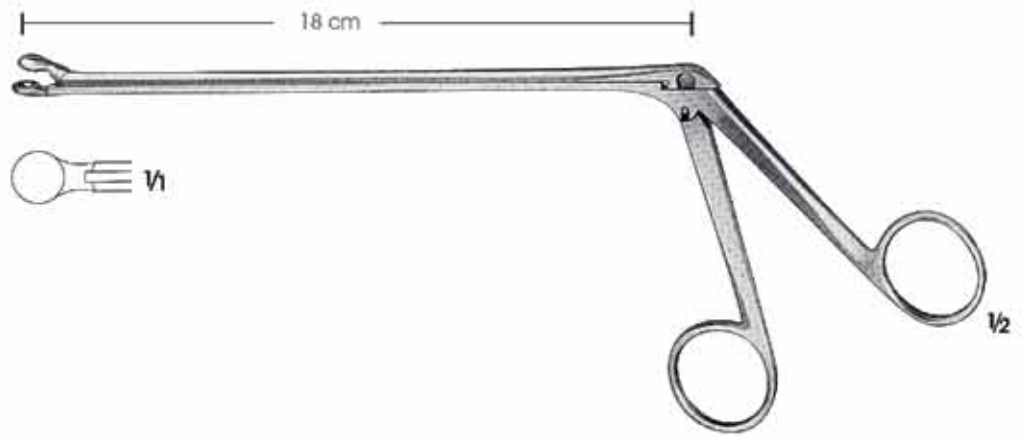

YASARGIL
ER412-00 Ø 2.2 mm

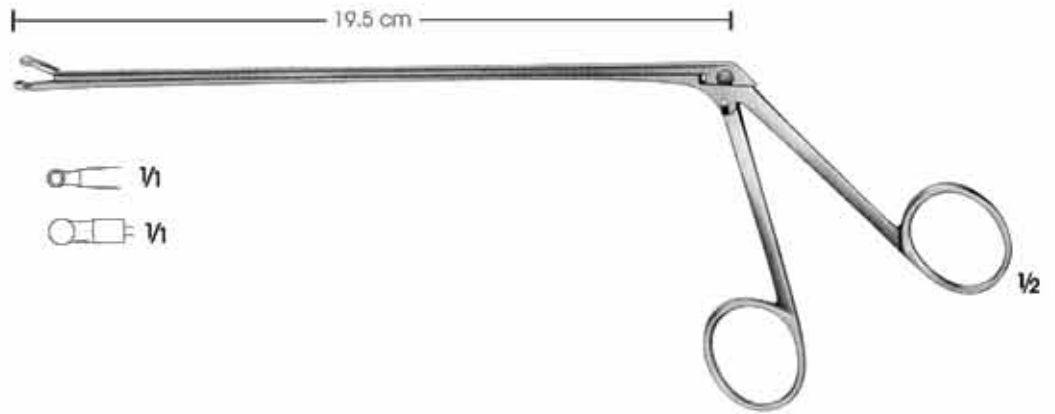

ER412-01 Ø 3.5 mm

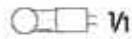

LANDOLT
ER415-00 Ø 9 mm
Grasping tümör penssi, künt
Tumor grasping forceps, blunt

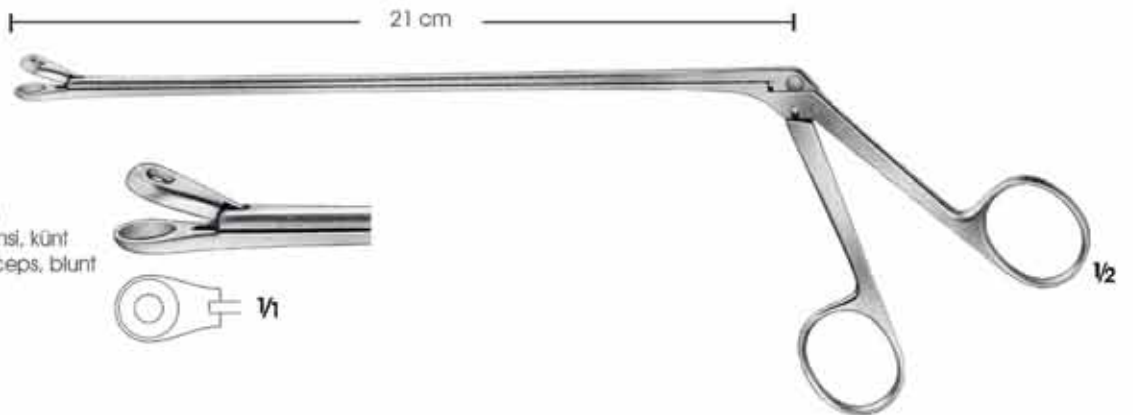

KRAMER
ER417-01 2.5 x 10 mm
Derinlik koruyuculu
With depth guard





Mil uzunluğu
Length of shaft
14 cm

ER390-00

ER390-01

ER390-02

ER390-03

ER390-04

Mil uzunluğu
Length of shaft
16 cm

ER390-05

ER390-06

ER390-07

ER390-08

ER390-09

Mil uzunluğu
Length of shaft
18.5 cm

ER390-10

ER390-11

ER390-12

ER390-13

ER390-14

Çene ölçüleri
Size of jaws

2 x 12 mm



3 x 12 mm



4 x 14 mm



5 x 14 mm



6 x 16 mm



Mil uzunluğu
Length of shaft



CASPAR
ER390-00-ER390-14

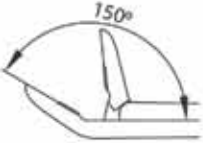

Mil uzunluğu
Length of shaft
14 cm

ER392-01

ER392-02

ER392-03

Mil uzunluğu
Length of shaft
16 cm

ER392-06

ER392-07

ER392-08

Mil uzunluğu
Length of shaft
18.5 cm

ER392-11

ER392-12

ER392-13

Çene ölçüleri
Size of jaws

3 x 12 mm



4 x 14 mm



5 x 14 mm



Mil uzunluğu
Length of shaft

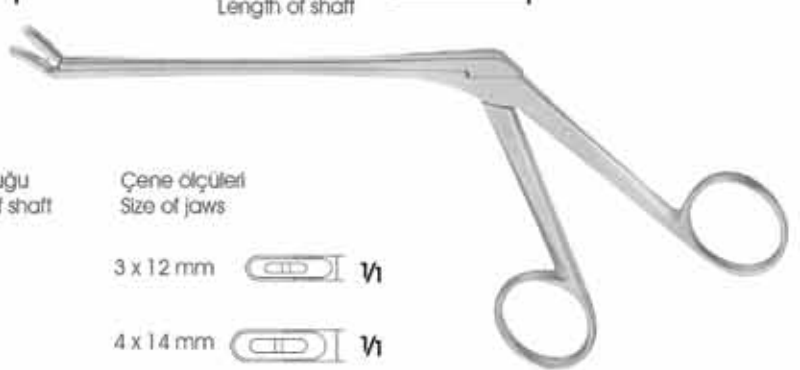

CASPAR
ER392-01-ER392-13

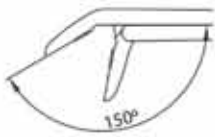

Mil uzunluğu
Length of shaft
14 cm

ER394-01

ER394-02

Mil uzunluğu
Length of shaft
16 cm

ER394-06

ER394-07

Mil uzunluğu
Length of shaft
18.5 cm

ER394-11

ER394-12

Çene Ölçüleri
Size of jaws

3 x 12 mm



4 x 14 mm



Mil uzunluğu
Length of shaft



Alt çene hareketli
Upper part of jaw movable

CASPAR
ER394-01-ER394-12



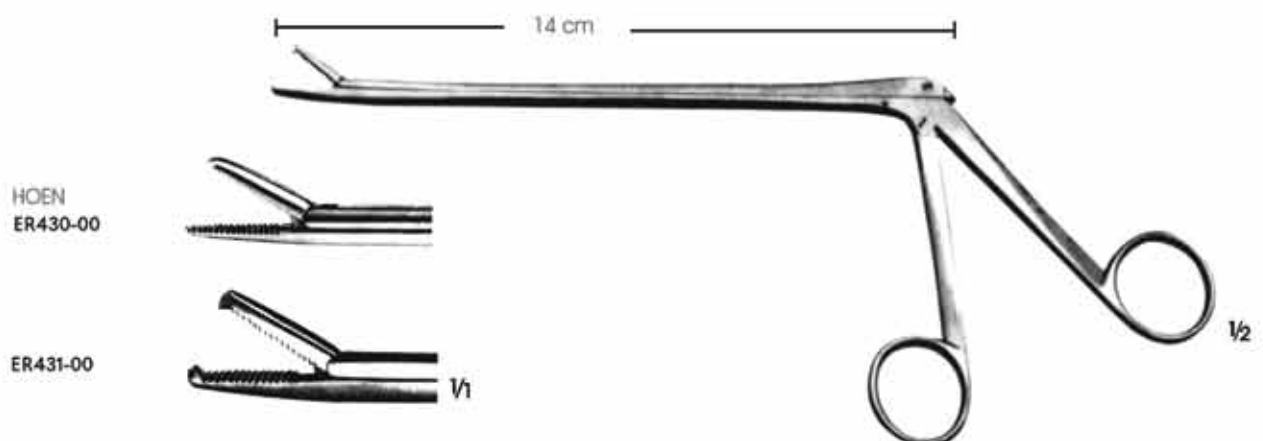
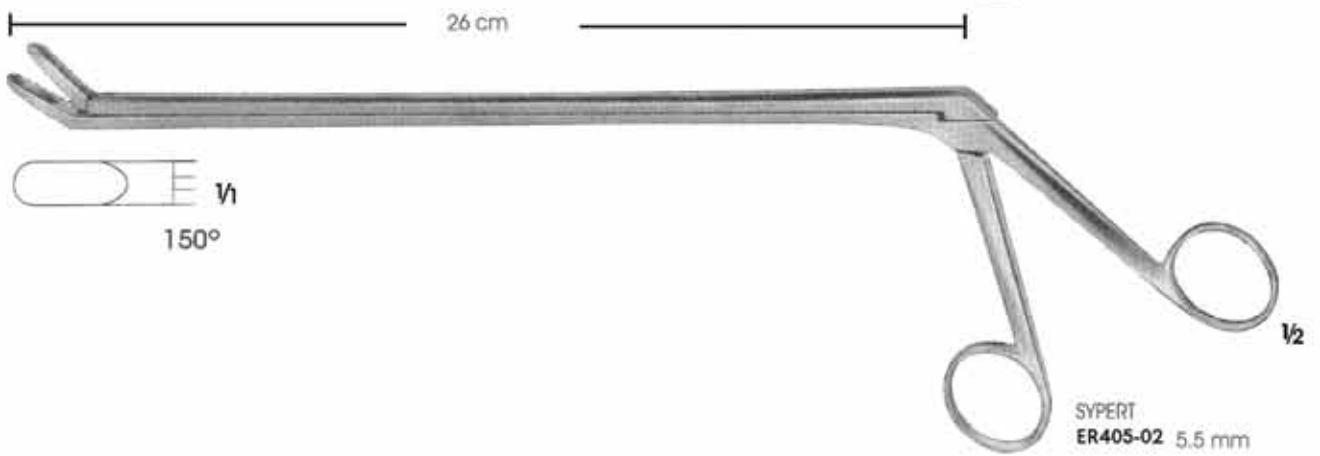
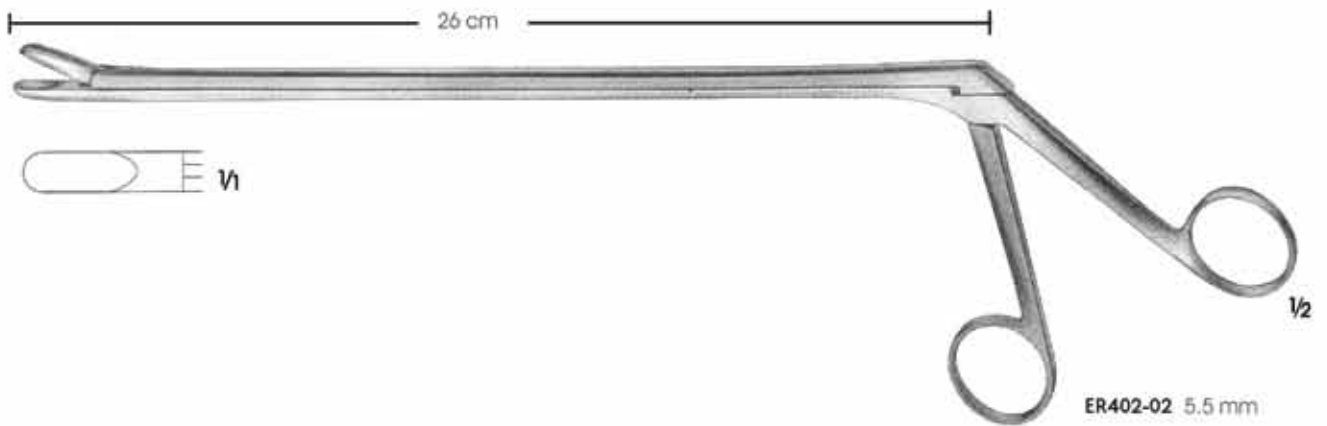

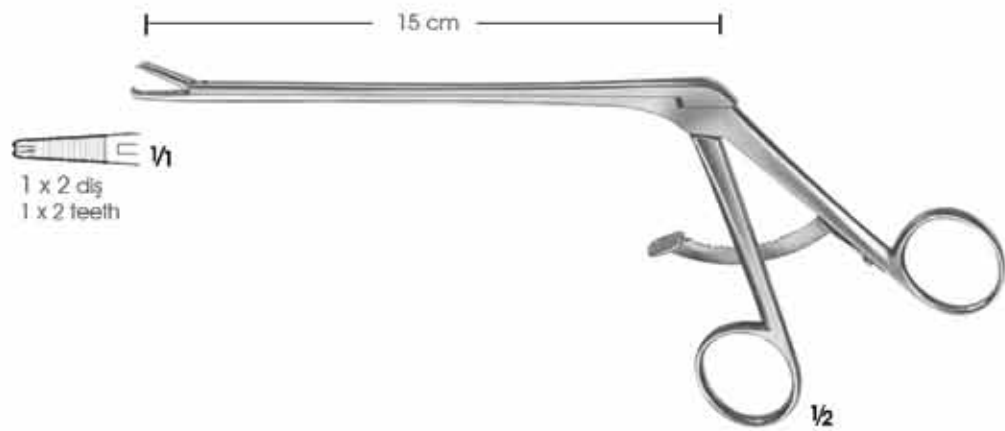

KRAMER
ER432-00 15 cm
Bağ tutucu grasping pens, kilitli
With catch grasping forceps for
ligamentum flavum

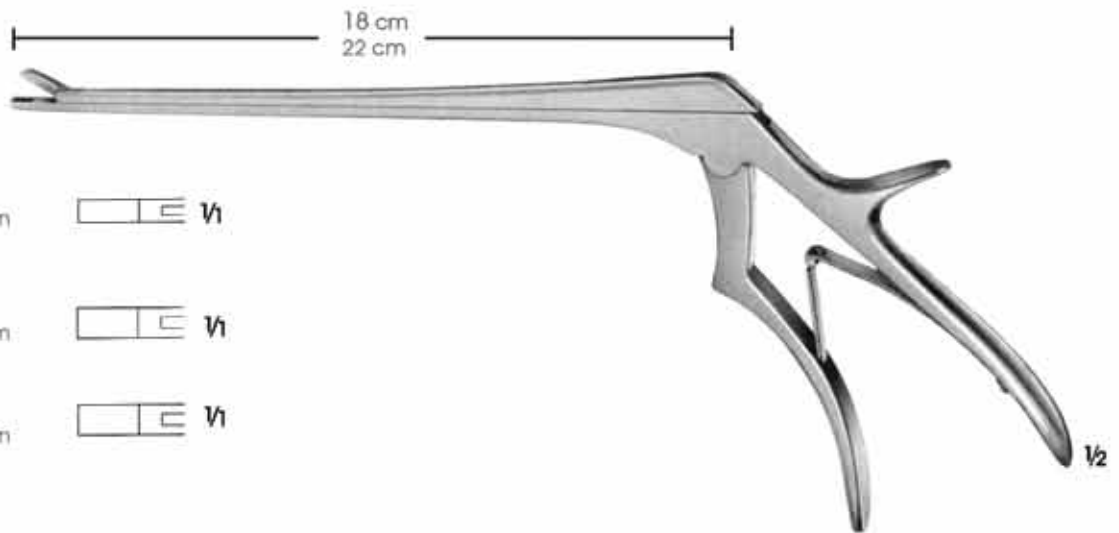

CASPAR
ER450-02 3 mm
18 cm

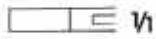

CASPAR
ER450-01 4 mm
18 cm

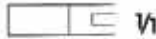

CASPAR
ER450-05 4 mm
22 cm

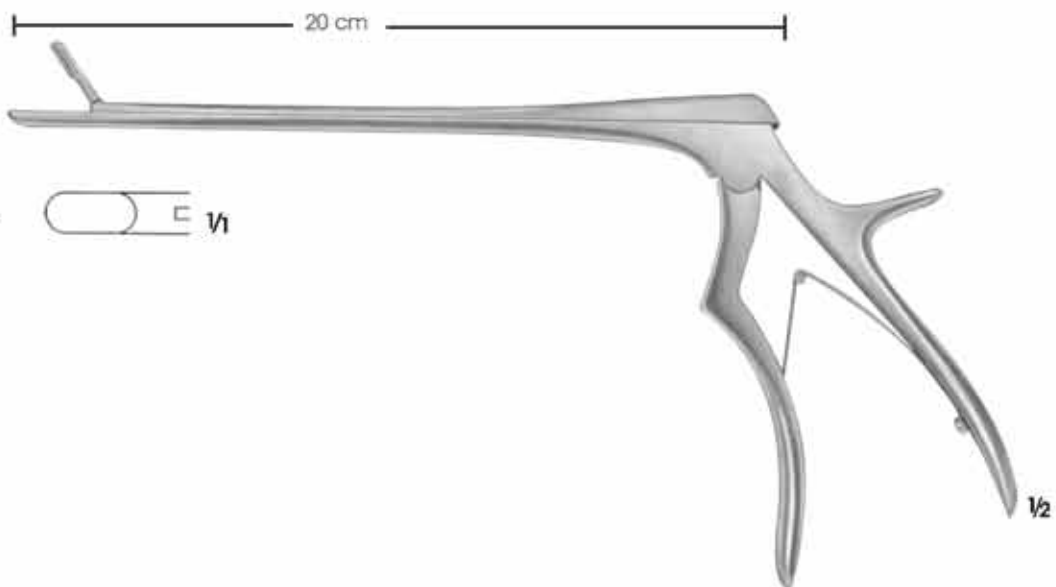
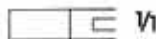

WAGNER
ER455-01 5.5 mm

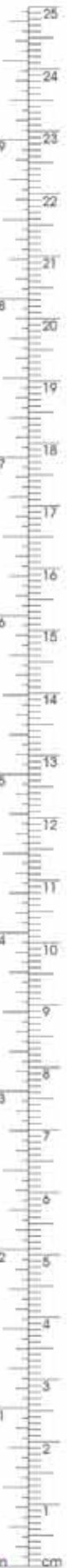

ENR

Beyin Cerrahi
Neurosurgery





CRUTCHFIELD
ES500-00
Çocuklar için/For children



CRUTCHFIELD
ES500-02
Orta boy/Medium size



GARDNER-WELLS
ES510-00
Maksimum açıklık (16 cm)
Maximum opening (16 cm)



ES500-04
Matkap ucu, büyük
Drill point, large
Ø 5 mm



1/2

ES500-03
Matkap ucu, küçük
Drill point, small
Ø 3.5 mm



ES505-10
Anahtar/wrench



ES505-01
Pimleri ayarlanabilir büyük boy
Traksiyon anahtarları ile
Large size Traction tongs with
adjustable pins and spanner
S 505.10

1/2

HUDSON
EV500-00
Komple/Complete
EV500-01-EV500-02
EV500-03-EV500-04-EV500-05
EV500-06-EV500-07



HUDSON
EV500-02
Sadece başlık
Brace only



HUDSON
EV500-01
Sadece uzatma parçası
Extension piece only

HUDSON DOWNS
EV501-00 Komple/Complete
EV501-01-EV501-02
EV500-03-EV500-04-EV500-05
EV500-06-EV500-07

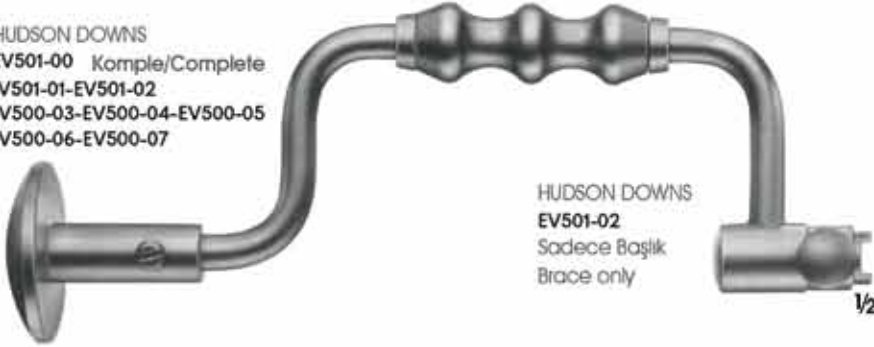

HUDSON DOWNS
EV501-02
Sadece Başlık
Brace only



HUDSON DOWNS
EV501-01
Uzatma parçası
Extension piece

HUDSON
EV502-00 Komple/Complete
EV502-01-EV502-02
EV500-03-EV500-04-EV500-05
EV500-06-EV500-07



HUDSON
EV502-02
El matkabı
Hand drill



HUDSON
EV502-01
Sadece uzatma parçası
Extension piece only



CUSHING
EV500-15
Ø 10 mm

CUSHING
EV500-17
Ø 15 mm

CUSHING
EV500-03
Ø 14 mm

MCKENZIE
EV500-15
Ø 13 mm

HUDSON
EV500-05
Ø 14 mm

HUDSON
EV500-06
Ø 16 mm

ADSON
EV500-08
Ø 15 mm

HUDSON
EV500-10
Ø 22 mm

HUDSON
EV500-11
Ø 9 mm

EV500-07
Ø 2 mm



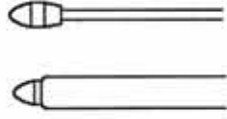

ET543-00 Ø 4 mm
43.5 cm
ET543-01 Ø 4 mm
60 cm

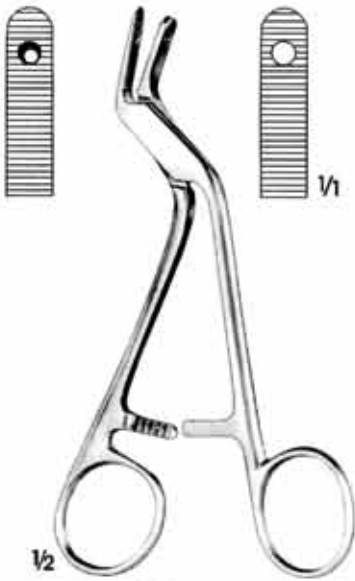

ADSON
EP570-00
15 cm



EP572-00
Koruma pensil
Protection forceps
20.5 cm



SWEET
EP560-00 20 cm
EP560-01 23 cm

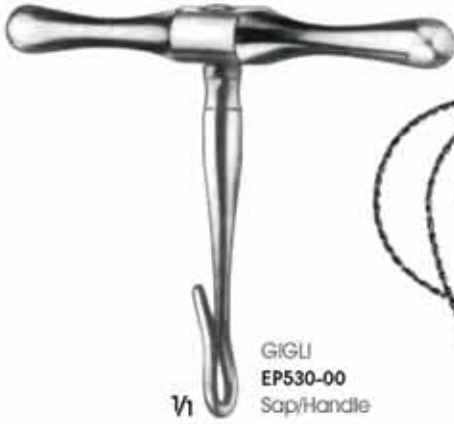

GIGLI
EP530-00
Sap/Handle



GIGLI
EP536-00 30 cm
EP536-01 40 cm
EP536-02 50 cm
iki sargılı/Two windings

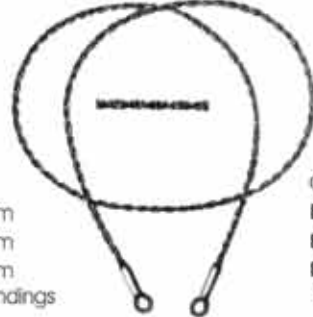

GIGLI
EP537-00 30 cm
EP537-01 40 cm
EP537-02 50 cm
Üç sargılı/Three winding



DE MARTEL
EP540-00 35 cm
Kondüktör için gigli testere telli, esnek
Gigli saw for the flexible conductor wire



DAHLGREN
EP562-01



DE VILBISS
EP564-00
1 huk dahil/with 1 hook
20 cm



DAHLGREN
EP562-00
2 huk ile birlikte
With 2 extra hooks
21 cm

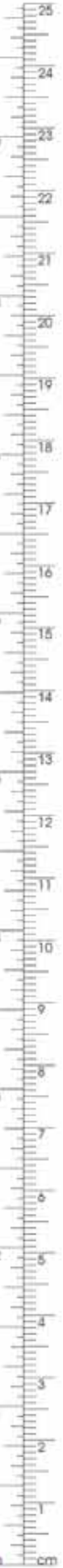



AACHEN
EK560-01 7 + 8 mm
EK560-02 10 + 11 mm
EK560-03 13 + 14 mm
EK560-04 16 + 17 mm
EK560-05 19 + 20 mm
EK560-06 22 + 25 mm
 Bükülebilir/Malleable
 20 cm

1/2



10 cm

HEIFETZ
EK570-01 8 mm
EK570-02 11 mm
EK570-03 14 mm
EK570-04 17 mm
 Bükülebilir/Malleable
 15.5 cm

1/2



10 cm

HEIFETZ
EK571-05 8 mm
EK571-00 11 mm
EK571-01 14 mm
EK571-02 17 mm
EK571-03 20 mm
 Bükülebilir/Malleable
 20 cm

1/2

Ø 5 mm



SCOVILLE
EK567-01 10 + 13 mm
EK567-03 16 + 19 mm
 Bükülebilir/Malleable
 20 cm



CUSHING
EK563-01 13 + 19 mm
EK563-02 16 + 21 mm
 17 cm
EK563-05 19 + 25 mm
EK563-06 21 + 26 mm
 20 cm



1/2

1/2

EK564-01 7 + 9 mm
EK564-02 11 + 13 mm
EK564-03 15 + 18 mm
EK564-04 18 + 22 mm
 Bükülebilir/Malleable
 18 cm



OLIVECRONA
EK566-01 7 + 9 mm
EK566-02 11 + 13 mm
EK566-03 15 + 18 mm
EK566-04 18 + 22 mm
 Esneyebilir/Flexible
 18 cm



OLIVECRONA
EK565-01 7 + 9 mm
EK565-02 11 + 13 mm
EK565-03 15 + 18 mm
EK565-04 18 + 22 mm
 Esneyebilir/Flexible
 18 cm



EK561-01 9 mm
EK561-02 12 mm
 20 cm
EK561-03 12 mm
 25 cm
 Bükülebilir/Malleable



EK562-01 12 mm
EK562-02 17 mm
 20 cm
EK752-02 25 mm
 25 cm
 Bükülebilir/Malleable



APFELBAUM
EK573-01 5 - 12 mm
EK573-02 8 - 19 mm
EK573-03 10 - 19 mm
EK573-04 13 - 22 mm
EK573-05 16 - 22 mm
EK573-06 20 - 22 mm
 45 mm, 15 cm

EK573-07 5 - 12 mm
EK573-08 8 - 19 mm
EK573-09 10 - 19 mm
EK573-10 13 - 22 mm
EK573-11 16 - 22 mm
EK573-12 20 - 22 mm
 65 mm, 17 cm

EK573-13 5 - 12 mm
EK573-14 8 - 19 mm
EK573-15 10 - 19 mm
EK573-16 13 - 22 mm
EK573-17 16 - 22 mm
EK573-18 20 - 22 mm
 75 mm, 18 cm
 Esneyebilir, konik
 Flexible, conical



KOÇUK/SMALL



1/2



1/1

EG070-00 25°
15 cm



1/2



EG070-01
25°



EG071-01
65°

EG070-01-EG071-01
20 cm



1/2



EG070-03
25°



EG071-03
65°

EG070-03-EG071-03
28 cm

ORTA/MEDIUM

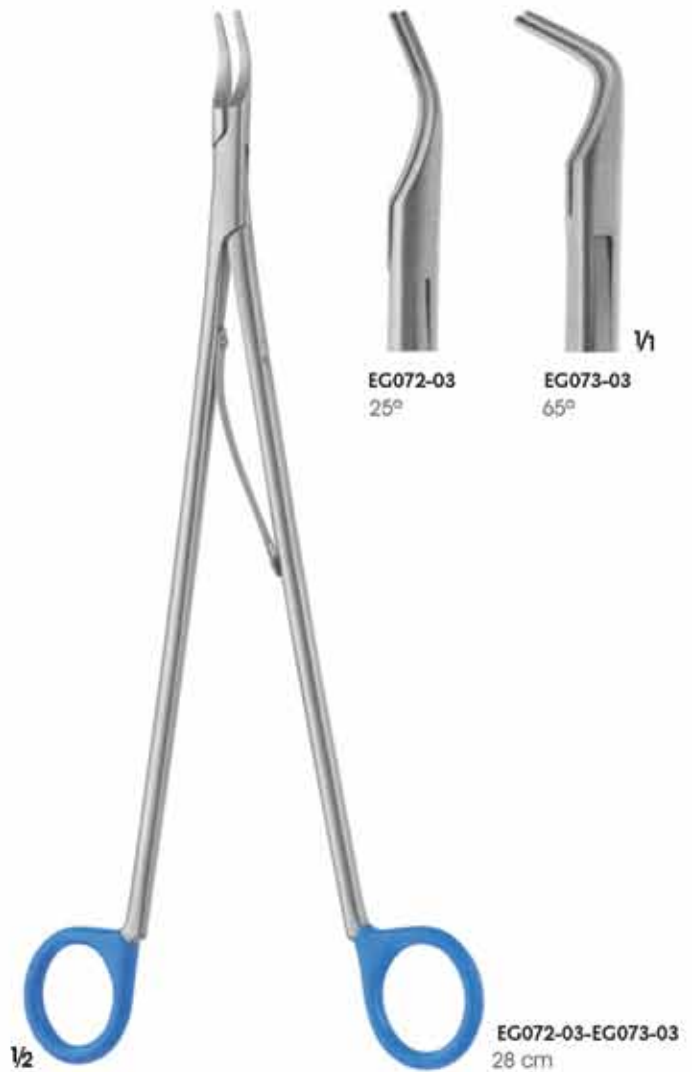
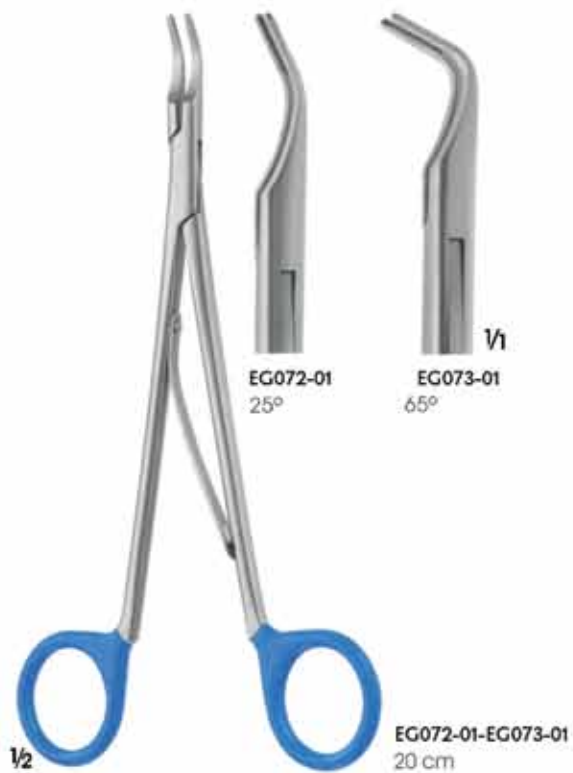
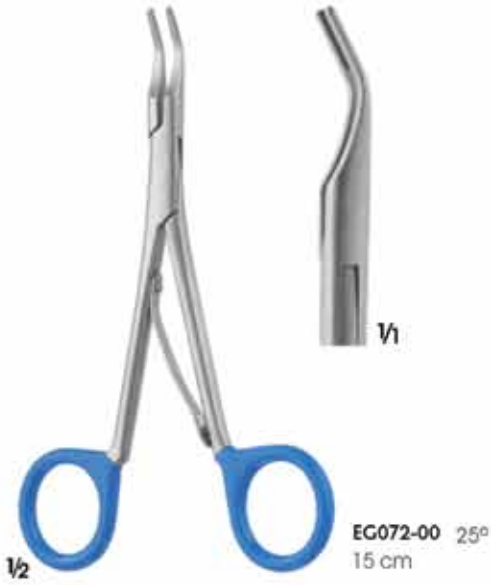

ORTA BÜYÜK/MEDIUM LARGE



EG074-01
25°



EG075-01
65°



EG076-01
90°

EG074-01-EG076-01
20 cm



EG074-03
25°



EG075-03
65°



EG076-03
90°

EG074-03-EG076-03
28 cm

BÜYÜK/LARGE



1/2



EG077-01
25°



EG0778-01
65°



EG079-01
90°

1/1

EG077-01-EG079-01
20 cm



1/2



EG077-03
25°



EG078-03
65°



EG079-03
90°

1/1

EG074-03-EG076-03
28 cm





RANEY
ET550-00
16 cm



MC KENZIE
ET555-00
15 cm

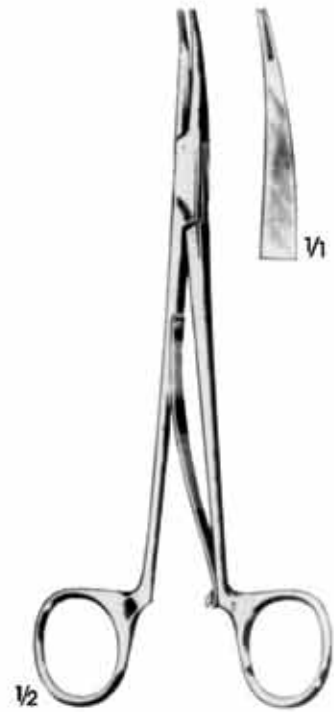

MC KENZIE
ET555-01
19 cm

MINI

STANDART

ET330-01T

ET332-01T



ET330-03T

ET332-03T



ET330-05T

ET332-05T

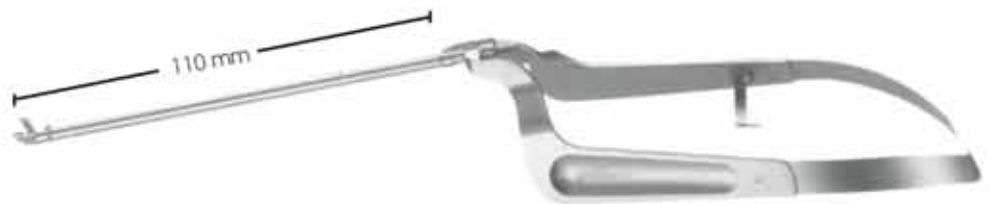



YASARGIL
ET595-00 Mini/Mini
ET595-01 Standart/Standard
17,5 cm



YASARGIL
ET596-00 Mini/Mini
ET596-01 Standart/Standard
17,5 cm

Mini/Mini Standart/Standard

ET596-02 ET596-03
Düz/Straight

ET597-02 ET597-03
15° Açılı/15° Angled

ET598-02 ET598-03
30° Açılı/30° Angled



YASARGIL
ET596-02-ET596-03
ET597-02-ET597-03
ET598-02-ET598-03
21,5 cm

ET596-04 ET596-05
Düz/Straight

ET597-04 ET597-05
15° Açılı/15° Angled

ET598-04 ET598-05
30° Açılı/30° Angled



YASARGIL
ET596-04-ET596-05
ET597-04-ET597-05
ET598-04-ET598-05
23,5 cm



ET599-00 Mini/Mini
ET599-01 Standart/Standard
21,5 cm

MINI STANDART

ET340-01T

ET340-01T

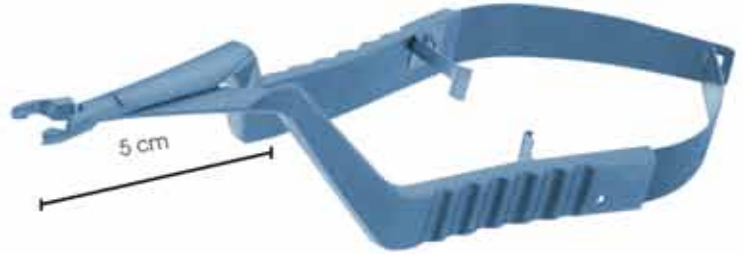

YASARGIL
ET340-01T-ET350-01T
18 cm.

ET340-03T

ET350-03T



Düz/Straight

ET341-03T

ET351-03T



15° Açılı/15° Angled

ET343-06T

ET353-06T



30° Açılı/30° Angled



YASARGIL
ET340-03T-ET350-03T
ET341-03T-ET351-03T
ET343-03T-ET353-03T
22 cm

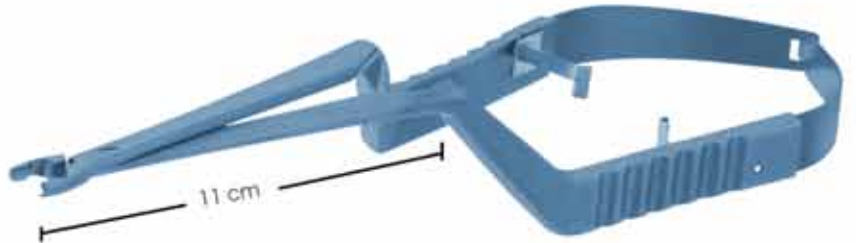

YASARGIL
ET340-06T-ET350-06T
ET341-06T-ET351-06T
ET343-06T-ET353-06T
25 cm

ET340-06T

ET350-06T



Düz/Straight

ET341-06T

ET351-06T



15° Açılı/15° Angled

ET343-06T

ET353-06T



30° Açılı/30° Angled

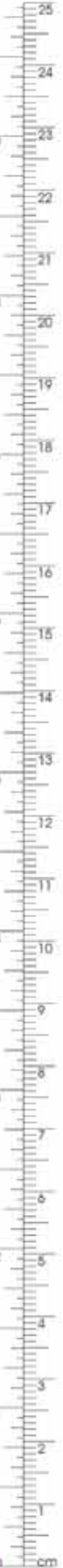



EA306-00
Ayna sapı
Mirror handle
10.5 cm



EA302-01
Laringel ayna
Laryngeal mirror
12 cm



EA300-01
Altıgen saplı Laringel
ayna
Laryngeal mirror with
Hexagonal handle
18 cm



YASARGIL
EA325-01 Ø 6 mm
Hareketli mikro ayna
Movable micro mirror
24 cm



EA320-01
Ayna/Mirror
26 cm

Galea tespitinde kullanılan Buldog klempı yaylı kanca, örtü bezine bağlanabilir.
Spring hook for galea fixation with Buldog clamp, to be fastened to covering drape.

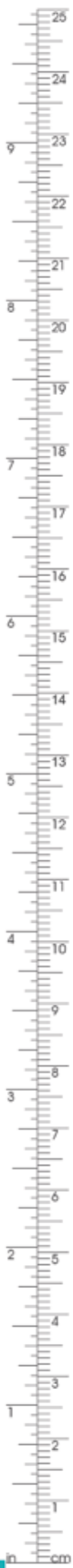
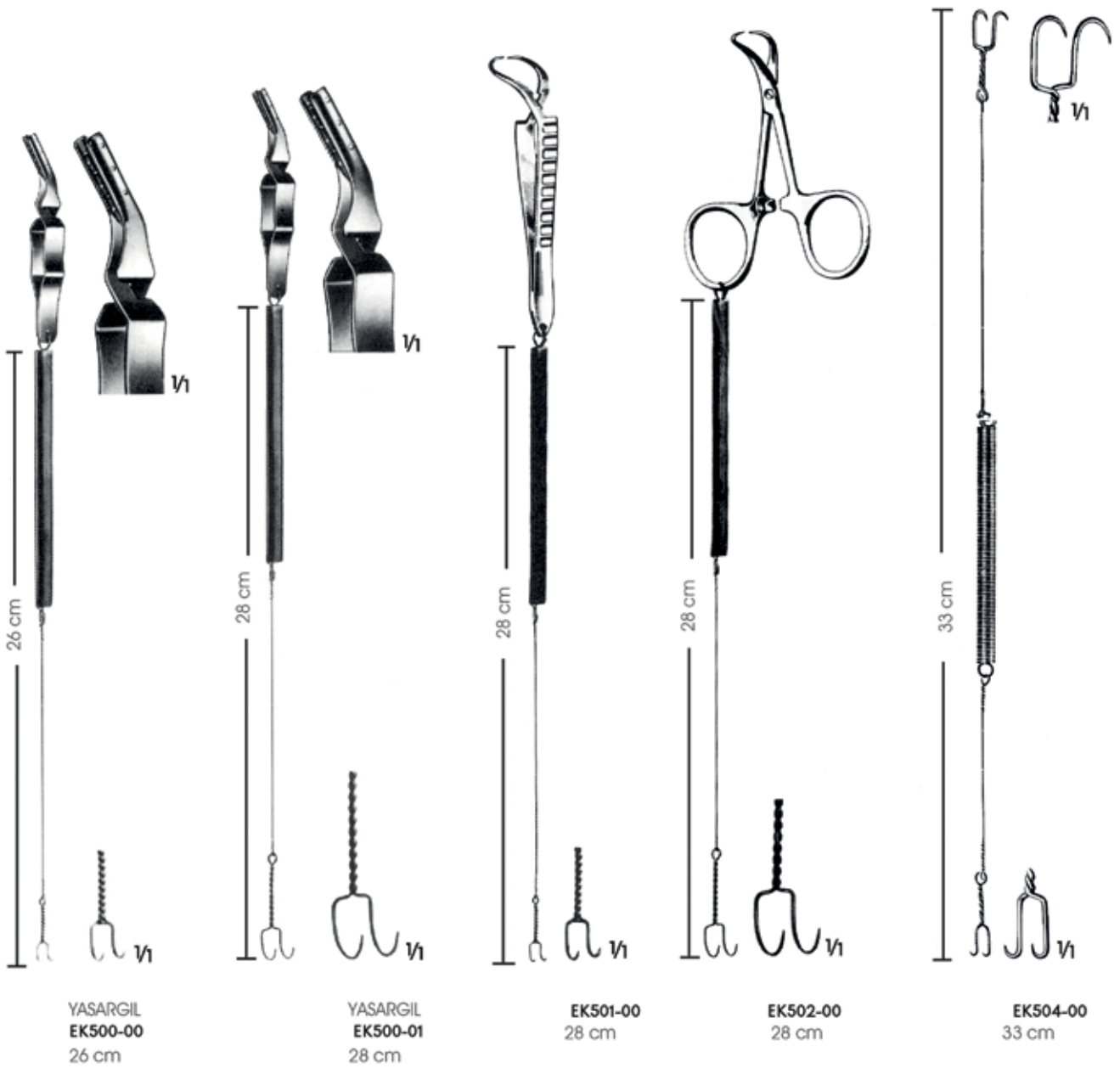





JACOBSON
EJ076-00
Sonda, küresel uçlu, açılı
Probe, with ball tip, angled
18.5 cm



JACOBSON
EJ076-01
Sonda, küresel uçlu
Probe, with ball tip
18.5 cm



ASSMUS
ET086-00 \varnothing 3 mm
Sonda, küresel uçlu
Probe with ball tip
39.5 cm



CASPAR
ET086-02
Ligatür ayarlayıcısı
Ligature adjuster
23 cm



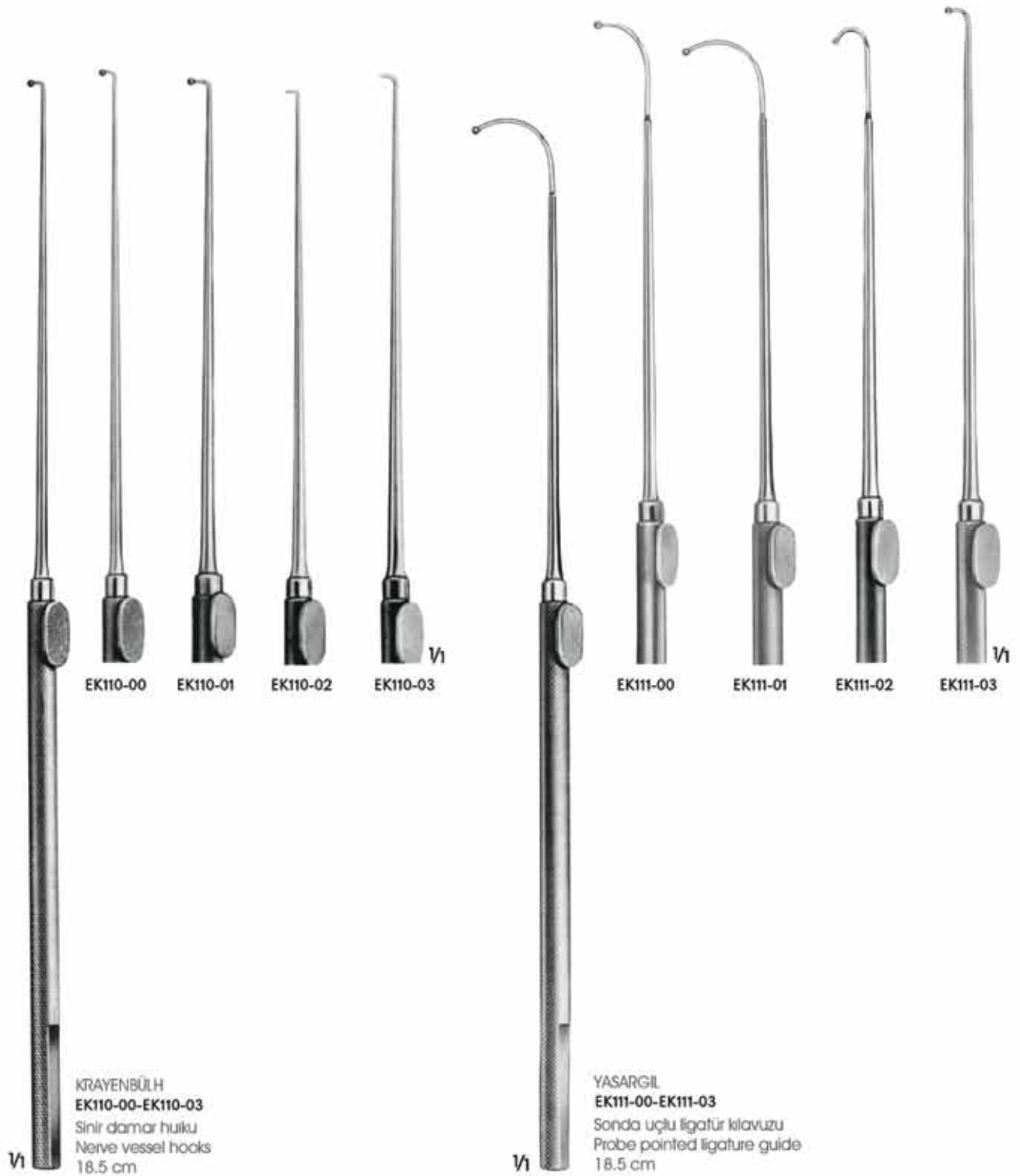

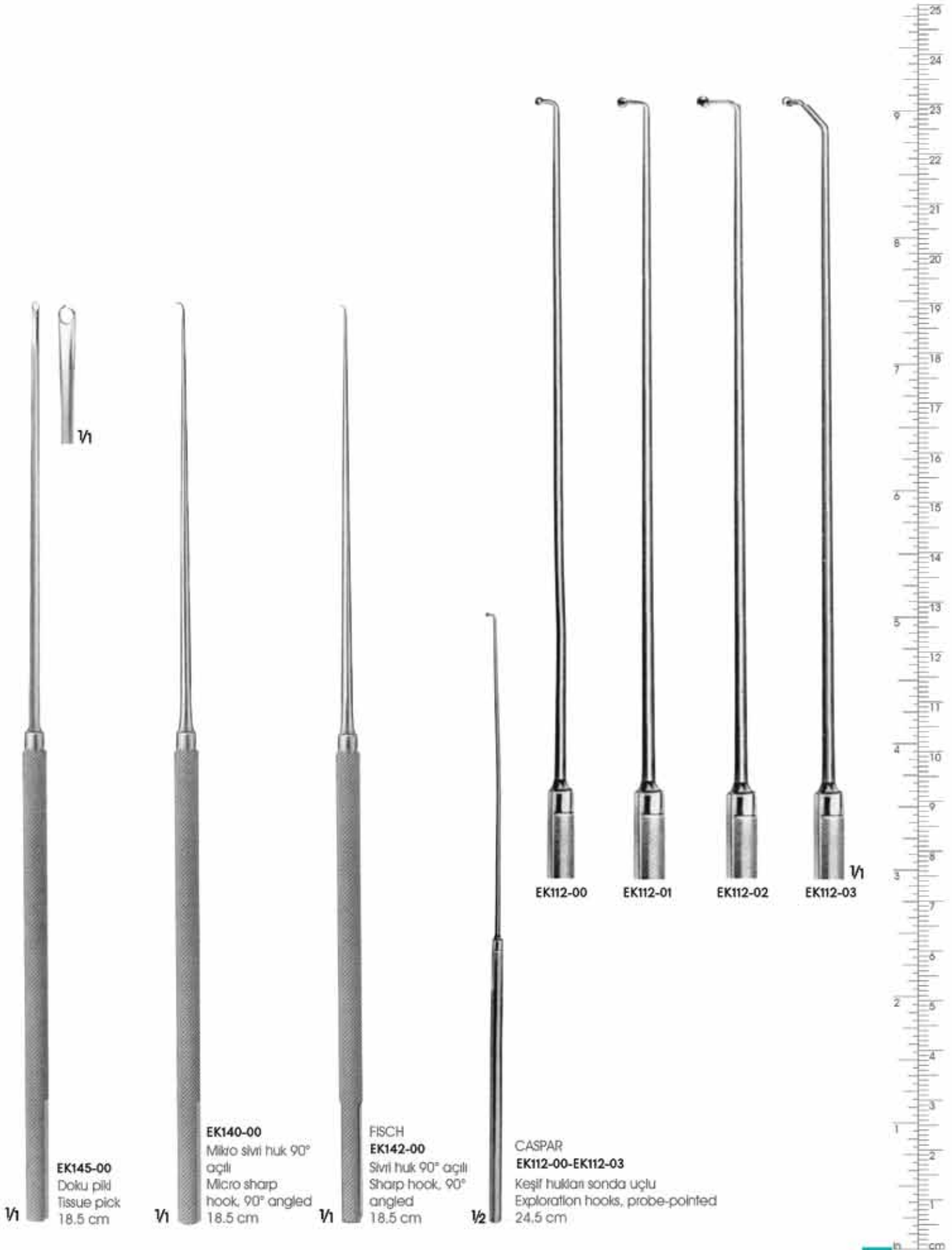



V1

OPPEL
EB069-01
Mikro bıçak
Micro Knife
Düz, Bükülebilir
Straight, Malleable
23 cm



V1

OPPEL
EM136-04
Mikro disektör
Micro dissector
Eğri, Bükülebilir
Curved, Malleable
23 cm



V1



V1

OPPEL
EK117-01 90°
Mikro ekartör
Micro Retractor
Künt, Bükülebilir, Ø 2 mm
Blunt, Malleable
23 cm



V1

OPPEL
EK117-04 45°
Mikro ekartör
Micro retractor
Künt, Bükülebilir, Ø 2 mm
Blunt, Malleable
23 cm







EM127-00
Raspa, plaka
şeklinde
Raspatory,
plate-shaped
23 cm



EM125-01
Disektör, künf
Dissector, blunt
23 cm



EM133-00
Disektör, yukarı eğimli
Dissector, upwards
curved
23 cm



EM134-00
Disektör künf,
aşağı eğimli
Dissector,
downwards
curved, blunt
23 cm



EM128-00
Raspa, plaka
şeklinde
Raspatory,
plate-shaped
23 cm



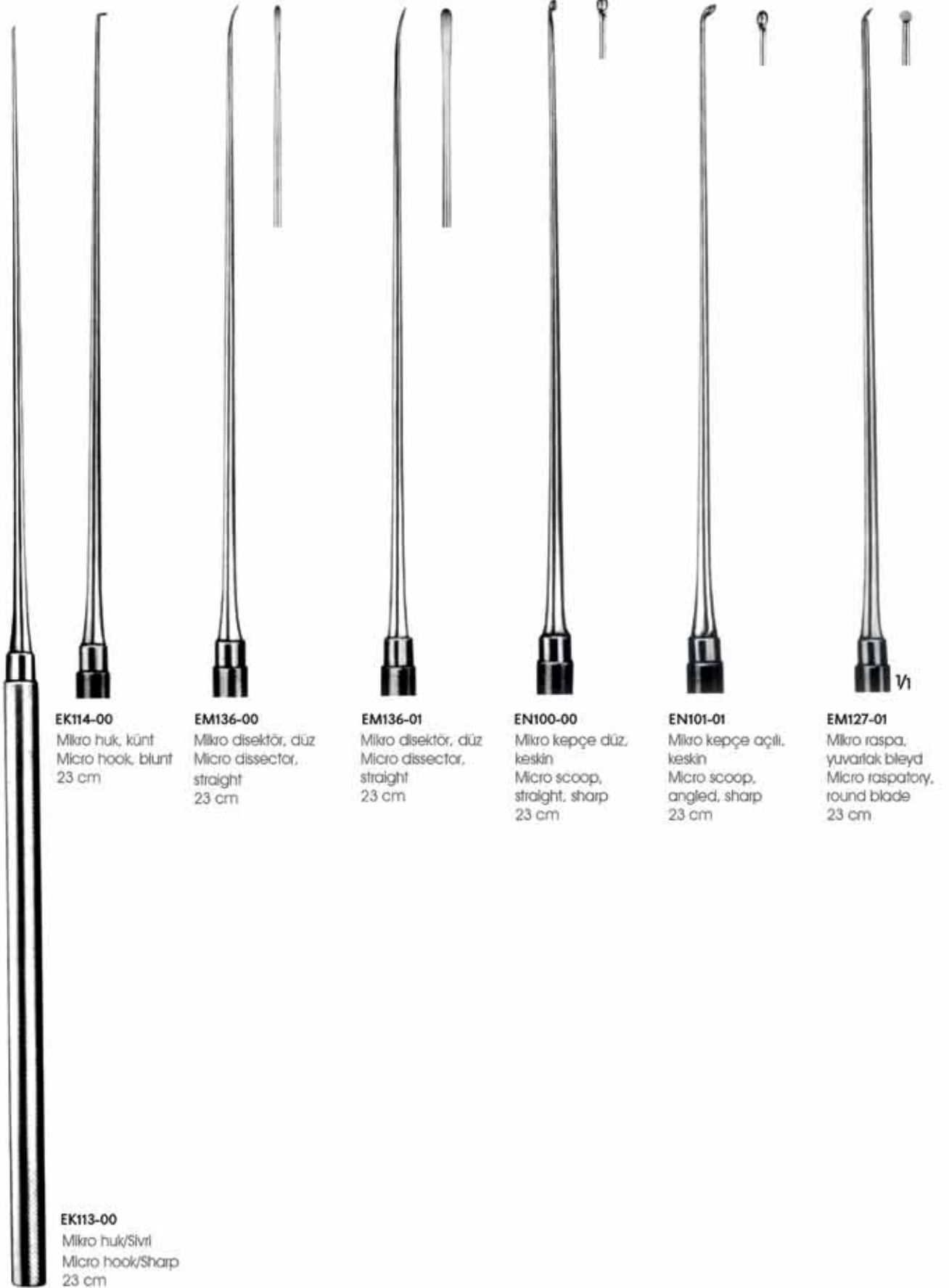

EK114-00
Mikro huk, k nt
Micro hook, blunt
23 cm

EM136-00
Mikro disekt r, d z
Micro dissector,
straight
23 cm

EM136-01
Mikro disekt r, d z
Micro dissector,
straight
23 cm

EN100-00
Mikro ke çe d z,
keskin
Micro scoop,
straight, sharp
23 cm

EN101-01
Mikro ke çe a ılı,
keskin
Micro scoop,
angled, sharp
23 cm

EM127-01
Mikro raspa,
yuvarlak bıyda
Micro raspatory,
round blade
23 cm

EK113-00
Mikro huk/Sivri
Micro hook/Sharp
23 cm



**YASARGIL
EM137-00**
Mikro raspa, açılı
Micro raspatory,
angled
18.5 cm



**YASARGIL
EM137-01**
Mikro disektör, açılı
Micro dissector,
angled
18.5 cm



**YASARGIL
EM137-02**
Mikro disektör, açılı
Micro dissector,
angled
18.5 cm



**YASARGIL
EM137-03**
Mikro raspa, hafif
kavisli
Micro raspatory,
slightly curved
18.5 cm



**YASARGIL
EM137-04**
Mikro raspa, eğri
Micro raspatory,
curved
18.5 cm



**YASARGIL
EM138-00**
Mikro raspa, aşağı eğimli
Micro raspatory, down-
wards curved
18.5 cm



**YASARGIL
EM138-01**
Mikro raspa, aşağı eğimli
Micro raspatory, downwards
curved
18.5 cm



**YASARGIL
EM138-02**
Mikro raspa, yukarı eğimli
Micro raspatory, upwards
curved
18.5 cm

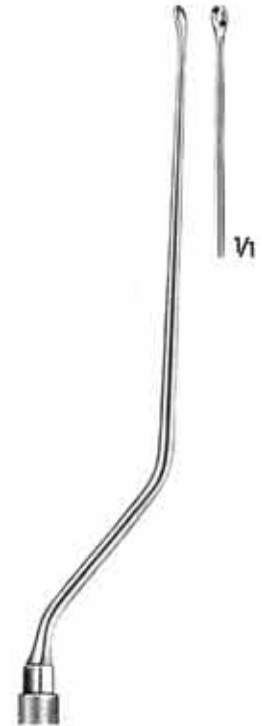

**YASARGIL
EN102-00**
Mikro kaşık küret
Micro scoop
18.5 cm





JACOBSON
EB064-00
Damar bıçağı
Vessel knife
18.5 cm

EB060-00-EB062-03
18.5 cm



KOOS
EB060-00
Yukarı eğimil
Curved upwards



KOOS
EB060-01
Aşağı eğimil
Curved downwards



KOOS
EB060-02
Yukarı eğimil
Curved upwards



KOOS
EB060-03
Aşağı eğimil
Curved downwards



KOOS
EB062-00
Aşağı eğimil
Curved downwards



KOOS
EB062-01
Yukarı eğimil
Curved upwards



YAŞARGİL
EB062-02
Aşağı eğimil
Curved downwards



YAŞARGİL
EB062-03
Yukarı eğimil
Curved upwards

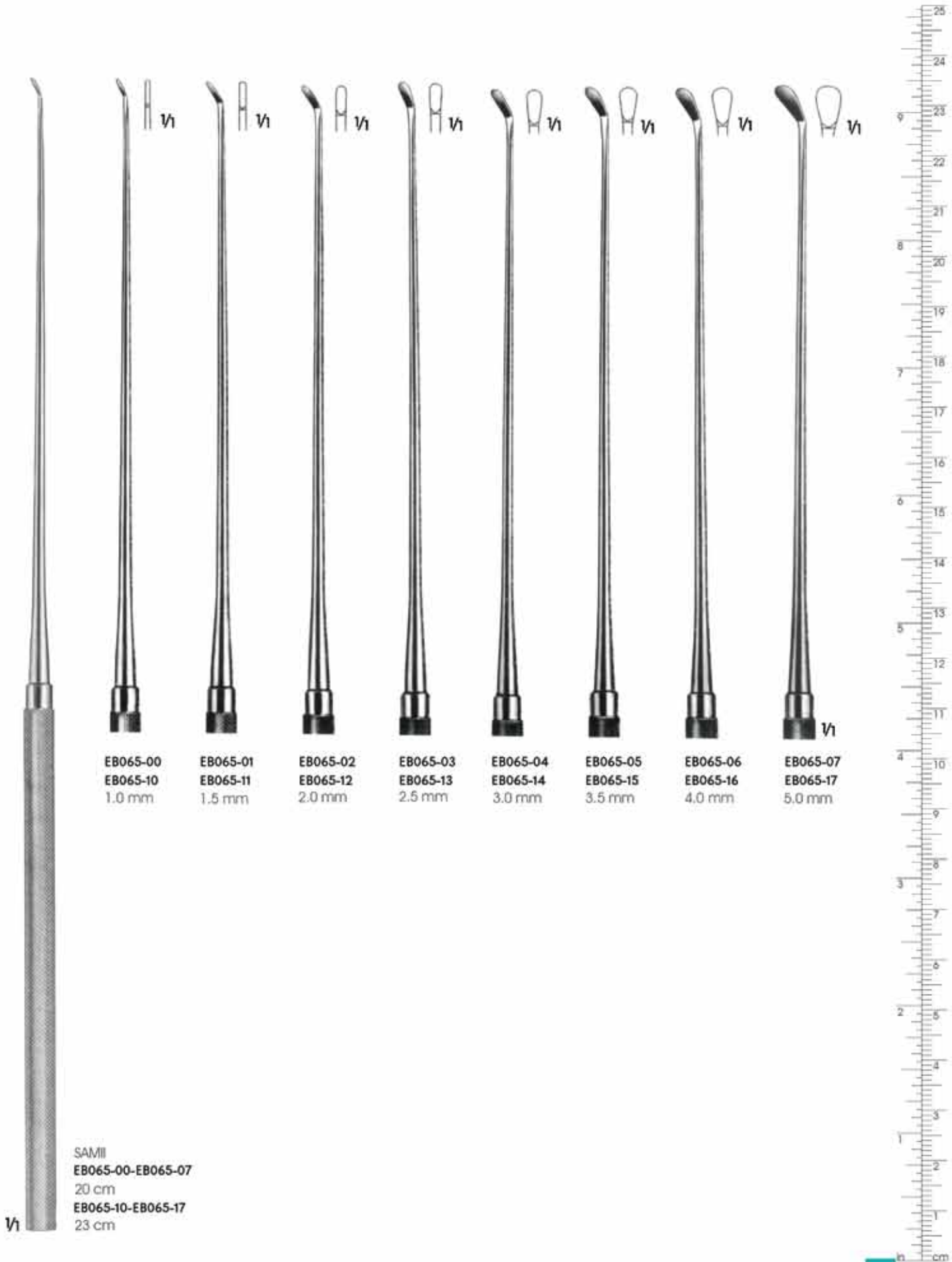

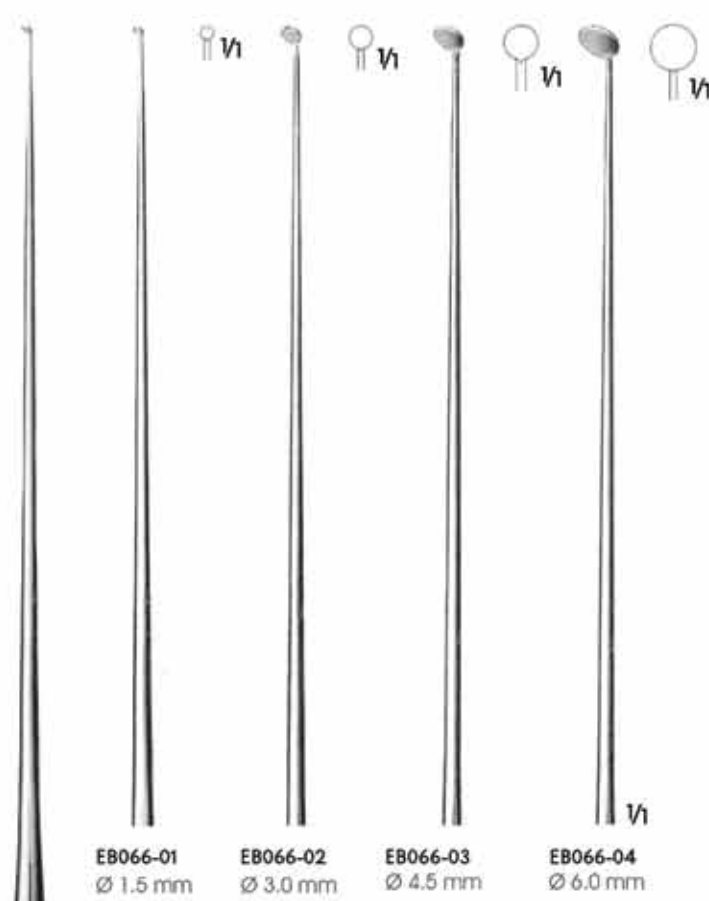

EB066-01
Ø 1.5 mm

EB066-02
Ø 3.0 mm

EB066-03
Ø 4.5 mm

EB066-04
Ø 6.0 mm

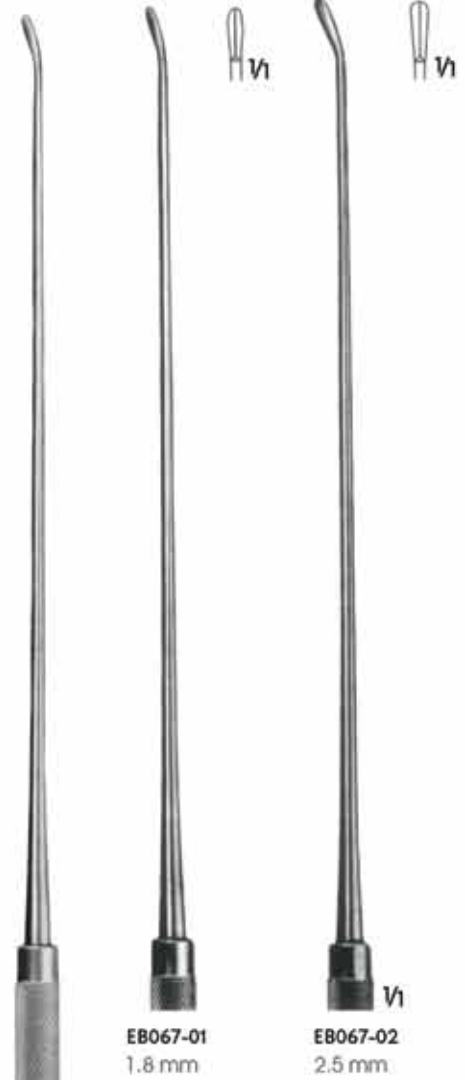

EB067-01
1.8 mm

EB067-02
2.5 mm

VI

SAMII
EB066-01-EB066-04
Tümör dokusu için bıçaklar
Knives for tumor tissue
23 cm

VI

SAMII
EB067-01-EB067-02
Tümör dokusu için bisturi
bıçakları
Lancet knives for tumor tissue
23 cm



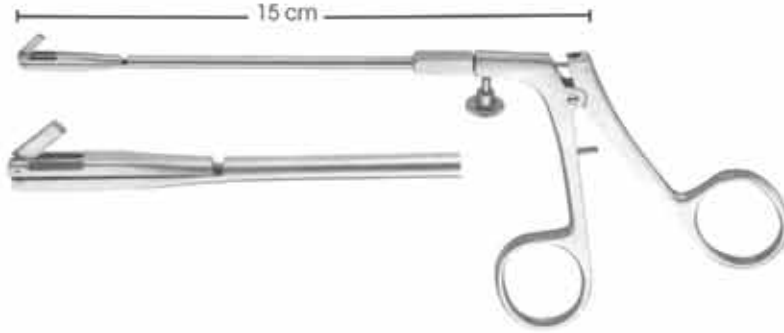

EP470-00
Antrum panç
Antrum punch



EV644-00
Anahtar/Key
15 cm

PAPAVERO-CASPAR
EL298-01 80 x 11 mm
EL298-02 90 x 13 mm
EL298-03 100 x 15 mm



EV644-00 ile beraber
With key **EV644-00**
İnce profil, hafif transfenoidal spekulum
Slim profile and lightweight specula for
transsphenoidal

HARD COATED



EL298-02B 90 x 13 mm
Transsfenoidal spekulum
Transsphenoidal specula



PAPAVERO-HARTMANN
EL265-00
EL298-01, EL298-02, EL298-03 ile birlikte
Use with **EL298-01, EL298-02, EL298-03**

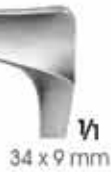

COTTLE
EL275-02-EL275-03
Burun spekulumu/Nasal speculum
EL298-01, EL298-02, EL298-03 ile birlikte
Use with **EL298-01, EL298-02, EL298-03**
13.5 cm

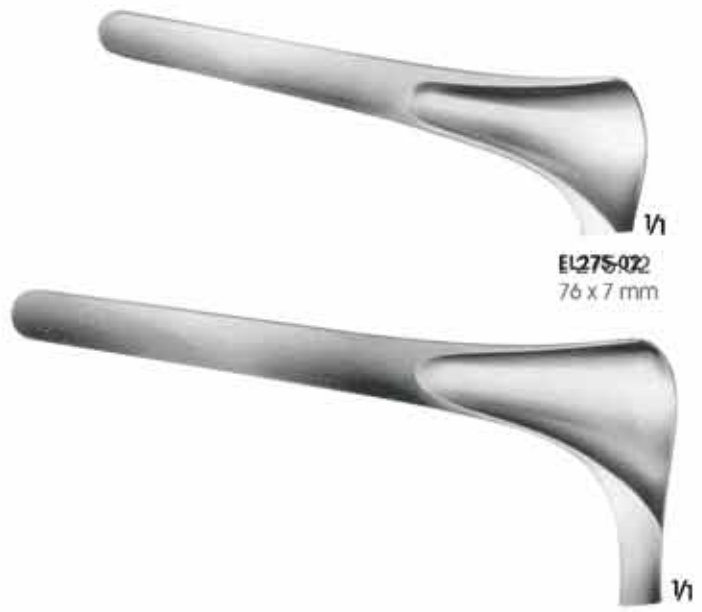



CUSHING-LANDOLT

EL295-00 70 x 15 mm
EL295-01 90 x 15 mm
EL295-02 110 x 15 mm

Transfenoidal, hipofizektomi spekulum
Specula for transsphenoidal hypophysectomy



JANSEN-MIDDLETON

EP580-00
20 cm



COTTLE

EM631-01 4 mm
EM631-02 7 mm
EM631-03 9 mm
EM631-04 12 mm

Derinlik işaretli çizil
Chisel with depth markings
18 cm



PAPAVERO

EM613-00 4 mm
Bayonet çizil
Bayonet chisel, 4 mm
22 cm



LANDOLT
EL296-00

Spekulum için ayırıcı
Spreader for specula
L 295.00-L 295.02
21 cm



COTTLE

EM815-01 240 gr
Çekiç, bir tarafı düz
bir tarafı dış bükümlü
Mallet, 1 side flat, 1
side convex
18,5 cm





HARDY
EN650-00P
Küret/Curette
90° açılı, kısa boyun
90° angled, short
neck
Ø 4 mm
26.5 cm



HARDY
EN650-01P
Küret/Curette
90° açılı, kısa boyun
90° angled, short
neck
Ø 6 mm
26.5 cm



HARDY
EN651-00P
Küret/Curette
90° uzun boyun
90° long neck
Ø 4 mm
26.5 cm



HARDY
EN651-01P
Küret/Curette
90° açılı, uzun boyun
90° angled, long
neck
Ø 6 mm
26.5 cm



HARDY
EN652-00P
Küret/Curette
45° açılı, kısa boyun
45° angled, short neck
Ø 4 mm
26.5 cm

V1

V1



HARDY
EM135-00P
Enüktatör/Enucleator
sol/left
26.5 cm



HARDY
EM135-01P
Enüktatör/Enucleator
sağ/right
26.5 cm



REULEN-LANDOLT
EK157-00P
Huk/Hook
Ø 1.7 mm
26.5 cm



REULEN-LANDOLT
EK139-00P
Dissector/Dissector
Kunt/Blunt
Ø 2 mm
26.5 cm



NICOLA
EN654-01P
Küret/Curette
45° yatay açılı
kısa boyun
45° horizontal angled
short neck
Ø 6.5 mm
26.5 cm



NICOLA
EN655-01P
Küret/Curette
45° dikey açılı
uzun boyun
45° vertical angled
long neck
Ø 6.5 mm
26.5 cm





HARDY
EN660-00P
Küret/Curette
90° sol açılı
kısa boyun
90° left angled
short neck
Ø 4 mm
28 cm



HARDY
EN660-01P
Küret/Curette
90° sol açılı
kısa boyun
90° left angled
short neck
Ø 6 mm
28 cm



HARDY
EN661-00P
Küret/Curette
90° sağ açılı
kısa boyun
90° right angled
short neck
Ø 4 mm
28 cm



HARDY
EN661-01P
Küret/Curette
90° sağ açılı
kısa boyun
90° right angled
short neck
Ø 6 mm
28 cm



HARDY
EN664-00P
Küret/Curette
45° yatay sol açılı
kısa boyun
45° horizontal left
angled, short neck
Ø 4 mm
28 cm



HARDY
EN665-00P
Küret/Curette
45° yatay sağ açılı
kısa boyun
45° horizontal right
angled, short neck
Ø 4 mm
28 cm



HARDY
EN662-00P
Küret/Curette
90° sol açılı
uzun boyun
90° left angled
long neck
Ø 4 mm
28 cm



HARDY
EN662-01P
Küret/Curette
90° sol açılı
uzun boyun
90° left angled
long neck
Ø 6 mm
28 cm



**HARDY
EN663-00P**
Küret/Curette
90° sağ açılı
uzun boyun
90° right angled
long neck
Ø 4 mm
28 cm



**HARDY
EN663-01P**
Küret/Curette
90° sağ açılı
uzun boyun
90° right angled
long neck
Ø 6 mm
28 cm



**NICOLA
EN670-00P**
Küret/Curette
45° yatay açılı
kısa boyun
45° horizontal angled
short neck
Ø 6.5 mm
28 cm



**NICOLA
EN670-01P**
Küret/Curette
45° dikey açılı
uzun boyun
45° vertical angled
long neck
Ø 6.5 mm
28 cm



**HARDY
EM145-10P**
Enükleatör/Enucleator
Sol/Left
28 cm



**HARDY
EM145-11P**
Enükleatör/Enucleator
Sağ/Right
28 cm



**REULEN-LANDOLT
EK159-00P**
Hük/Hook
Ø 1.7 mm
28 cm



**REULEN-LANDOLT
EM139-10P**
Dissector/Dissector
Künt/Blunt
Ø 2 mm
28 cm



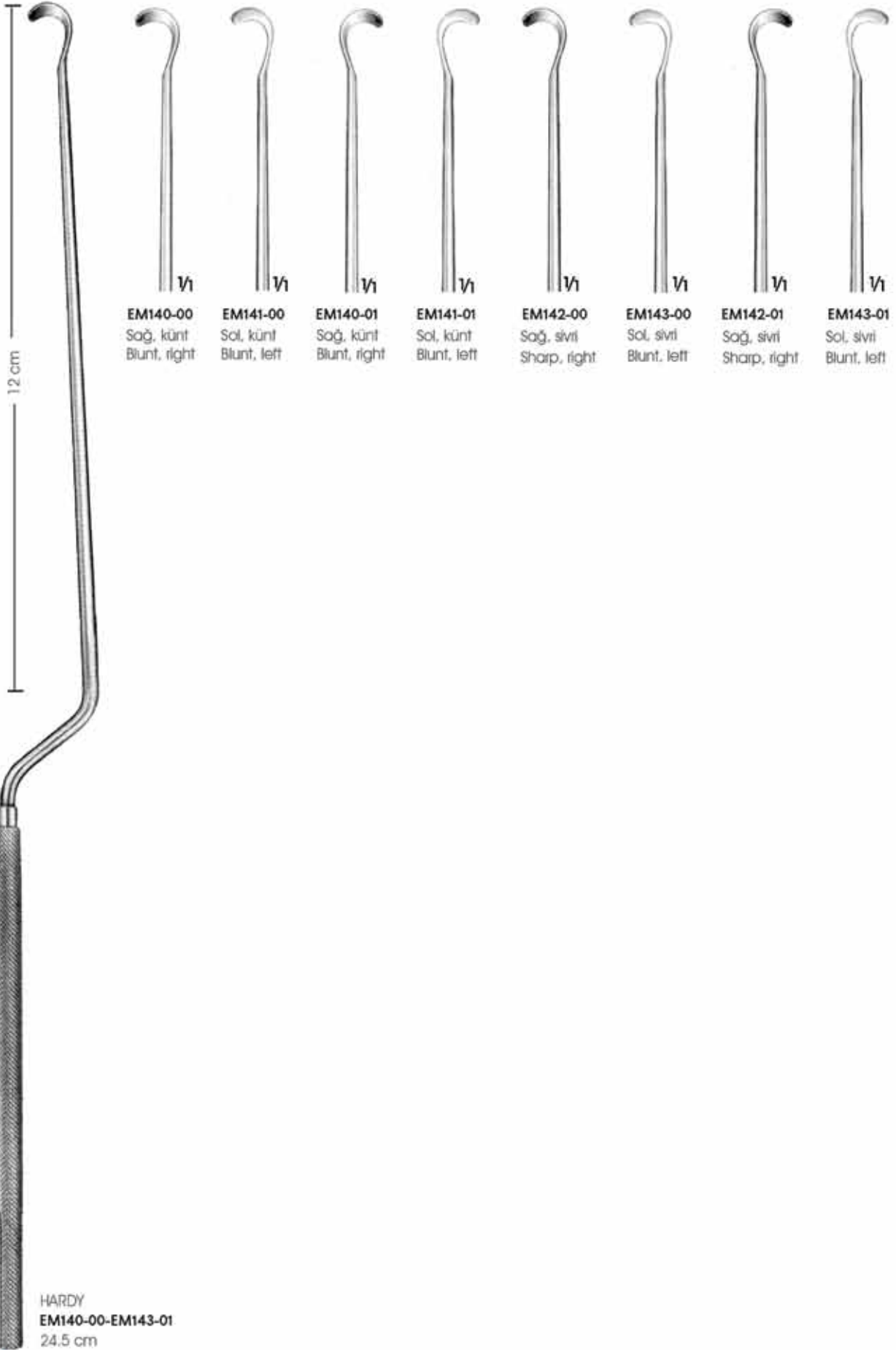



LANDOLT
EM145-01 Sağ, künt
Blunt, right
26 cm
EM146-01 Sol, künt
Blunt, left
Bükülebilir/Malleable
26 cm



LANDOLT
EN105-00
Küret, bükülebilir
Curette, malleable
26 cm



LANDOLT
EN106-00
Kaşık, bükülebilir
Spoon, malleable
26 cm



LANDOLT
EK116-00
Künt huk/Blunt hook
Bükülebilir/Malleable
26 cm



LANDOLT
EM145-00 Sağ, künt/Blunt, right
EM146-00 Sol, künt/Blunt, left
Bükülebilir/Malleable
26 cm





LANDOLT-REULEN
EM149-00 Ø 2.2 mm
Raspa, esnemez
Raspatories, rigid
26 cm

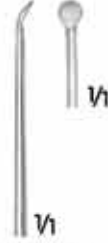

LANDOLT-REULEN
EM149-01 Ø 3.2 mm
Raspa, esnemez
Raspatories, rigid
26 cm

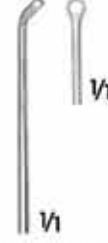

LANDOLT-REULEN
EN109-00 Ø 2.5 mm
Küret, esnemez
Curette, rigid
26 cm



LANDOLT-REULEN
EN115-00 1.7 mm
Künet huk/Blunt hook
26 cm



FAHLBUSCH
EN107-00 Ø 2.0 mm
Kaşık, bükülebilir
Spoon, malleable
26 cm



FAHLBUSCH
EN108-00 Ø 2.5 mm
Küret, bükülebilir
Curette, malleable
26 cm

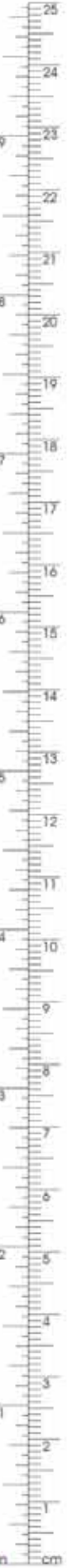

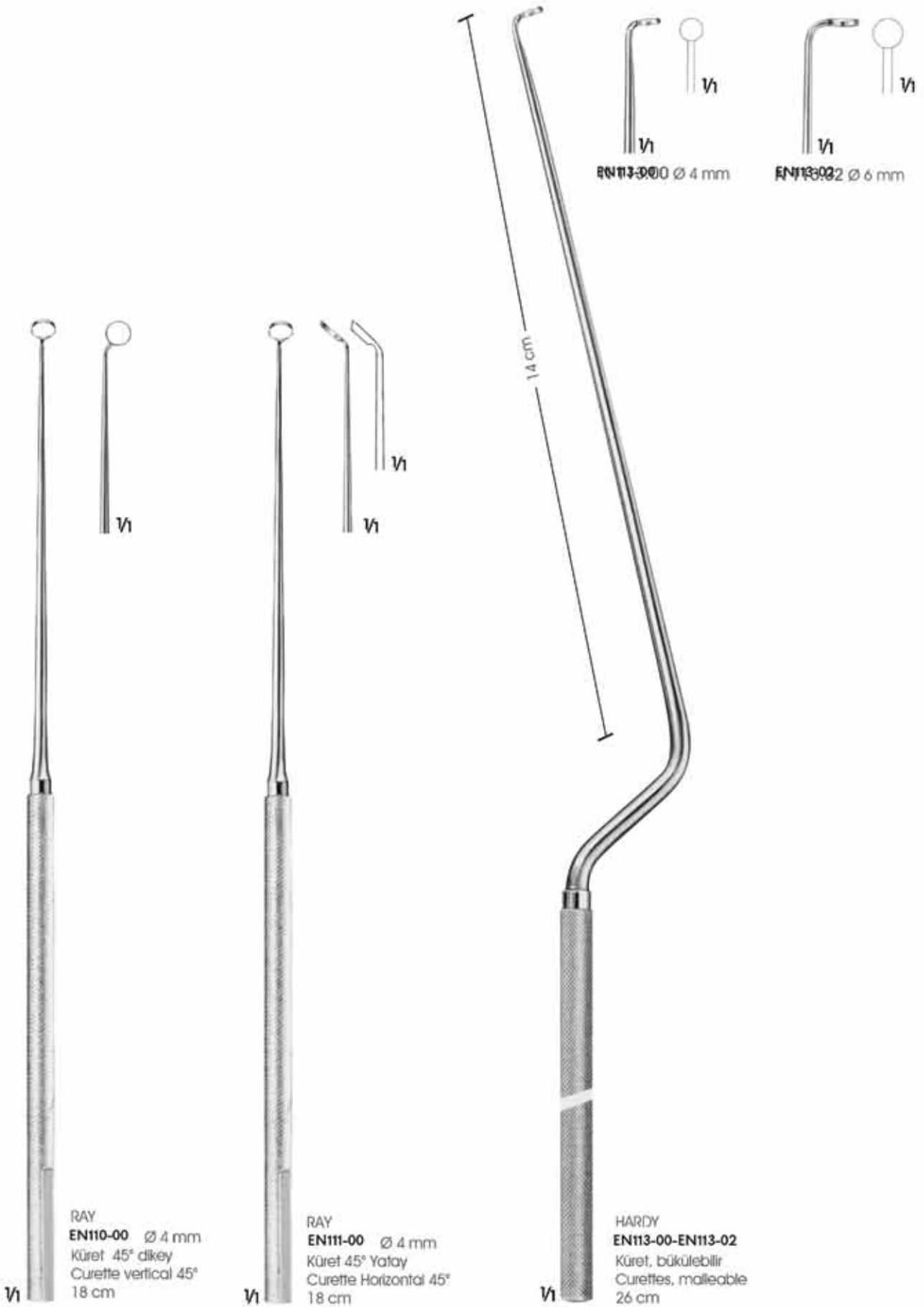

RAY
EN110-00 Ø 4 mm
Küret 45° dikey
Curette vertical 45°
18 cm

RAY
EN111-00 Ø 4 mm
Küret 45° Yatay
Curette Horizontal 45°
18 cm

HARDY
EN113-00-EN113-02
Küret, bükülebilir
Curettes, malleable
26 cm

EN113-000 Ø 4 mm

EN113-002 Ø 6 mm

14 cm

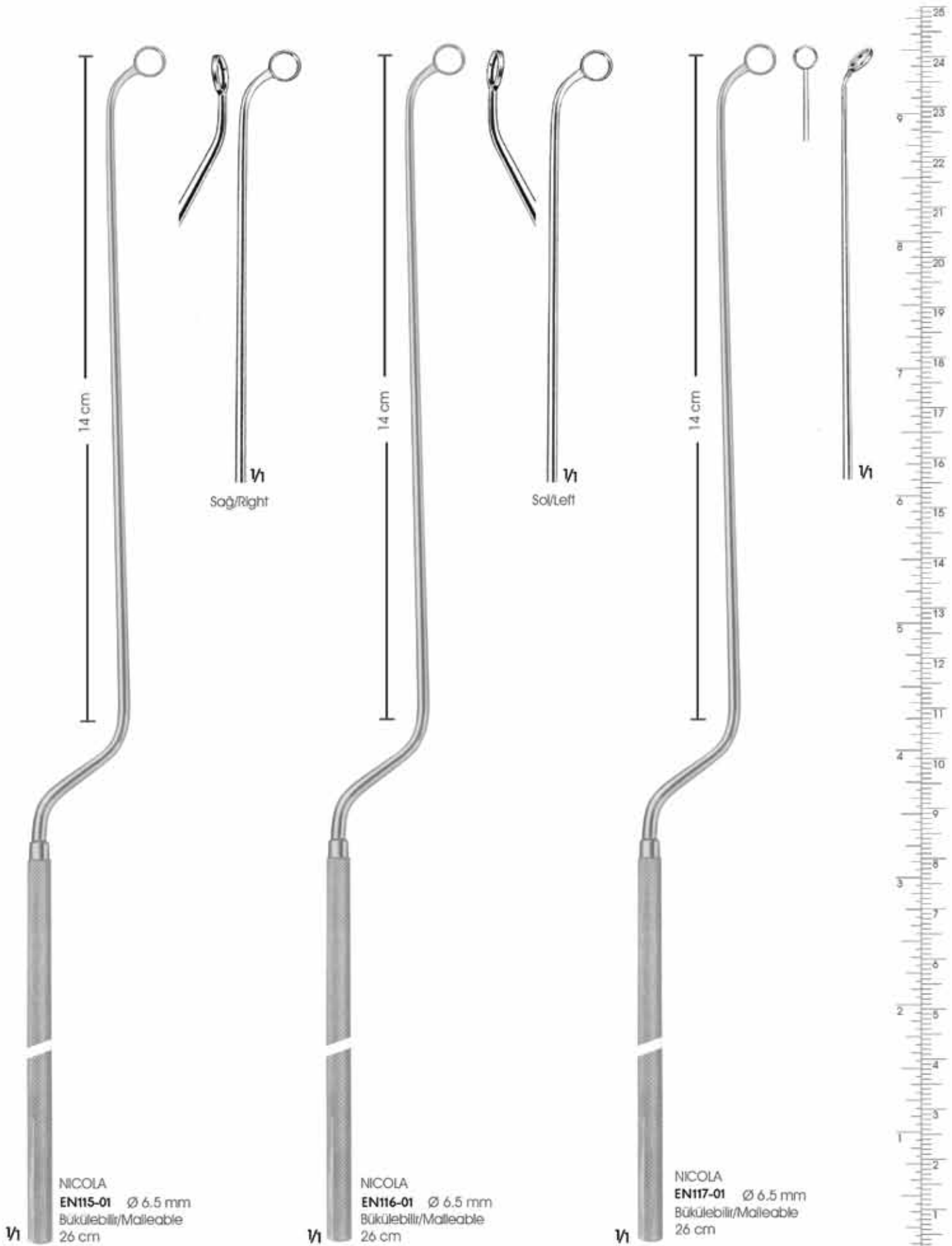



CLOWARD
EL490-01
Sadece ekartör
Retractor only
25 cm



CLOWARD
EL491-00
Sadece ekartör
Retractor only
15 cm

CLOWARD
EL490-00 Komple/Complete
EL490-01
EL490-05-EL491-09

CLOWARD
EL491-01 Komple/Complete
EL491-00
EL491-05-EL491-09

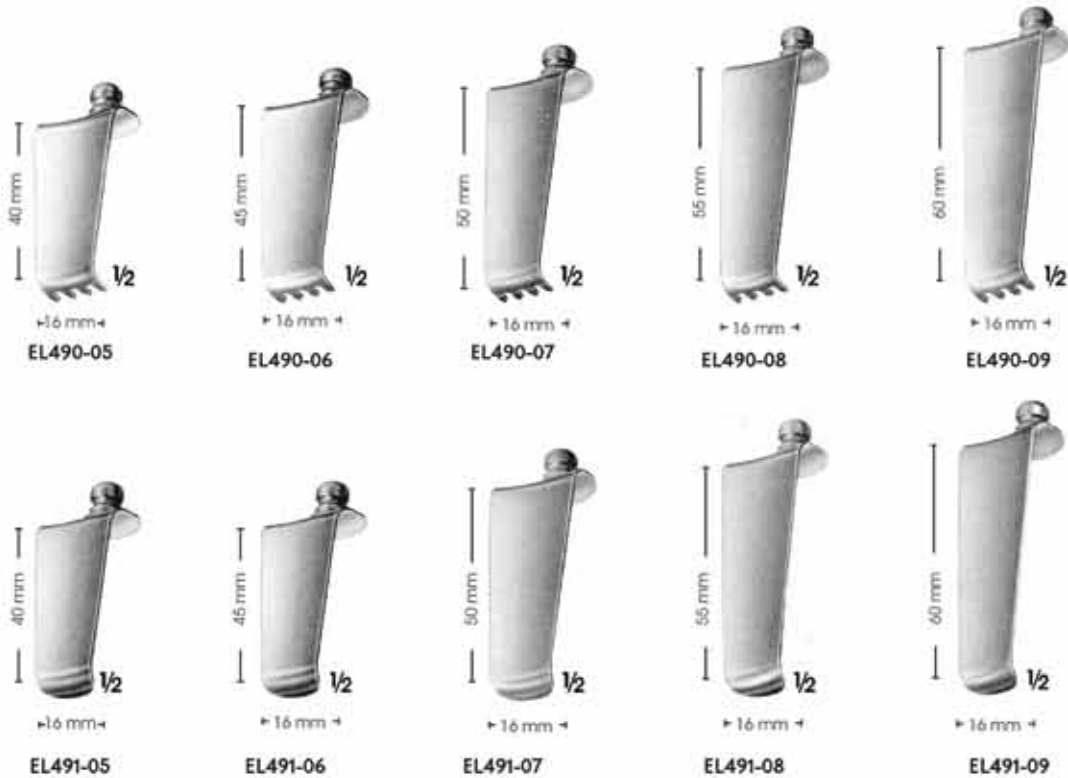

40 mm
1/2
16 mm
EL490-05

45 mm
1/2
16 mm
EL490-06

50 mm
1/2
16 mm
EL490-07

55 mm
1/2
16 mm
EL490-08

60 mm
1/2
16 mm
EL490-09

40 mm
1/2
16 mm
EL491-05

45 mm
1/2
16 mm
EL491-06

50 mm
1/2
16 mm
EL491-07

55 mm
1/2
16 mm
EL491-08

60 mm
1/2
16 mm
EL491-09



CLOWARD
EL494-00
15.5 cm



CLOWARD
EL495-00
13.5 cm



INGE
EL497-00
17 cm

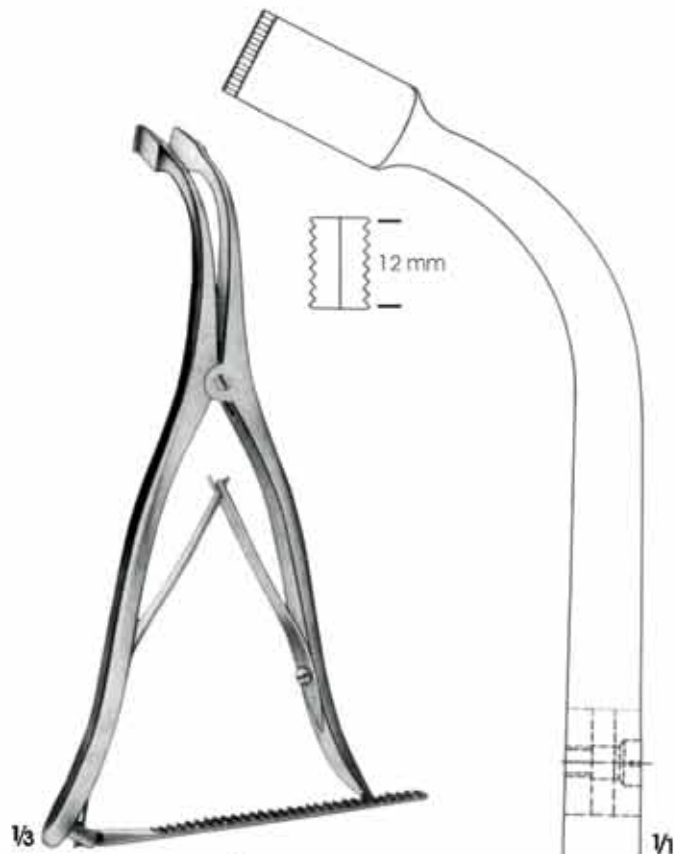

INGE
EL498-00
27.5 cm



CLOWARD
EK552-00 18 mm
EK552-01 20 mm
EK552-02 23 mm
18 cm



CLOWARD
EK557-00
Koter huku/Coutery hook
20 cm



CLOWARD
EK555-00
10 x 8 mm
19 cm



CLOWARD
EK554-00
20 x 12 mm
20 cm



1/2

CLOWARD
EM814-01 230 gr.
19 cm



CLOWARD
EM567-00 5 mm
EM567-01 8 mm
EM567-02 10 mm
EM567-04 12 mm
20 cm

4 mm



CLOWARD
EM569-00
18 cm



CLOWARD
EM568-00
20 cm



**CLOWARD
ET470-00**
Graft alma kolu
Dowel cutter shaft
16.5 cm



ET471-00
Ø 12 mm



ET471-01
Ø 14 mm



ET471-02
Ø 16 mm



ET471-03
Ø 18 mm

ET471-00-ET471-03
Graft alma matkapları
Dowel cutters



ET472-00
Ø 12 mm



ET472-01
Ø 14 mm



ET472-02
Ø 16 mm



ET472-03
Ø 18 mm

ET472-00-ET472-03
Merkezi pimler
Dowel center pins



ET475-00
Çıkma başlığı
Dowel ejector



ET477-03
Ø 18 mm



ET477-02
Ø 16 mm



ET477-01
Ø 14 mm



ET477-00
Ø 12 mm

ET477-00-ET477-03
Graft tutma uçları
Dowel holders



ET478-00
Tutma kolu
Dowel handle



ET479-00
Anahtar
Wrench



ET481-00
Tutma kolu
Dowel handle
18 cm



ET481-01
Derinlik ölçer
Depth gauge
21 cm



ET482-00 Ø 9.5 mm
ET482-01 Ø 13 mm
Koruyucu kılavuz
Guard guide
19 cm



ET483-00
Ø 13 mm
Küçük/Small

ET483-01
Ø 16 mm
Büyük/Large

ET483-00-ET483-01
Matkap kolu
Drill shaft
14 cm



ET484-00 Ø 10 mm
ET484-01 Ø 12 mm
ET484-02 Ø 14 mm
ET484-03 Ø 16 mm

ET484-00-ET484-03
Matkap ucu/Drill tip



ET486-00 Ø 22 mm
Kol içi çapı
Handle inside diameter



ET487-00 Ø 13 mm
Küçük/Small
ET487-01 Ø 16 mm
Büyük/Large
Matkap koruyucu
Drill guard



ET488-00 Ø 25 mm
Matkap koruma başlığı
Drill Guard cap
3 mm





EL901-00
Sadece ekartör, V 644.00P ile birlikte
Retractor only, with key V 644.00P



EL644-00P
Tornavida/Screwdriver
15 cm

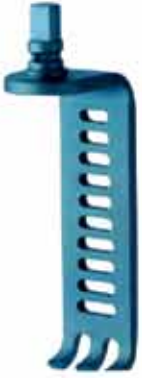

EL470-20T 20 x 35 mm
EL470-21T 20 x 40 mm
EL470-22T 20 x 45 mm
EL470-23T 20 x 55 mm
EL470-24T 20 x 65 mm
Titanyum bleydler
Blades titanium



EL470-30T 40 x 35 mm
EL470-31T 40 x 40 mm
EL470-32T 40 x 45 mm
EL470-33T 40 x 55 mm
EL470-34T 40 x 65 mm
EL470-35T 40 x 75 mm
Titanyum bleydler
Blades titanium



EL470-40T 60 x 35 mm
EL470-41T 60 x 40 mm
EL470-42T 60 x 45 mm
EL470-43T 60 x 55 mm
EL470-44T 60 x 65 mm
EL470-45T 60 x 75 mm
EL470-46T 60 x 85 mm
Titanyum bleydler
Blades titanium



EL463-50T
Hemi-Laminektomi huk, küçük 38 mm
Hemi-Laminectomy hook, small 38 mm



EL463-52T
Hemi-Laminektomi huk, büyük 58 mm
Hemi-Laminectomy hook, large 58 mm



ET995-00P
Ekartör bleydleri yerleştirme kolu
Handle for positioning of the
retractor blades



EL465-05
Çift hareketli Servikal ekartör
Doble hinged Cervical retractor



EL469-05
Çift hareketli karşı ekartör
Doble hinged retractor used for
longitudinal retraction



EL467-05
Karşı ekartör
Counter retractor



EL470-50T 30 x 24 mm
EL470-51T 35 x 24 mm
EL470-52T 40 x 24 mm
EL470-53T 45 x 24 mm
EL470-54T 50 x 24 mm
EL470-55T 55 x 24 mm
EL470-56T 60 x 24 mm
EL470-57T 65 x 24 mm
EL470-58T 70 x 24 mm
Titanyum orta bleydler
Medial blades titanium



EL471-50T 30 x 24 mm
EL471-51T 35 x 24 mm
EL471-52T 40 x 24 mm
EL471-53T 45 x 24 mm
EL471-54T 50 x 24 mm
EL471-55T 55 x 24 mm
EL471-56T 60 x 24 mm
EL471-57T 65 x 24 mm
EL471-58T 70 x 24 mm
Titanyum yan bleydler
Lateral blades titanium



EL472-50T 35 x 24 mm
EL472-51T 40 x 24 mm
EL472-52T 45 x 24 mm
EL472-53T 50 x 24 mm
EL472-54T 55 x 24 mm
EL472-55T 60 x 24 mm
EL472-56T 65 x 24 mm
EL472-57T 70 x 24 mm
EL472-58T 75 x 24 mm
Titanyum küt bleydler
Blunt blades titanium



EL474-50T 30 x 24 mm
EL474-51T 35 x 24 mm
EL474-52T 40 x 24 mm
EL474-53T 45 x 24 mm
EL474-54T 50 x 24 mm
EL474-55T 55 x 24 mm
EL474-56T 60 x 24 mm
EL474-57T 65 x 24 mm
EL474-58T 70 x 24 mm
Titanyum orta bleydler
Medial blades titanium



EL473-50T 30 x 24 mm
EL473-51T 35 x 24 mm
EL473-52T 40 x 24 mm
EL473-53T 45 x 24 mm
EL473-54T 50 x 24 mm
EL473-55T 55 x 24 mm
EL473-56T 60 x 24 mm
EL473-57T 65 x 24 mm
EL473-58T 70 x 24 mm
Titanyum yan bleydler
Lateral blades titanium



EL475-50T 35 x 24 mm
EL475-51T 40 x 24 mm
EL475-52T 45 x 24 mm
EL475-53T 50 x 24 mm
EL475-54T 55 x 24 mm
EL475-55T 60 x 24 mm
EL475-56T 65 x 24 mm
EL475-57T 70 x 24 mm
EL475-58T 75 x 24 mm
Titanyum küt bleydler
Blunt blades titanium



EL476-50T 25 x 19 mm
EL476-51T 30 x 19 mm
EL476-52T 35 x 19 mm
EL476-53T 40 x 19 mm
EL476-54T 45 x 19 mm
EL476-55T 50 x 19 mm
EL476-56T 55 x 19 mm
EL476-57T 60 x 19 mm
Titanyum dişli bleydler
Teeth blades titanium



EL477-50T 25 x 19 mm
EL477-51T 30 x 19 mm
EL477-52T 35 x 19 mm
EL477-53T 40 x 19 mm
EL477-54T 45 x 19 mm
EL477-55T 50 x 19 mm
EL477-56T 55 x 19 mm
EL477-57T 60 x 19 mm
Titanyum küt bleydler
Blunt blades titanium



ET995-00P
Bleyd tutucu elçek
Handle for blades with side load
attachment



EOR Ortopedik Cerrahi
Orthopedic Surgery



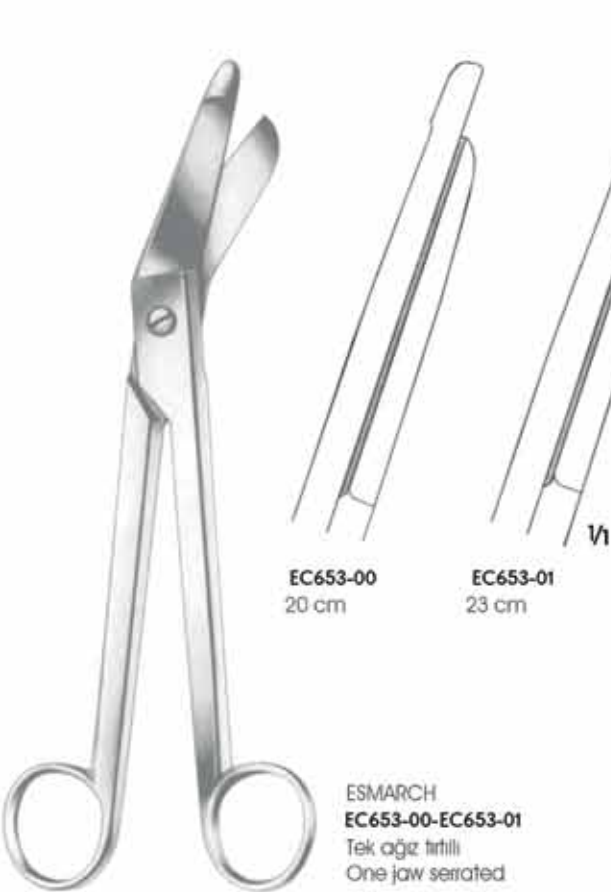
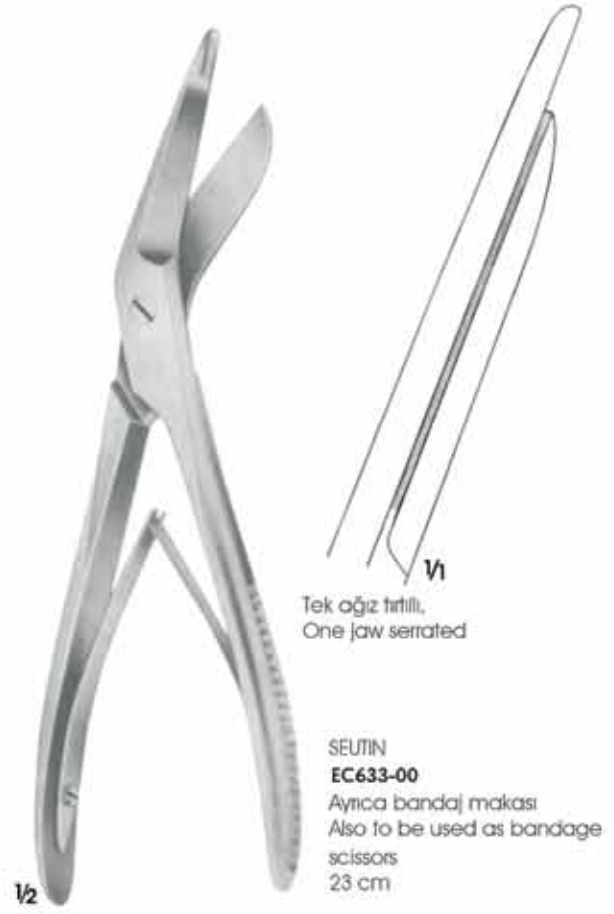



1/2

ESMARCH
EB175-00
Alçı bıçağı
Plaster knife
18 cm



1/2

ENGEL
ET605-00
Alçı testeresi
Plaster saw
15 cm



1/2

BRUNS
EC656-00
23.5 cm

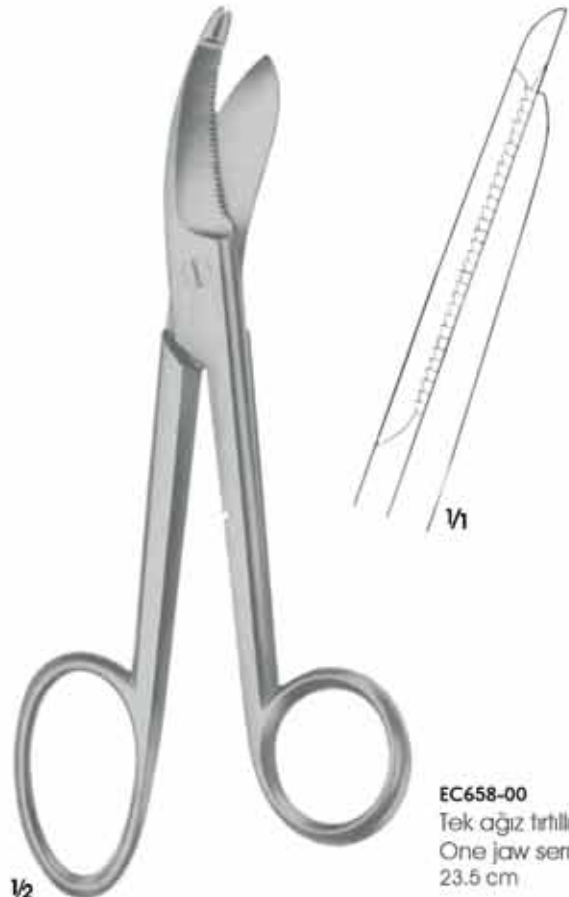

1/2

EC658-00
Tek ağız tırnıklı
One jaw serrated
23.5 cm





STILLE
EC882-00
23 cm



STILLE
EC884-00
26 cm



STILLE
EC885-00
36 cm



STILLE
EC886-00
37 cm



EP600-00
Alçı ayırıcı
Plaster shear
23 cm



HENNIG
EP602-00
Alçı ayırıcı
Plaster shear
27 cm



WOLFF
EP608-00 18 cm
EP608-02 24 cm
Alçı kesiciler
Plaster breakers



EP605-00
Alçı ayırıcı
Plaster shear
29 cm



Sökülebilir çeneli
With removable jaws





ES550-00

Ayarlı küçük boy, üç kancalı traksiyon aleti
Wire traction bow, adjustable, with 3 hooks,
small size

ES558-00 Uygun anahtar
ES558-00 Suitable wrench



ES551-00

Ayarlı küçük boy, üç kancalı traksiyon aleti
Wire traction bow, adjustable, with 3 hooks,
small size

ES558-00 uygun anahtar
ES558-00 suitable wrench



ES550-01

Ayarlı büyük boy, üç kancalı traksiyon aleti
Wire traction bow, adjustable, with 3 hooks,
large size

ES558-00 Uygun anahtar
ES558-00 Suitable wrench

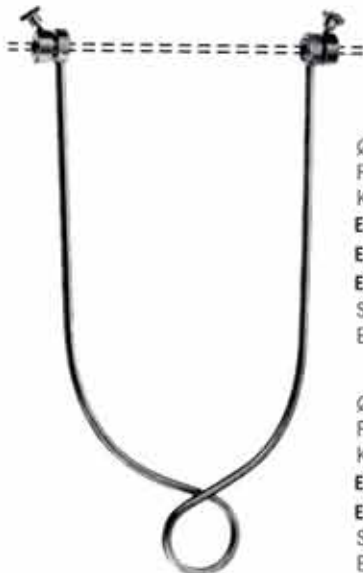

Ø 4 mm STEINMANN çivileri için
For Ø 4 mm STEINMANN pins
Kol ölçüleri/Arms dimensions

ES560-01 16 x 9 cm

ES560-03 21 x 11 cm

ES560-05 21 x 15 cm

STEINMANN çivileri hariç
Except for STEINMANN pins

Ø 5 mm STEINMANN çivileri için
For Ø 5 mm STEINMANN Pins
Kol ölçüleri/Arms dimensions

ES560-07 16 x 9 cm

ES560-08 21 x 11 cm

STEINMANN çivileri hariç
Except for STEINMANN pins



ES557-03

Sabitleme diskleri için tomavida
Screw driver for fixation discs



ET792-00 1 kg

ET792-01 2 kg

ET792-02 5 kg

Ağırlık/Weight



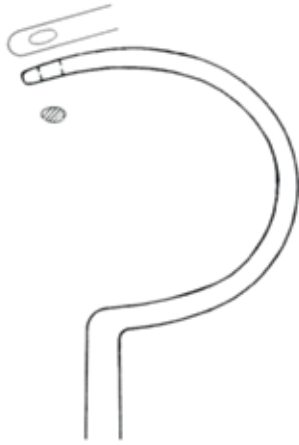

EF530-01
27.5 cm

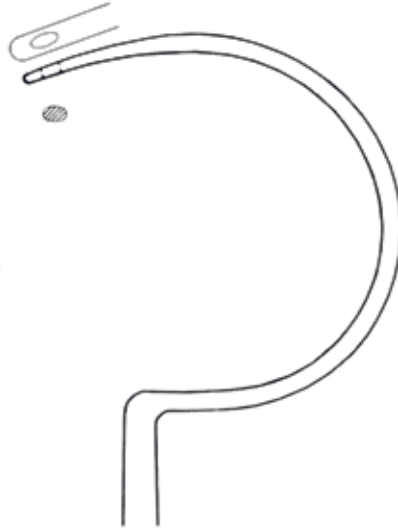

EF530-02
28.5 cm

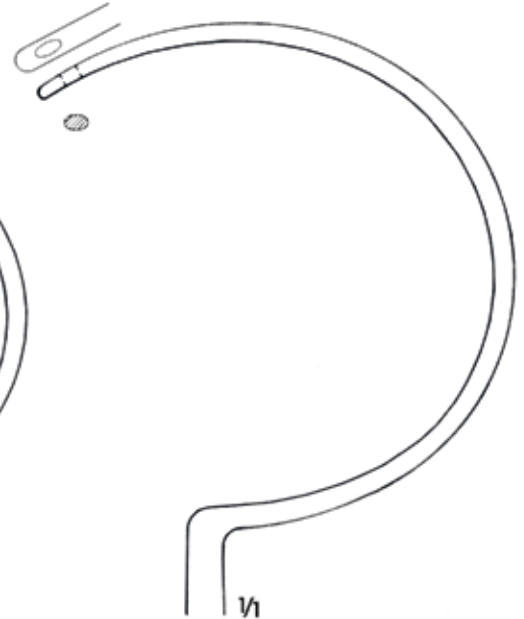

EF530-03
30.5 cm

DEMEL
EF530-01-EF530-03
Tel kılavuzları/Wire guides



EF531-01-EF531-03

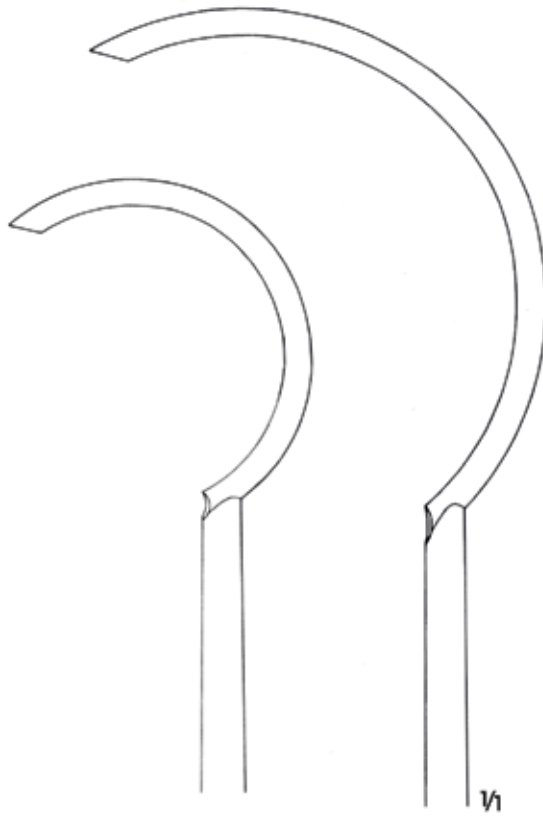

EF531-01
24 cm

EF531-03
27 cm

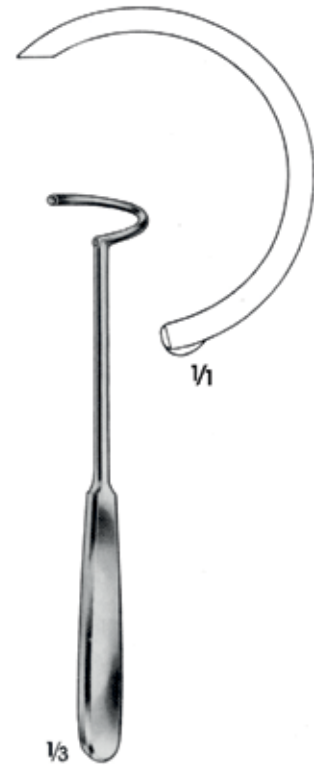

EF532-01
22.5 cm



EF529-00-EF529-10

Yumuşak doku uyumlu tel 10 m
Wire, soft, tissue compatible, in coils of 10 m

EF529-00	Ø 0.2 mm	EF529-03	Ø 0.5 mm	EF529-06	Ø 0.8 mm	EF529-09	Ø 1.2 mm
EF529-01	Ø 0.3 mm	EF529-04	Ø 0.6 mm	EF529-07	Ø 0.9 mm	EF529-10	Ø 1.5 mm
EF529-02	Ø 0.4 mm	EF529-05	Ø 0.7 mm	EF529-08	Ø 1.0 mm		

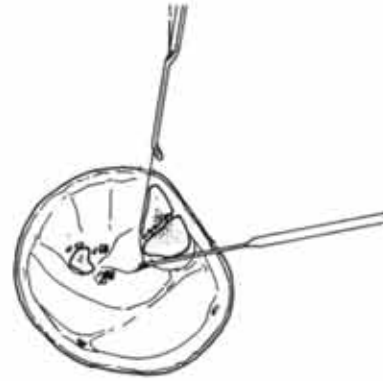
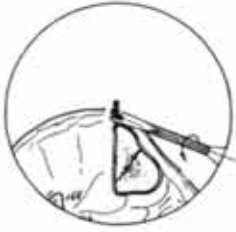

İmplantlar için kullanılan malzemeden yapılmış hareketli uç. Bükülürken hareketli başlık sabit kalır bu sayede tel kalmaz.
Movable tip made of material used for implants. While twisting the movable head remains stable, therefore the wire will not slip off.

1/2

LOUTE
EF520-00

Tel gerici, geliştirilmiş model, hareketli uç ile 1,0 mm çapına kadar olan teller için
Wire tightener, improved pattern, with movable tip, for wires up to 1.0 mm diam
22 cm

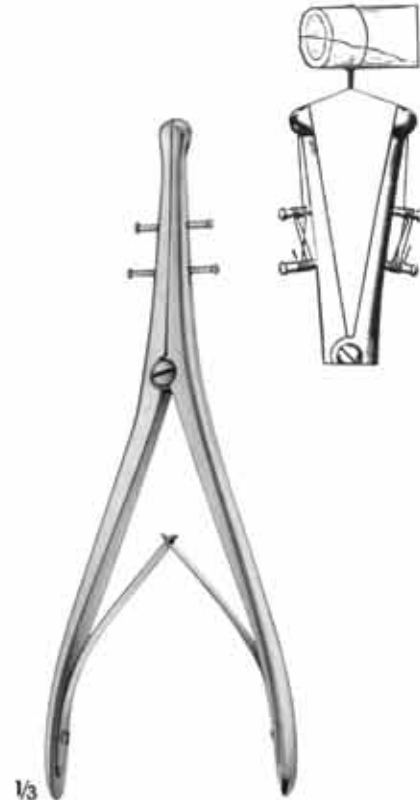

1/3

DEMEL
EF522-00

Gerdirek tel sıkma, büküm pensli
Wire tightening-and twisting forceps
27 cm



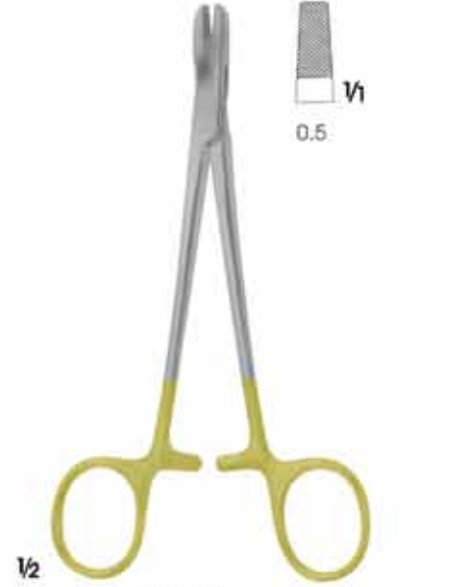



$\frac{1}{2}$
BAUMGARTNER
EF339-01
Tel bukücü/Wire twister
Bağlama pensisi/Ligature forceps
20 cm

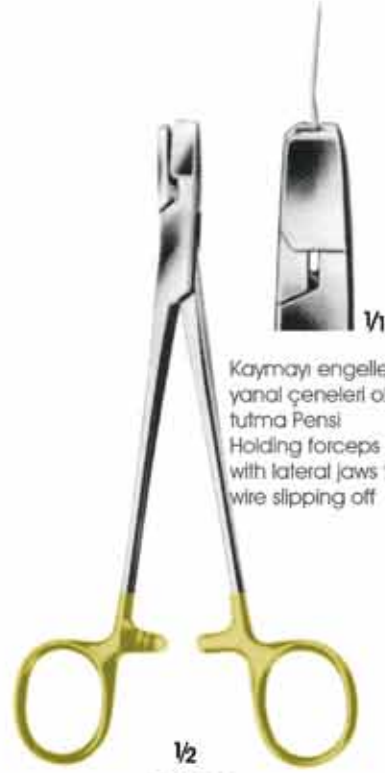

$\frac{1}{2}$
EP610-00
17 cm

Kaymayı engellemek için
yanal çeneleri olan serkaj telli
tutma Pensi
Holding forceps for cerclage wire,
with lateral jaws to avoid
wire slipping off





MARBURG MODELL
EP611-00
Tel tutma pensli,
Düz burunlu, tırtıllı ağız
Wire holding forceps,
Flat nosed, with serrated jaws
14 cm

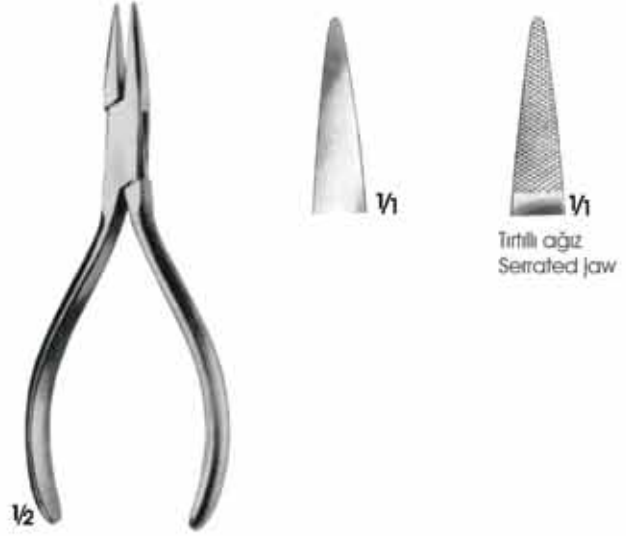

GOSLEE
EP617-00
Tel bükücü, düz burunlu
Wire twister, flat nosed
14 cm



EP612-00-EP613-00
Tel bükücü, düz burunlu
Wire twister, flat nosed
17 cm



EP612-00
Tırtıllı ağız
With serrated jaws



EP613-00
Boylamasına ve
çapraz kanallı
With longitudinal
and transversal
grooves



EP627-00
19.5 cm



EP614-00
Tel tutma pensli, düz burunlu
Wire holding forceps, flat nosed
19 cm



EP615-00-EP616-00
Tel çıkarma pensli
Extraction pliers for boring
wires



EP615-00
13 cm



EP616-00
18 cm



EP619-01
Yuvarlak Burun Kıskaçları İnce
Model
Round Pliers
Delicate Pattern
14 cm



EP619-02
Tel İçin Tel Bükme Kıskaçları
Wire Bending Pliers
13.5 cm



SCHWARZ
EP619-03
Teller İçin Tel Bükme Kıskaçları
Wire Bending Pliers
For Bending Loops
13.5 cm





EP618-01
Yuvarlak pens
Round pliers
18 cm

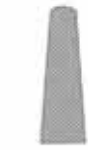

EP618-02
Tel çıkartıcı pens
for wires
18 cm



EP618-05
Tel çıkartıcı pens
Extraction pliers for
wires
14.5 cm



EP618-03
Tel çıkartıcı pens
Extraction pliers for
wires
18 cm



1/2

EP620-00
Ø 1.8 mm kadar teller için
bükme pens
Bending pliers for wires up to
1.8 mm diam.

EP618-01-EP618-05



1/2

EP621-00
Paralel düz tutucu
Flat-nosed pliers, parallel
18.5 cm



1/1



1/2

EP625-00
Mengene kavramalı, ayarlı pense
Vise grip pliers set
20 cm



Özel sertleştirilmiş kesici ağız
Specially hardened cutting edges



Özel sertleştirilmiş kesici ağız
Specially hardened cutting edges



Yumuşak tel için Ø 0.5 mm
For soft wire Ø 0.5 mm
Sert tel için Ø 0.3 mm
For hard wire Ø 0.3 mm

1/2

ANGLE
EP630-00
13 cm



Yumuşak tel için Ø 0.6 mm
For soft wire Ø 0.6 mm
Sert tel için Ø 0.4 mm
For hard wire Ø 0.4 mm

1/2

EP630-01
13 cm



Yumuşak tel için Ø 1.5 mm
For soft wire Ø 1.5 mm
Sert tel için Ø 1.0 mm
For hard wire Ø 1.0 mm

1/2

EP632-00
Tel kesme pens
Wire cutting pliers
14 cm



Sert metal kesici ağız
Tungsten carbide cutting edges



Yumuşak tel için Ø 1.2 mm
For soft wire Ø 1.2 mm
Sert tel için Ø 0.8 mm
For hard wire Ø 0.8 mm

1/2

EC798-00
Tek ağız tırtilli
One jaw serrated
12 cm

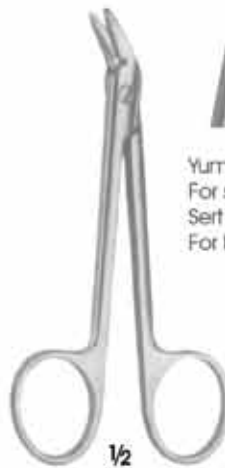

Yumuşak tel için Ø 1.2 mm
For soft wire Ø 1.2 mm
Sert tel için Ø 0.6 mm
For hard wire Ø 0.6 mm

1/2

EC668-00
Tek ağız tırtilli
One jaw serrated
12 cm

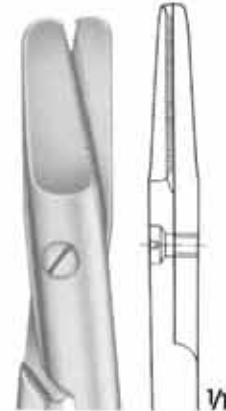
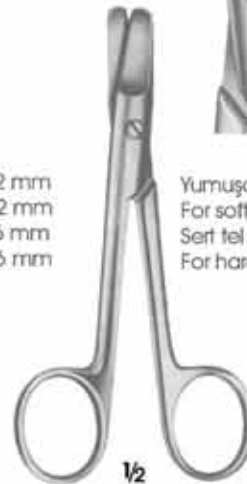

Yumuşak tel için Ø 0.4 mm
For soft wire Ø 0.4 mm
Sert tel için Ø 0.3 mm
For hard wire Ø 0.3 mm

1/2

HARVEY
EC666-00
Çift ağız tırtilli
Both jaws serrated
12.5 cm





EP635-00
16 cm



V1

Yumuşak tel için Ø 1.5 mm
For soft wire Ø 1.5 mm
Sert tel için Ø 1.2 mm
For hard wire Ø 1.2 mm



EP634-00
15 cm



V1

Yumuşak tel için Ø 1.5 mm
For soft wire Ø 1.5 mm
Sert tel için Ø 1.0 mm
For hard wire Ø 1.0 mm



EP639-00
Sternum dikişinden sonra tel çıkartılması için açılı narın yapı
Angled slender pattern for wire removal after sternum suture
17 cm



V1

Yumuşak tel için Ø 0.9 mm
For soft wire Ø 0.9 mm
Sert tel için -
For hard wire -

Özel sertleştirilmiş kesici ağız
Specially hardened cutting edges

Özel sertleştirilmiş kesici ağız
Specially hardened cutting edges



HARVEY
EP649-05
Tel kesme pens
Wire cutting pliers
23 cm



V1

Yumuşak tel için Ø 3.0 mm
For soft wire Ø 3.0 mm
Sert tel için Ø 2.2 mm
For hard wire Ø 2.2 mm



EP643-00
Yanal kesme
Lateral cutting
23.5 cm



V1

Yumuşak tel için Ø 3.0 mm
For soft wire Ø 3.0 mm
Sert tel için Ø 2.2 mm
For hard wire Ø 2.2 mm



Ozel sertleştirilmiş kesici ağız
Specially hardened cutting edges



Yumuşak tel için Ø 2.0 mm
For soft wire Ø 2.0 mm
Sert tel için Ø 1.5 mm
For hard wire Ø 1.5 mm

REILL
EP640-00
Kemiğe yakın olan
telleri kesme
For cutting off wires close
to the bone
17.5 cm



Yumuşak tel için Ø 2.0 mm
For soft wire Ø 2.0 mm
Sert tel için Ø 1.5 mm
For hard wire Ø 1.5 mm

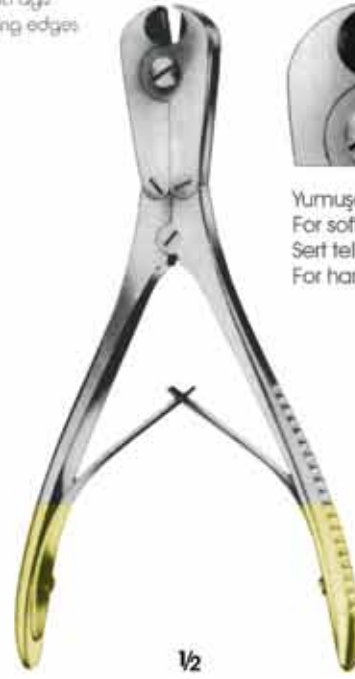

EP641-00
Tel kesiciler, ön ve yan kesme
hareketli
Wire cutters, front-and lateral
cutting action
18 cm



Ozel sertleştirilmiş kesici ağız
Specially hardened cutting edges



Yumuşak tel için Ø 3.0 mm
For soft wire Ø 3.0 mm
Sert tel için Ø 2.2 mm
For hard wire Ø 2.2 mm

HARVEY
EP649-00
Tel kesme pensli
Wire cutting pliers
23.5 cm



Sert metal kesici ağız
Tungsten carbide cutting edges



Yumuşak tel için Ø 2.5 mm
For soft wire Ø 2.5 mm
Sert tel için Ø 2.0 mm
For hard wire Ø 2.0 mm

EP645-00
Tel kesme pensli
Wire cutting pliers
24 cm





Yumuşak tel için Ø 2.0 mm
For soft wire Ø 2.0 mm
Sert tel için Ø 1.5 mm
For hard wire Ø 1.5 mm

EP647-00
14.5 cm



Yumuşak tel için Ø 1.5 mm
For soft wire Ø 1.5 mm
Sert tel için Ø 1.0 mm
For hard wire Ø 1.0 mm

EP650-00
14.5 cm



Yumuşak tel için Ø 3.5 mm
For soft wire Ø 3.5 mm
Sert tel için Ø 2.5 mm
For hard wire Ø 2.5 mm

EP651-00
16.5 cm



Yumuşak tel için Ø 3.0 mm
For soft wire Ø 3.0 mm
Sert tel için Ø 2.0 mm
For hard wire Ø 2.0 mm

EP648-00
22 cm



EP652-00

Ø 3 mm kadar tel, vida, çivi vs. kesmek için
For cutting off wires, screws, pins, etc. up to Ø 3 mm
32 cm



EP655-00

Ø 6 mm kadar tel, vida, çivi vs. kesmek için
For cutting off wires, screws, pins, etc. up to Ø 6 mm
47 cm



143° buhar sterilizatörlerinde steril edilebilir.
Can be sterilized in a steam sterilizer up to 143°



1/2

OBWEGESER
EF458-00
19.5 cm

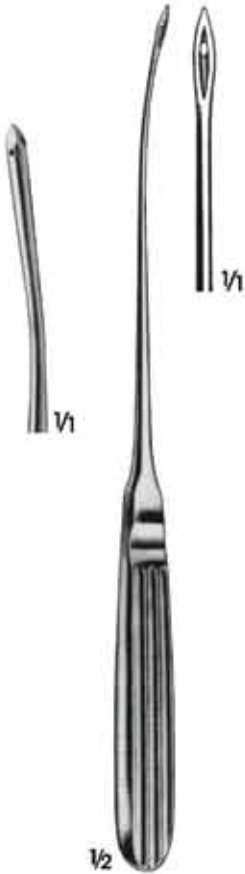

1/2

OBWEGESER
EF457-00
23 cm



1/2

EF460-00
Bükülebilir/Malleable
23 cm

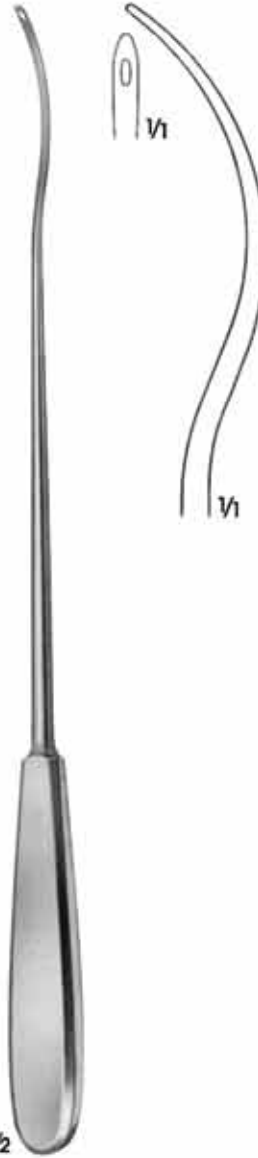

1/2

BRUNNER
EF466-00
30 cm



1/2

WAGNER
EF533-00
Tel uzatma/Wire extension
30 cm



EV600-00
Oyucu (Biz)
Reamer (Awl)
18 cm



EV601-00
Oyucu (Biz)
Reamer (Awl)
21.5 cm



CHAMPIONNIERE
EV607-00
Kemik matkabı
Bone drill
17 cm



EV599-00
Oyucu (Biz)
Reamer (Awl)
15 cm





EV554-01
Delme başlığı
Drilling chuck
Ø 0,8-2 mm
15 cm



EV608-00
Delme başlığı Ø 4,5 mm
Drilling chuck Ø 4,5 mm
V 606.02 anahtarı ile
With key V 606.02
14 cm



EV609-00
Delme başlığı Ø 6,35 mm
Drilling chuck Ø 6,35 mm
V 606.01 anahtarı ile
With key V 606.01
16 cm



EV606-01
Anahtar/Key



EV606-00
Anahtar/Key



EV605-00
V 606.00 Anahtarı ile
With key V 606.00

İç çap/inside Ø 6,7 mm
Dış çap/Outside Ø 8,7 mm



EV603-00

İç çap/inside Ø 3,9 mm
Dış çap/Outside Ø 5 mm

EV603-01

İç çap/inside Ø 6,4 mm
Dış çap/Outside Ø 8 mm

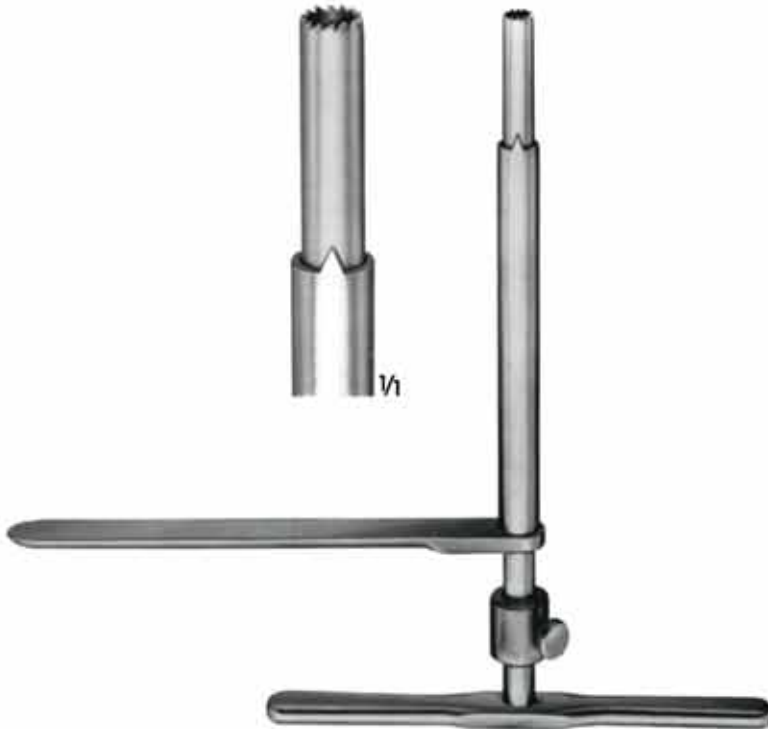

R.N.O.H.
EV704-05
Kemik biyopsi trapanı
Bone biopsy trephine
19,5 cm



EV603-00-EV603-01
Kemik biyopsi trapanı
Bone biopsy trephine
16 cm





BUNNEL
EV615-00

Küçük el matkabi, KIRSCHNER tel için delikli küçük el matkabi, 3 çene ağızlı, 4 mm çaplı başlıklar için uygundur.
Small hand drill, canullated for KIRSCHNER wires, with 3-jaw chuck to fit any size of shanks up to 4.0 mm diameter,
V 606.02 anahtarı ile
With key V 606.02
16 cm



EV606-02
Anahtar/Key



Ayarlı sap
Adjustable handle

EV612-00
El matkabi/Hand drill only
28 cm

El matkabi paslanmaz, 3 çene ağızlı, 6.35 mm çaplı başlıklar için uygundur. Orjinal 'Jacops Chuck' aynaları ile ve EV606-01 anahtarı ile, anahtarı veya anahtarsız kullanılabilir.
Hand drill, stainless, original 'Jacops Chuck' and key EV606-01
Can be used with or without the key.



EV606-01
Anahtar/Key

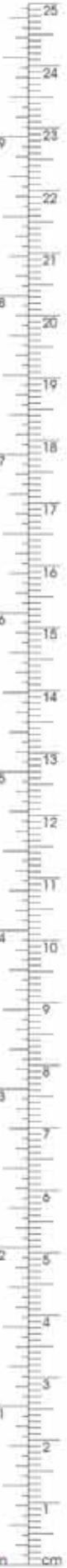



EV623-01
20 cm

EV623-03
25 cm



EV622-01
20 cm

EV622-03
25 cm



EV621-01
20 cm

EV621-03
25 cm



EV621-02
20 cm

EV621-05
25 cm



EV620-02
20 cm

EV620-05
25 cm



EV620-01
20 cm

EV620-04
25 cm

3.5 mm

2.5 mm



EV645-01
Ø 2.7 mm
15 cm

EV645-02
Ø 3.5 mm
17 cm

EV645-03
Ø 4.0 mm
20 cm

EV645-04
Ø 4.5 mm
22 cm

EV645-01-EV645-04
Kemik tapları/Bone taps



Ölçme sınırı
Measuring
6 - 40 mm

Vidalar için
For screws
Ø 2.7 mm
Ø 3.5 mm
Ø 4.0 mm

EV649-00
15.5 cm



Ölçme sınırı
Measuring
10 - 60 mm

Vidalar için
For screws
Ø 4.5 mm
Ø 6.5 mm

EV648-00
22 cm



ET616-00
Plak tutucu pens
Plate holding forceps
20 cm



Elmas Keski Ağız
With Carbide Cutting Edges



1/2

REILL

EPV640-00

Kemiğe yakın olan telleri kesme
For cutting off wires close to the bone
17.5 cm



1/1

Yumuşak tel için Ø 2.0 mm
For soft wire Ø 2.0 mm
Sert tel için Ø 1.5 mm
For hard wire Ø 1.5 mm



1/1

Düz ağız
Smooth jaw

1/2

GOSLEE

EP617-00

Tel bükücü, düz burunlu
Wire twister, flat nosed
14 cm



1/1

Tırnıklı ağız
Serrated jaw



EP683-00

15 cm



EV750-00
1.5 mm



EV752-00
20 cm

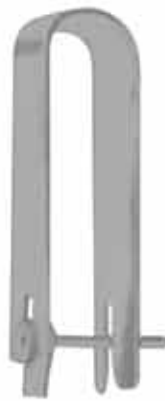

EV754-04
V 754.05-V 754.06
ile kullanılır.
To be use with
V 754.05 and V 754.06



EV754-00
Kılavuz/Guide
23 cm



EV754-05
Ø 2.5 mm



EV754-06
Pin/Pin





ET622-00
Bükme kolu
Bending Iron
14 cm



ET622-01
Bükme kolu
Bending Iron
14 cm



ET621-00
Bükme kolu
Bending Iron
16 cm



JEWETT
ET623-00
Bükme kolu
Bending Iron
20 cm



JEWETT
ET623-01
Bükme kolu
Bending Iron
20 cm



ET625-00
Bükme ve kıvrma aparatı
Plate bending and contouring device



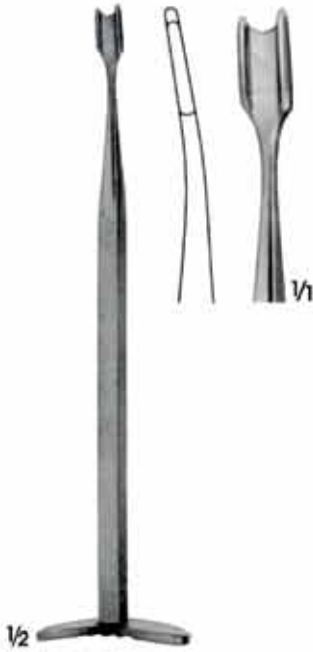

SMILLIE
EB515-00
Menisküs bıçak
Meniscus knife
17 cm

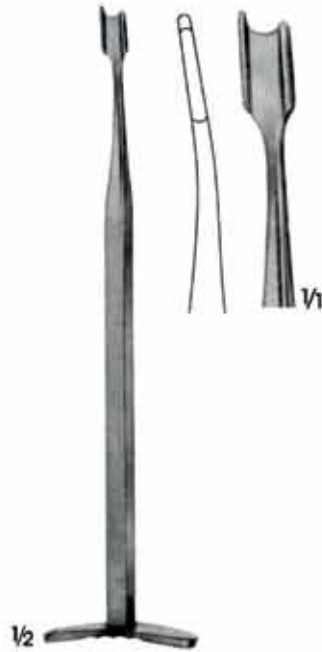

SMILLIE
EB516-00
Menisküs bıçak
Meniscus knife
17 cm

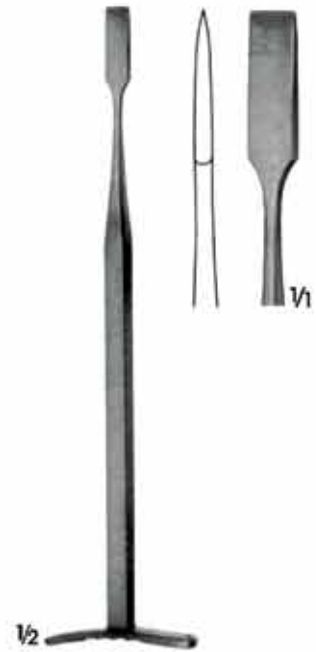

SMILLIE
EB517-00
Menisküs bıçak
Meniscus knife
17 cm

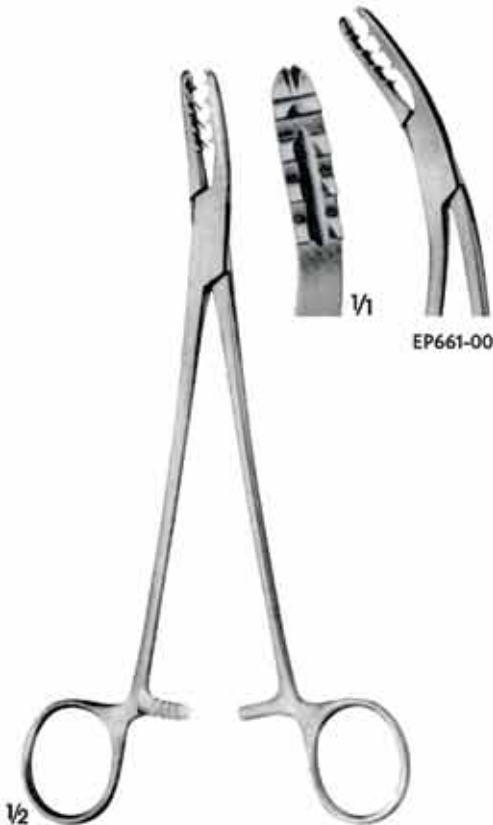

BIRCHER-GANSKE
EP660-00-EP661-00
Menisküs pensli
Meniscus forcep
20 cm

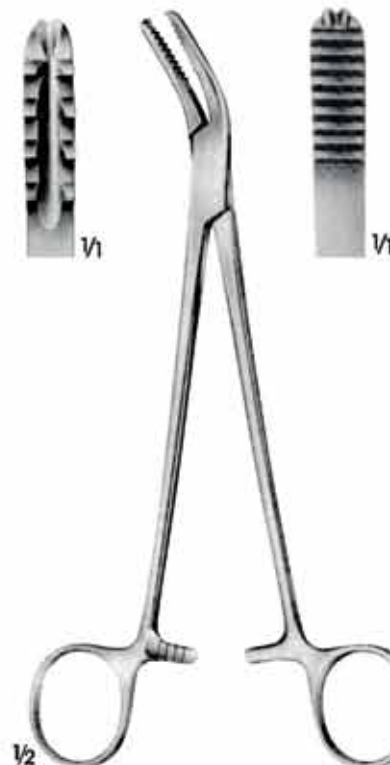

WELLER
EP662-00
Menisküs pensli
Meniscus forcep
20 cm



EP664-00
Menisküs pensli
Meniscus forcep
20.5 cm



1/2
 SMILLIE
 EK470-00-EK470-04
 14 cm



1/2 1/1
 EK470-00
 12 x 13 mm



1/2 1/1
 EK470-01
 32 x 19 mm



1/2 1/1
 EK470-02
 48 x 19 mm



1/2 1/1
 EK470-03
 57 x 19 mm



1/2 1/1
 EK470-04
 52 x 13 mm

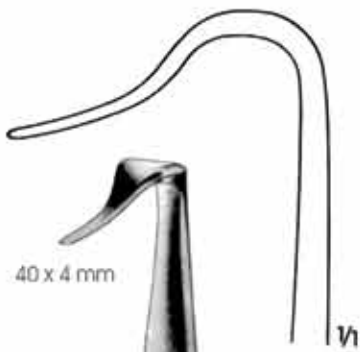

40 x 4 mm

1/2
 BLOUNT
 EK477-00
 17.5 cm

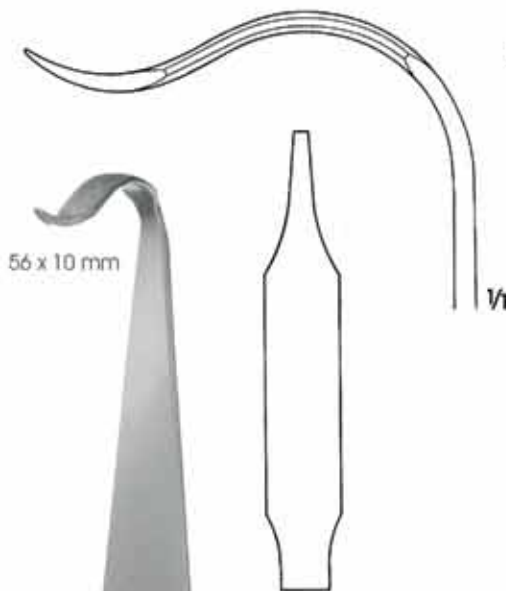

56 x 10 mm

1/2
 EK475-00
 17 cm



38 x 9 mm

1/2
 EK479-00
 22.5 cm

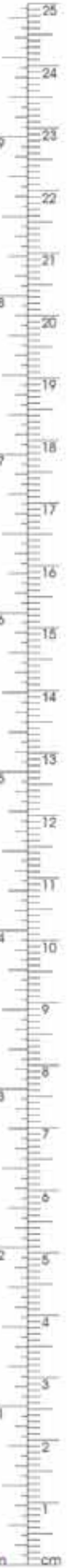



KUNTSCHER
EV725-06 Ø 6 mm
EV725-07 Ø 7 mm
EV725-08 Ø 8 mm
EV725-09 Ø 9 mm
EV725-10 Ø 10 mm
EV725-11 Ø 11 mm
EV725-16 Ø 12 mm
EV725-16 Ø 13 mm
EV725-16 Ø 14 mm
EV725-16 Ø 15 mm
EV725-16 Ø 16 mm
Sabit oyucu
Fixed reamer
50 cm



KUNTSCHER
EV727-06 Ø 6 mm
EV727-07 Ø 7 mm
EV727-08 Ø 8 mm
EV727-09 Ø 9 mm
EV727-10 Ø 10 mm
EV727-11 Ø 11 mm
EV727-16 Ø 12 mm
EV727-16 Ø 13 mm
EV727-16 Ø 14 mm
EV727-16 Ø 15 mm
EV727-16 Ø 16 mm
Bükülebilir oyucu
Malleable reamer
48 cm



KUNTSCHER
ET729-00
"T" kolu,
bükülebilir oyucular için
"T" Wrench, for malleable
reamers

ET711-00
Çıkartıcı/Extractor
25 cm



ET712-00
Çıkartıcı/Extractor
27 cm



ET701-00
İtici/Pusher
25 cm



MORE
ET714-00
Protez çıkartıcı
Protheses extractor
50 cm

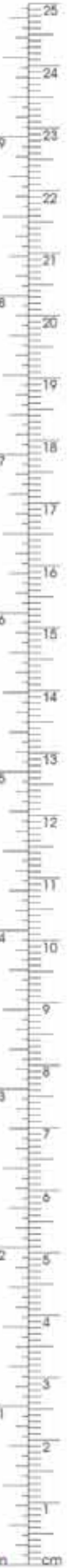



CHARNLEY
EL895-00

Kalça ekartörü takım
Hip retractor complete set

EL895-01

Kalça ekartör çemberi
Hip retractor frame, 300 x 240 mm

EL795-00

Traksiyon için zincirli ağırlık
Weight with chain, 1.740 g

EL890-01

Bleyd / Blade 60 mm, 37 x 25 mm

EL892-01

Bleyd / Blade 175 mm, 42 x 25mm



EL895-01
300 x 240 mm



CHARNLEY

Bleyd / Blade 60 mm

EL890-00 25 x 25 mm

EL890-01 37 x 25 mm

EL890-02 51 x 25 mm

EL890-03 57 x 25 mm

EL890-04 64 x 25 mm

EL890-05 76 x 25 mm

EL890-06 102 x 25 mm

EL890-07 114 x 25 mm

EL890-08 127 x 25 mm

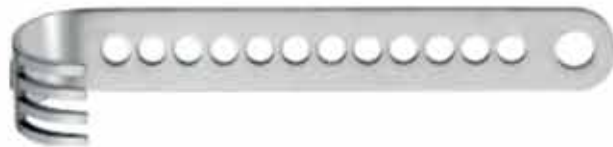

CHARNLEY

Bleyd / Blade

EL892-00 25 x 25 mm, 174 mm

EL892-01 42 x 25 mm, 174 mm

EL892-02 51 x 25 mm, 198 mm

EL892-03 57 x 25 mm, 192 mm

EL892-04 65 x 25 mm, 183 mm

EL892-05 76 x 25 mm, 174 mm

EL892-06 102 x 25 mm, 174 mm

EL892-07 114 x 25 mm, 174 mm

EL892-08 127 x 25 mm, 174 mm

EL890-08 127 x 25 mm, 174 mm



ET720-00
Çement İtici
Cement pusher
30 cm



ET721-00
Çement İtici
Cement pusher
30 cm



EM745-00-EM747-02
Osteotom ve guj
Chisel and gouge
35 cm



EM745-00
5 mm



EM746-00
5 mm



EM747-00
5 mm



EM745-01
7 mm



7 mm



EM747-01
7 mm



EM745-02
10 mm



EM746-02
10 mm



EM747-02
7 mm



Osteotom/Çizgi
Osteotome/Chisel



Guj/Gouge



Guj/Gouge

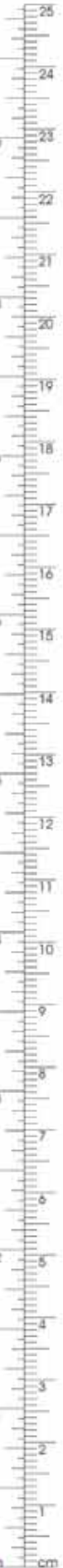



ER780-00
40 cm



EV735-00
Ø 6 mm
40 cm



EV736-00
Ø 8 mm
40 cm



EV737-00
Ø 10 mm
40 cm



ET725-00
Çekiç / Mallet
22 cm



ET726-00 Ø 7 mm
ET726-01 Ø 9 mm
ET726-02 Ø 11 mm
Çement çıkarıcı
Cement extractor
60 cm

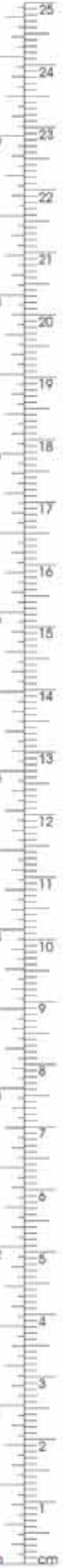

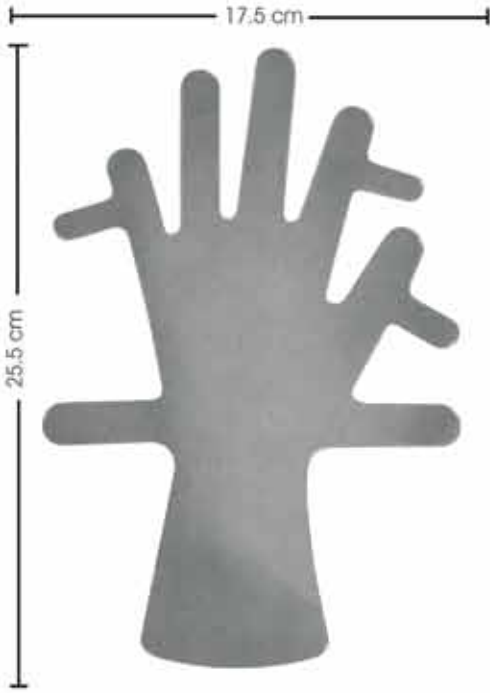

ET750-00

Çocuklar için el sabitleyici, yumuşak
Children's hand control, soft

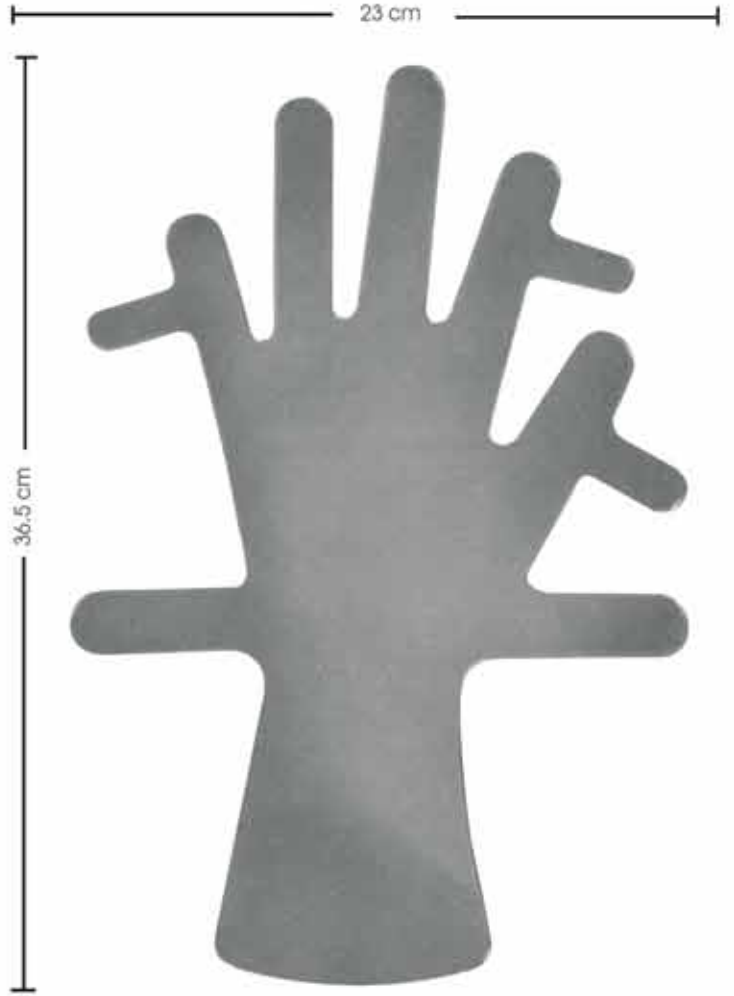

ET750-01

Yetişkinler için el sabitleyici, yumuşak
Used stabilizer for adults, soft



EP685-00

Tırnak çıkarma pens
Nail splitting forceps
13 cm



EP686-00

Tırnak çıkarma pens
Nail extracting forceps
13.5 cm



EP670-00

Parmak yüzük testere
Finger ring saw
15 cm

EP670-01
Yedek bleyd
Spare blade



1/2
**JOSEPH
EV765-00**
El testere
Hand saw
17 cm



1/2
**LINDEMANN
EV766-00**
El testere
Hand saw
20 cm



1/2
**SYSTRUNK
EC660-00**
Parmak tırnak kesme makası
Scissors for splitting finger nails
13 cm

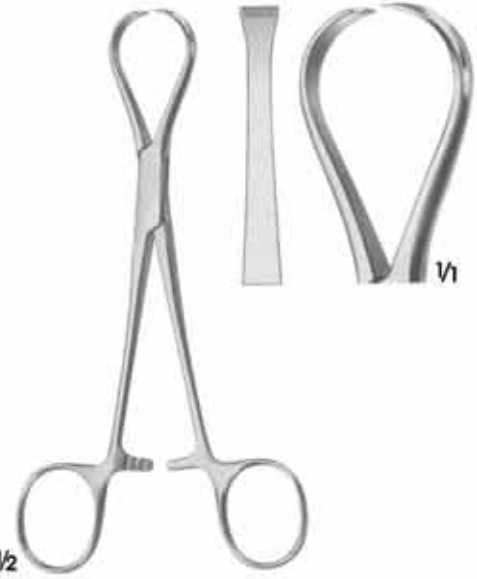

**JACKSON
EE300-00**
Tendon tutucu pens
Tendon seizing forcep
4 x 5 diş/4 x 5 teeth
15 cm



**HERZ
EE302-00**
Tendon tutucu pens
Tendon seizing forcep
15.5 cm



EE311-00
Tendon geçmeli pens
Tendon interlacing forcep
15 cm

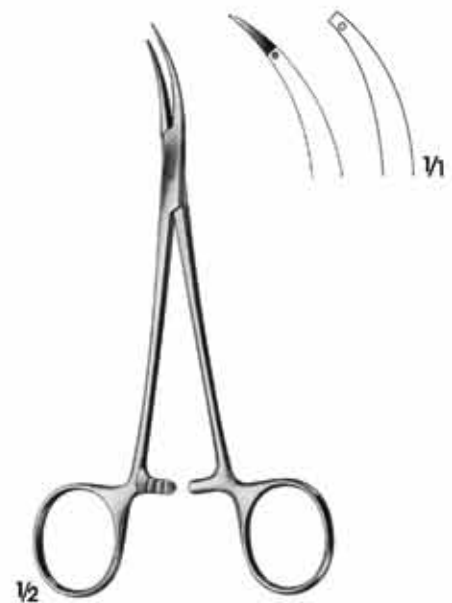

EE312-00
Tendon geçmeli pens
Tendon interlacing forcep
15 cm



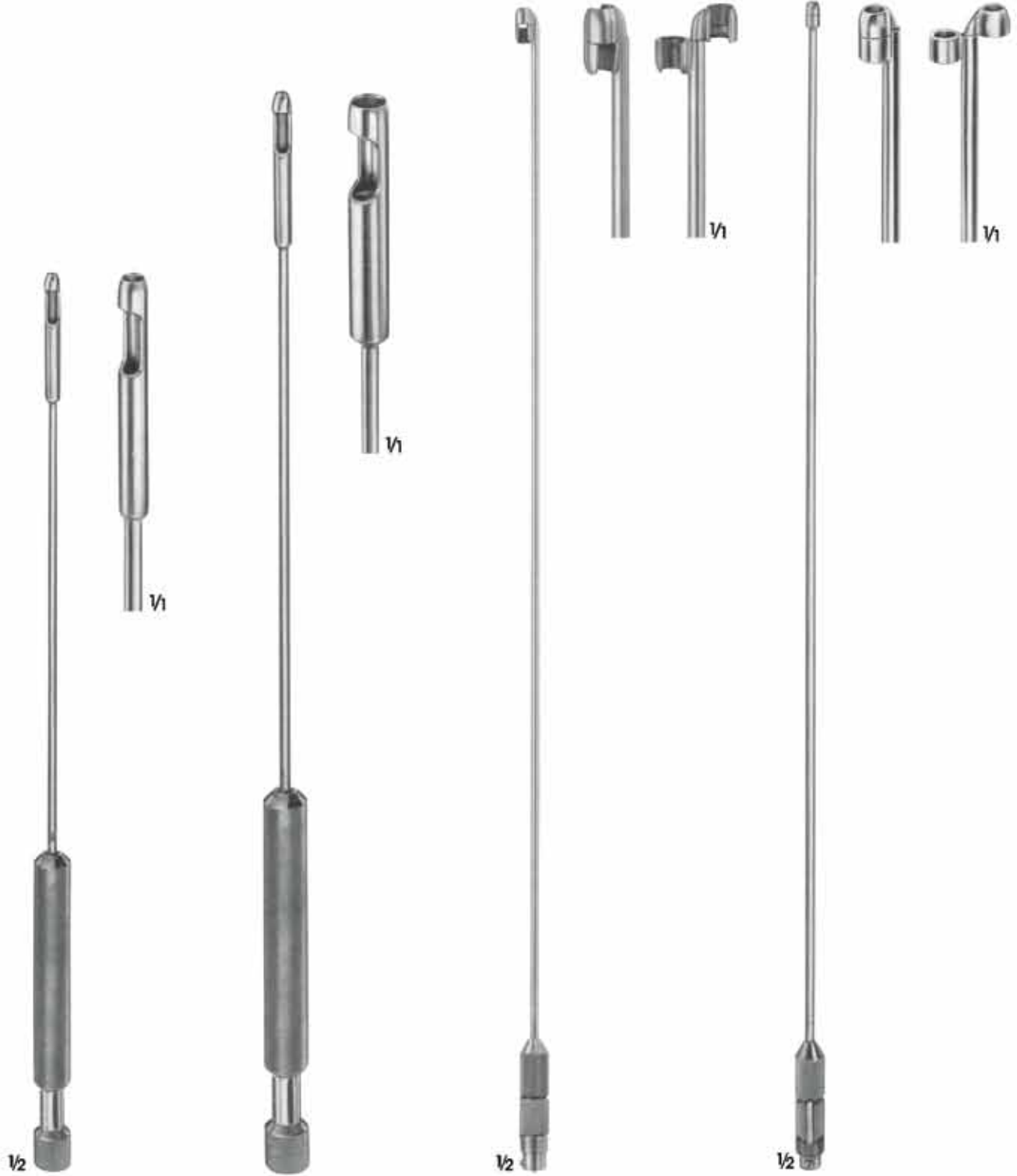

ET089-01 Ø 3 mm
Tendon stripper
Tendon stripper
Şaft uzunluğu
Schafllänge 19 cm
Toplam boy
Shaft length 30 cm

ET089-03 Ø 5 mm
Tendon stripper
Tendon stripper
Şaft uzunluğu
Schafllänge 39 cm
Toplam boy
Shaft length 49.5 cm

RELL
ET088-00 Ø 4 mm
ET088-01 Ø 6 mm
Tendon stripper
Tendon stripper
Şaft uzunluğu
Schafllänge 35 cm
Toplam boy
Shaft length 39.5 cm

ASSMUS
ET086-00 Ø 3 mm
Sinir stripper, Künt
Nerve stripper, blunt
Şaft uzunluğu
Schafllänge 35 cm
Toplam boy
Shaft length 39.5 cm

EJ035-00 Ø 2.5 mm
EJ035-01 Ø 2.5 mm
EJ035-02 Ø 3.0 mm



EJ035-00 14.5 cm
EJ035-01 16 cm
EJ035-02 20 cm
Gözlü problemler
Probes with eye



BUNNELL
EJ034-00
23 cm



BUNNELL
ET760-00 Ø 2 mm
ET760-01 Ø 3 mm
ET760-02 Ø 4 mm
ET760-03 Ø 6 mm
13.5 cm

C
ET760-00

C
ET760-01

C
ET760-02

C 1/1
ET760-03



ET763-00 Ø 3 mm
ET763-01 Ø 5 mm
30 cm



1/1
ET763-02

1/1
ET763-00



ET764-03 Ø 5 mm
50 cm

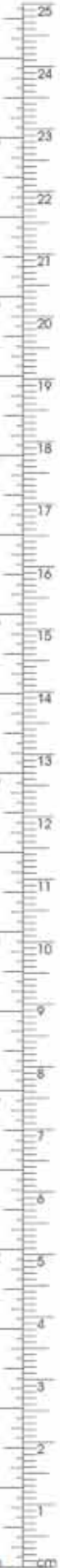

EAN

EAN

Anatomi, Amputasyon ve Otopsi Aletleri
Instruments For Anatomy, Amputation and Post Mortem



Çift taraflı kesici
Double cutting

Çift taraflı kesici
Double cutting



LANGENBECK
EB160-00-EB161-00
Rezeksiyon bıçakları
Resection knives
Ağız uzunlukları
Length of blade
5.5 cm

EB163-00
Periyost bıçak
Periosteum knife
Ağız uzunluğu
Length of blade
6.5 cm



EB141-00
İnterosseöz bıçak
Interosseous knife
Ağız uzunluğu
Length of blade
11 cm



EB144-00
Falaniks bıçak
Phalangeal knife
Ağız uzunluğu
Length of blade
10.5 cm



LANGENBECK
EB143-00
Kanal bıçak
Flap knife
Ağız uzunluğu
Length of blade
12 cm



LISTON
EB146-00 13 cm
EB146-01 16 cm
EB146-02 19 cm
EB146-03 22 cm
Amputasyon bıçak
Amputation knives

Çift taraflı kesici
Double cutting



1/2

CATLIN
EB145-00
Ampütasyon bıçak
Amputation knife
Ağız uzunluğu
Length of blade
16 cm



1/2

EB108-00
Ağız uzunluğu
Length of blade
13 cm



1/2

EB165-00
Ağaç sap/Wooden handle
Ağız uzunluğu/Length of blade
17 cm



1/2

EB156-00
Ağız uzunluğu
Length of blade
19.5 cm



ET886-00
Kan kaşığı/Blood scoop
Hacmi 50 cc/Volume 50 cc



Ø 90 mm

ET885-00
Kan kaşığı
Blood scoops
Hacmi/Volume 50 cc





GIGLI
ET536-00 30 cm
ET536-01 40 cm
ET536-02 50 cm
İki sargılı/Two windings



GIGLI
ET537-00 30 cm
ET537-01 40 cm
ET537-02 50 cm
Üç sargılı/Three winding



GIGLI
ET530-00
Sap/Handle



DE MARTEL
ET540-00 35 cm
Kondüktör için gigli testere teli, esnek
Gigli saw for the flexible conductor wire

1/2

LEBSCHE
ET255-01
Tel testeresi için klavuz
Conductor for wire saws
Bükülebilir/Malleable
25 cm



1/2

LANGENBECK
ET600-00
Metakarpal testeresi
Metacarpal saw
Ağız uzunluğu
Length of blade
11.5 cm
23.5 cm



1/2

ET602-05
Bileyd uzunluğu
Length of blade
20 cm

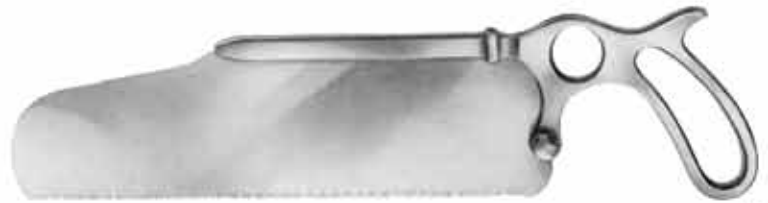

SATTERLEE
ET602-00
29 cm

1/3

ET603-05 18 cm
ET603-06 24 cm
Ağız uzunluğu
Length of blade

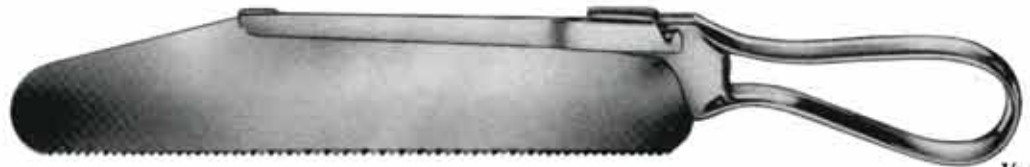

CHARRIERE
ET603-00 27 cm
ET603-02 34 cm

1/2

ET608-10 Komple/Complete
ET608-00 ET608-05 ET608-07

CHARRIERE

ET608-00

Sadece sap/Only handle
35 cm

ET608-05 12 mm

ET608-07 18 mm

Bleyd uzunluğu
Length of blade
21.5 cm



ET609-12 Komple/Complete
ET609-00 ET609-05 ET609-06

(1 adet/1 each)

ET609-07(2 adet/2 each)

RUST

ET609-00

Sadece sap/Only handle
39 cm

ET609-05 6 mm

ET609-06 8 mm

ET609-07 12 mm

ET609-08 18 mm

Bleyd uzunluğu
Length blade
23.5 cm

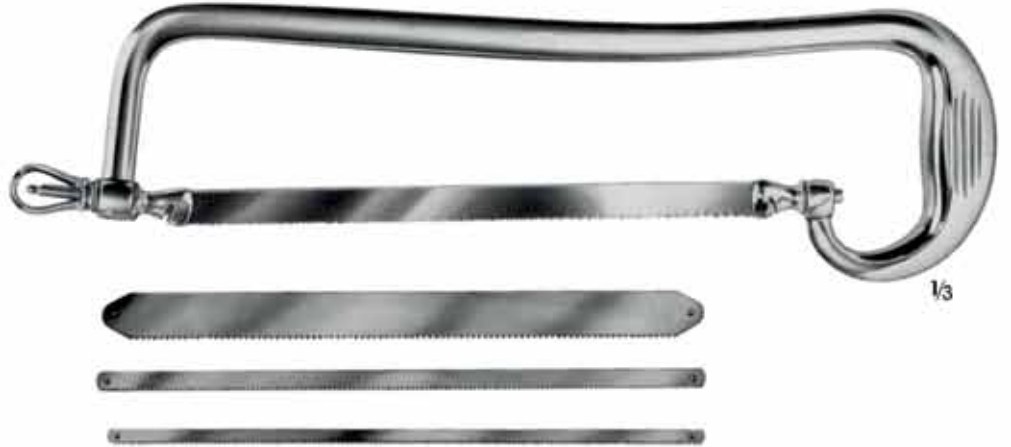

BIER

ET607-10 Komple/Complete
ET607-00 ET607-03 ET607-04
ET607-06

ET607-00

Sadece sap/only handle
42 cm

ET607-03 4 mm

ET607-04 6 mm

ET607-06 8 mm

Bleyd uzunluğu
Length blade
27 cm



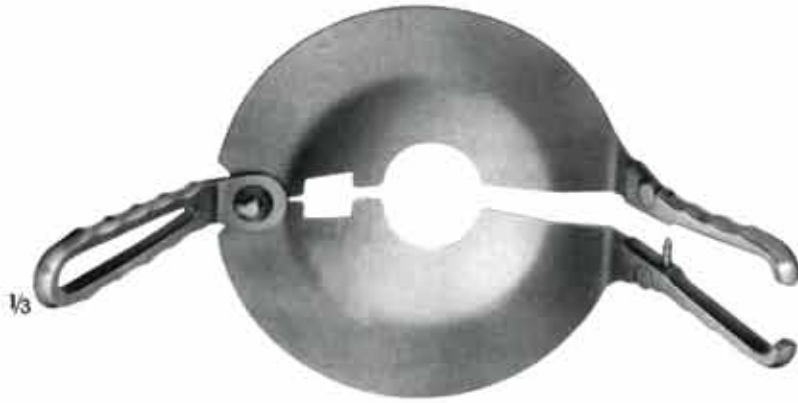

PERCY
ET890-00
Sökülebilir saplı
Removable handles

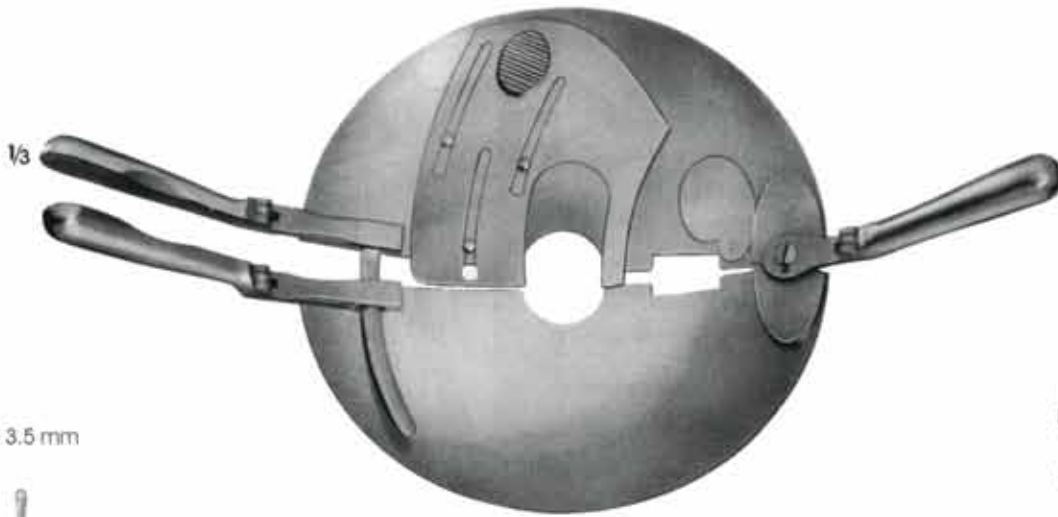

PERCY
ET891-00
Ters çevrilebilir saplı
Reversible handles

Ø 3.5 mm



EJ038-01 30 cm
Çift başlı sonda bükülebilir, delikli
Double ended probes, malleable, with hole



ED240-03 16 cm
ED240-04 18 cm
ED240-05 20 cm

ED240-03-ED240-05
Standart model/Standard pattern
Diseksiyon penseti/Dissecting forceps



ED360-04 16 cm
ED360-05 18 cm
ED360-06 20 cm

STANDARD
ED360-04-ED360-06
Standart model
Standard pattern

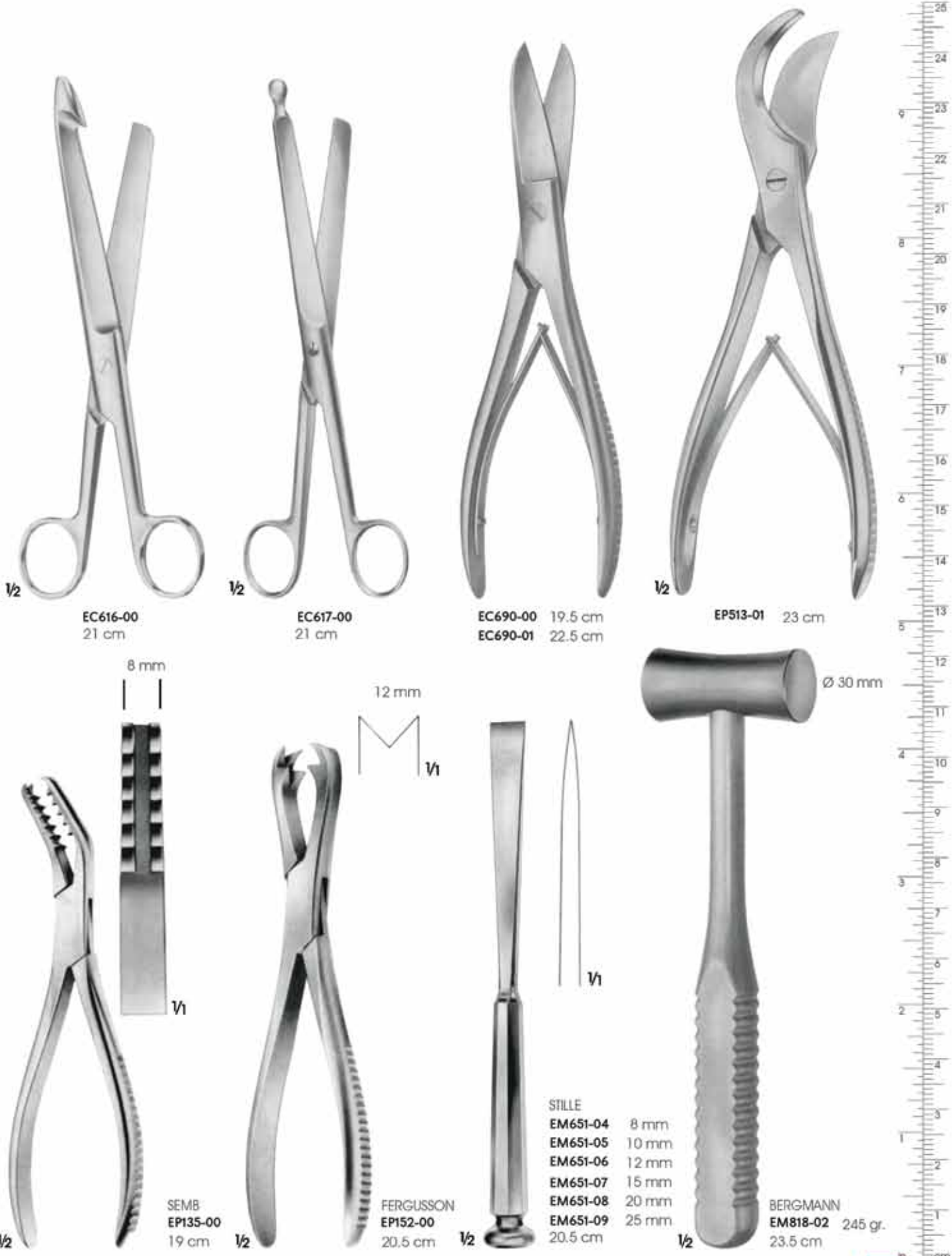

1/2
EC616-00
21 cm

1/2
EC617-00
21 cm

EC690-00 19.5 cm
EC690-01 22.5 cm

1/2
EP513-01 23 cm

8 mm
1/2
SEMB
EP135-00
19 cm

12 mm
1/2
FERGUSON
EP152-00
20.5 cm

1/2
STILLE
EM651-04 8 mm
EM651-05 10 mm
EM651-06 12 mm
EM651-07 15 mm
EM651-08 20 mm
EM651-09 25 mm
20.5 cm

Ø 30 mm
1/2
BERGMANN
EM818-02 245 gr.
23.5 cm



EDE

Dermatoloji
Dermatology



- EB200-01 Ø 2 mm
- EB200-02 Ø 3 mm
- EB200-6 Ø 4 mm
- EB200-04 Ø 6 mm
- EB200-06 Ø 7 mm

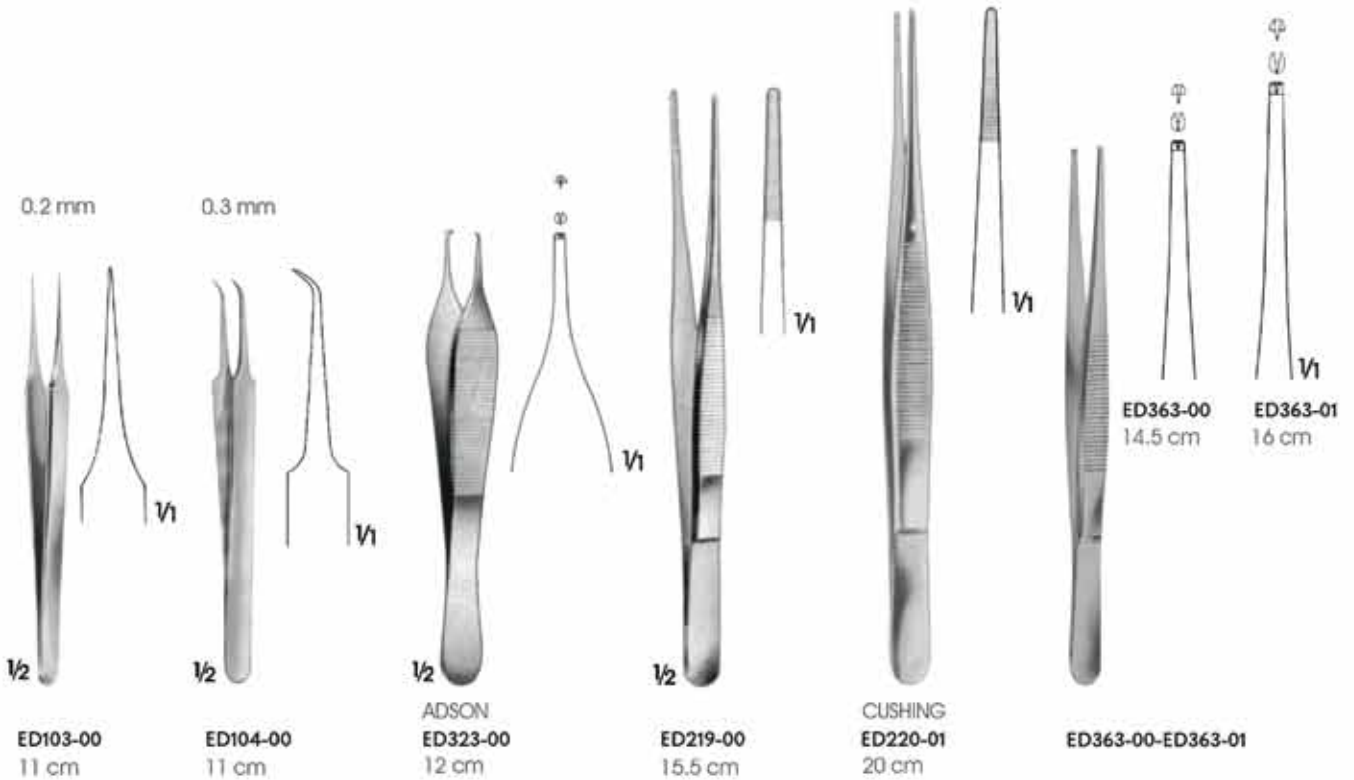

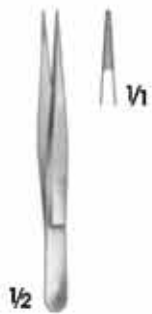

ED410-00
8 cm

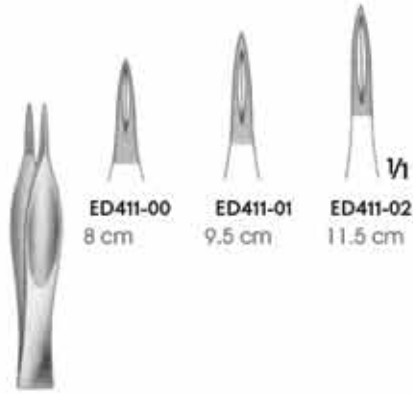

FEILCHENFELD
ED411-00-ED411-02



HUNTER
ED412-00
10.5 cm

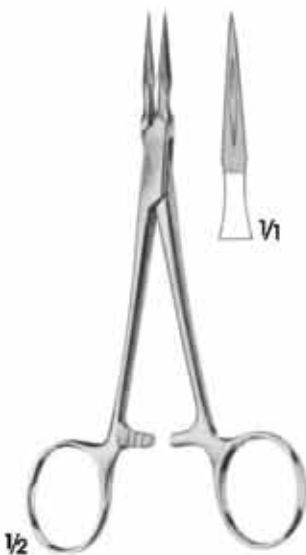

STIEGLITZ
ED420-00
14 cm



STIEGLITZ
ED421-00
14 cm

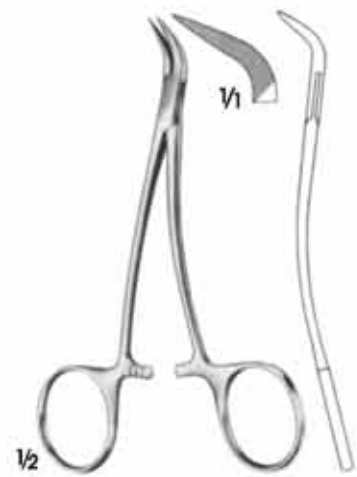

PEET
ED422-00
12 cm



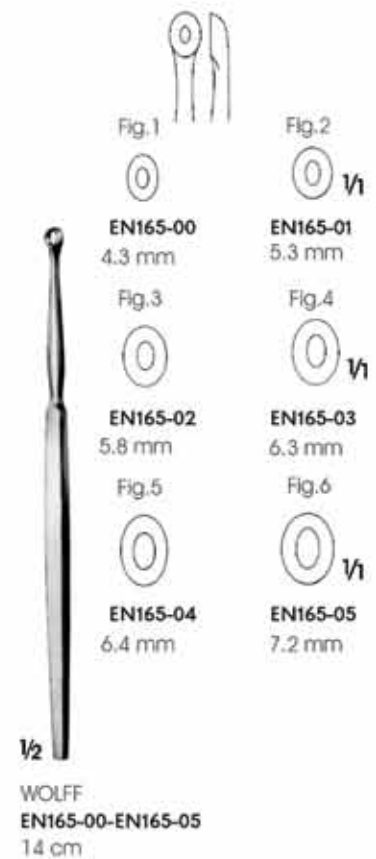



1/2

SILVER
EB186-00P

Cilt nakli bıçağı, bıçaksız
Skin graft knife, without blade
19 cm



1/2

SCHINK
EB182-00

Sadece dermatom
Dermatome only
30 cm

SCHINK
EB182-01

Dermatom 0.1mm 'den 2.0mm kadar ayarlanabilir, 1 adet değiştirilebilir, B 188.01 ve 2 adet B 188.00 deri düzeltme plakası ile birlikte komple
Dermatome, adjustable from 0.1mm to 2.0 mm, complete, with 1 interchangeable blade and 2 skin straightening plates
30 cm

EB188-01

Yedek Bıçak
Spare blade only



EB188-00

Cilt düzeltme plağı
Skin straightening plate only



Sabit bar
Bar fixed



1/2

WATSON
EB184-00

Cilt nakli bıçağı, bıçaksız
Skin graft knife, without blade
30 cm



EMR

Mikroskopi
Microscopy



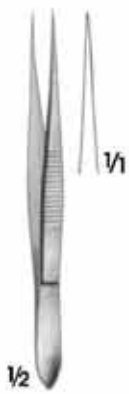

ED250-00
10 cm



ED251-00
10 cm



ED252-00
10 cm

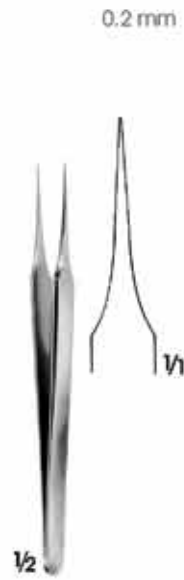

ED103-00
11 cm

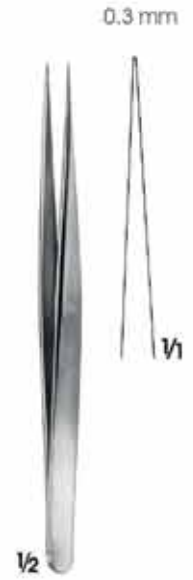

ED108-00
13.5 cm

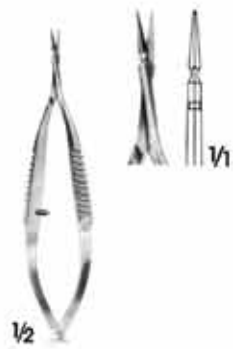

VANNAS
EC070-00
Düz/Straight
Hassas/Delicate
8.5 cm



EC102-00
Düz/Straight



EC103-00
Eğri/Curved

EC102-00-EC103-00
Mikro makaslar
Micro scissors
12 cm



REILL
EF126-00-EF127-00
Kılıtsız/Without catch
15 cm



EB228-00

Metal saplı,
mikroskopik iğne
Microscopic needle, with
metal handle
13 cm

EB229-00

Metal saplı,
mikroskopik iğne
Microscopic needle with
metal handle
13 cm



**MULLER
EL004-00**

Fare için ekartör bir çift
Retractors for mouse
paws



**FINSEN
EL082-00**
7.5 cm



**WEITLANER
EL300-00** Sivri/Sharp
11 cm



ES030-00
Approximater/Approximater

Derin aralıkta mikro damar anastomileri için.
Güvenli ve dikkatli şekilde damar kavrama.
Tırtıklı yüzeyli bleydler.
El ile basınç ayarı yapabilmeye özelliği.
Mesafeyi el ile yakınlaştırma ve uzaklaştırma.

For micro vessel anastomosis
Safe and careful gripping of vessel.
Blades with serrated blade surface
The ability to manually set the pressure
Distance, zoom in and out manually



**BIEMER
ES026-00**
Komple Aproksimater,
anahtar ile S 029.00
Approximater, complete
with key S 029.00



**BIEMER
ES025-00**
Komple Aproksimater,
anahtar ile ES029-00
Approximater, complete
with key ES029-00

ES029-00
Anahtar/Key



**BIEMER-MÜLLER
ES014-00**
Çene uzunluğu/Lenght of jaws.9 mm
Açıklık/Opening 5 mm
Kapanma kuvveti/Closing force 25-30 gr.



**BIEMER
ES035-00**
Kilitli/With Lock
BIEMER damar klip ve BIEMER-MÜLLER
ve MÜLLER yaklaşırtıcılar için başvuru pensli
Applying forcep for BIEMER vessel clip and
BIEMER-MÜLLER and MÜLLER approximators
14 cm

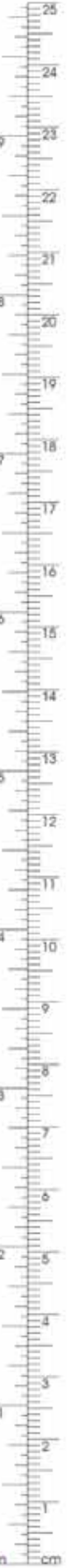

EEC

Elektrocerrahi Aletleri
Electrosurgical Instruments





EZ121-00
12 cm



EZ120-00
11 cm



EZ100-00
14.5 cm



EZ130-00
Sivri/Sharp
12.5 cm



EZ130-02
Hassas/Delicate
17.5 cm



EZ130-04
Hassas/Delicate
22 cm

Yapışmaz/Non sticking

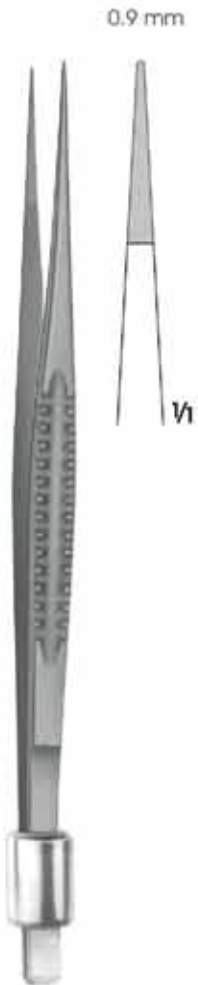

EZ173-02
Düz/Straight
İzoleli/Insulated
16 cm



EZ173-04
Düz/Straight
İzoleli/Insulated
18.5 cm



EZ173-06
Düz/Straight
İzoleli/Insulated
20 cm



EZ171-01
Açılı/Angled
İzoleli/Insulated
16 cm



EZ172-01
Açılı/Angled
İzoleli/Insulated
20 cm



İzoleli
Insulated



EZ150-00 0.6 mm
EZ150-01 0.9 mm
16 cm
EZ150-03 0.9 mm
20 cm

İzoleli
Insulated



EZ150-03 0.9 mm
20 cm
EZ151-01 0.9 mm
16 cm

İzoleli
Insulated



EZ160-00 0.4 mm	EZ160-08 0.4 mm	EZ160-16 0.4 mm	EZ160-26 0.7 mm
EZ160-01 0.7 mm	EZ160-09 0.7 mm	EZ160-17 0.7 mm	25.5 cm
EZ160-02 1.0 mm	EZ160-10 1.0 mm	EZ160-18 1.0 mm	
EZ160-03 1.3 mm	EZ160-11 1.3 mm	EZ160-19 1.3 mm	
14 cm	17.5 cm	21.5 cm	
EZ160-04 0.4 mm	EZ160-12 0.4 mm	EZ160-20 0.4 mm	
EZ160-05 0.7 mm	EZ160-13 0.7 mm	EZ160-21 0.7 mm	
EZ160-06 1.0 mm	EZ160-14 1.0 mm	EZ160-22 1.0 mm	
EZ160-07 1.3 mm	EZ160-15 1.3 mm	EZ160-23 1.3 mm	
15.5 cm	19.5 cm	23.5 cm	



Özellikler

- Doku hazırlanması ve ayırması için uygun.
- Yuvarlak çalışma uçları.
- Dayanıklı izolasyon kaplaması.
- Güvenilir fişli bağlantı.

Features

- Suitable for tissue preparation and spreading.
- Rounded working tips.
- Durable insulation coating.
- Reliable plug-in connection.

İzoleli
Insulated



Özellikler

- İnce, hassas, yuvarlak, parlak çalışma
- Dayanıklı izolasyon kaplaması.
- Güvenilir fişli bağlantı.

Features

- Slim, delicate, rounded, polished working tips.
- Durable insulation coating.
- Reliable plug-in connection.

EZ200-00	0.2 mm	EZ200-08	0.2 mm
EZ200-01	0.5 mm	EZ200-09	0.5 mm
EZ200-02	1.0 mm	EZ200-10	1.0 mm
EZ200-03	2.0 mm	EZ200-11	2.0 mm
	16.5 cm		22 cm
EZ200-04	0.2 mm		
EZ200-05	0.5 mm		
EZ200-06	1.0 mm		
EZ200-07	2.0 mm		
	19.5 cm		

İzoleli
Insulated



EZ202-00	1.0 mm
	16.5 cm
EZ202-02	1.0 mm
	19.5 cm
EZ202-04	1.0 mm
	22 cm

İzoleli
Insulated



- Halka uçlar
- Dayanıklı izolasyon kaplaması.
- Güvenilir fişli bağlantı.
- Ring tips
- Durable insulation coating.
- Reliable plug-in connection.

EZ213-00	2/3 mm	EZ215-00	2/3 mm
EZ213-01	3/4 mm	EZ215-01	3/4 mm
EZ213-02	4/5 mm	EZ215-02	4/5 mm
	19.5 cm		23.5 cm

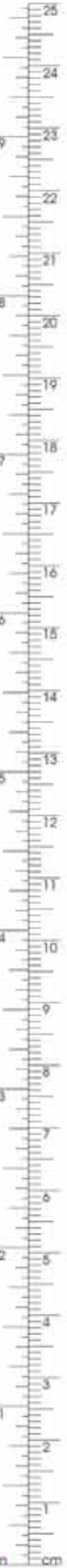

Yapışmaz/Non sticking



EZ180-00 0.7 mm
16 cm
EZ180-01 1.0 mm
18.5 cm
EZ180-02 1.0 mm
20 cm

İzoleli
Insulated



EZ180-10 0.7 x 23 mm
16 cm
EZ180-11 1.0 x 23 mm
18.5 cm
EZ180-12 1.0 x 23 mm
20 cm

İzoleli
Insulated



EZ184-10 1.0 mm
21 cm

İzoleli
Insulated

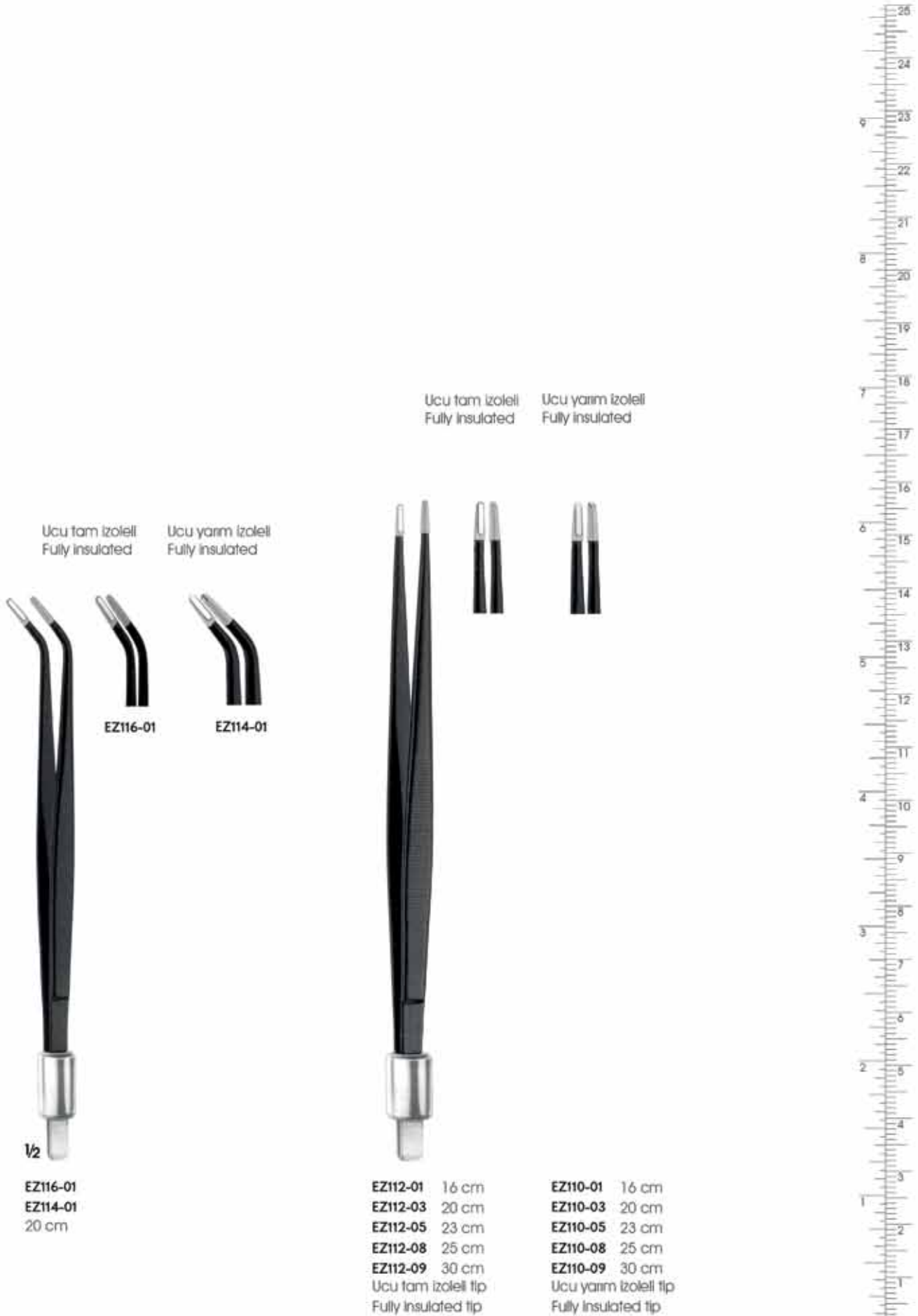

Ucu tam izoleli
Fully insulated

Ucu yarı izoleli
Fully insulated

Ucu tam izoleli
Fully insulated

Ucu yarı izoleli
Fully insulated

1/2

EZ116-01
EZ114-01
20 cm

EZ116-01

EZ114-01

EZ112-01 16 cm
EZ112-03 20 cm
EZ112-05 23 cm
EZ112-08 25 cm
EZ112-09 30 cm
Ucu tam izoleli tip
Fully insulated tip

EZ110-01 16 cm
EZ110-03 20 cm
EZ110-05 23 cm
EZ110-08 25 cm
EZ110-09 30 cm
Ucu yarı izoleli tip
Fully insulated tip

Atromatik
Atraumatic



EZ230-00 18 cm
EZ230-01 20 cm
EZ230-03 24 cm
EZ230-05 30 cm
Izoleli/Insulated



EZ231-00 18 cm
EZ231-01 20 cm
EZ231-03 24 cm
EZ231-05 30 cm
Izoleli/Insulated
1 x 2 dls/1 x 2 teeth



EZ232-01 20 cm
EZ232-03 24 cm
EZ232-05 30 cm
izoleli/insulated

Atromatik
Atreumatic



Ø 4 mm

Ø 2.4 mm



Ø 2.4 mm **EZ017-00P**
Ø 4.0 mm **EZ017-01P**
Bıçak elektrotları
Knife electrodes



Ø 2.4 mm **EZ018-00P**
Ø 4.0 mm **EZ018-01P**
Kesme elektrotlar
Cutting electrodes



Ø 2.4 mm **EZ019-00P**
Ø 4.0 mm **EZ019-01P**
Kesme elektrotlar
Cutting electrodes



Ø 2.4 mm **EZ020-00P**
Ø 4.0 mm **EZ020-01P**
Kesme elektrotlar
Cutting electrodes



Ø 2.4 mm **EZ021-00P**
Ø 4.0 mm **EZ021-01P**
İğne elektrotlar
Needle electrodes



Ø 2.4 mm **EZ022-00P**
Ø 4.0 mm **EZ022-01P**
Halkalı elektrotlar
Loop electrodes

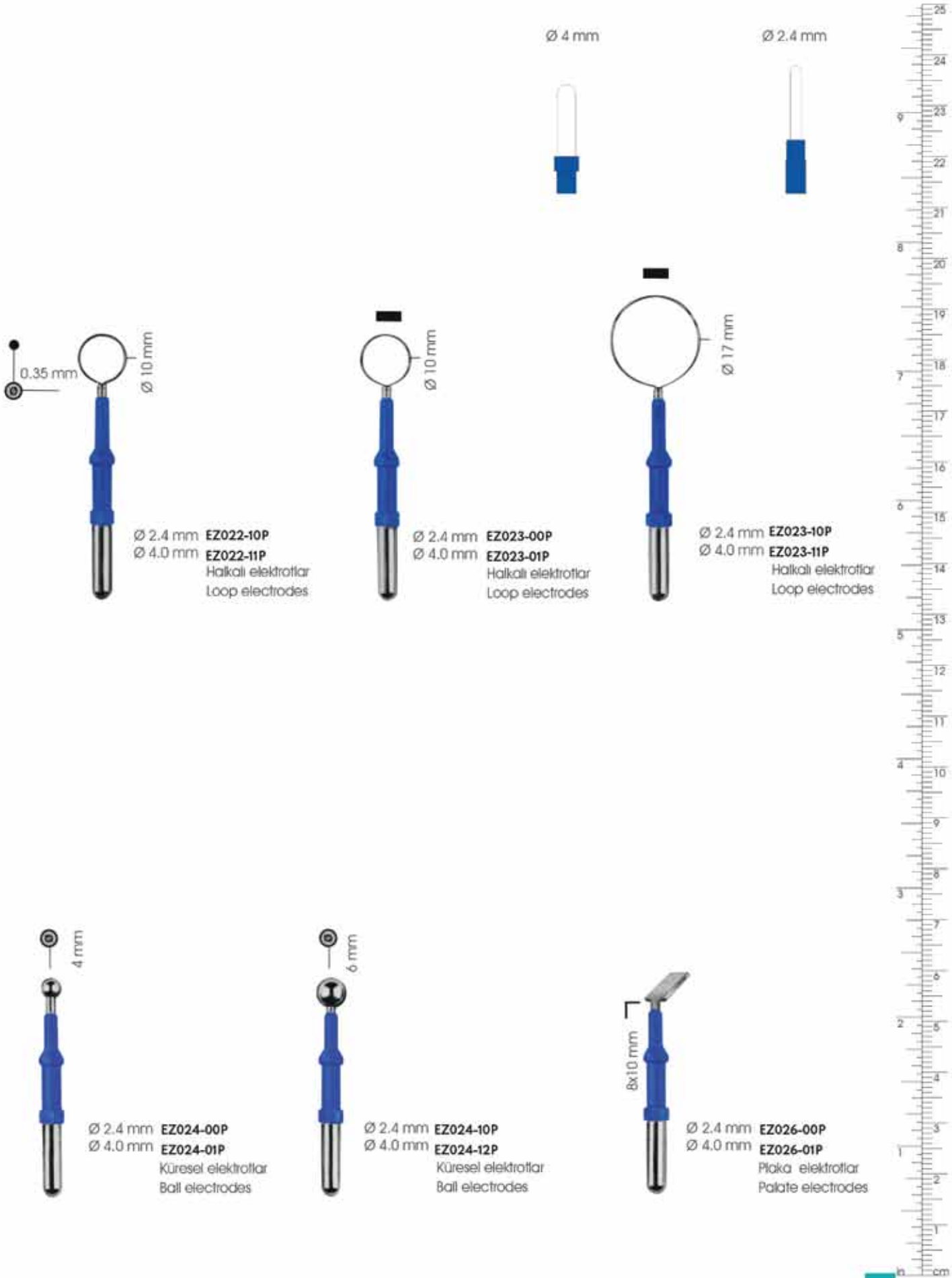

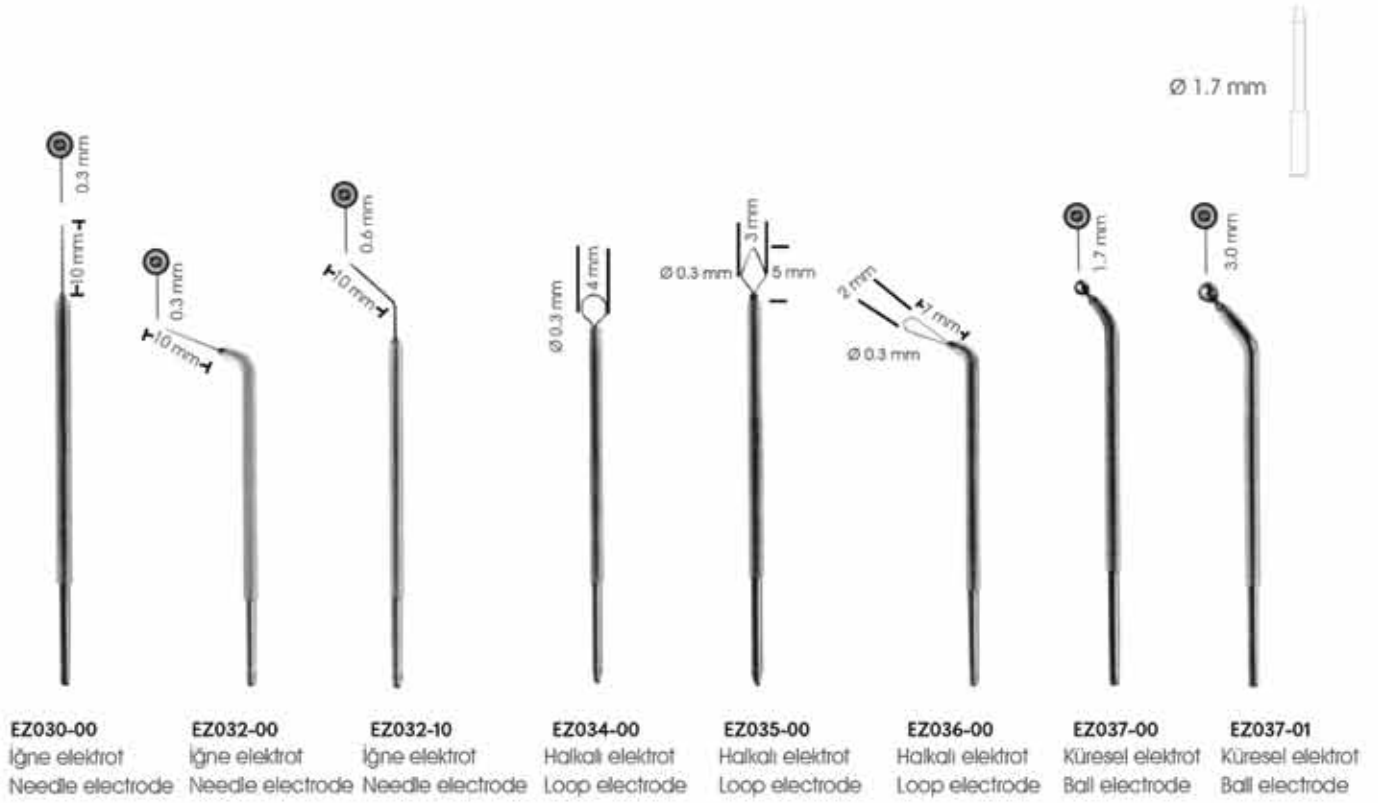

EZ097-01 Komplete/Complete
12 adet cerrahi elektrot/Surgical lead of 12
(EZ017-00P-EZ018-00P-EZ019-00P-EZ020-00P
EZ021-00P-EZ022-00P-EZ022-10P-EZ023-00P
EZ023-10P-EZ024-00P-EZ024-10P-EZ026-00P)
1 adet konteyner (EZ096-00) / 1 each container
1 adet rak (EZ098-03) / 1 adet rack

EZ097-02 Komplete/Complete
12 adet cerrahi elektrot/Surgical lead of 12
(EZ017-02P-EZ018-01P-EZ019-01P-EZ020-01P
EZ021-01P-EZ022-01P-EZ022-11P-EZ023-01P
EZ023-11P-EZ024-01P-EZ024-12P-EZ026-01P)
1 adet konteyner (EZ096-00) / 1 each container
1 adet rak (EZ098-03) / 1 adet rack



EZ096-00
Kapaklı elektrot konteyneri
Container with lid for electrodes



EZ098-03
Elektrotlar için rak / "Rack for
electrodes



EZ001-00
Oval kesme elektrodu
Cutting electrode
Boy/Length 30 mm
En/Wide 3.5 mm



EZ002-00
Açılı kesme elektrodu
Angled cutting electrode
Boy/Length 14 mm
En/Wide 1.8 mm



EZ003-00
Kesme elektrodu, hassas
Cutting electrode, delicate
25 mm



EZ004-00
Bıçak elektrod
Knife electrode
25 mm



EZ005-00
Bıçak elektrod
Knife electrode
18 mm



EZ010-00
Plaka elektrod
Plate electrode



EZ006-00
Halkalı elektrot
Loop electrode
Ø 10 mm
Tel Ø 3 mm/Wire Ø 3 mm



EZ009-00
Halkalı elektrot
Loop electrode
Ø 15 mm



EZ012-00
Açılı halkalı elektrot
Angled loop electrode
Ø 8 mm



EZ015-00 Ø 2.5 mm
EZ015-01 Ø 4 mm
EZ015-02 Ø 6 mm
Küresel uçlu elektrotlar
Ball point electrodes



EZ016-00 Ø 0.3 mm
EZ016-01 Ø 0.5 mm
EZ016-02 Ø 0.7 mm
İğne elektrotlar
Needle electrode
25 mm



Z 095.00 Komple/Complete
Cerrahi elektrotlar-Surgical electrodes
Ø 4 mm

12 Elektrotluk ray
Rack for 12 surgical electrodes
(Z 001.00-Z 002.00-Z 003.00-Z 004.00-Z 005.00
Z 006.00-Z 009.00-Z 010.00-Z 012.00-Z 015.00
Z 015.01-Z 016.00-Z 098.01)



Z 096.00
Kapaklı elektrot konteyneri
Container with lid for electrodes
25 cm
Z 097.00 Komple/Complete
Z 095.00 - Z 096.00



Ø 2.4 mm

Ø 4.0 mm



EZ052-01
Bıçak elektrot
Knife electrode

EZ052-03
Bıçak elektrot
Knife electrode

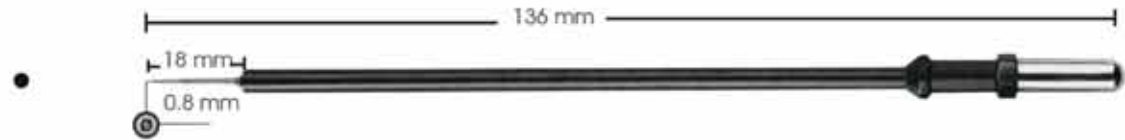

EZ051-01
İğne elektrot
Needle electrode

EZ051-03
İğne elektrot
Needle electrode

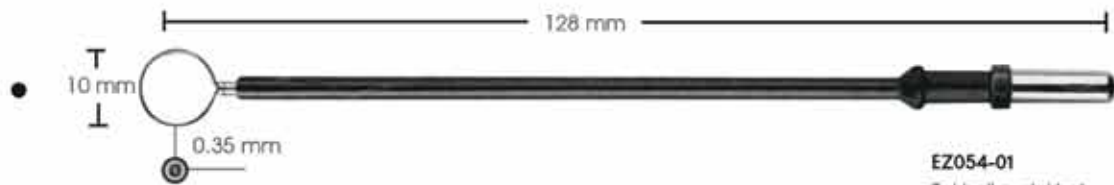

EZ054-01
Tel halka elektrot
wire loop electrode



EZ055-01
Küre elektrot
Ball electrode

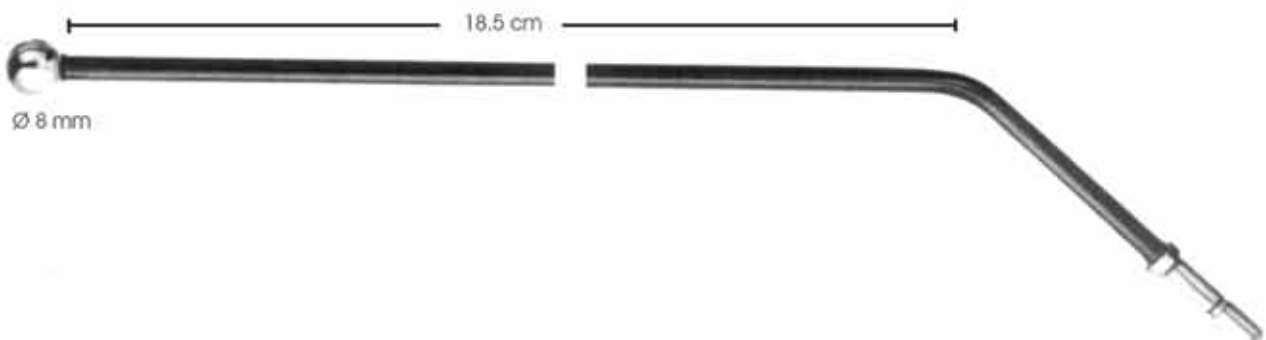

EZ046-01

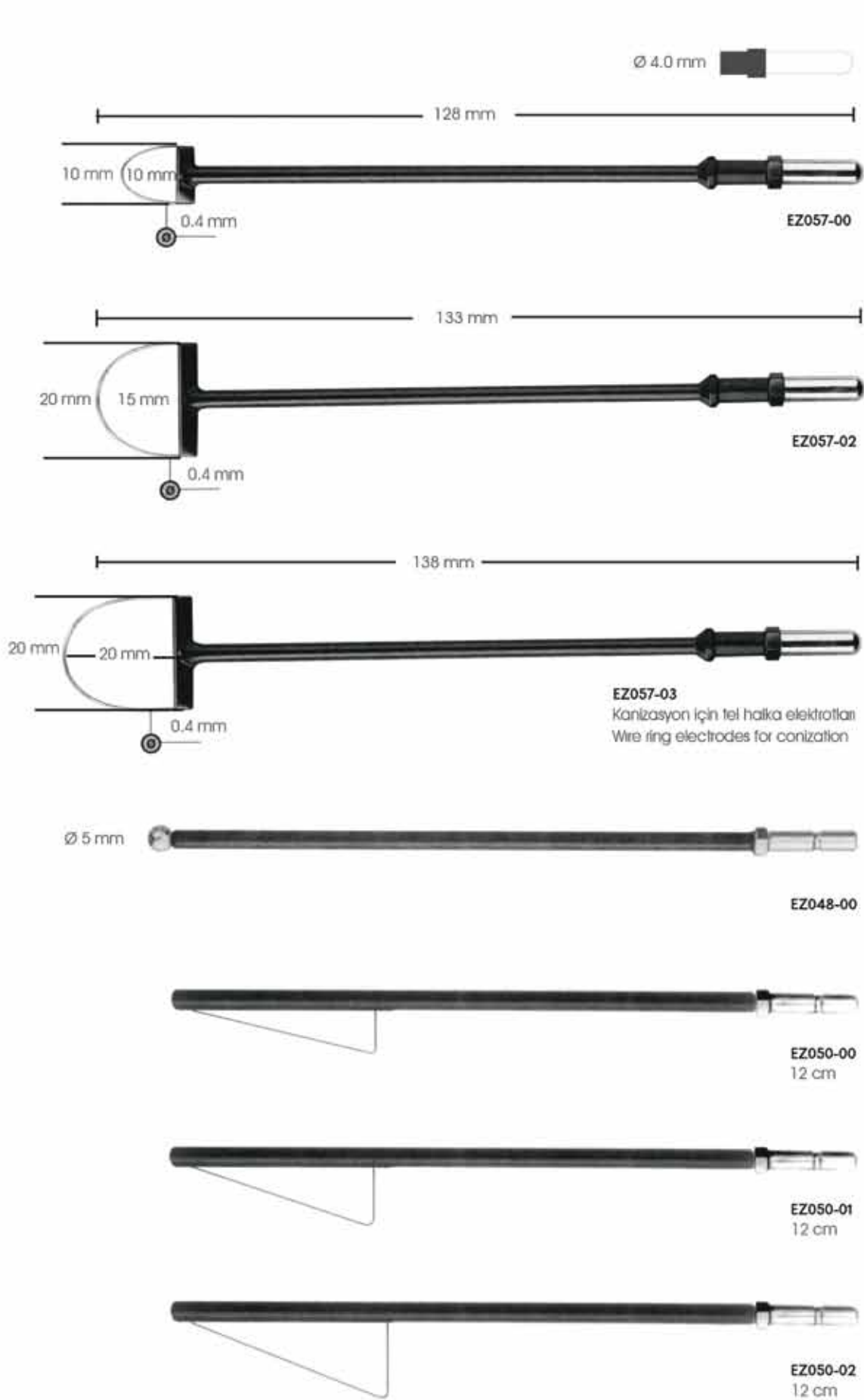

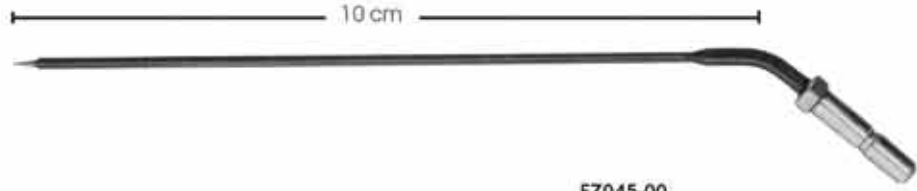

EZ045-00
Burun için iğne elektrot
Needle elektrode for nasal concha



EZ040-00
İğne elektrot
Needle elektrode



EZ041-00
Bıçak elektrot
Kniye elektrode



EZ043-00
Halkalı elektrot
Wire loop elektrode



EZ043-01
Halkalı elektrot
Wire loop elektrode



EZ044-00
Halkalı elektrot
Wire loop elektrode
10 x 10 mm



EZ044-01
Halkalı elektrot
Wire loop elektrode
15 x 15 mm



EZ044-02
Halkalı elektrot
Wire loop elektrode
20 x 20 mm



EZ060-00
Elektrot tutucusu
Electrode holder



EZ065-00
Bipolar kordon
Bipolar cord
2 mt.



EZ309-00
Ayrılabilir aletler için kablo
Instrument cable for detachable

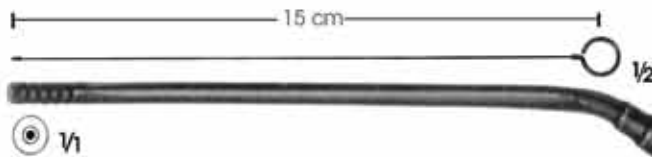

LANDOLT
EJ620-00 İzoleli/Insulated
Pihli emiş kanülü, mandrenli ve stoplu Ø 5 mm
143° buhar sterilizatörlerinde steril edilebilir.
Coagulation suction cannula
with interruptor and mandrel Ø 5 mm
Can be sterilized in a steam sterilizer up to 143°

Vakum hortumu için bağlantı
Connection for suction hose

Çap/Olive
Ø 7.5-12 mm

HF elektrotları tarafından dokunulmuş,
lekelenmemiş bağlantı Ø 4 mm
HF-Elektrot kolu Ø 4 mm
Untarnished contact to be
touched by HF-electrodes Ø 4 mm

1/2





ETS

Taslar, Böbrek Taslari
Bowls, Kidney Trays



EY901-00
0.05 LT.



EY902-00
0.1 LT.



EY903-00
0.25 LT.



EY904-00 0.02 LT.
4.0 x 2.8 x 1.9 cm
EY904-01 0.06 LT.
6.1 x 4.2 x 3.0 cm
EY904-02 0.16 LT.
8.3 x 5.4 x 4.1 cm
EY904-03 0.4 LT.
11.1 x 7.2 x 5.6 cm
EY904-04 1.0 LT.
15.1 x 10.0 x 7.3 cm
EY904-06 2.5 LT.
21.1 x 14.5 x 9.6 cm



EY901-01
Ölçü Kabi
Measuring Cup
50 mm
20 x 30 mm - 30 ml



EY900-01
175 x 100 x 35 mm
EY900-02
205 x 115 x 40 mm
EY900-03
255 x 145 x 40 mm
EY900-04
275 x 155 x 45 mm



EY905-00
1.0 LT.

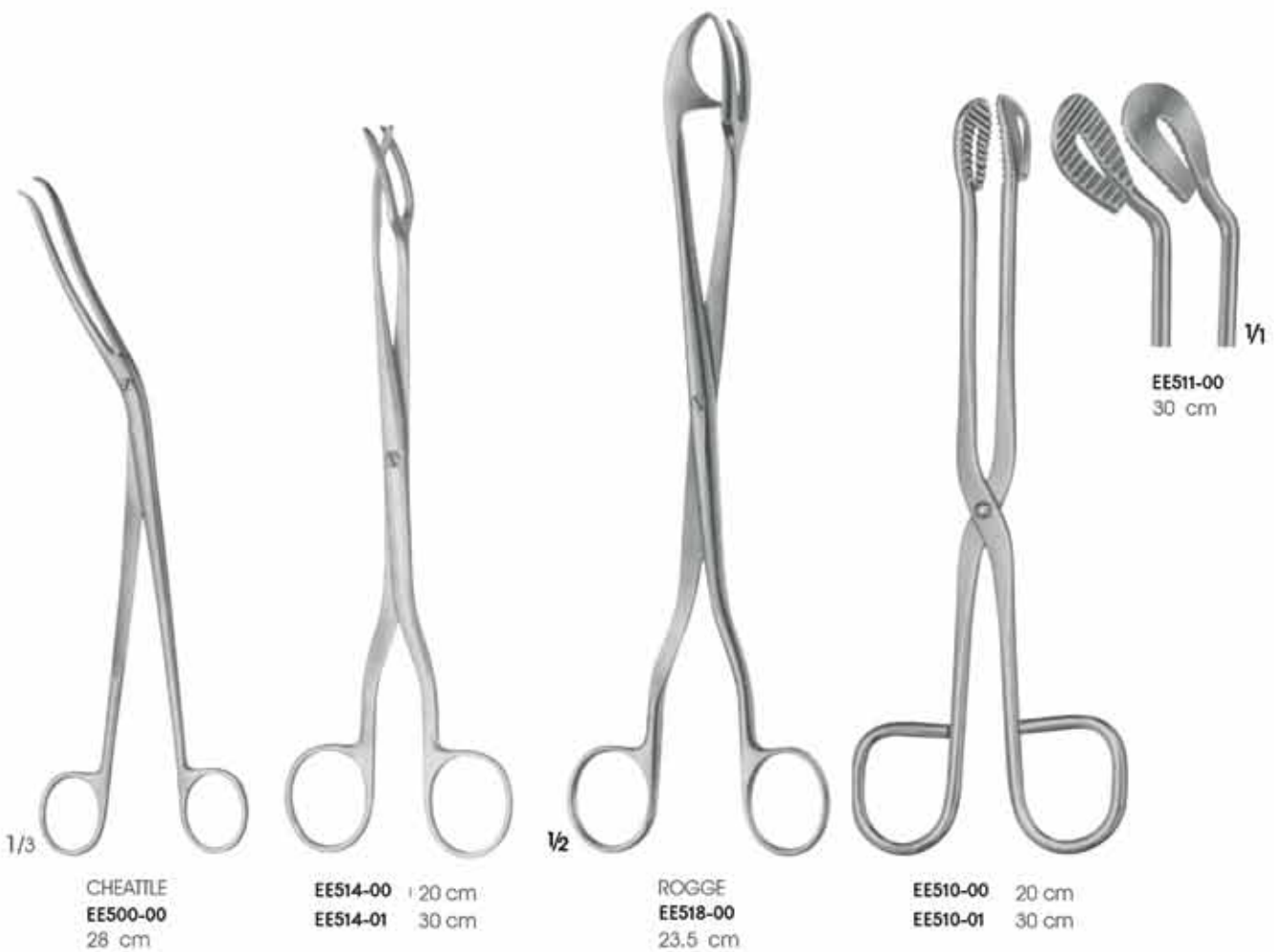



0 530 605 99 52
0 362 230 55 01

erelcerrahialetler@gmail.com
info@erelcerrahi.com
www.erelcerrahi.com

Istasyon Mh. 56'lar Sk.
N3/5 İlkadim/SAMSUN