

EJ

Sondlar, Aspiratör Uçları, Trokarlar ve Biyopsi İğneleri
Probes, Suction Tubes, Trocars and Biopsy Needles

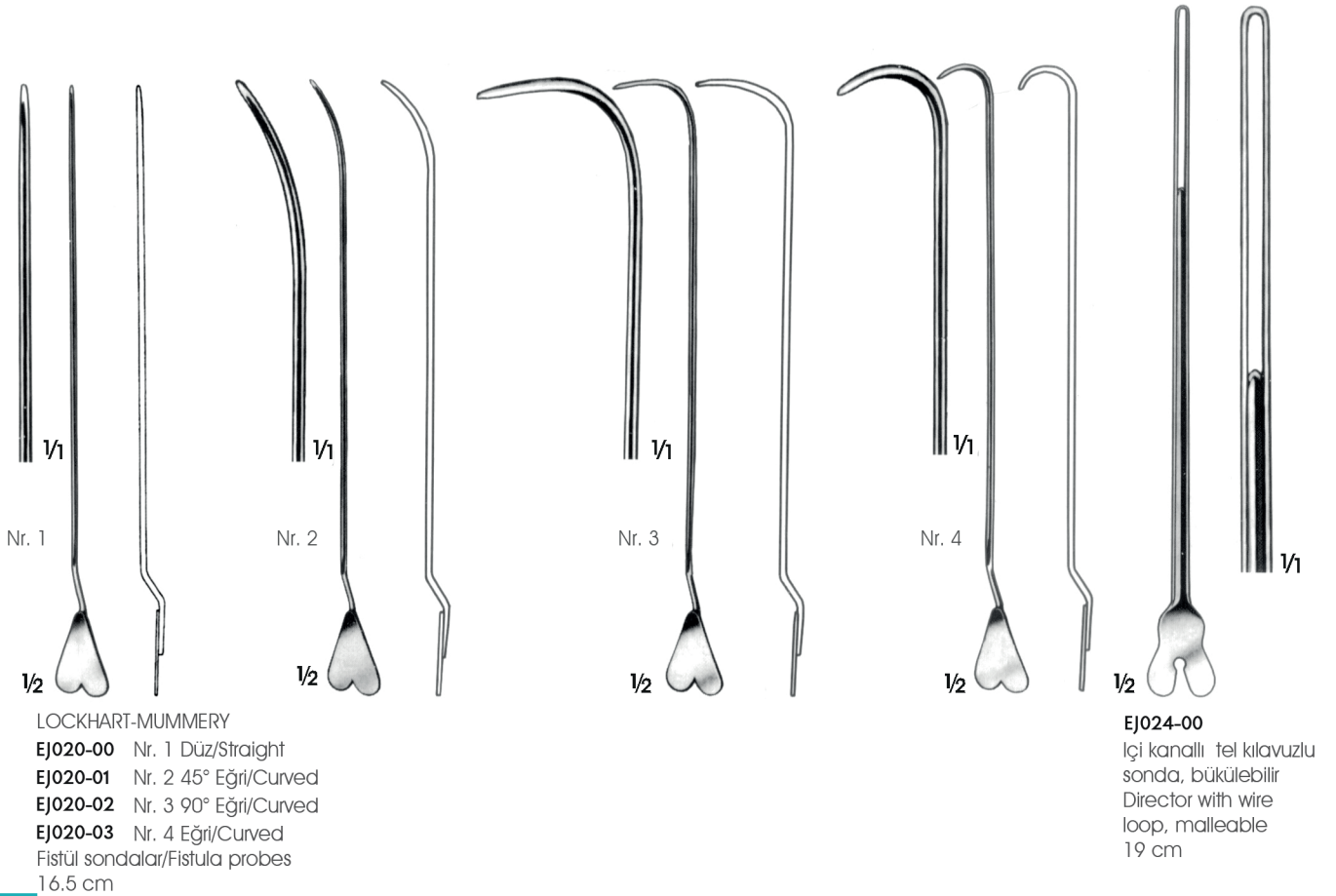

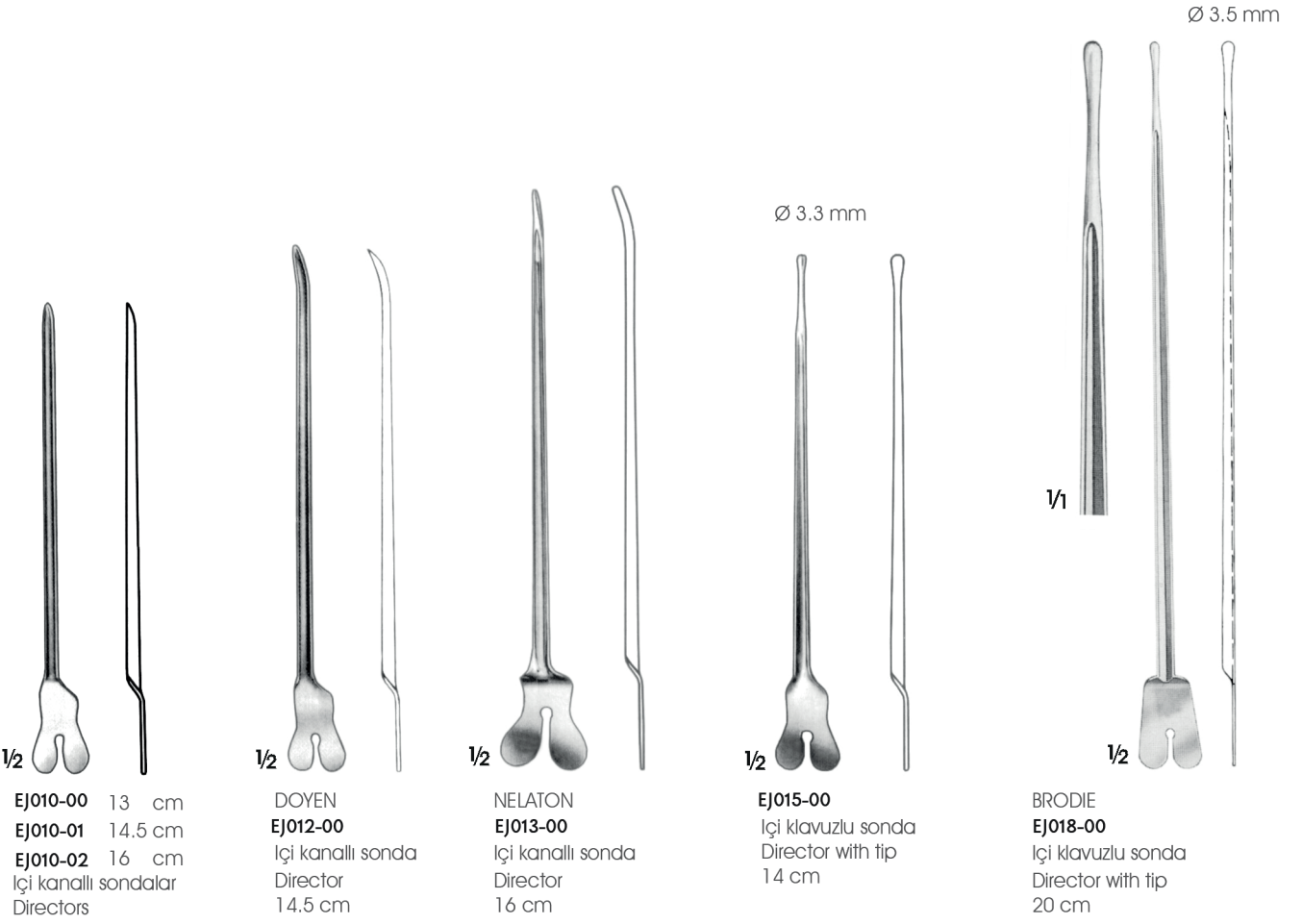

Ø 2.0 mm



EJ030-00 13 cm
EJ030-01 14,5 cm
EJ030-02 16 cm
EJ030-03 18 cm
EJ030-04 20 cm
 Mirtille yaprak sondalar
 Myrtle leaf probes

Ø 1.5 mm



EJ031-00
 Mirtille yaprak sonda
 Myrtle leaf probe
 14,5 cm



EJ035-00 Ø 2.5 mm
 14,5 cm
EJ035-01 Ø 2.5 mm
 16 cm
EJ035-02 Ø 3.0 mm
 20 cm
 Delikli sondalar
 Probes with eye

Uc çapı

Diameter of tip

1 mm

1.5 mm

2 mm

Uzunluk
Lenght

-

EJ033-07

-

13 cm

EJ033-01**EJ033-08****EJ033-15**

14,5 cm

-

EJ033-09**EJ033-16**

16 cm

-

EJ033-10**EJ033-17**

18 cm

-

EJ033-11**EJ033-18**

20 cm

-

EJ033-12

-

25 cm

-

-

EJ033-20

30 cm

EJ033-01-EJ033-20
 Sondalar/Probes

Ø 3.5 mm



EJ038-00 25 cm
EJ038-01 30 cm
 Çift başlı sondalar
 bükülebilir
 Double ended probes,
 malleable

Ø 4 mm



1/4

EJ039-00
 Çift başlı sonda bükül-
 ebilir
 Double ended probe,
 malleable
 40 cm

Ø 2.0 mm



1/3

EJ040-01
 Sonda/Probe
 30 cm

Ø 3 mm



1/2

EJ037-00
 Çift başlı sonda bükül-
 ebilir, delikli
 Double ended probe,
 malleable, with hole
 19 cm

Ø 1.2 mm



1/2

EJ039-10
 Sinus sonda
 Sinus probe
 15 cm



1/2

EJ035-05
 12,5 cm



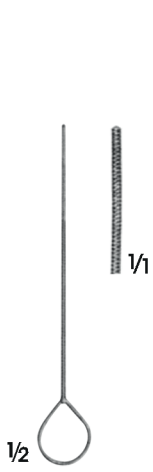

**KING'S COLLEGE HOSPITAL
EJ044-03**

Pamuk aplikatör
Cotton applicator
Sert burgulu
Rough, spiral end
9 cm

Ø 0.8 mm



**STACKE
EJ042-00**
Sonda/Probe
Gümüş/Silver
10 cm



**KING'S COLLEGE HOSPITAL
EJ044-05**

Pamuk aplikatör
Cotton applicator
Sert burgulu
Rough, spiral end
13.5 cm



**CAWTHORNE
EJ044-10**
Sonda/Probe
Yaprak uçlu, gümüş
Flattened end silver
14 cm



BOWMAN
EJ049-00 Ø 0.7 + 0.8 mm
EJ049-01 Ø 0.9 + 1.1 mm
EJ049-02 Ø 1.3 + 1.4 mm
EJ049-03 Ø 1.5 + 1.6 mm
EJ049-04 Ø 1.8 + 1.9 mm
Sondalar/Probes
Gümüş/Silver
13 cm

Ø 0.9 mm



**BUCK
EJ050-00**
Pamuk aplikatör
Cotton applicator
Ucu sert burgulu
Rough, spiral end
12 cm

Ø 1.4 mm



EJ043-00
Sonda/Probe
16 cm

Ø 1 mm



**SEIFFERT
EJ045-00**
Sonda/Probe
Gümüş/Silver
19.5 cm

Ø 1.5 mm



**KILLIAN
EJ047-00**
Sonda/Probe
16.5 cm

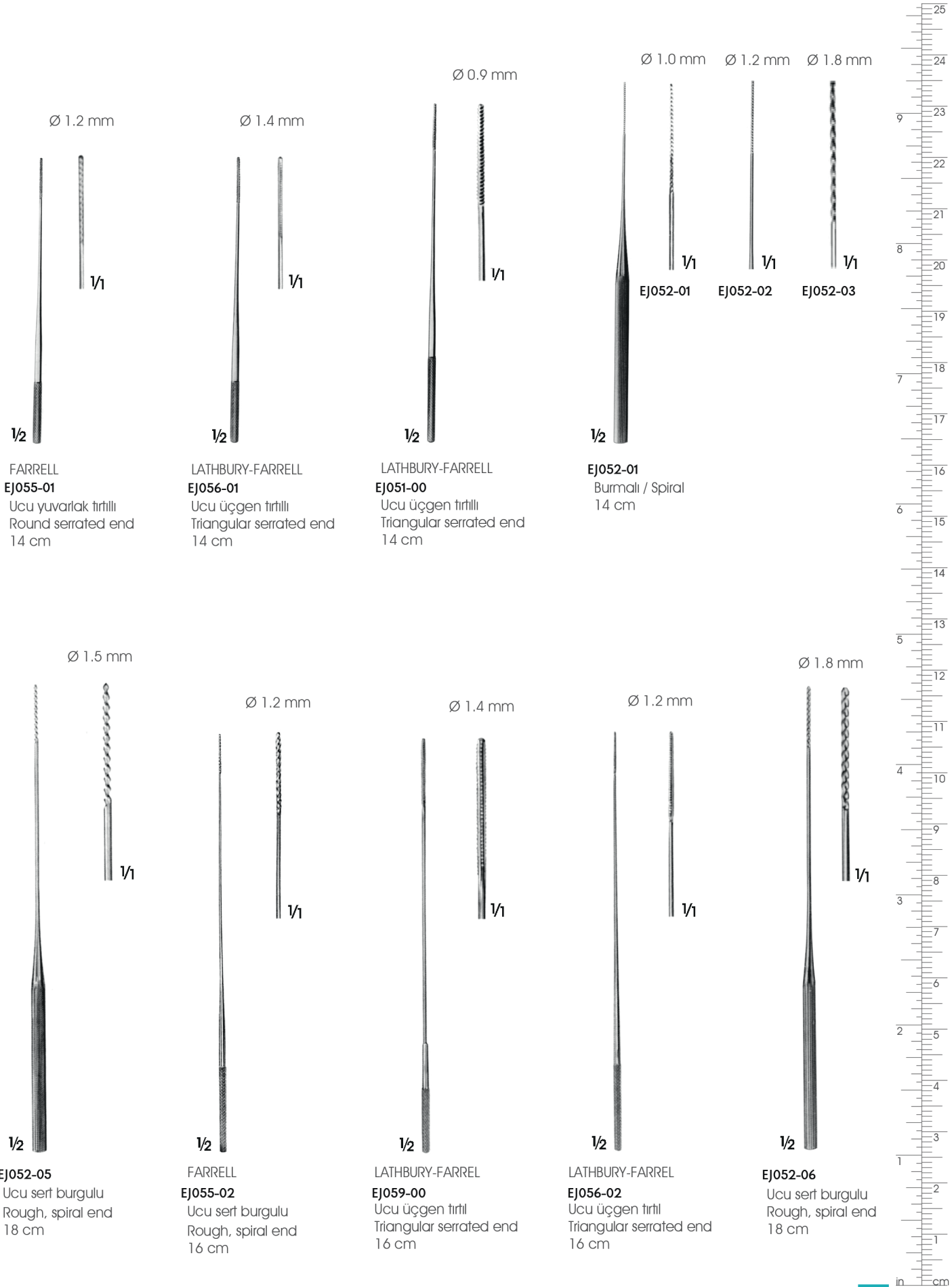

Ø 0.7 mm



PICCOLO
EJ053-00
Aplikatör/Applicator
Ucu yuvarlak tırtilli
Round serrated end
11 cm

Ø 0.7 mm



PICCOLO
EJ053-01
Aplikatör/Applicator
Ucu üçgen tırtilli
Triangular serrated end
11 cm

Ø 1.2 mm



FARRELL
EJ055-00
Aplikatör/Applicator
Ucu yuvarlak tırtilli
Round serrated end
11 cm

Ø 1.4 mm



LATHBURY-FARRELL
EJ056-00
Aplikatör/Applicator
Ucu üçgen tırtilli
Triangular serrated end
11 cm

Ø 2.3 mm

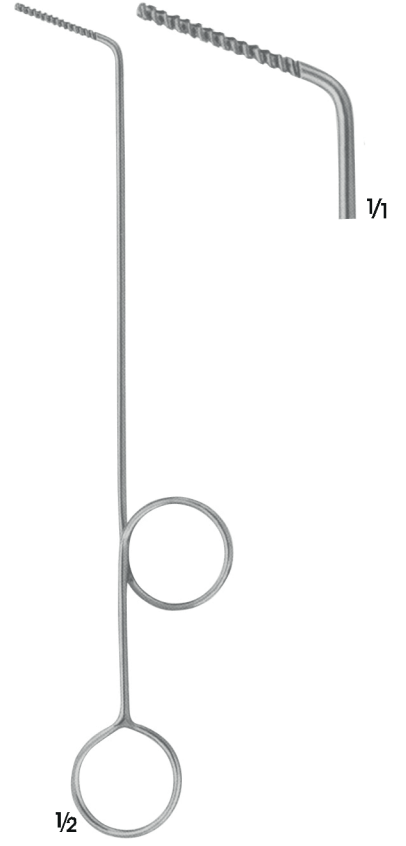

HARTMANN
EJ065-00
Aplikatör/Applicator
Sert spiral uçlu
Rough, spiral end
22 cm

16 mm



EICKEN
EJ326-00
İrigasyon kanülü, LUER bağlantılı, hafif eğri
Irrigation cannula, with LUER hub, slightly curved
14.5 cm



EICKEN
EJ326-10
İrigasyon kanülü, LUER bağlantılı, kısa eğri
Irrigation cannula, with LUER hub, shortly curved
14.5 cm

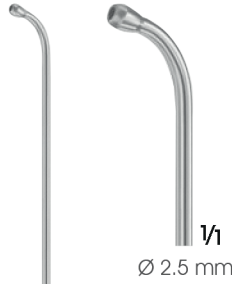

EJ036-00
Spatula/Spatula
14.5 cm

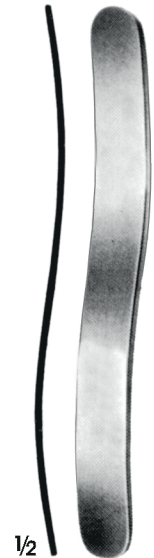

EJ580-00
Spatula/Spatula
14.5 cm



Çalışma boyu
Working length

Tam boy
Total Length

FERGUSSON

Çalışma boyu Working length	11 cm	13 cm	16 cm	20 cm	
Tam boy Total Length	19.5 cm	21.5 cm	24.5 cm	28 cm	Ø
EJ215-01	EJ215-21	EJ215-51	EJ215-81	1.5 mm	
EJ215-02	EJ215-22	EJ215-52	EJ215-82	2.0 mm	
EJ215-03	EJ215-23	EJ215-53	EJ215-83	2.5 mm	
EJ215-04	EJ215-24	EJ215-54	EJ215-84	3.0 mm	
EJ215-06	EJ215-26	EJ215-56	EJ215-86	4.0 mm	
EJ215-08	EJ215-28	EJ215-58	EJ215-88	5.0 mm	

Parmak kumandalı, temizleme telli
parmak basma yüzeyi yatay LUER bağlantı
With finger cut-of and styled
Thumb piece 90° to curve, With LUER hub



Olive
Ø 6-9 mm

FERGUSSON

EJ220-02 Ø 4 mm
İzoleli, parmak kumandalı,
temizleme telli
parmak basma yüzeyi yatay
LUER bağlantı
Isolated, with finger cut-of and stylet,
thumb piece 90° to curve, with LUER
hub
18 cm

1/2

Olive
Ø 6-9 mm

FRAZIER

EJ220-00 Ø 3 mm
EJ220-01 Ø 5 mm
Parmak kumandalı, temizleme
telli parmak basma yüzeyi
yatay LUER bağlantı
With finger cut-of and stylet
Thumb piece 90° to curve,
with LUER hub
18 cm

1/2

FRAZIER

EJ221-00 Ø 2.3 mm
EJ221-01 Ø 2.7 mm
EJ221-02 Ø 3.4 mm
EJ221-03 Ø 4.0 mm
Parmak kumandalı, temizleme
telli parmak basma yüzeyi yatay
LUER bağlantı
With finger cut-of and stylet
Thumb piece 90° to curve,
with LUER hub
11 cm

1/2



ZOELLNER

- EJ032-01** Ø 26 swg, Ø 0.4 mm
EJ032-02 Ø 24 swg, Ø 0.5 mm
EJ032-04 Ø 22 swg, Ø 0.7 mm
EJ032-06 Ø 20 swg, Ø 1.0 mm
EJ032-08 Ø 18 swg, Ø 1.2 mm
EJ377-01 ve **EJ378-00** için sökülüp takılabilir uçlar
Detachable ends fitting to **EJ377-01** and **EJ378-00**
10'luk paket/Package of 10 pieces

1/1



VERHOEVEN

- EJ729-01** Ø 24 swg, Ø 0.5 mm
EJ729-02 Ø 22 swg, Ø 0.7 mm
EJ729-04 Ø 20 swg, Ø 1.0 mm
EJ729-06 Ø 18 swg, Ø 1.2 mm
EJ729-08 Ø 16 swg, Ø 1.5 mm
Aspiratör ucu, LUER koniği
Suction cannulae with Luer cone
10 cm

1/2

Olive
Ø 7 mm



1/1

HOUSE

- EJ461-01**
Parmak kumandalı emiş adaptörü LUER koniği, LUER bağlantılı
Suction adapter with finger cut-off, LUER cone, LUER hub
5.5 cm

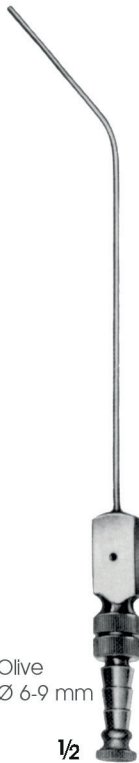

Olive
Ø 6-9 mm

1/2

PLESTER

- EJ212-00** Ø 1.5 mm
EJ212-01 Ø 2.0 mm
EJ212-02 Ø 2.5 mm
EJ212-03 Ø 3.0 mm
Parmak kumandalı, temizleme telli parmak basma yüzeyi baş parmağa paralel LUER bağlantılı
With finger cut-off and stylet, thumb piece parallel to curve, with LUER hub
19.5 cm



Ø 4 mm

Olive
Ø 9 mm

1/2

ADSON
EJ219-00

- Parmak kumandalı
With finger cut-off
19 cm

Ø 3 mm



Olive
Ø 8 mm

1/2

ADSON
EJ232-00

- Aspiratör ucu
Suction cannula
Parmak kumandalı ve temizleme telli
With finger cut-off and stylet
16.5 cm



GILLIES
EJ227-01 Ø 3 mm
Parmak kumandalı ve
temizleme telli
With finger cut-off and stylet
17 cm



LEMPERT
EJ224-01 Ø 2 mm
EJ224-02 Ø 3 mm
Parmak kumandalı ve
temizleme telli
With finger cut-off and stylet
20 cm



FORMBY
EJ225-01 Ø 3.3 mm
21 cm

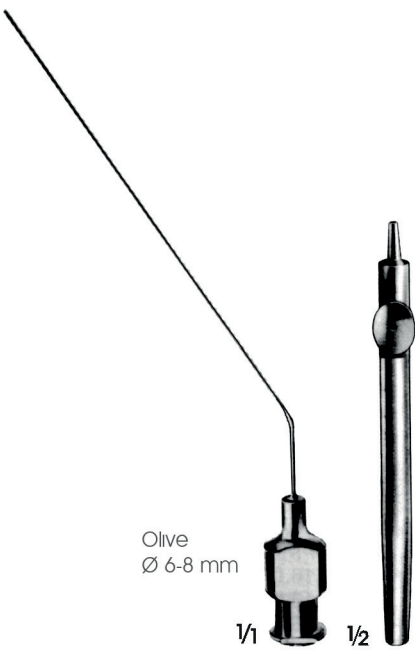

EJ236-10 Komple/Complete
EJ236-00 Sap/Handle
EJ236-01 Ø 0.5 mm
EJ236-02 Ø 0.7 mm
EJ236-03 Ø 1.0 mm
EJ236-04 Ø 1.3 mm
LUER koniği/With LUER cone



WULLSTEIN
EJ238-10 Komple/Complete
EJ238-00 LUER bağlantılı sap
handle with LUER hub
EJ238-01 Ø 0.4 mm
EJ238-02 Ø 0.6 mm
EJ238-03 Ø 0.8 mm



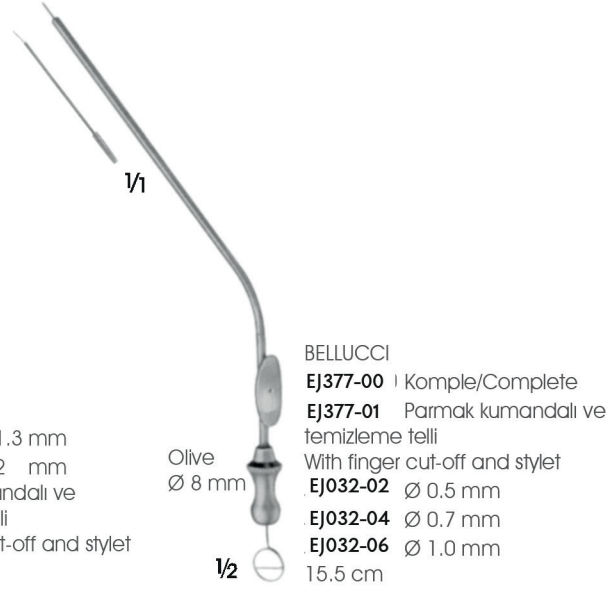

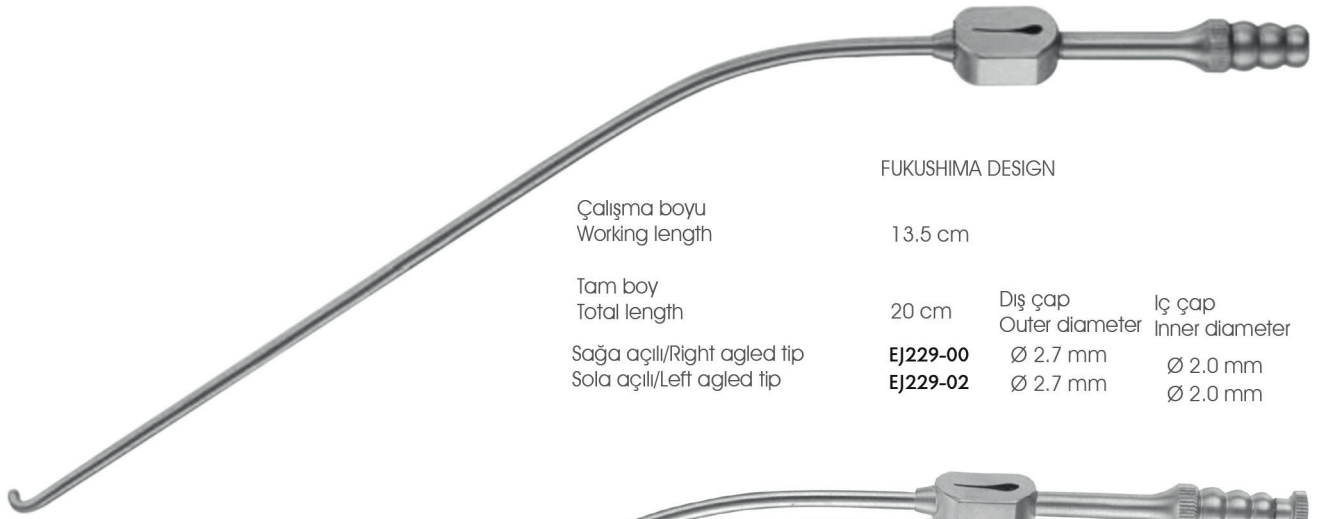

FUKUSHIMA DESIGN

Çalışma boyu
Working length

13.5 cm

Tam boy
Total length

20 cm

Diş çap
Outer diameter

İç çap
Inner diameter

Sağa açılı/Right angled tip
Sola açılı/Left angled tip

EJ229-00

Ø 2.7 mm

Ø 2.0 mm

EJ229-02

Ø 2.7 mm

Ø 2.0 mm

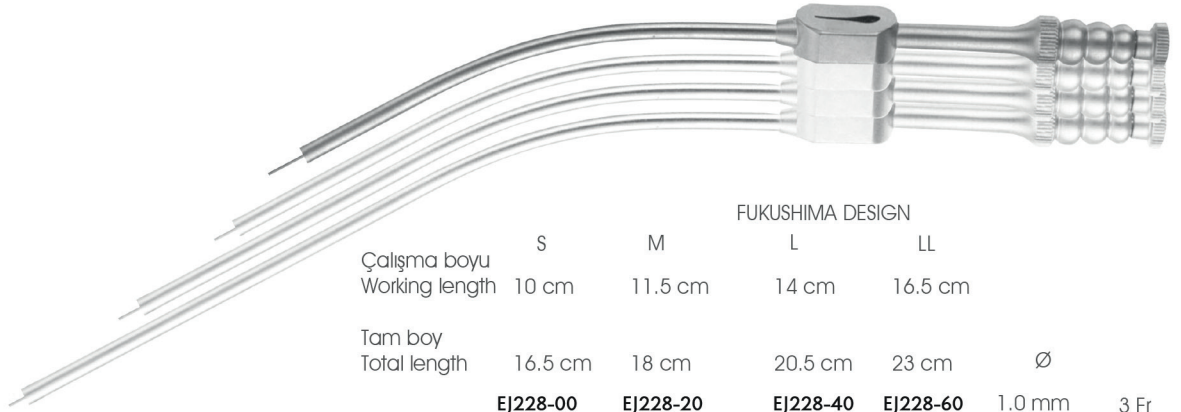

FUKUSHIMA DESIGN

Çalışma boyu
Working length

S

M

L

LL

10 cm

11.5 cm

14 cm

16.5 cm

Tam boy
Total length

16.5 cm

18 cm

20.5 cm

23 cm

Ø

EJ228-00

EJ228-20

EJ228-40

EJ228-60

1.0 mm

3 Fr

EJ228-01

EJ228-21

EJ228-41

EJ228-61

1.4 mm

4 Fr

EJ228-02

EJ228-22

EJ228-42

EJ228-62

1.7 mm

5 Fr

EJ228-03

EJ228-23

EJ228-43

EJ228-63

2.0 mm

6 Fr

EJ228-04

EJ228-24

EJ228-44

EJ228-64

2.3 mm

7 Fr

EJ228-05

EJ228-25

EJ228-45

EJ228-65

2.7 mm

8 Fr

EJ228-06

EJ228-26

EJ228-46

EJ228-66

3.0 mm

9 Fr

EJ228-07

EJ228-27

EJ228-47

EJ228-67

3.3 mm

10 Fr

EJ228-09

EJ228-29

EJ228-49

EJ228-69

4.0 mm

12 Fr

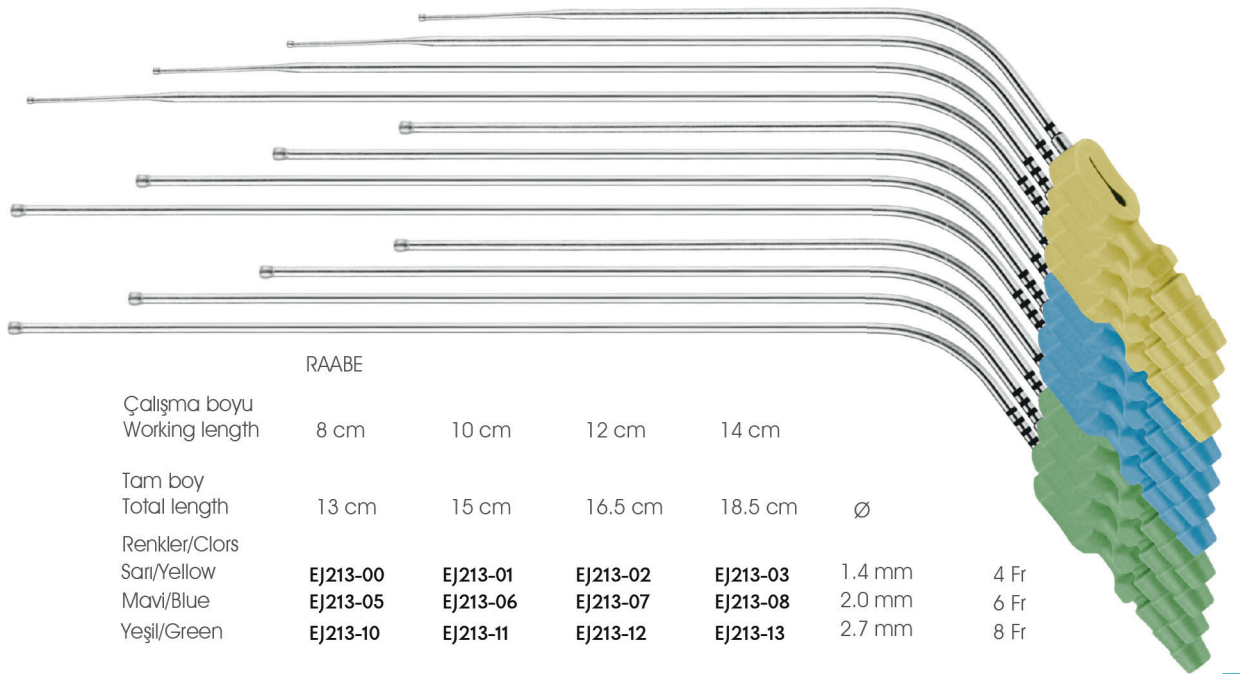

RAABE

Çalışma boyu
Working length

8 cm

10 cm

12 cm

14 cm

Tam boy
Total length

13 cm

15 cm

16.5 cm

18.5 cm

Ø

Renkler/Clors

Sarı/Yellow

EJ213-00

EJ213-01

EJ213-02

EJ213-03

1.4 mm

4 Fr

Mavi/Blue

EJ213-05

EJ213-06

EJ213-07

EJ213-08

2.0 mm

6 Fr

Yeşil/Green

EJ213-10

EJ213-11

EJ213-12

EJ213-13

2.7 mm

8 Fr



EJ604-00

Parmak kumandalı ve temizleme telli
With finger cut-off and stylet

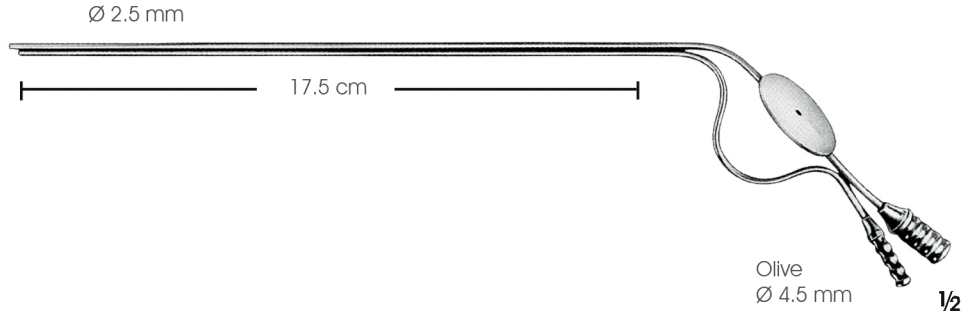

EJ265-00 Ø 2.0 mm

EJ265-01 Ø 2.5 mm

EJ265-02 Ø 3.0 mm

Parmak kumandalı ve temizleme telli
parmak basma yüzeyi yatay
With finger cut-off, thumb piece 90° to curve
25 cm

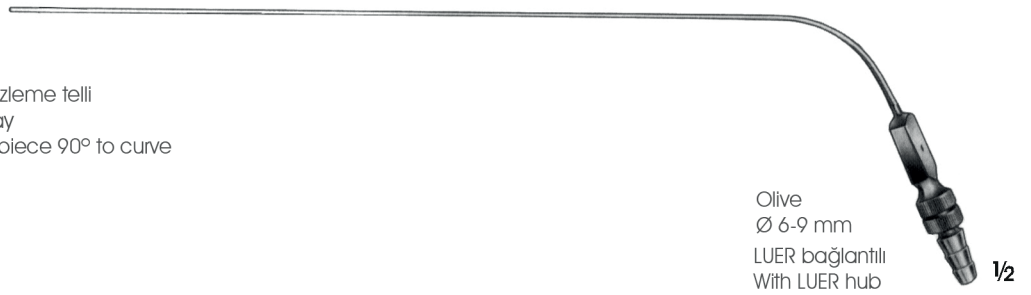

HOUSE

EJ608-00 Ø 0.9 - 0.7 mm

EJ608-01 Ø 1.2 - 0.9 mm

EJ608-02 Ø 1.5 - 1.2 mm

Parmak kumandalı ve temizleme telli
With finger cut-off and stylet

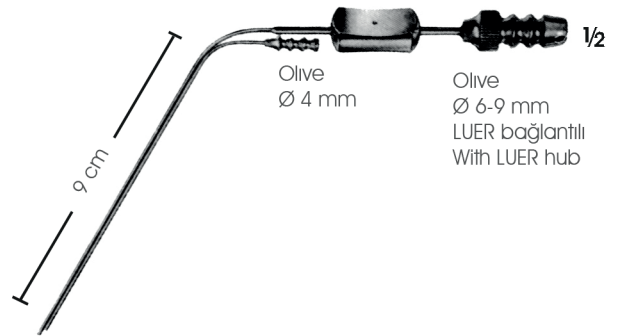

EJ360-00 4 mm

EJ360-01 5 mm

Aspiratör raspa, sivri bayonet tip
Suction raspatories, sharp
bayonet-shaped
20 cm



LANDOLT

EJ361-00 Genişlik/Wide 3.2 mm

Hipofizektomi ve Kbb için aspiratör ucu,
keskin açılı nokta
Dissecting suction tube for hypophysectomie
and ENT, sharp angled point
20 cm



EJ352-00

Uc genişliği 6,5 mm
Tip wide 6,5 mm
Burun aspiratör ucu, LUER bağlantılı
Nasal suction tube, with LUER hub
18 cm

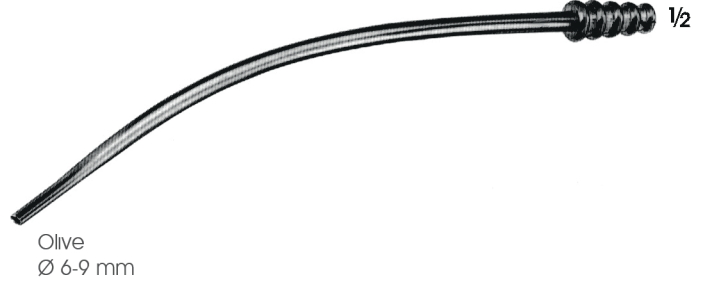

GORNEY

EJ368-00

Aspiratör disektör
Suction dissector
18 cm



NEGUS

EJ367-00

Aspiratör disektör
Suction dissector
21 cm



LOPEZ-REINKE

EJ365-00

Aspirasyonlu Tonsil disektör
Tonsil dissector with suction
device
23.5 cm

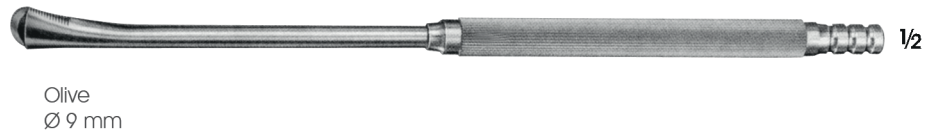

YASARGIL

EJ602-00

Kanül/Cannulae
LUER-LOC koniği
LUER-LOC cone
20 cm

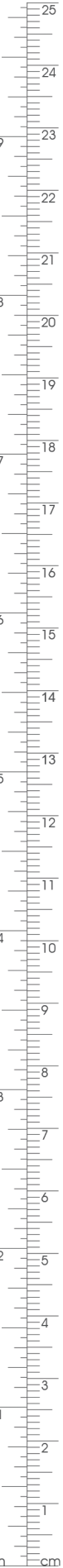

YASARGIL

Aspiratör uçları/Suction tubes

EJ260-00 Ø 1.5 mm	EJ260-01 Ø 1.5 mm	EJ260-02 Ø 1.5 mm	EJ260-03 Ø 1.5 mm
EJ260-04 Ø 2.0 mm	EJ260-05 Ø 2.0 mm	EJ260-06 Ø 2.0 mm	EJ260-07 Ø 2.0 mm
EJ260-08 Ø 2.5 mm	EJ260-09 Ø 2.5 mm	EJ260-10 Ø 2.5 mm	EJ260-11 Ø 2.5 mm
EJ260-12 Ø 3.5 mm 13 cm	EJ260-13 Ø 3.5 mm 15 cm	EJ260-14 Ø 3.5 mm	EJ260-15 Ø 3.5 mm 22 cm
		EJ260-16 Ø 4.5 mm 18 cm	

Olive
Ø 6.5-9 mm

LUER bağlantılı
With LUER hub

Ø 3,5 mm

Ø 2,0 mm

EJ263-00 50 cm

EJ263-01 35 cm

Aspiratör uçları/Suction tubes

Lastik uclu

With rubber tip

Olive
Ø 6- 9 mm

LUER bağlantılı
With LUER hub



ROWBOTHAM

EJ423-00

Kanül/Cannulae
29.5 cm



MAGILL

EJ422-01 Ø 3.0 mm

EJ422-02 Ø 3.5 mm

EJ422-03 Ø 4.0 mm

Magil emiş kanülü

Stylet for magill suction tubes
24.5 cm

EJ400-00

Büyük miktarda sıvı temizlemek için
For clearing large quantities of fluid
19 cm



EJ415-00

Delmek için trokar
Trocar, for puncturing
17 cm



EJ418-00

Regülatör ve parmak kumandalı
aspiratör adaptörü
Suction handle, with vacuum regulator
and finger cut-off, brass, mirror-finish
chromium-plated
15 cm

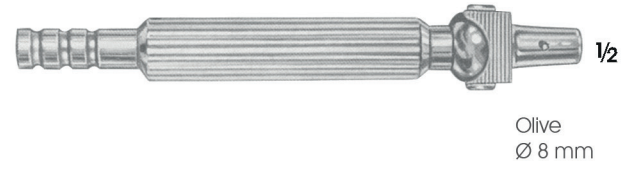

EJ406-00

Çift eğimli genel cerrahi için
Double curved, for general surgery
23 cm



EJ432-00

Ø 9 mm
Üniversal çift eğimli kanül
Universal cannule, double curved
23 cm



POOL

EJ436-00

Aspiratör kanülü, vidalanabilir dış tüpü ile
Suction cannulla, with outer tube to be
screwed off
22.5 cm

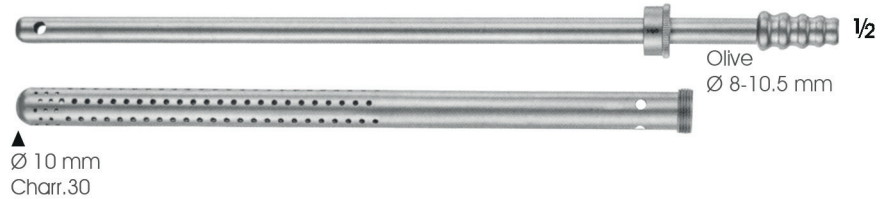

POOL

EJ437-00

Aspiratör kanülü, vidalanabilir dış tüpü ile
Suction cannulla, with outer tube to be
screwed off
22.5 cm

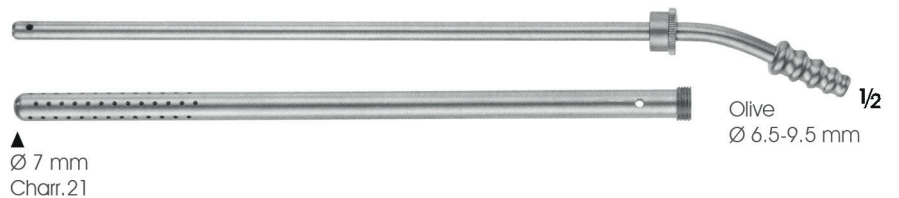

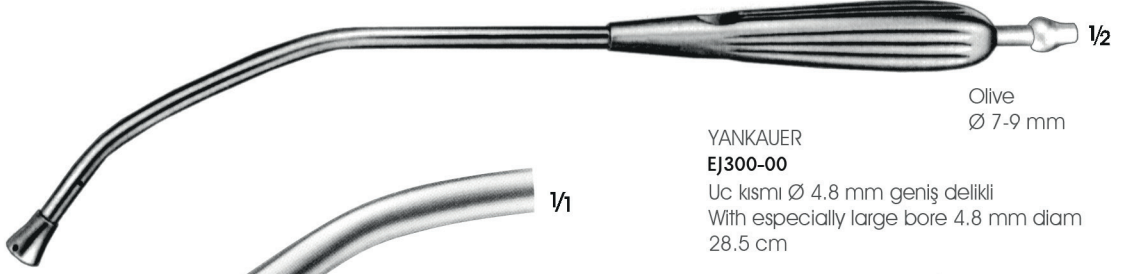

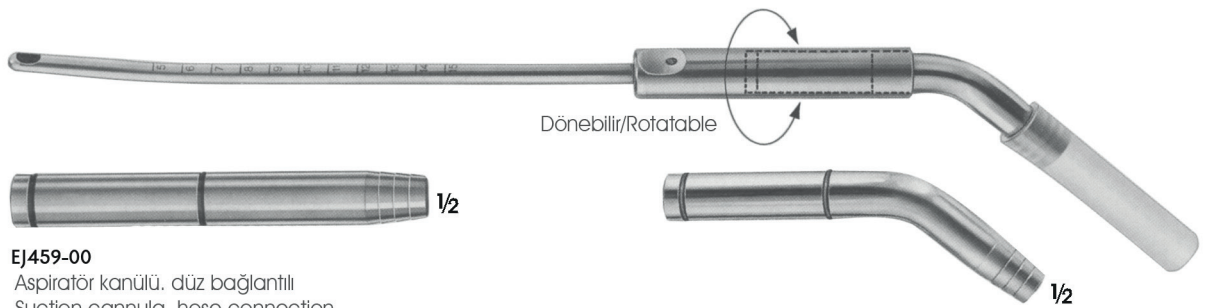
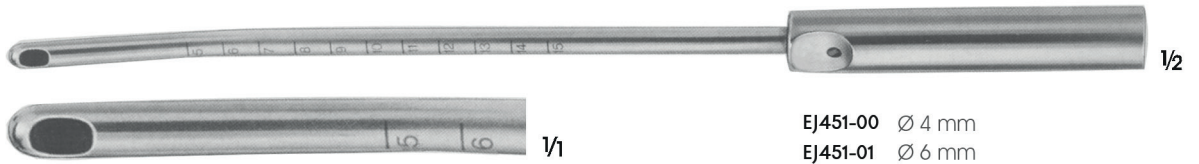



EJ102-00
4 ucu ile birlikte
sökülebilir trokar
Trocar with interchangeable
tips (4 pcs.)

PIERCE
EJ108-00 Ø 4.0 mm
Antrum trokar
Antrum trocar

KRAUSE
EJ110-00 1 Ø 4.0 mm
Antrum trokar
Antrum trocar

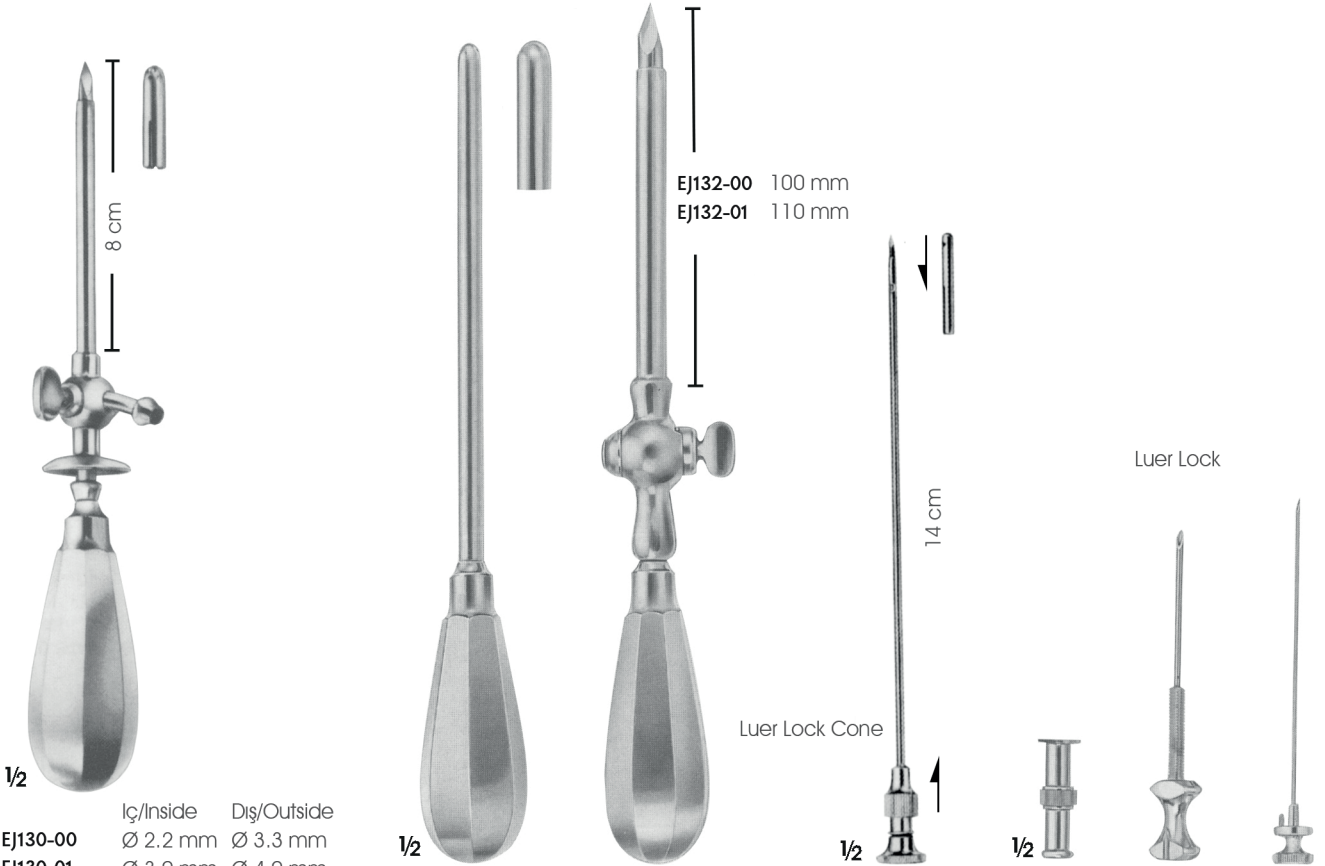

EJ130-00 İç/Inside Dış/Outside
EJ130-01 Ø 2.2 mm Ø 3.3 mm
EJ130-02 Ø 3.0 mm Ø 4.0 mm
EJ130-03 Ø 4.0 mm Ø 5.0 mm
Yandan boşaltılmalı musluklu, karın
delme trokari
For abdominal puncture, with
stop-cock and lateral drain.

BUELAU
EJ132-00 İç/Inside Dış/Outside
EJ132-01 Ø 6.5 mm Ø 8.0 mm
Ø 9.0 mm Ø 10.0 mm
Ampiyem trokar
Empyema trocar

LANDAU
EJ138-00 Ø 2 mm
Pelvik apse trokar
Pelvic abscess trocar

KLIMA-ROSEGGER
EJ706-00 35 x 1,8 mm
Göğüs kemiği delici iğne
Sternal puncture needle



Charr.

- EF800-00 8
- EF800-01 10
- EF800-02 12
- EF800-03 14
- EF800-04 16
- EF800-05 18

Arkası tırtıllı, bıçak tip, hafif eğri
With thread, knife tip, slightly curved
19 cm

1/2

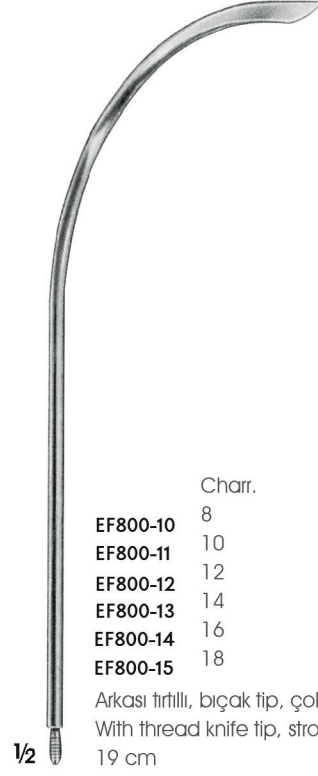

Charr.

- EF800-10 8
- EF800-11 10
- EF800-12 12
- EF800-13 14
- EF800-14 16
- EF800-15 18

Arkası tırtıllı, bıçak tip, çok eğri
With thread knife tip, strongly curved
19 cm

1/2



Charr.

- EF800-20 8
- EF800-21 10
- EF800-22 12
- EF800-23 14
- EF800-24 16
- EF800-25 18

Arkası tırtıllı, bistüri tip, hafif eğri
With thread, lancet tip, slightly curved
19 cm

1/2



Charr.

- EF800-30 8
- EF800-31 10
- EF800-32 12
- EF800-33 14
- EF800-34 16
- EF800-35 18

Arkası tırtıllı, trokar tip, hafif eğri
With thread, trocar tip, slightly curved
19 cm

1/2



