

EG

Hemostatik Pensler, Diseksiyon Pensleri, Histerektomi Pensleri  
Haemostatic Forceps, Dissecting Forceps, Hyterectomy Forceps



Geçici damar tıkkama için:

Güvenli ve dikkatli şekilde damar kavrama

Sabitlenmiş baskı mesafeli, tırtıklı yüzeyli bleydler

Kapama kuvveti klipsin ağızlarının 1/3 mesafesinde 1 mm aralık durumunda ölçülür.

For temporary occlusion :

Safe and careful gripping of vessel

Blades with serrated surface and rigidly fixed pressure feature

Closing force is measured at 1/3 of the blades a 1 mm opening

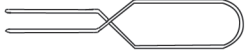

BIEMER

**ES001-00**

Çene uzunluğu/Lenght of jaws 6 mm

Açıklık/Opening 4 mm

Kapanma kuvveti/Closing force 30-40 gr. (0.29 - 0.39 N)



**ES002-00**

Çene Uzunluğu/Lenght of jaws 9 mm

Açıklık/Opening 5 mm

Kapanma kuvveti/Closing force 30-40 gr. (0.29 - 0.39 N)



BIEMER

**ES003-00**

Çene uzunluğu/Lenght of jaws 9 mm

Açıklık/Opening 5 mm

Kapanma kuvveti/Closing force 20-25 gr. (0.20 - 0.25 N)



for vessel Ø 0.5 - 2.0 mm.

S 034.00 ve S 035.00 ile birlikte kullanılır.

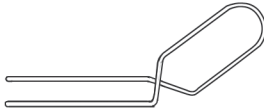

MEHDORN

**ES005-00**

Çene uzunluğu/Lenght of jaws 1 mm

Açıklık/Opening 4 mm

Kapanma kuvveti/Closing force 10-15 gr. (0.10 - 0.15 N)



MEHDORN

**ES005-01**

Çene uzunluğu/Lenght of jaws 1.4 mm

Açıklık/Opening 4 mm

Kapanma kuvveti/Closing force 15-20 gr. (0.15 - 0.20 N)



MEHDORN

**ES005-05**

Çene uzunluğu/Lenght of jaws 1 mm

Açıklık/Opening 6 mm

Kapanma kuvveti/Closing force 10-15 gr. (0.10 - 0.15 N)



MEHDORN

**ES005-06**

Çene uzunluğu/Lenght of jaws 1.4 mm

Açıklık/Opening 6 mm

Kapanma kuvveti/Closing force 15-20 gr. (0.15 - 0.20 N)



for vessel Ø 0.5 - 2.0 mm.

S 032.00 ile birlikte kullanılır.

Mikro damar anastomileri için:

Güvenli ve dikkatli şekilde damar kavrama.

Sabitlenmiş baskı mesafeli, tırtıllı yüzeyli bleydler.

Klipsler arası mesafe ayarlanabilir.

Bükerek otomatik sabitleme.

For micro vessel anastomosis:

Safe and careful griping of vessel.

Blades with serrated surface and rigidly fixed pressure feature.

Adjustable distance between clips.

Automatic fixation by tilling



BIEMER-MÜLLER

**ES010-00**

Çene uzunluğu/Lenght of jaws.6 mm

Açıklık/Opening 4 mm

Kapanma kuvveti/Closing force 30-40 gr.

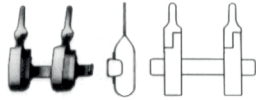

BIEMER-MÜLLER

**ES011-00**

Çene uzunluğu/Lenght of jaws.4.5 mm

Açıklık/Opening 3 mm

Kapanma kuvveti/Closing force 25-30 gr.

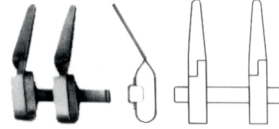

BIEMER-MÜLLER

**ES012-00**

Çene uzunluğu/Lenght of jaws.9 mm

Açıklık/Opening 5 mm

Kapanma kuvveti/Closing force 25-30 gr.

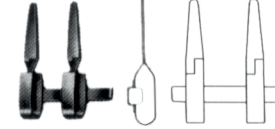

BIEMER-MÜLLER

**ES013-00**

Çene uzunluğu/Lenght of jaws.9 mm

Açıklık/Opening 5 mm

Kapanma kuvveti/Closing force 25-30 gr.

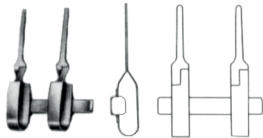

BIEMER-MÜLLER

**ES014-00**

Çene uzunluğu/Lenght of jaws.9 mm

Açıklık/Opening 5 mm

Kapanma kuvveti/Closing force 25-30 gr.

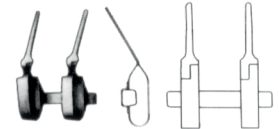

BIEMER-MÜLLER

**ES015-00**

Çene uzunluğu/Lenght of jaws.9 mm

Açıklık/Opening 5 mm

Kapanma kuvveti/Closing force 25-30 gr.

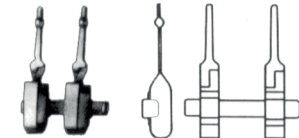

MÜLLER

**ES020-00**

Kapanma kuvveti/Closing force. 25-30 gr.

Ø 1 mm

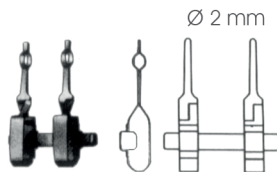

MÜLLER

**ES021-00**

Kapanma kuvveti/Closing force. 25-30 gr.

Ø 2 mm

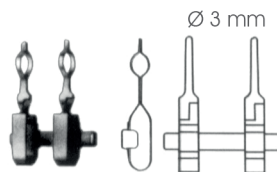

MÜLLER

**ES022-00**

Kapanma kuvveti/Closing force. 25-30 gr.

Ø 3 mm

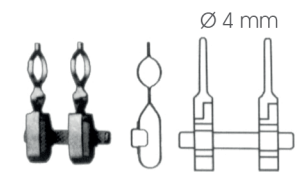

MÜLLER

**ES023-00**

Kapanma kuvveti/Closing force. 25-30 gr.

Ø 4 mm

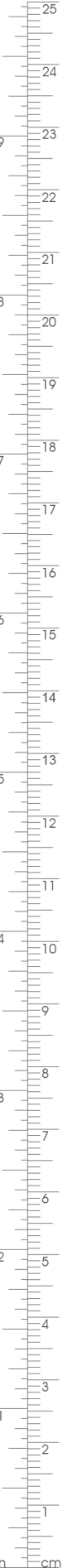



1/1

BIEMER  
**ES035-00**  
Kiltsiz/Without lock

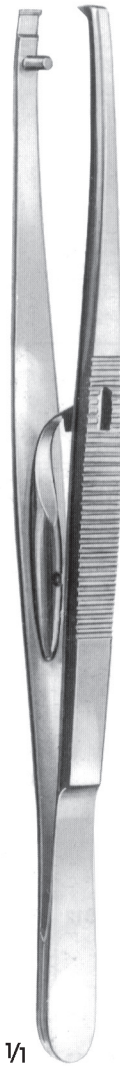

1/1

BIEMER  
**ES034-00**  
Kilitli/With lock



1/1



1/1

BIEMER  
**ES024-00**  
Uygulama pensetleri, damar klipsleri,  
BIEMER-MÜLLER ve MÜLLER aproksi-  
matör.  
Applying forceps for BIEMER  
vessel approximator  
14.5 cm



1/1

BIEMER  
**ES010-01**  
Komple/Complete  
**ES010-00**  
Sadece aproksimatör  
Approximator only  
**ES024-00** Klip penset  
Applying Forceps

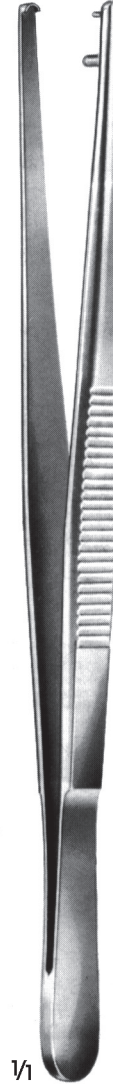

1/1

MEHDORN  
**ES032-00**  
Uygulama pensetleri, MEHDORN  
damar klipsleri  
Applying forceps for MEHDORN  
vessel clips  
15 cm

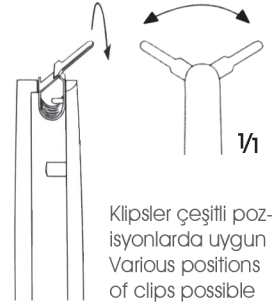

Klipsler çeşitli poz-  
isyonlarda uygun  
Various positions  
of clips possible

BIEMER  
**ES034-00-ES035-00**  
BIEMER damar klipsleri ve BIEMER-MÜLLER ve  
MÜLLER yaklaştırıcılar için başvuru pensleri  
Applying forceps for BIEMER vessel clips and  
BIEMER-MÜLLER and MÜLLER approximators  
14 cm



BIEMER  
**ES025-00**  
Komple Aproksimatör,  
anahtarı ile S 029.00 Approximator, complete  
with key S 029.00

Derin aralıkta mikro damar anastomileri için.

- Güvenli ve dikkatli şekilde damar kavrama.
- Tırtıklı yüzeyli bleydler.
- Anahtar ile (S 029.00) basınç ayarı.
- Anahtar ile (S 029.00) klipsler arası mesafenin ayarlanması ve sabitlenmesi.

For micro vessel anastomosis

- Safe and careful gripping of vessel.
- Blades with serrated blade surface
- Pressure adjustment with use of key(S 029.00)
- Adjustment of distance between blades and fixation of blades with a use of key(S 029.00)



BIEMER  
**ES026-00**  
Komple Aproksimatör,  
anahtarı ile S 029.00  
Approximator, complete  
with key S 029.00

Sinir anastomilerine güvenli adaptasyon

- Sinir merkezinin, güçlü patolojik değişiklikleri önleyen hassas iğneler ile delinmesi
- Anahtar(S 029.00) kullanımı ile değiştirilebilir iğneler.
- Anahtar ile iğneler arası mesafenin ayarlanması ve sabitlenmesi

Safe adaptation of nerve anastomoses

- Piercing the nerve center with fine needles that prevents strong pathological changes
- Changeable needles with use of key.(S 029.00)
- Adjustment of distance between needles and fixation of needles with use of key(S 029.00)

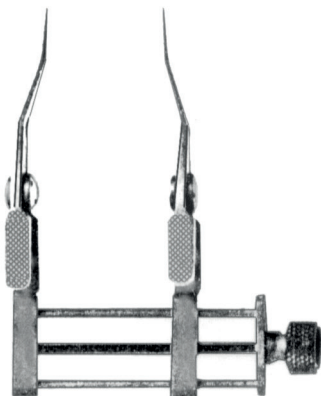

**ES030-00**  
Approximator

Derin aralıkta mikro damar anastomileri için.

- Güvenli ve dikkatli şekilde damar kavrama.
- Tırtıklı yüzeyli bleydler.
- El ile basınç ayarı yapabilmeye özelliği.
- Mesafeyi el ile yakınlaştırma ve uzaklaştırma.

For micro vessel anastomosis

- Safe and careful gripping of vessel.
- Blades with serrated blade surface
- The ability to manually set the pressure
- Distance, zoom in and out manually.



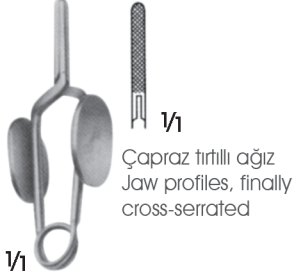

MÜLLER  
**EG0144000**  
Dikiş pensi  
Ligature forceps

Travmatik olmayan damar klipleri, Geçici Non-traumatic Vessel Clips, temporary



MÜLLER  
**EG015-00**  
Kapama kuvveti 50 gr/Düz  
Closing Forceps 50 gr/Straight  
**EG016-00**  
Kapama kuvveti 80 gr/Düz  
Closing forceps 80 gr/Straight

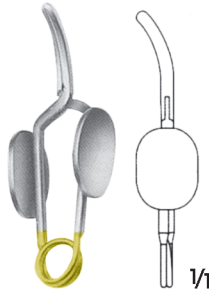

MÜLLER  
**EG015-05**  
Kapama kuvveti 50 gr/Eğri  
Closing forceps 50 gr/Curved  
**EG016-05**  
Kapama kuvveti 80 gr/Eğri  
Closing forceps 80 gr/Curved



MÜLLER  
**EG015-10**  
Kapama kuvveti 50 gr/Eğri  
Closing forceps 50 gr/Curved  
**EG016-10**  
Kapama kuvveti 80 gr/Eğri  
Closing forceps 80 gr/Curved



MÜLLER  
**EG015-15**  
Kapama kuvveti 50 gr/Yana doğru açılı  
Closing forceps 50 gr/Angled to side  
**EG016-15**  
Kapama kuvveti 80 gr/Yana doğru açılı  
Closing forceps 80 gr/Angled to side

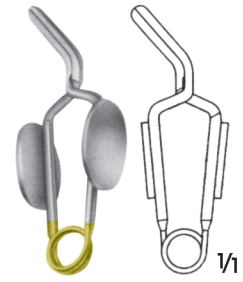

MÜLLER  
**EG015-20**  
Kapama kuvveti 50 gr/Diz bükümlü  
Closing Forceps 50 gr/Knee-bent  
**EG016-20**  
Kapama kuvveti 80 gr/Diz bükümlü  
Closing Forceps 80 gr/Knee-bent

Özellikler :

- Atromatik ağız profili.
- Her iki tarafta kullanılan tutma plakaları kliplerin güvenli bir şekilde uygulanması ve çıkarılmasına yardımcı olur.
- Arter ve toplar damarlar için kesin olarak tanımlanmış kapama basınçları.
- Damar klemplerinin üzerine kapanma basınçları markalanmıştır.

Features :

- Atraumatic mouth profile.
- Holding plates used on both side of the clips ensure safe application and removal.
- Closing pressure of the clips are exactly defined for arterial and venous vessels.
- Closing pressure of the clips is marked on the clips.

De Bakey Diş



Toothing De Bakey

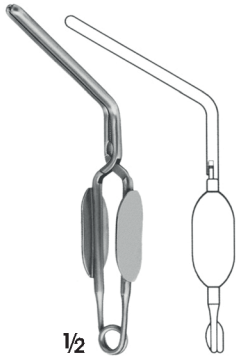

1/2

MÜLLER

**EH113-00**

Kapama kuvveti/Closing force 250 gr

**EH113-01**

Kapama kuvveti/Closing force 350 gr

Düz/Straight



1/2

MÜLLER

**EH114-00**

Kapama kuvveti/Closing force 250 gr

**EH114-01**

Kapama Kuvveti/Closing force 350 gr

Eğri/Curved



1/2

MÜLLER

**EH115-00**

Kapama kuvveti/Closing force 250 gr

**EH115-01**

Kapama kuvveti/Closing force 350 gr

Eğri/Curved



1/2

MÜLLER

**EH116-00**

Kapama kuvveti/Closing force 250 gr

**EH116-01**

Kapama Kuvveti/Closing Force 350 gr

Diz bükümlü/Knee-bent





1/1

Toplam boy Ağız uzunluğu  
Total length Length of jaws

DIEFFENBACH

**EG020-00** 38 mm 12 mm  
**EG020-01** 48 mm 16 mm



1/1

Toplam boy Ağız uzunluğu  
Total length Length of jaws

DIEFFENBACH

**EG021-00** 38 mm 12 mm  
**EG021-01** 48 mm 16 mm



1/1

Toplam boy Ağız uzunluğu  
Total length Length of jaws

DIEFFENBACH

**EG022-00** 58 mm 16 mm



1/1

Toplam boy Ağız uzunluğu  
Total length Length of jaws

DIEFFENBACH

**EG023-00** 58 mm 16 mm



Toplam boy Ağız uzunluğu  
Total length Length of jaws

DE BAKEY-HESS

**EG030-00** 5 mm 20mm  
**EG030-01** 5,7 mm 30mm



Toplam boy Ağız uzunluğu  
Total length Length of jaws

JOHNS-HOPKINS

**EG024-00** 38 mm 12 mm  
**EG024-01** 48 mm 17 mm  
**EG024-02** 56 mm 25 mm  
**EG024-03** 63 mm 30 mm  
**EG024-04** 70 mm 33 mm  
**EG024-05** 80 mm 42 mm  
**EG024-06** 91 mm 52 mm

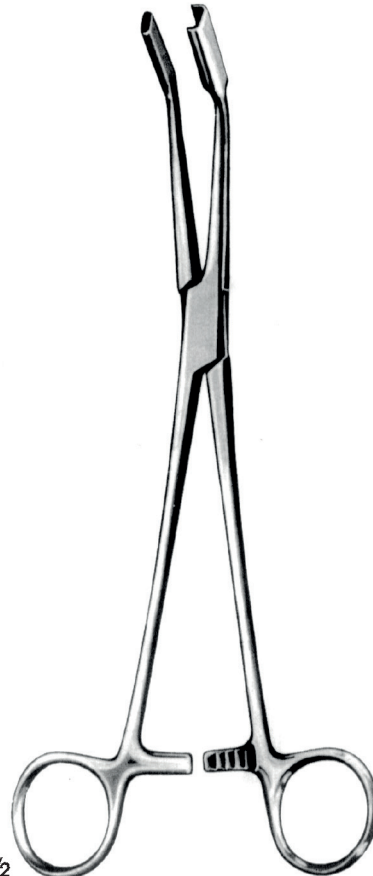

1/2

JOHNS-HOPKINS

**EG026-00**

Buldog klemplerin takılması ve çıkarılması için pens

**EG020-00-EG030-01** ve

**EH120-00-EH121-03**

Forceps for applying and removing bulldog clamps

**EG020-00-EG030-01** and **EH120-00-EH121-03**  
24 cm



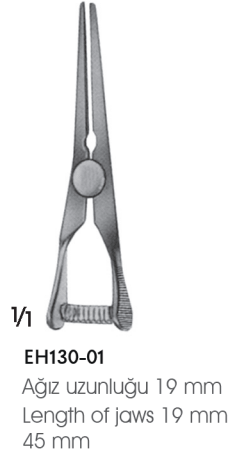
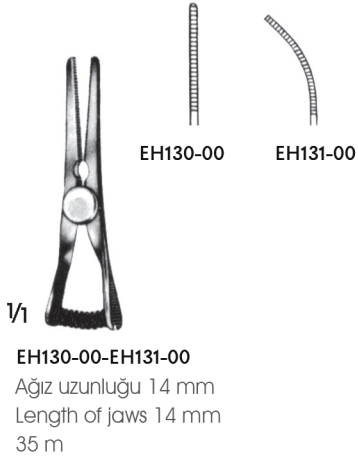



De Bakey Diş



Toothing De Bakey

Kapanma kuvveti 180 gr.

Closing force 180 gr.



1/1

**EH105-00**

Ağız uzunluğu 10 mm  
Length of jaws 10 mm  
Düz/Straight  
5 cm



1/1

**EH105-02**

Ağız uzunluğu 14 mm  
Length of jaws 14 mm  
Düz/Straight  
5.5 cm



1/1

**EH105-04**

Ağız uzunluğu 20 mm  
Length of jaws 20 mm  
Düz/Straight  
6 cm



1/1

**EH106-00**

Ağız uzunluğu 20 mm  
Length of jaws 20 mm  
Eğri/Curved  
5.5 cm



55°

1/1

**EH107-00**

Ağız uzunluğu 10 mm  
Length of jaws 10 mm  
Açılı/Angled  
5 cm



55°

1/1

**EH107-01**

Ağız uzunluğu 14 mm  
Length of jaws 14 mm  
Açılı/Angled  
5 cm



55°

1/1

**EH107-02**

Ağız uzunluğu 20 mm  
Length of jaws 20 mm  
Açılı/Angled  
5.5 cm

De Bakey Diş



Toothing De BAKEY



DE BAKEY  
**EH137-00**  
Ağız uzunluğu 27 mm  
Length of jaws 27 mm  
4.8 cm



DE BAKEY  
**EH138-01**  
Ağız uzunluğu 38 mm  
Length of jaws 38 mm  
7.3 cm



DE BAKEY  
**EH139-00**  
Ağız uzunluğu 42 mm  
Length of jaws 42 mm  
10 cm

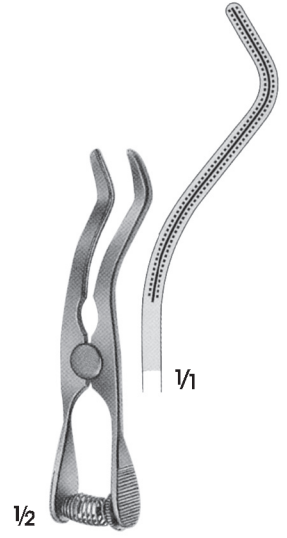

DE BAKEY  
**EH140-00**  
Ağız uzunluğu 54 mm  
Length of jaws 54 mm  
9.5 cm



DE BAKEY  
**EH136-00**  
Ağız uzunluğu 27 mm  
Length of jaws 27 mm  
5 cm



GLOVER  
**EH134-00**  
Ağız uzunluğu 20 mm  
Length of jaws 20 mm  
5.2 cm



	Toplam boy Total length	Ağız uzunluğu Length of jaws
GLOVER <b>EH136-01</b>	6.8 cm	33 mm
<b>EH136-02</b>	9.6 cm	50 mm
<b>EH136-03</b>	11.7 cm	69 mm



	Toplam boy Total length	Ağız uzunluğu Length of jaws
GLOVER <b>EH137-01</b>	6.5 cm	25 mm
<b>EH137-02</b>	9.1 cm	50 mm
<b>EH137-03</b>	11 cm	69 mm



	Toplam boy Total length	Ağız uzunluğu Length of jaws
DE BAKEY <b>EH120-00</b>	8.0 cm	25 mm
<b>EH120-01</b>	9.0 cm	35 mm
<b>EH120-02</b>	10.5 cm	50 mm
<b>EH120-03</b>	12.4 cm	68 mm



	Toplam boy Total length	Ağız uzunluğu Length of jaws
DE BAKEY <b>EH121-00</b>	7.8 cm	23 mm
<b>EH121-01</b>	8.6 cm	31 mm
<b>EH121-02</b>	9.7 cm	42 mm
<b>EH121-03</b>	11.4 cm	58 mm



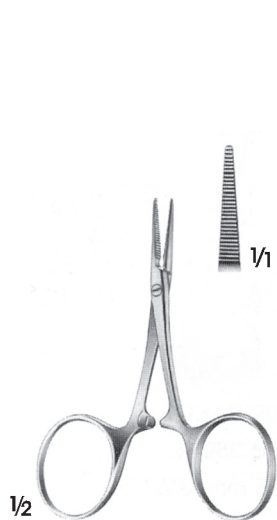

CARREL  
EG609-00  
8.5 cm

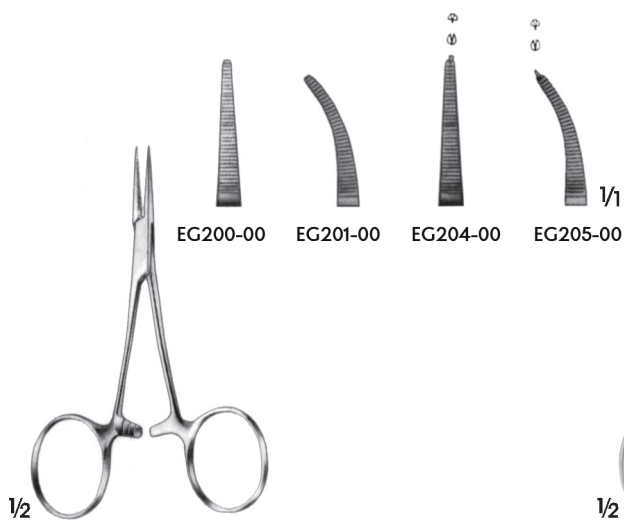

BABY-MOSQUITO  
(HARTMANN)  
EG200-00-EG205-00  
10 cm

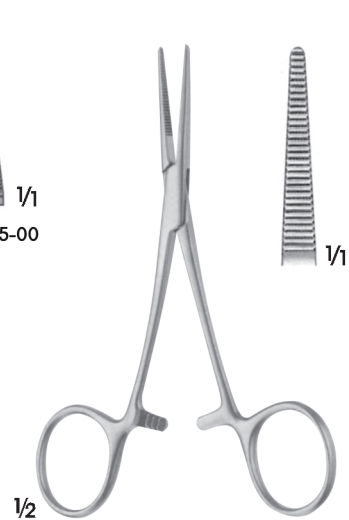

DUNHILL  
EG212-00  
12.5 cm

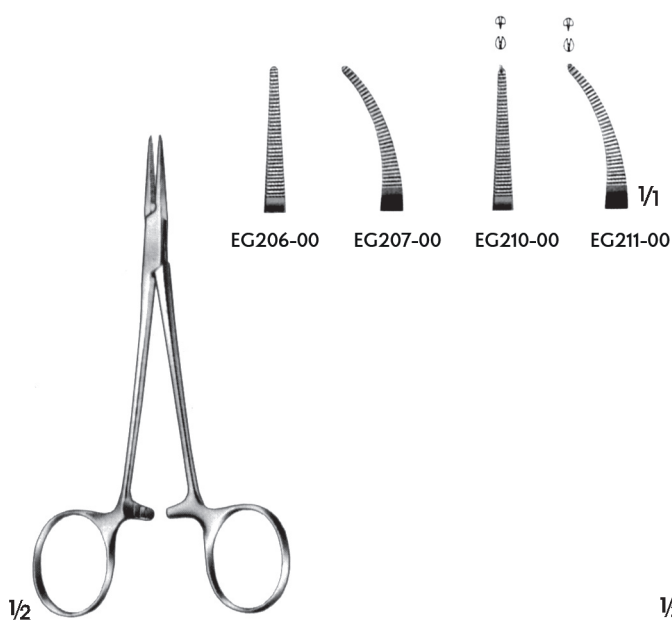

MICRO-HALSTED  
EG206-00-EG211-00  
12.5 cm

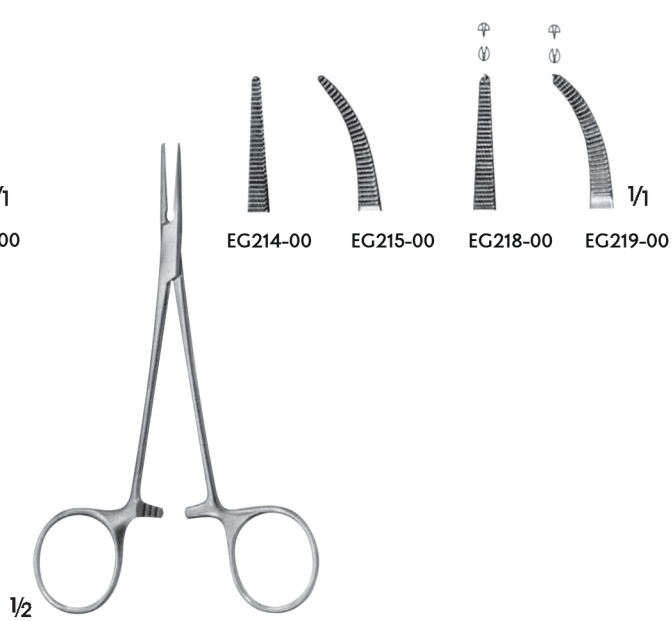

HALSTED-MOSQUITO  
EG214-00-EG219-00  
12.5 cm



BABY-CRILE  
EG220-00-EG227-00  
14 cm

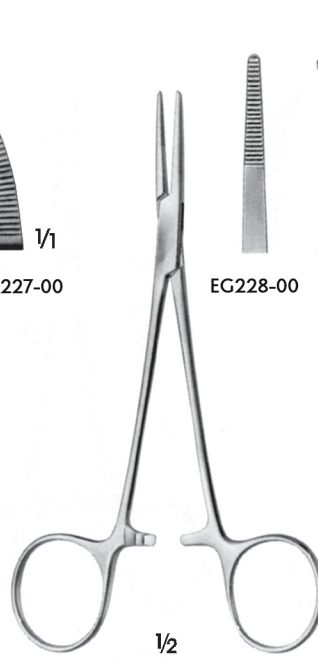
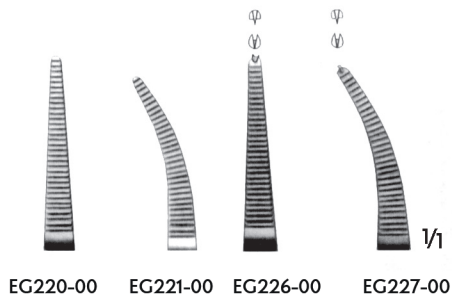

CAIRNS  
EG228-00-EG229-00  
15 cm

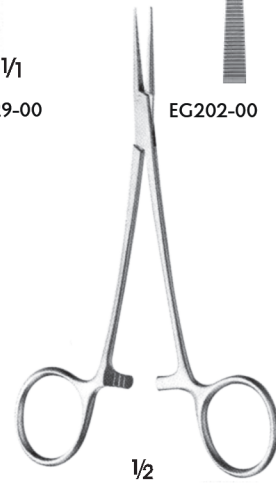
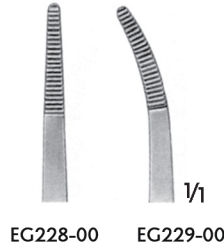

JACOBSON  
EG202-00-EG203-00  
12.5 cm

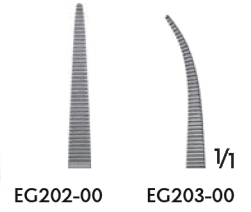

PROVIDENCE-HOSPITAL  
EG230-00-EG231-00  
14 cm

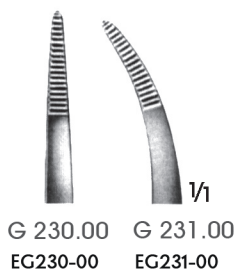

KELLY  
EG234-00-EG235-00  
14 cm

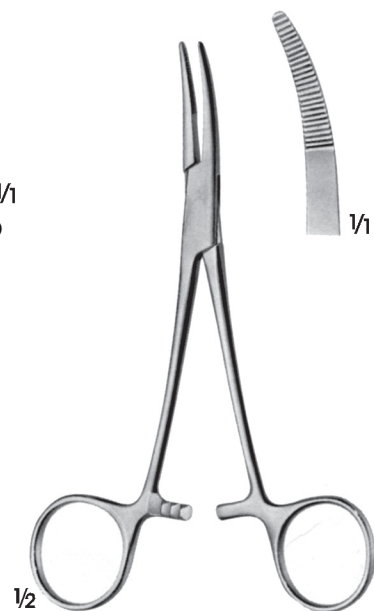
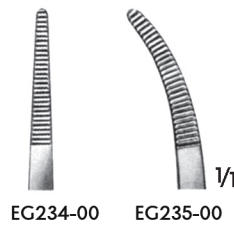

MOYNIHAN  
EG233-00  
Yana eğimli/Curved to side  
15 cm

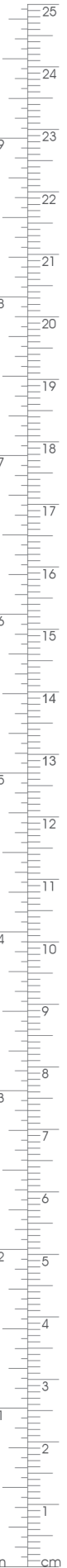



**CAIRNS**  
**EG237-00**  
Yana eğimli/Curved to side  
14.5 cm



**DANDY**  
**EG238-00-EG239-00**  
Yana eğimli/Curved to side  
14 cm



**CRILE**  
**EG240-00-EG245-00**  
14 cm

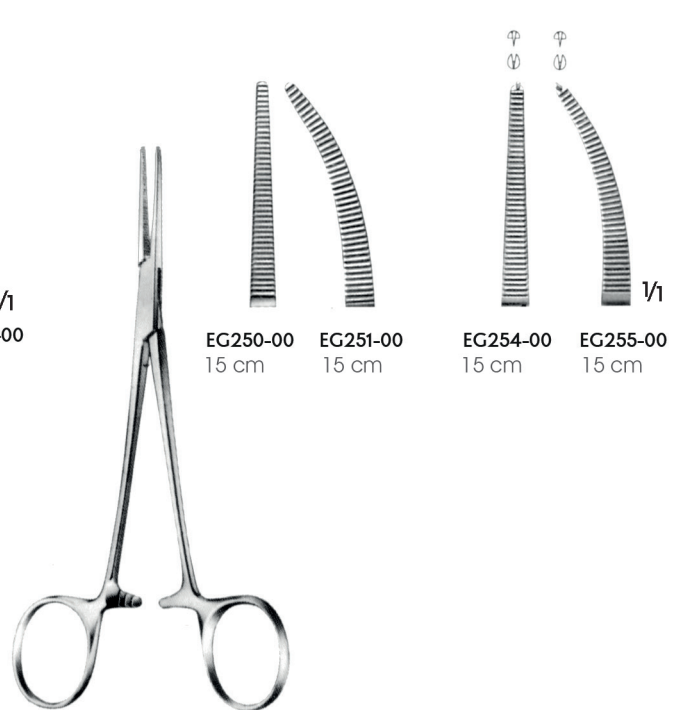

**LERICHE**  
**EG250-00-EG255-00**

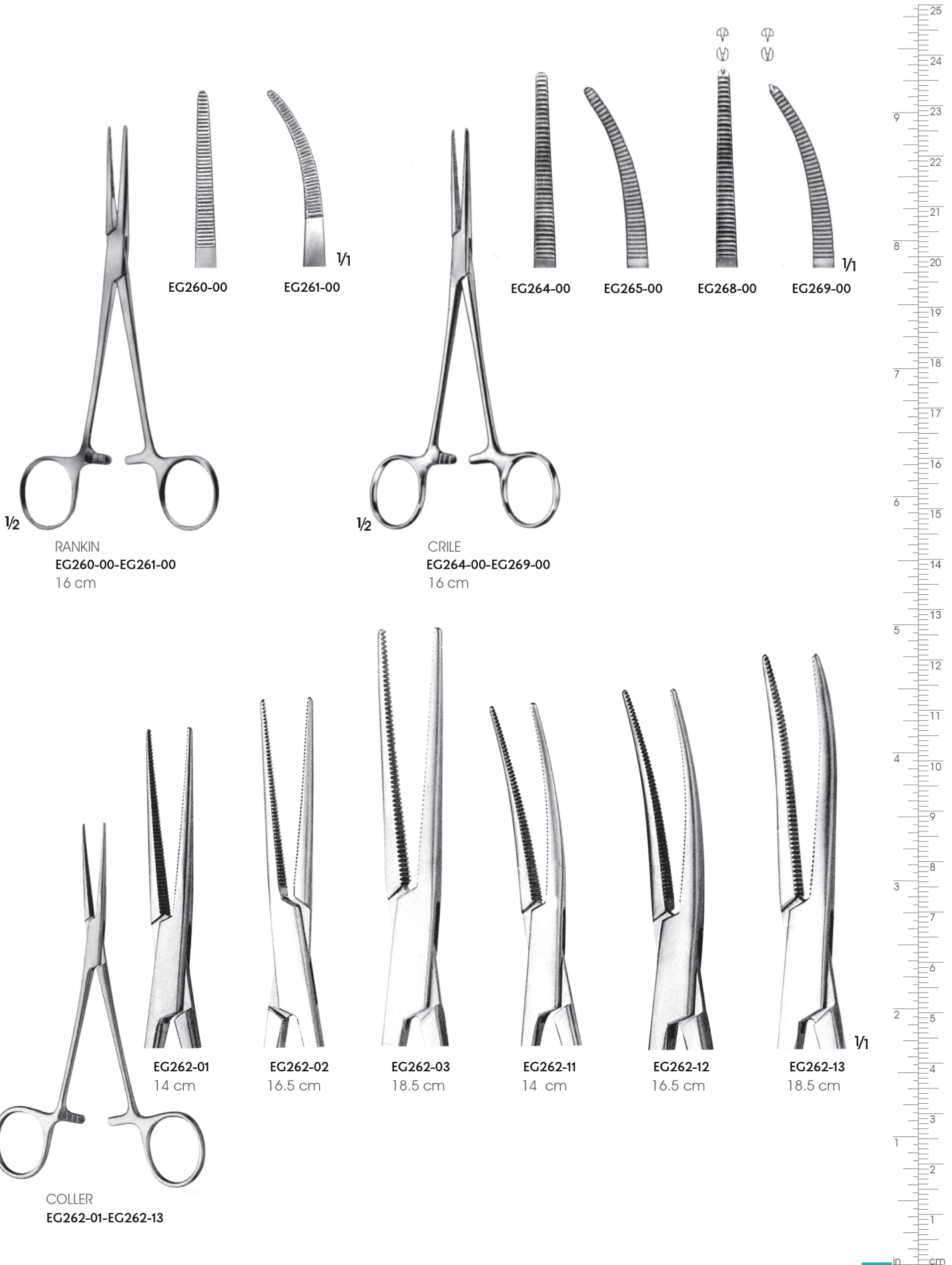



EG270-00



EG271-00

DIXON-LOVELACE  
EG270-00-EG271-00  
16 cm



FUCHSIG  
EG274-00  
19.5 cm

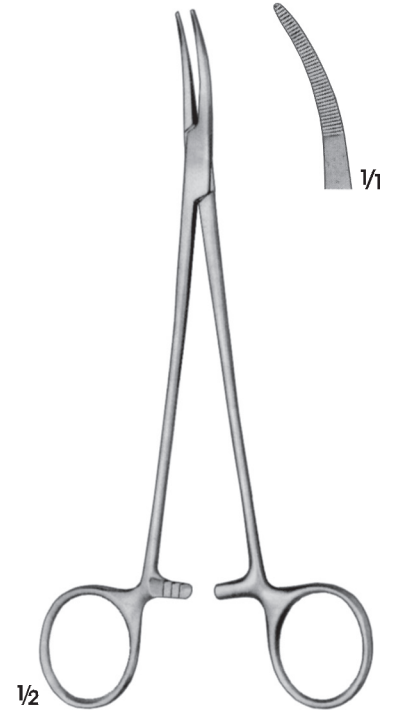

NISSEN  
EG275-00  
18.5 cm

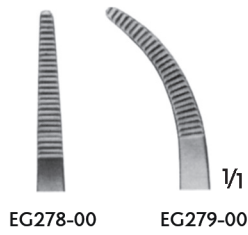
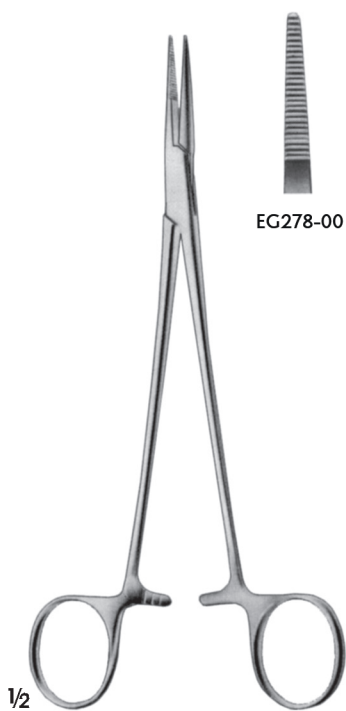

EG278-00

EG279-00

ADSON  
EG278-00-EG279-00  
18.5 cm

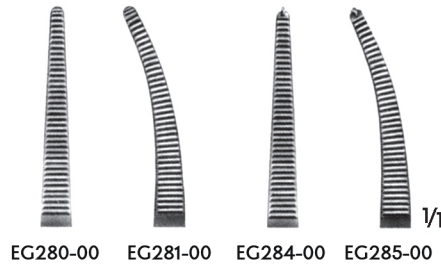
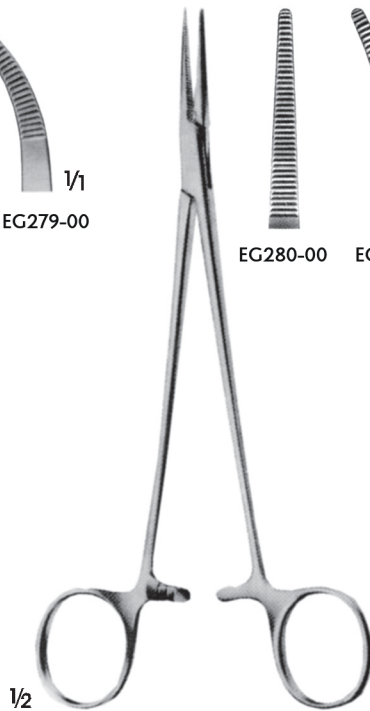

EG280-00

EG281-00

EG284-00

EG285-00

HALSTED  
EG280-00-EG285-00  
18.5 cm

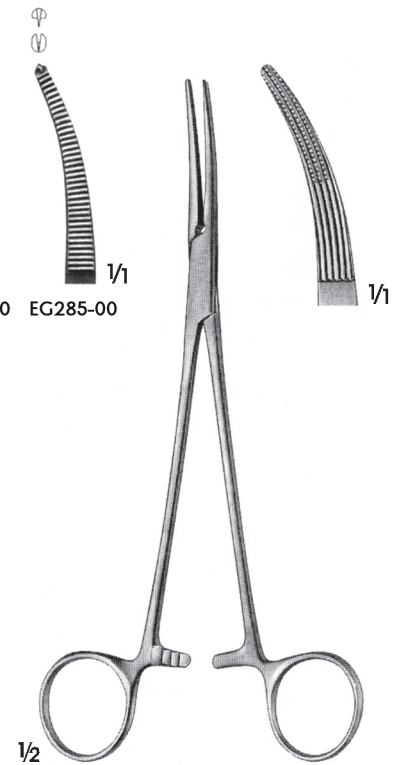

GREY-TURNER  
EG286-00  
18 cm





BIRKETT  
EG288-00-EG289-00  
18.5 cm

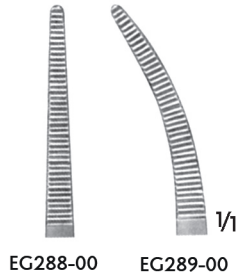

HALSTED-MOSQUITUO  
EG290-00-EG295-00  
20 cm

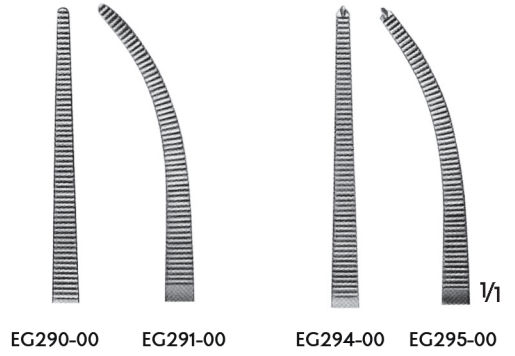

FRASER-KELLY(CRILE)  
EG276-00  
18 cm

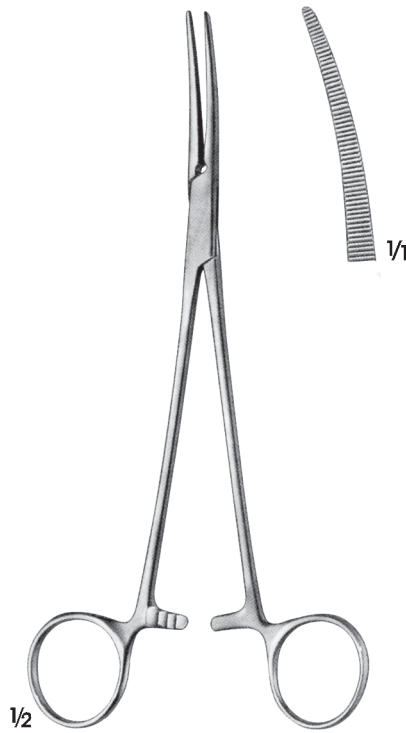
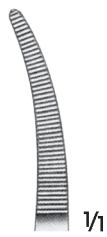

DUNHILL  
EG277-00  
19 cm

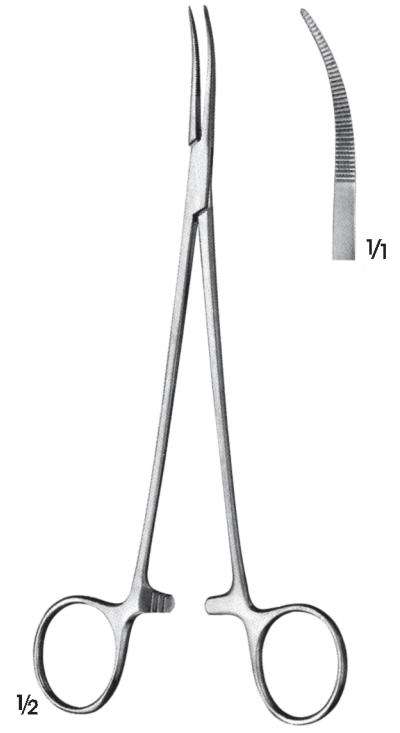
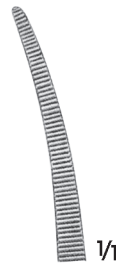

JACOBSON  
EG273-00  
19 cm



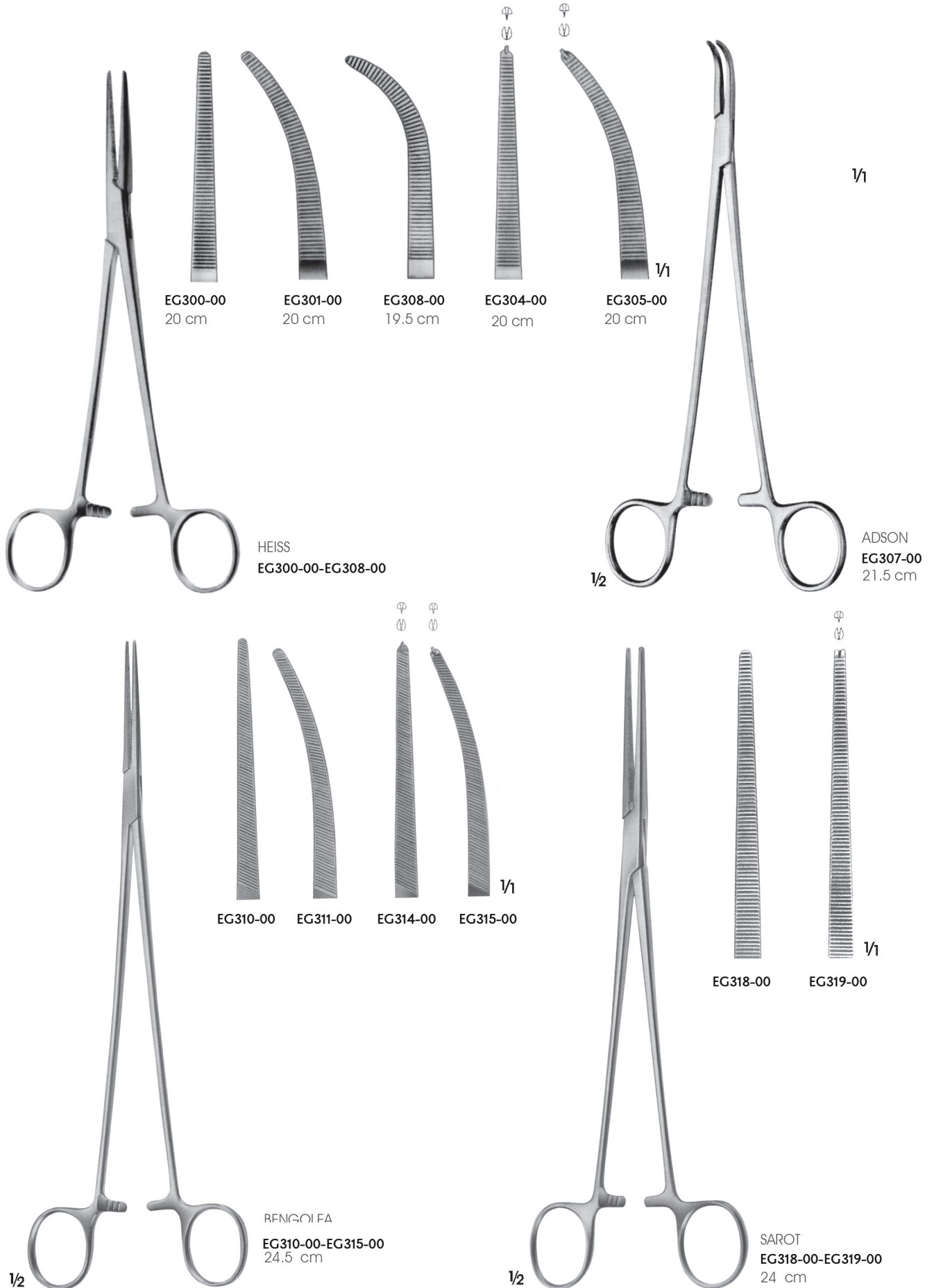

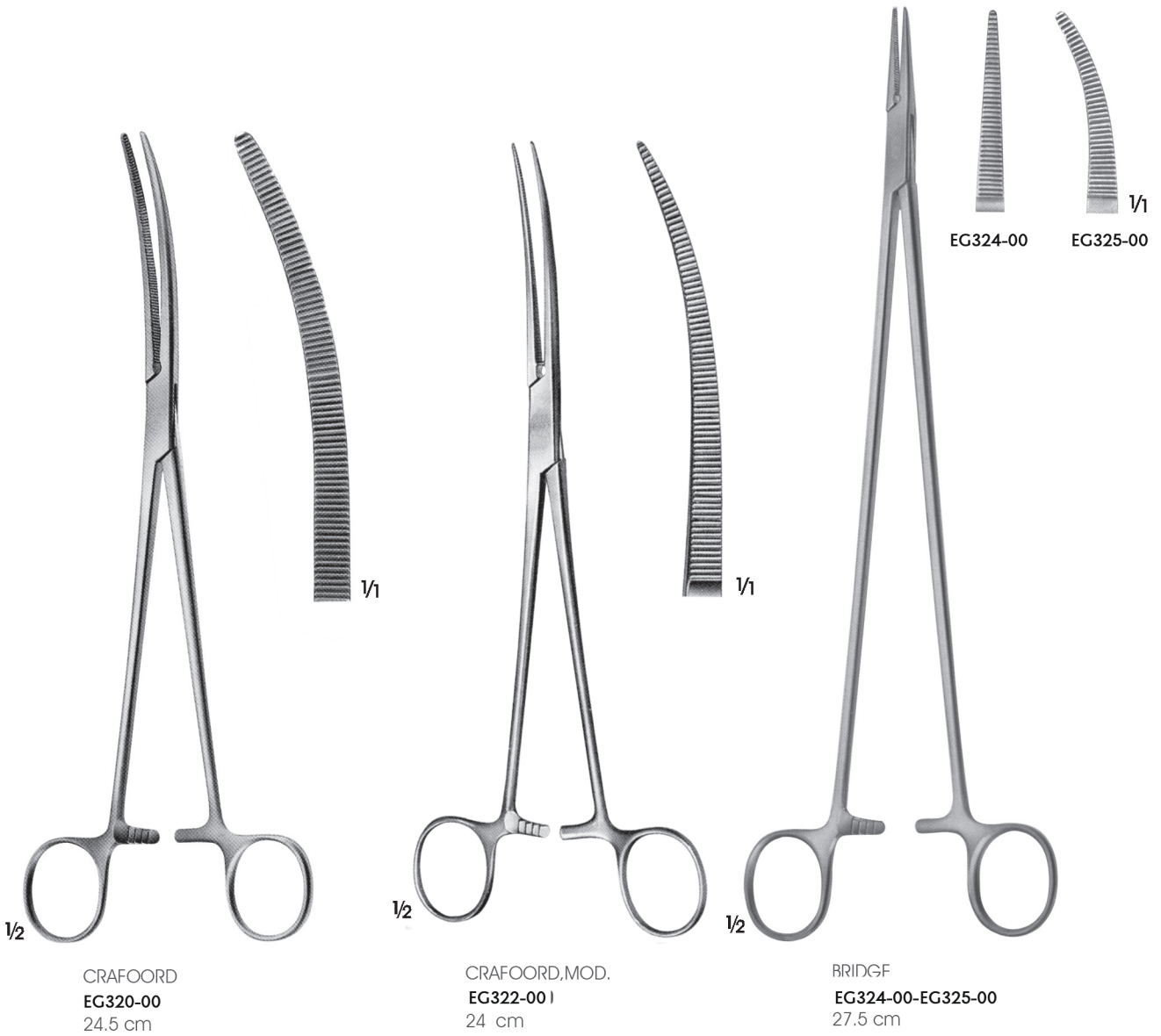

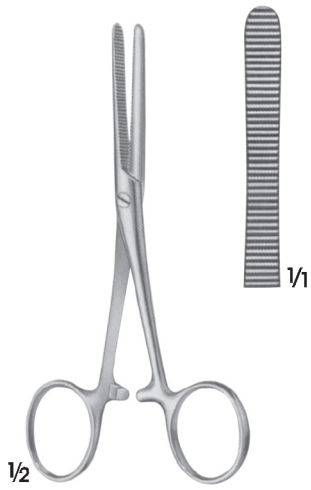

PEAN  
EG400-00  
12.5 cm



KRÖNLEIN  
EG401-00  
13 cm

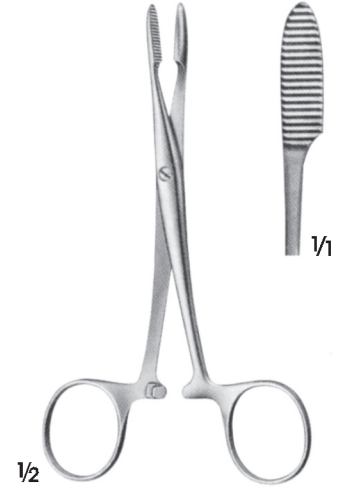

PEAN  
EG402-00  
12.5 cm



PEAN  
EG404-00-EG404-01

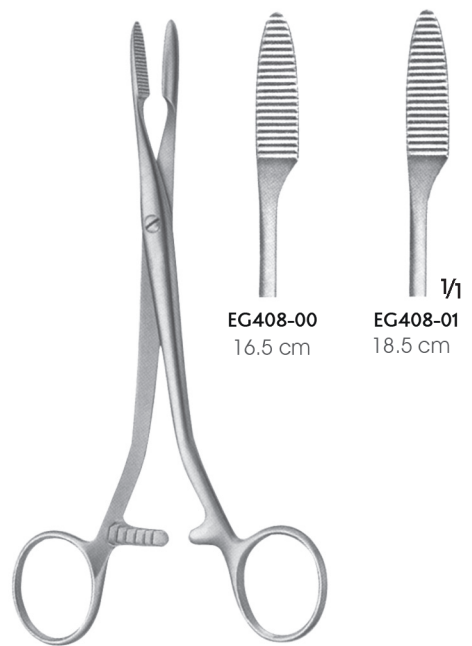

PEAN  
EG408-00-EG408-01



PEAN  
EG420-00-EG421-01  
Ince model/Slender type

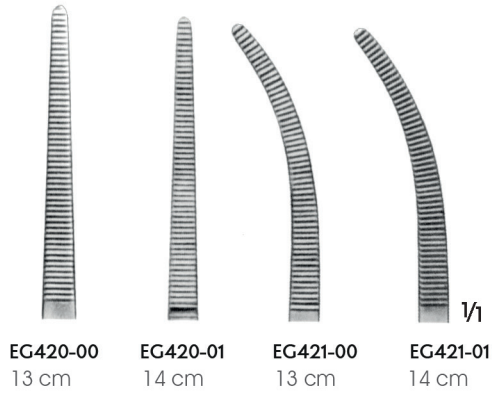

PEAN  
EG423-00-EG424-00

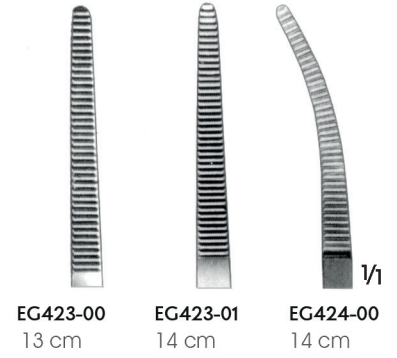

SPENCER - WELLS  
EG427-00-EG428-04

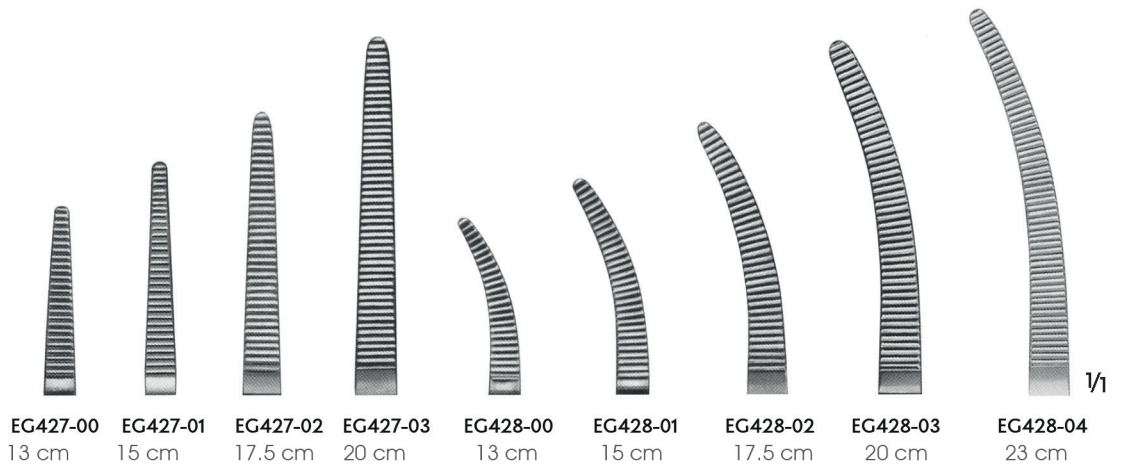

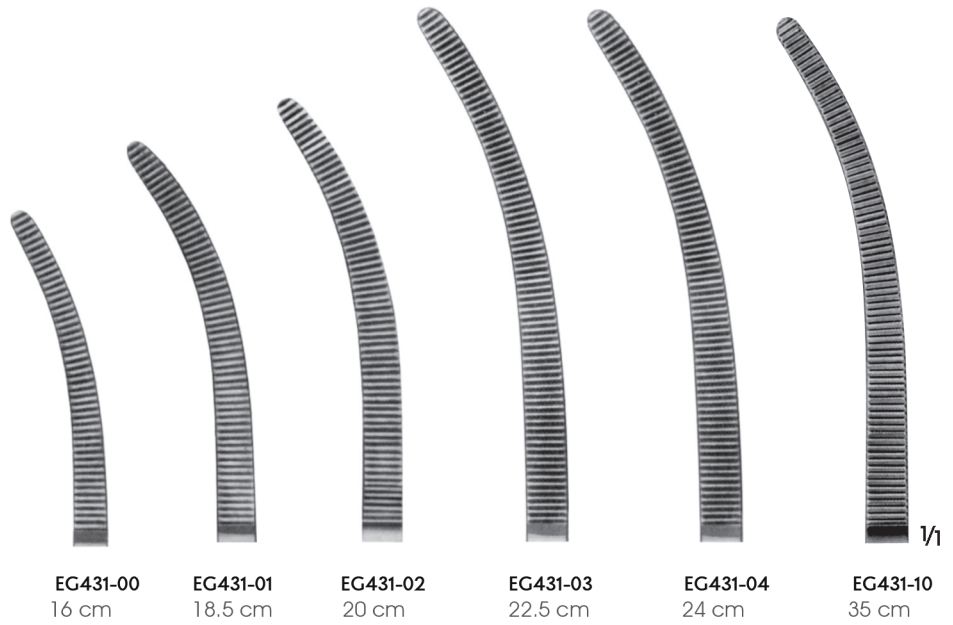
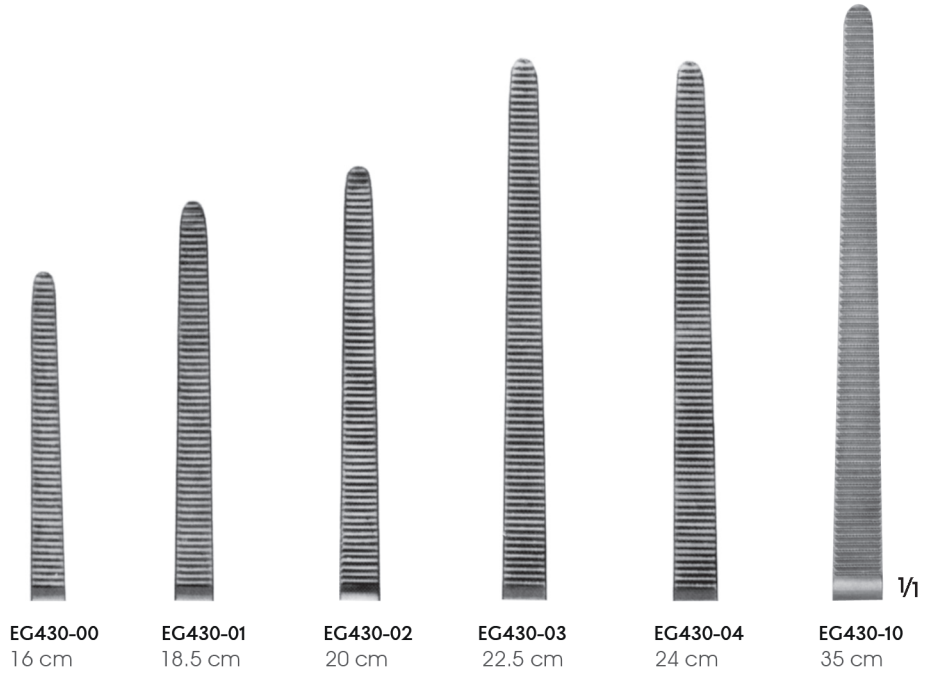

ROCHESTER - PEAN  
EG430-00-EG431-10



PEAN  
EG434-00-EG435-02

EG434-00  
24 cm

EG434-01  
26 cm

EG434-02  
28 cm

EG435-00  
24 cm

EG435-01  
26 cm

EG435-02  
28 cm





KOCHER  
EG437-00  
Güçlü model/Strong pattern  
14,5 cm

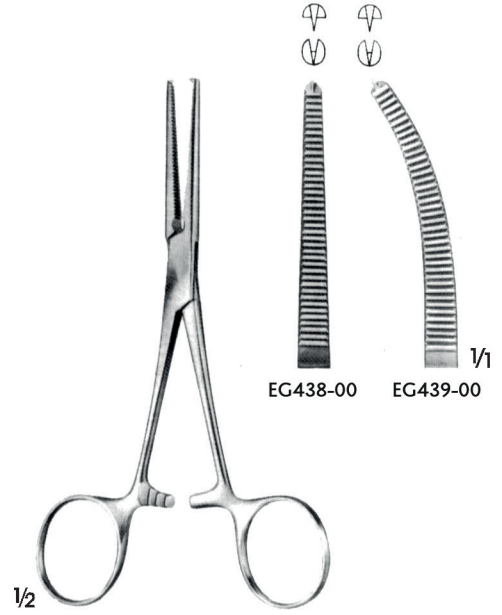

ROCHESTER-OCHSNER  
EG438-00-EG439-00  
14 cm

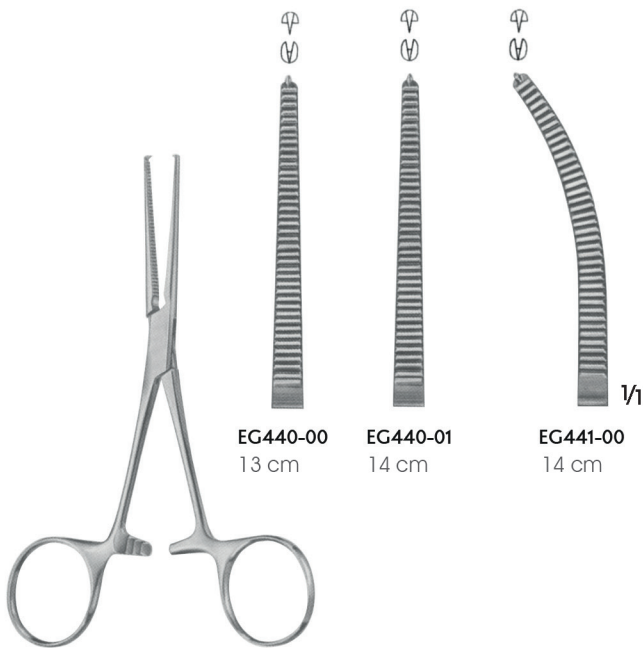

KOCHER  
EG440-00-EG441-00

EG440-00  
13 cm

EG440-01  
14 cm

EG441-00  
14 cm



KOCHER  
EG444-00-EG445-00  
15 cm

EG444-00

EG445-00



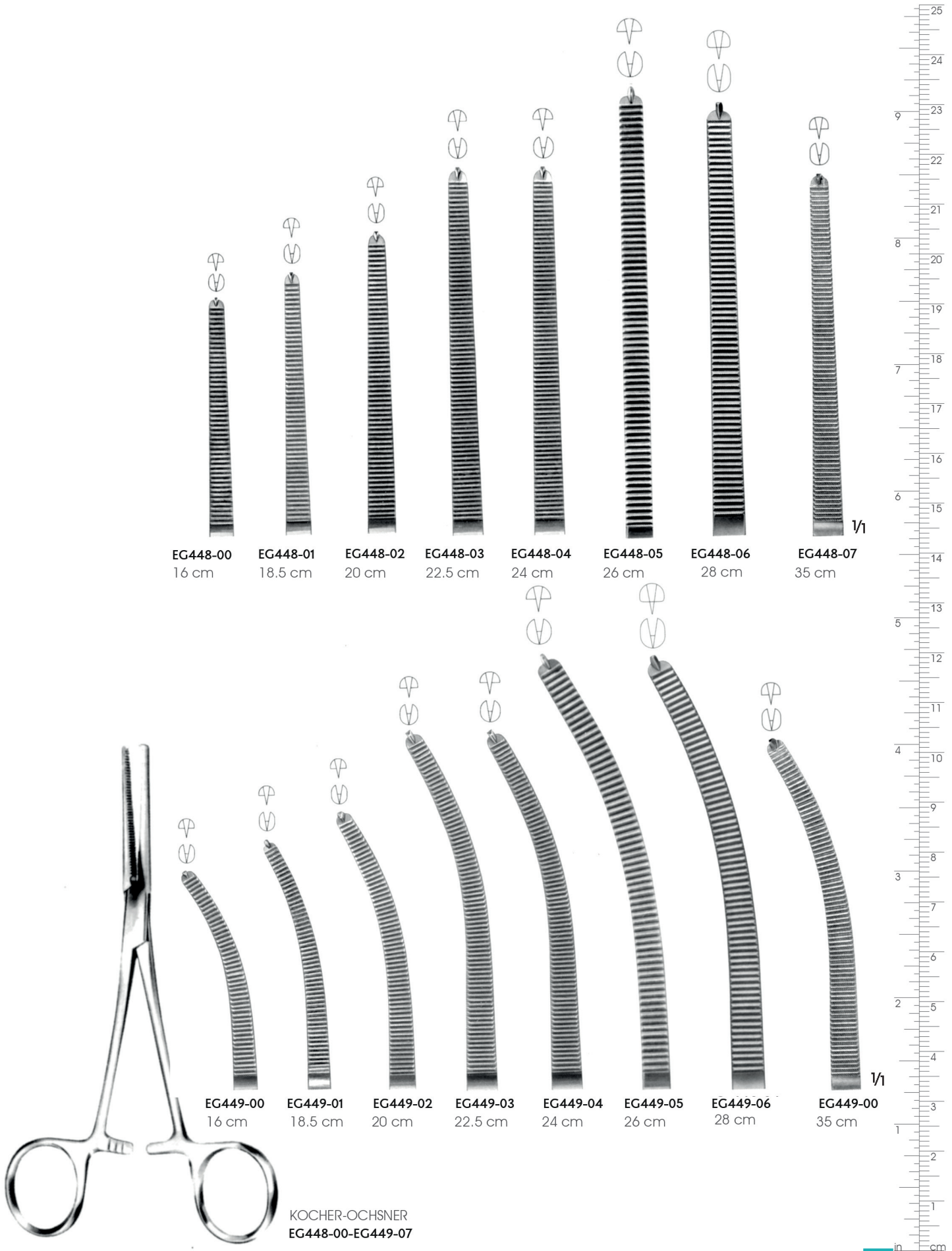

EG448-00  
16 cm

EG448-01  
18.5 cm

EG448-02  
20 cm

EG448-03  
22.5 cm

EG448-04  
24 cm

EG448-05  
26 cm

EG448-06  
28 cm

EG448-07  
35 cm

EG449-00  
16 cm

EG449-01  
18.5 cm

EG449-02  
20 cm

EG449-03  
22.5 cm

EG449-04  
24 cm

EG449-05  
26 cm

EG449-06  
28 cm

EG449-07  
35 cm

KOCHER-OCHSNER  
EG448-00-EG449-07

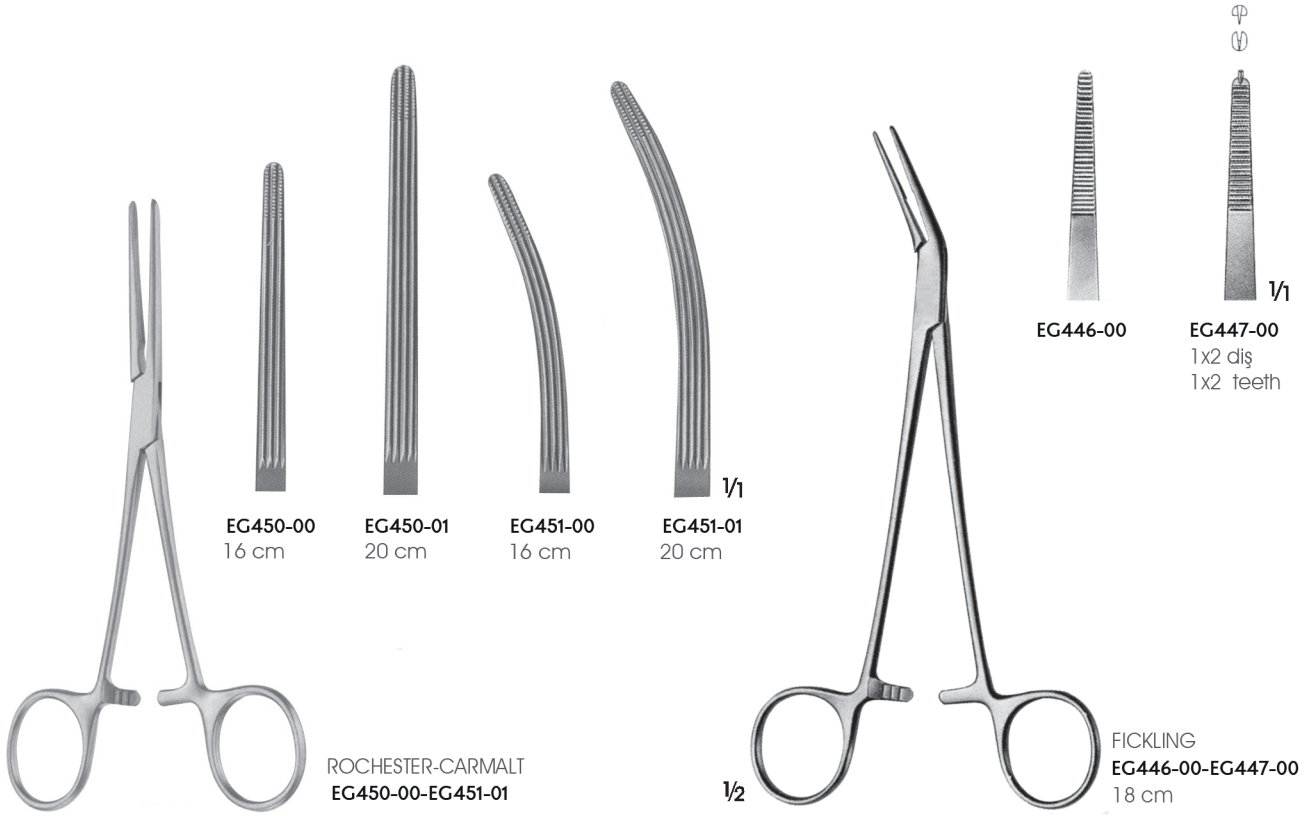



ROBERTS  
EG306-00  
22.5 cm



SAROT  
EG307-00  
25 cm



PEAN  
EG459-00-EG459-02



EG459-00  
19.5 cm



EG459-01  
22 cm



EG459-02  
23 cm



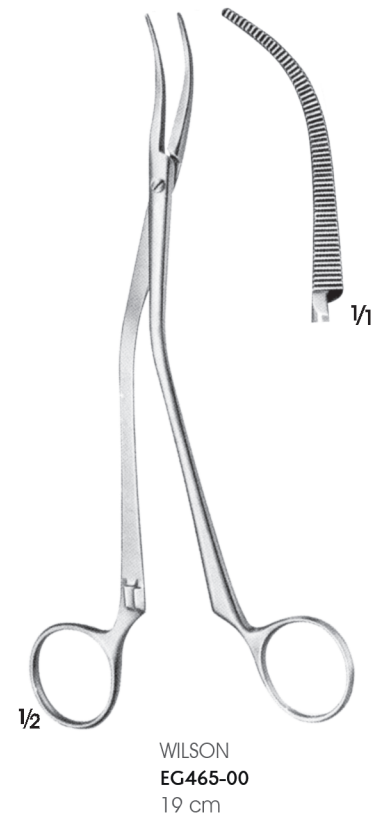
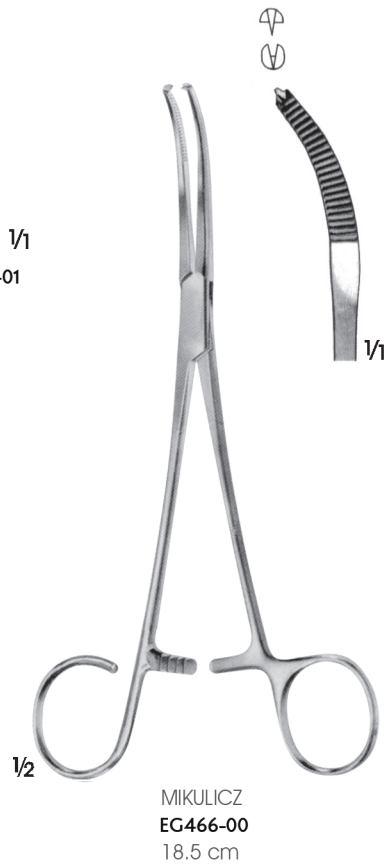
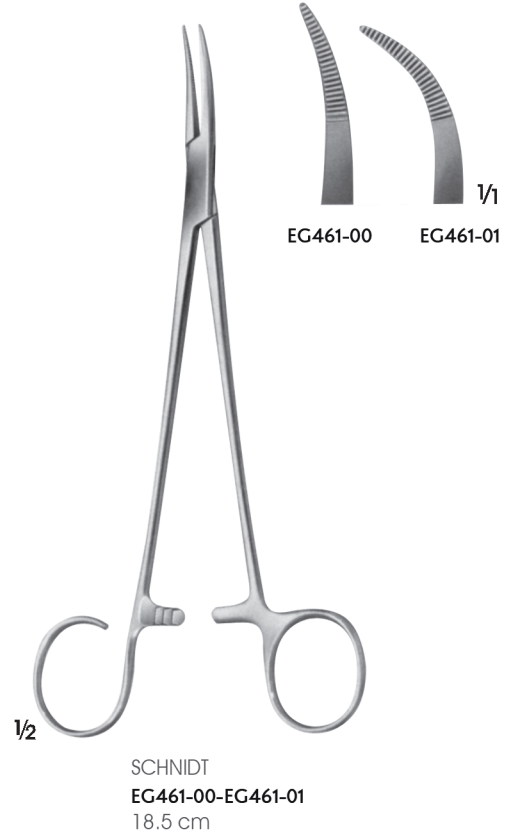

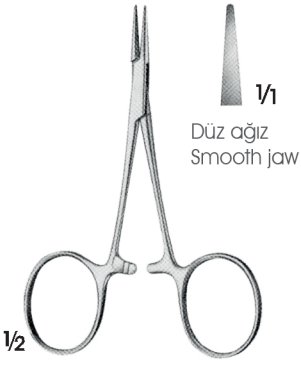

Düz ağız  
Smooth jaw

**EG610-00**  
Ligatür pens, düz  
Ligature forcep, straight  
9.5 cm



**MICRO-ADSON**  
**EG614-00**  
Diseksiyon pens  
Dissecting forcep  
14 cm

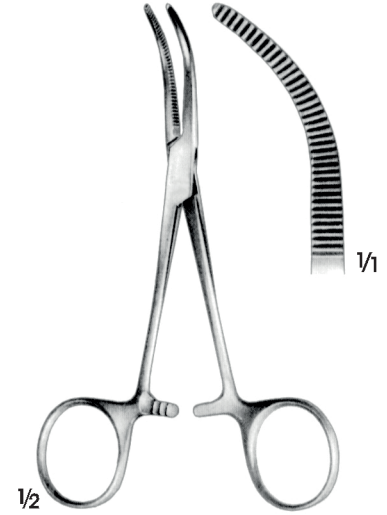

**BABY-OVERHOLT**  
**EG615-00**  
Diseksiyon pens  
Dissecting forcep  
13.5 cm



**EG616-00**  
14 cm

**EG616-01**  
18 cm

**BABY-MIXTER**  
**EG616-00-EG616-01**  
Diseksiyon pensleri  
Dissecting forceps

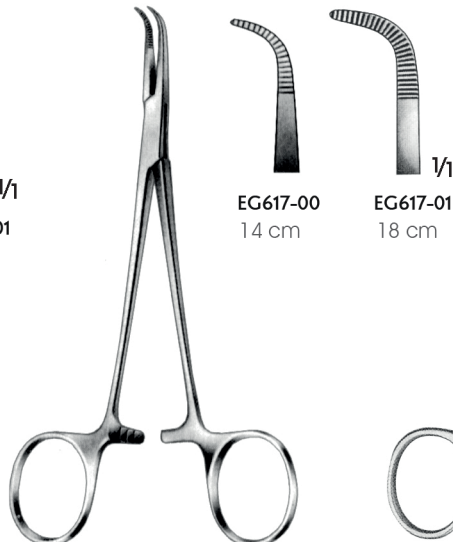

**EG617-00**  
14 cm

**EG617-01**  
18 cm

**BABY-ADSON**  
**EG617-00-EG617-01**  
Diseksiyon pensleri  
Dissecting forceps



**EG621-00**  
14 cm

**EG621-01**  
18 cm

**EG621-00-EG621-01**  
Diseksiyon pensleri  
Dissecting forceps





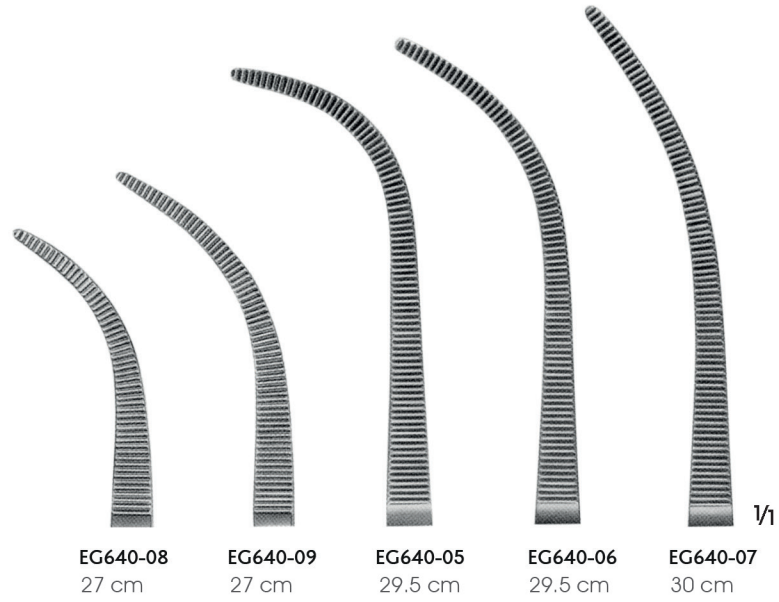
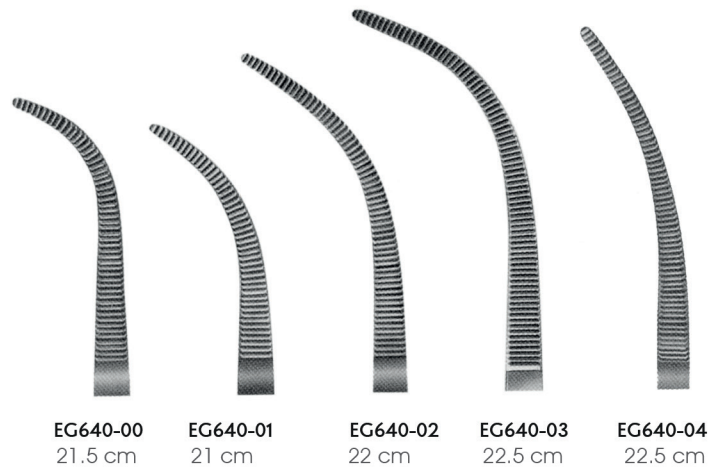

OVERHOLT  
EG640-00-EG640-07  
Hassas model/Delicate pattern



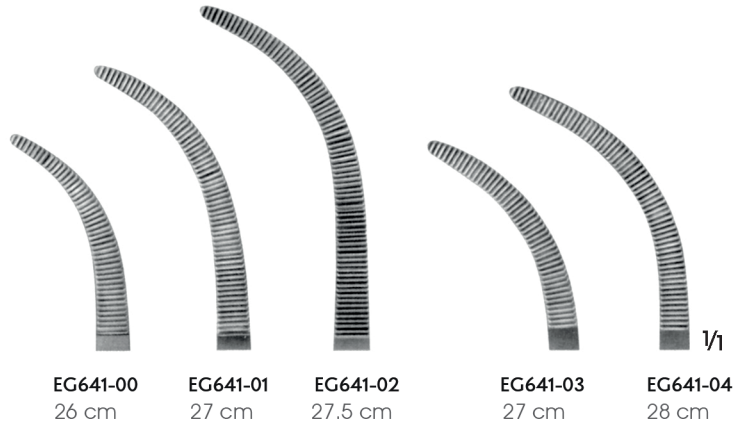
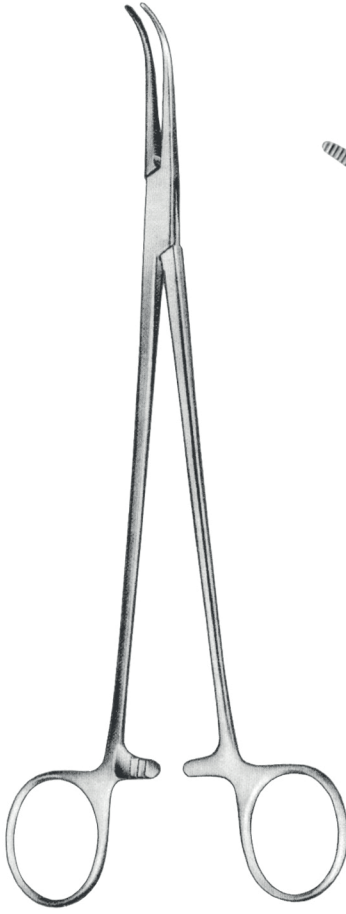

OVERHOLT-GEISSENDOERFER  
EG641-00-EG641-04

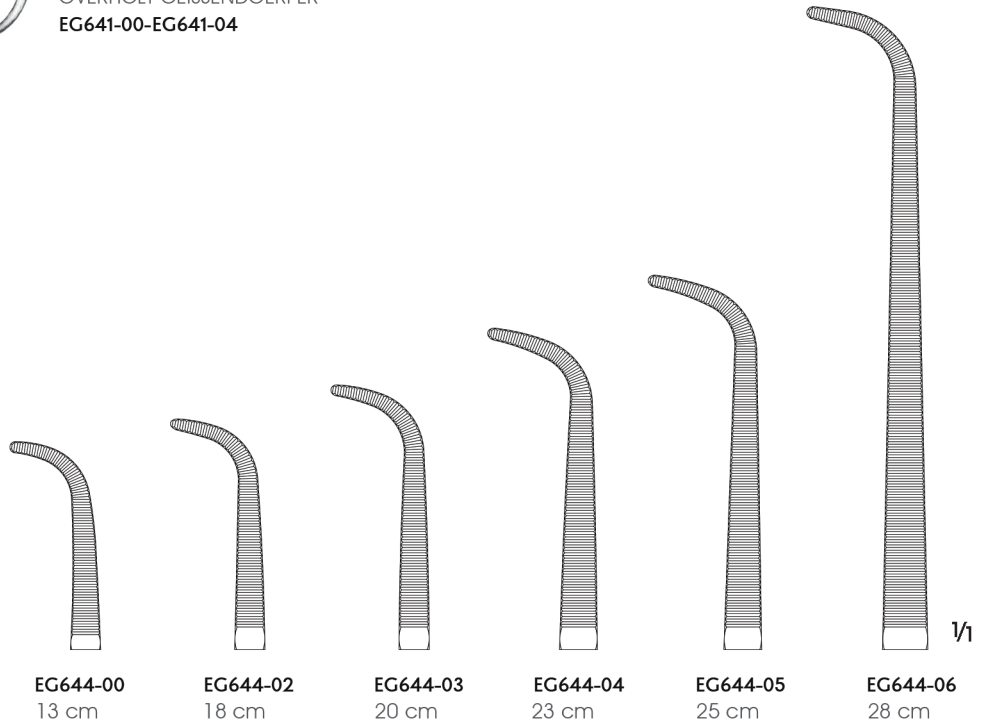

GEMINI  
EG644-00-EG644-06





EG652-00  
15 cm



EG652-01  
18 cm



EG652-02  
20 cm



EG652-04  
23 cm



EG652-05  
25.5 cm

1/1



O'SHAUGHNESSY  
EG652-00-EG652-05

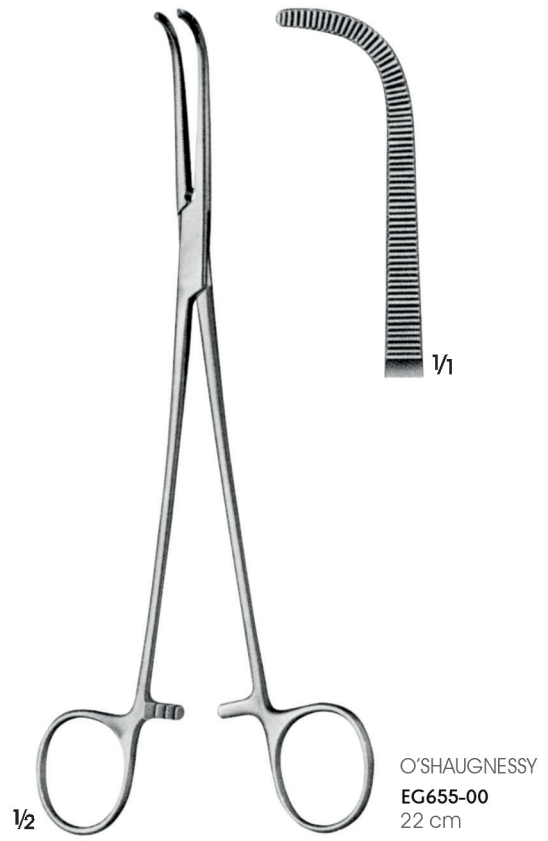
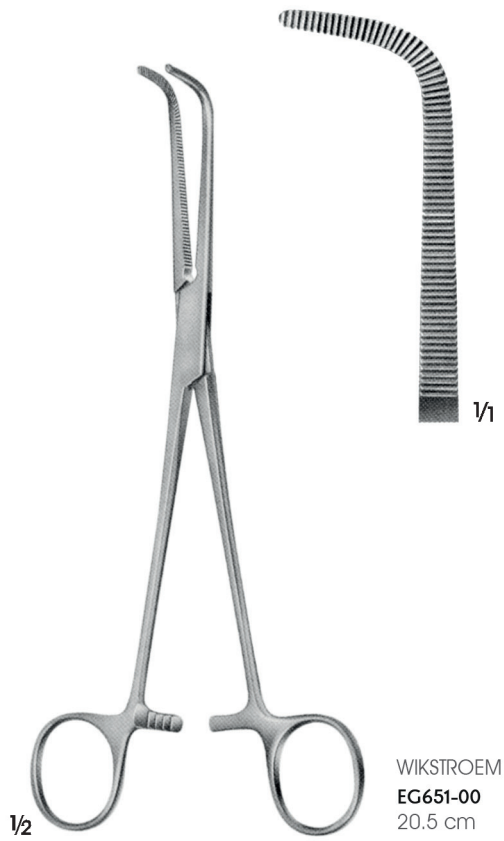
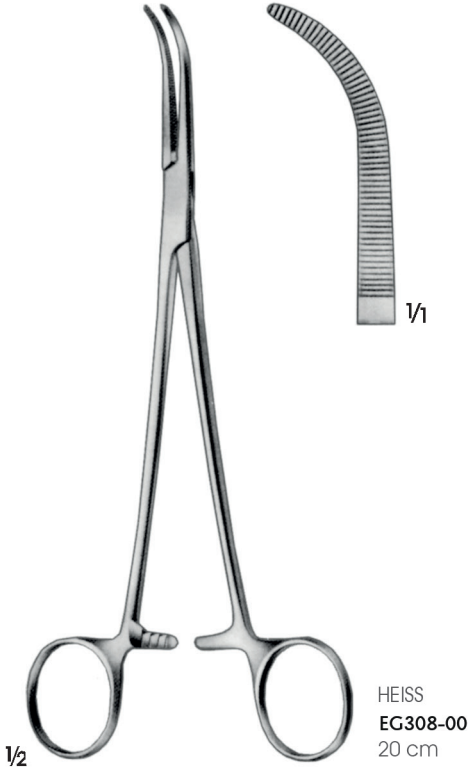



EG656-00  
20 cm

KANTROWITZ  
EG656-00-EG656-02



EG656-01  
24 cm



EG656-02  
27.5 cm



EG657-00  
Çok hassas  
Extra delicate

BARRE  
EG657-00-EG657-05  
28 cm



EG657-05  
Hassas  
Delicate



EG658-00

RUMEL  
EG658-00-EG658-04  
24 cm



EG658-01



EG658-02



EG658-03



EG658-04





ZENKER  
EG669-00-EG669-07

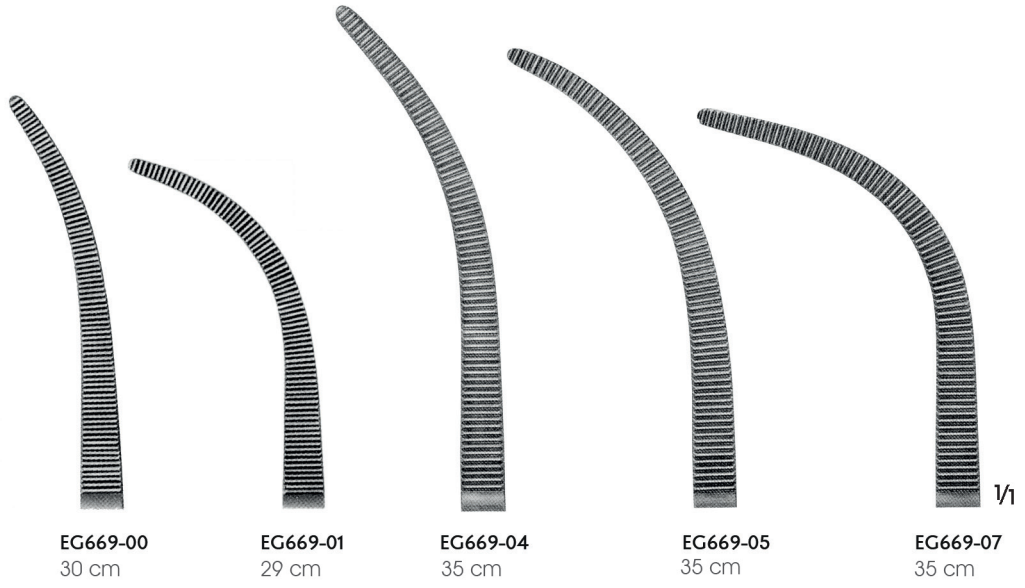



MIXTER  
EG654-00  
23 cm



LAWRENCE  
EG664-00  
27 cm



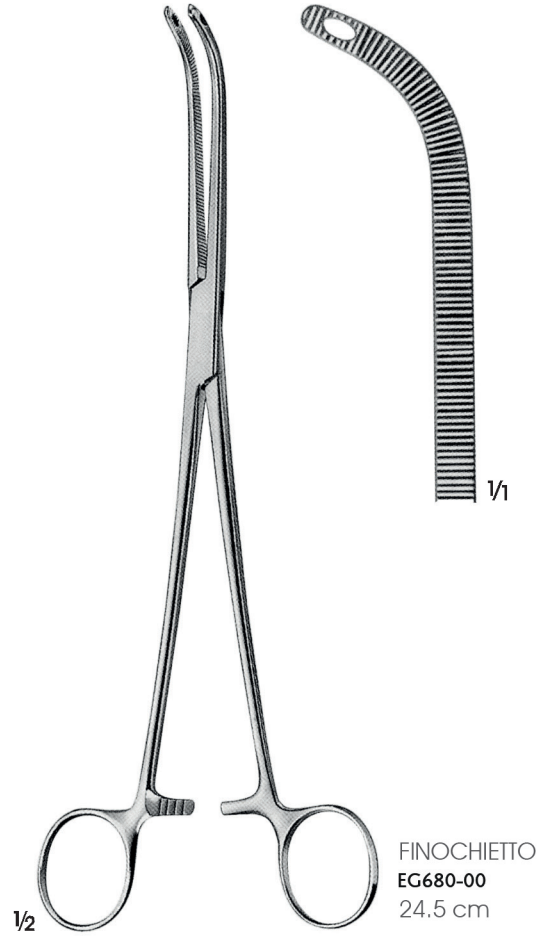
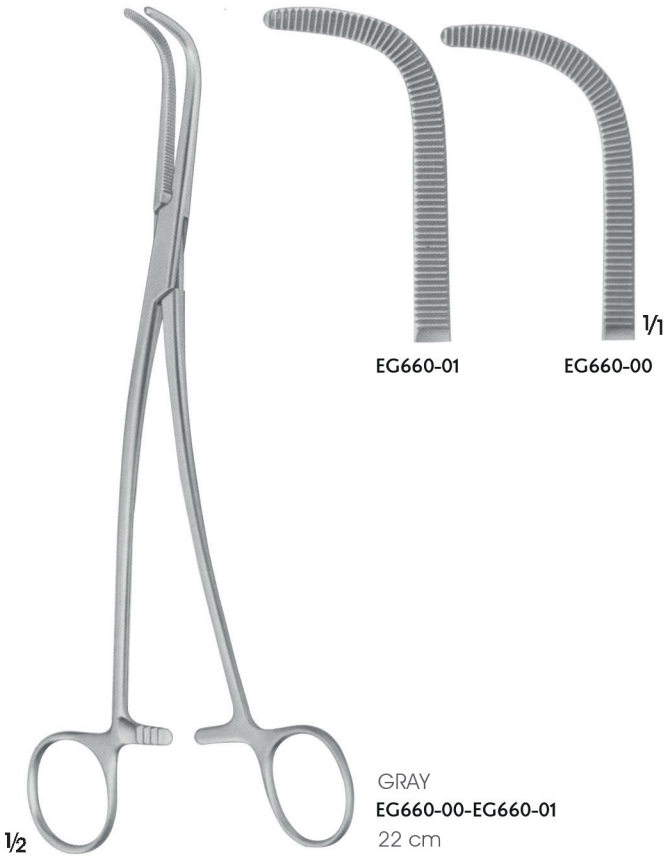
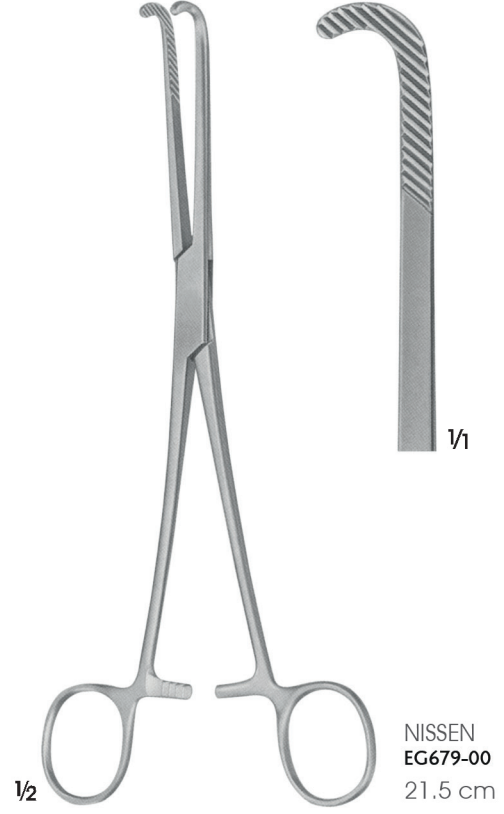
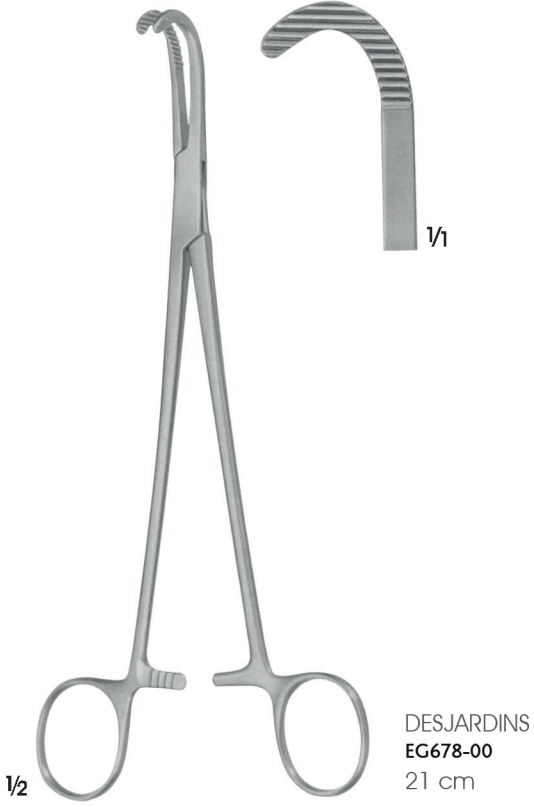

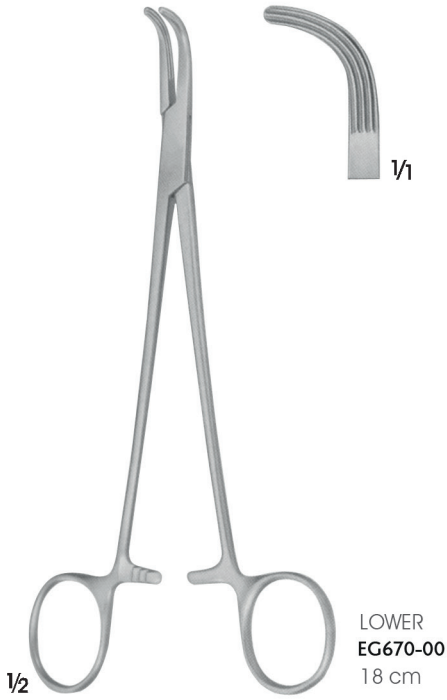
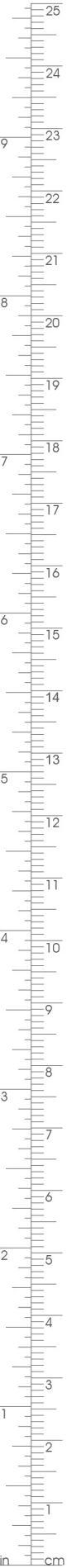

LOWER  
EG670-00  
18 cm



EG675-00  
23.5 cm

EG675-02  
35 cm

KEIBACK  
EG675-00-EG675-02  
Öne eğimli üreter kanalı  
açma klempleri  
Ureteral tunnel clamps  
curved on flat



LAHEY (SWEET)  
EG672-00  
20 cm

LAHEY  
EG672-01  
22.5 cm

LAHEY (SWEET)  
EG672-04  
23 cm

LAHEY  
EG672-00-EG672-04



EG674-00  
22 cm

EG674-01  
25 cm

EG674-03  
29 cm

MIXTER  
EG674-00-EG674-03



**BABY-MIKULICZ**  
**EG690-00**  
14 cm



**MIKULICZ**  
**EG691-00**  
18.5 cm

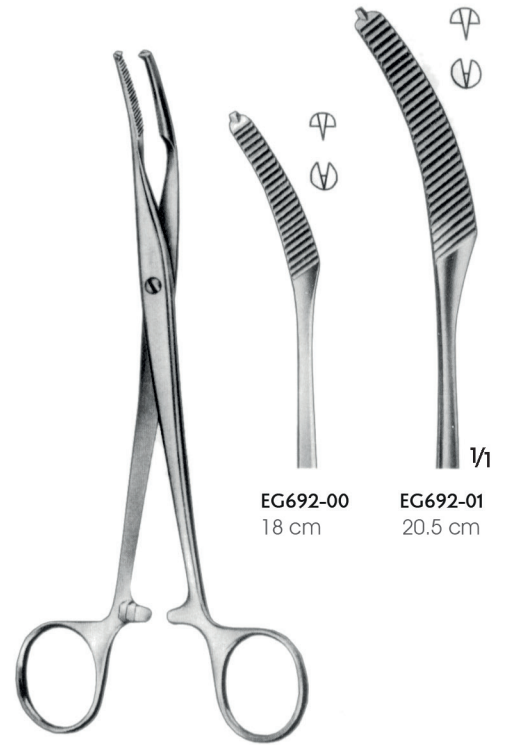

**MIKULICZ**  
**EG692-00-EG692-01**

**EG692-00**  
18 cm

**EG692-01**  
20.5 cm



**MIKULICZ**  
**EG693-00**  
20.5 cm



**MIKULICZ**  
**EG694-00**  
20.5 cm



**MIKULICZ**  
**EG695-00**  
20 cm



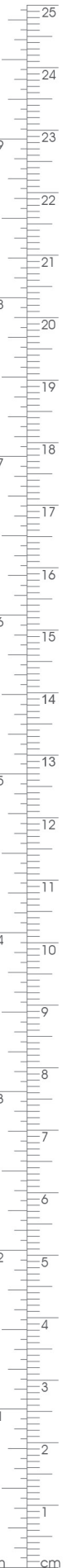
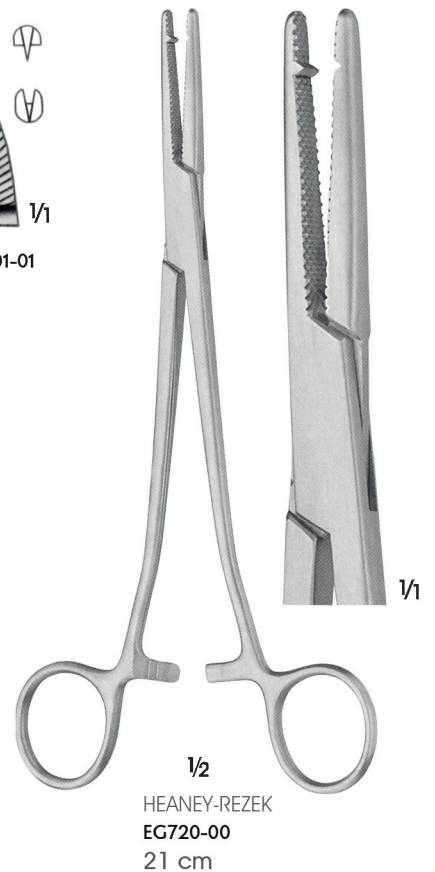
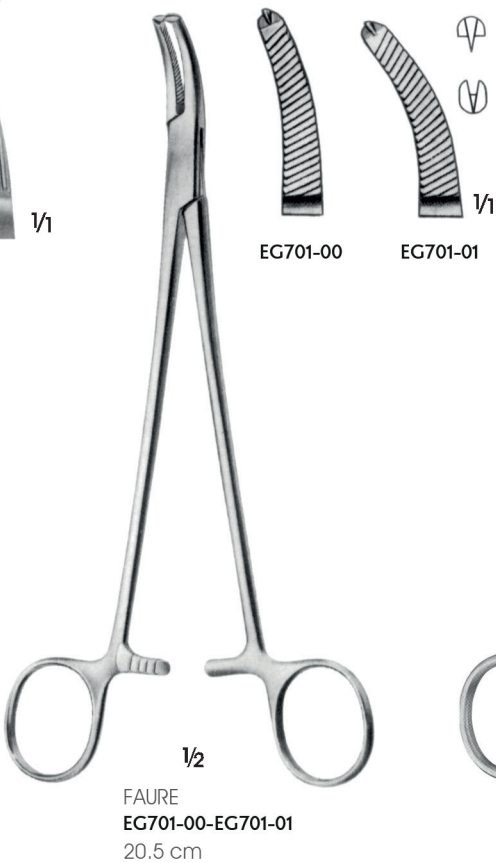

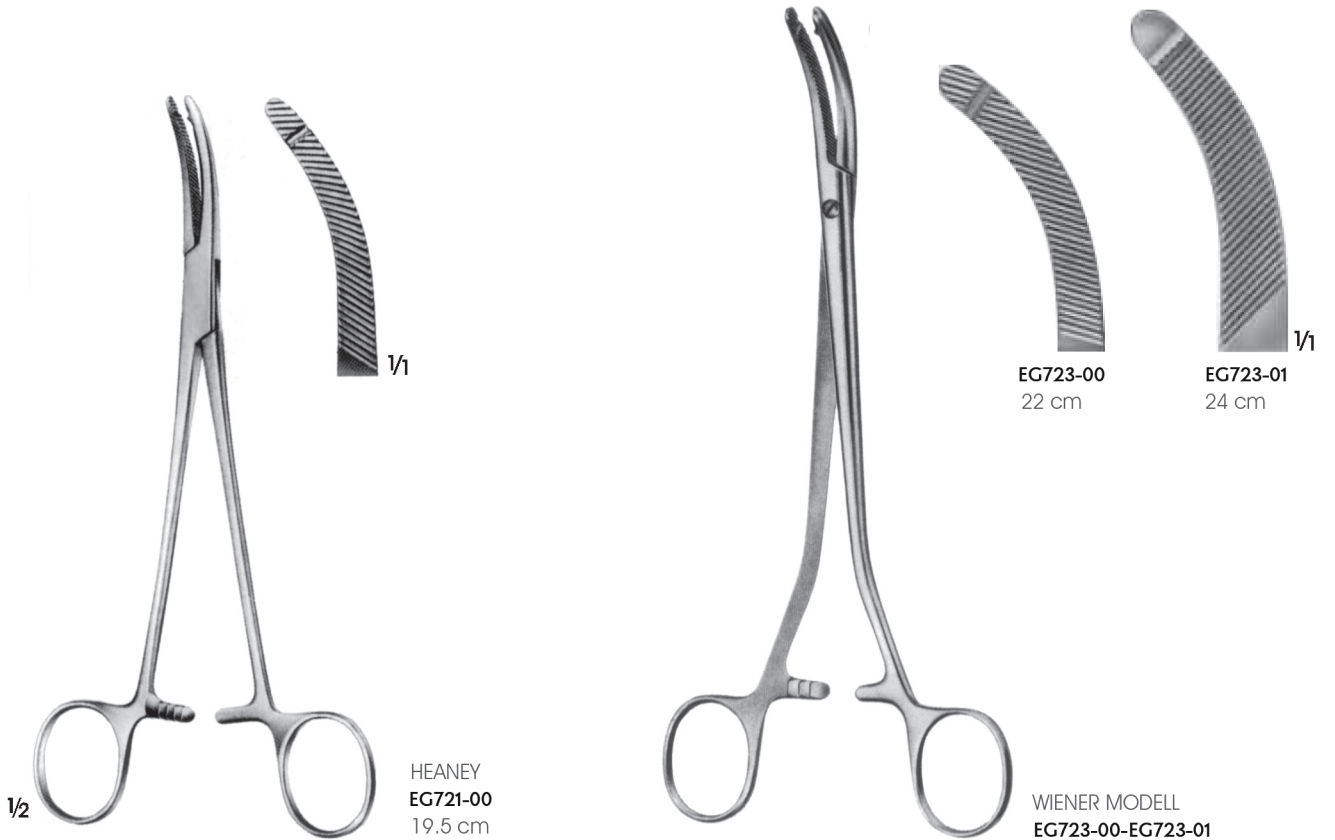

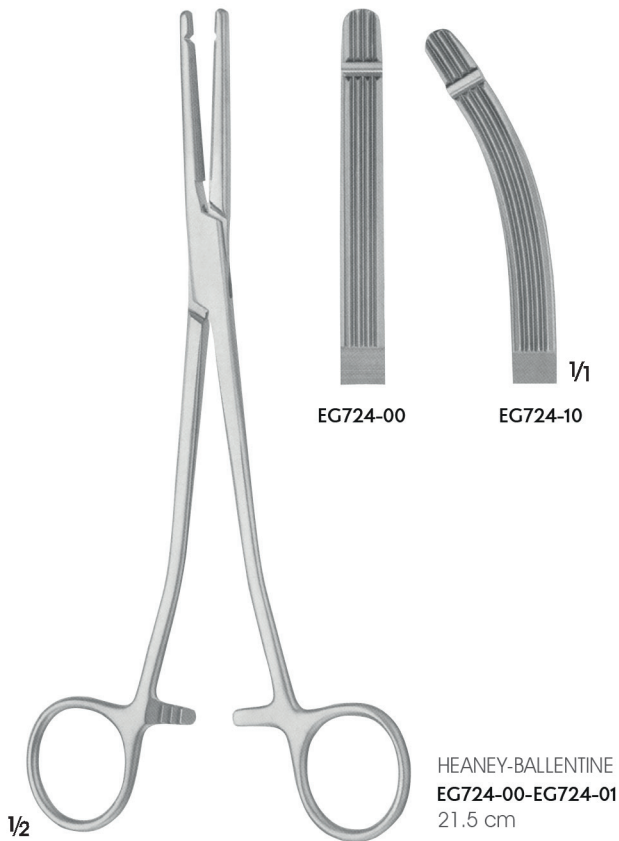
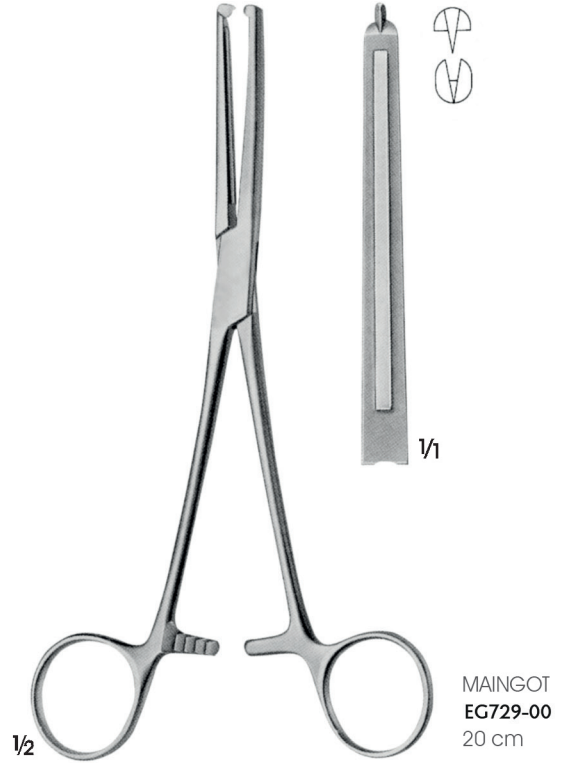

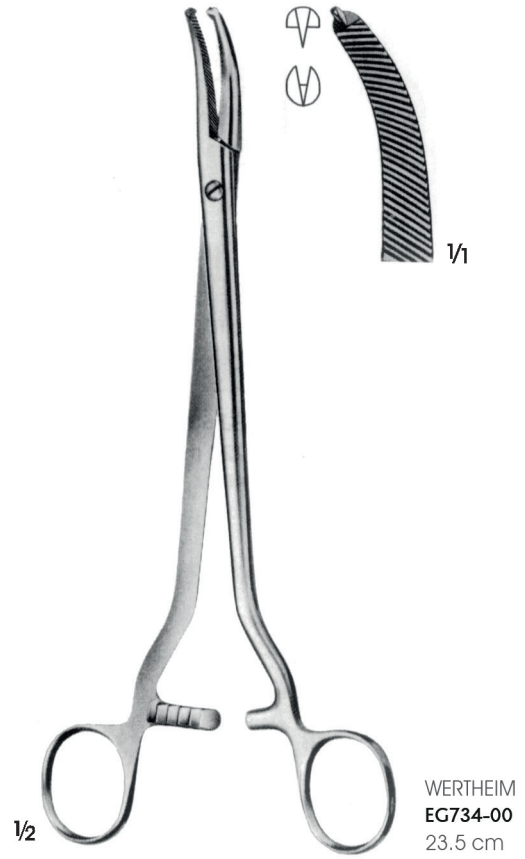
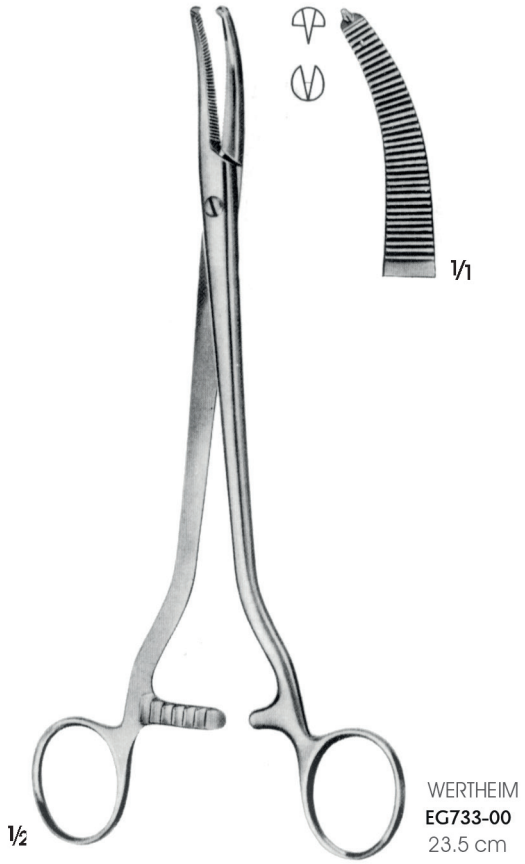

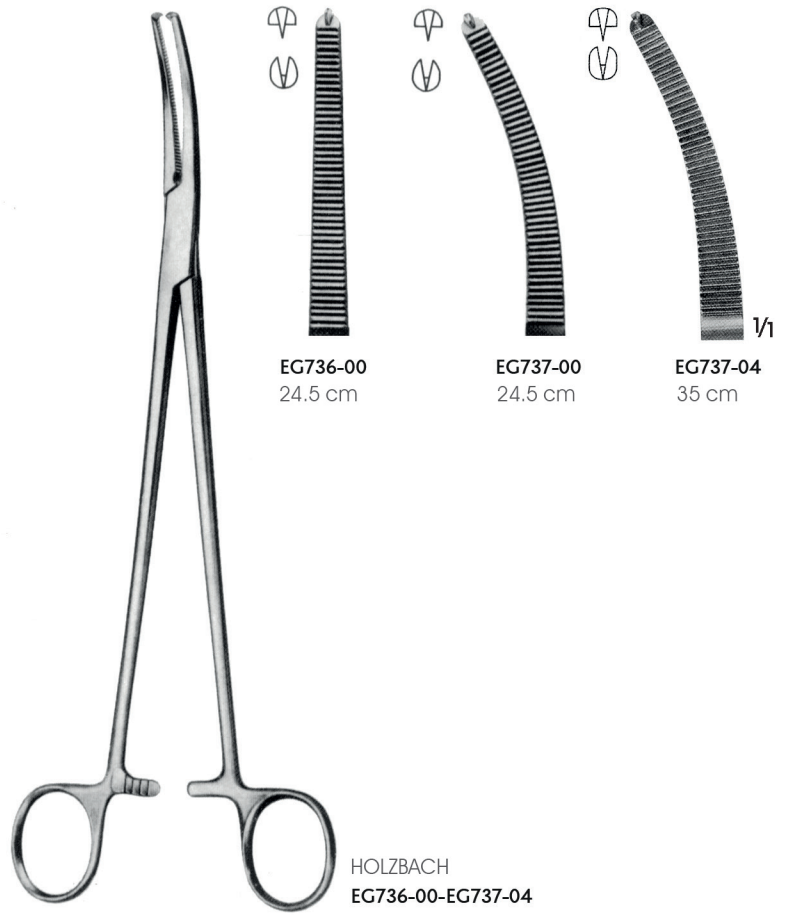
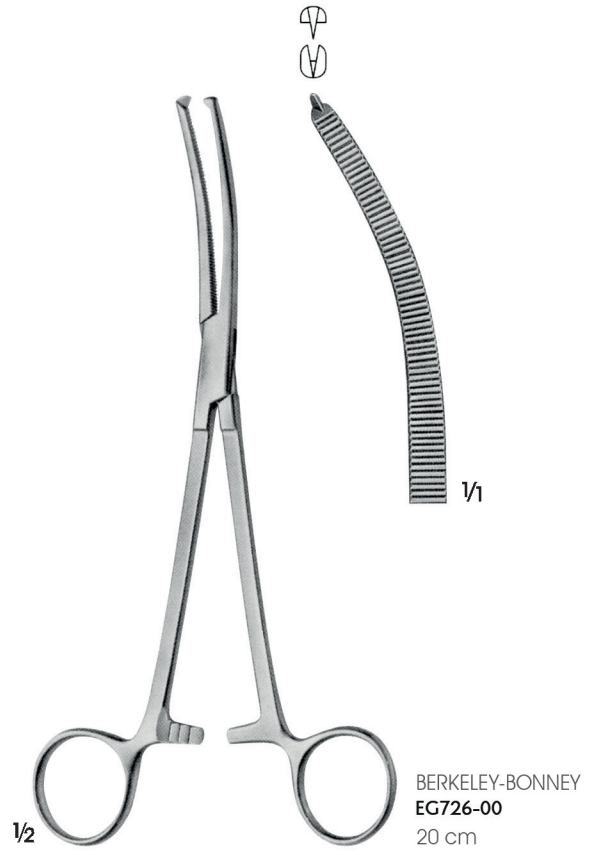
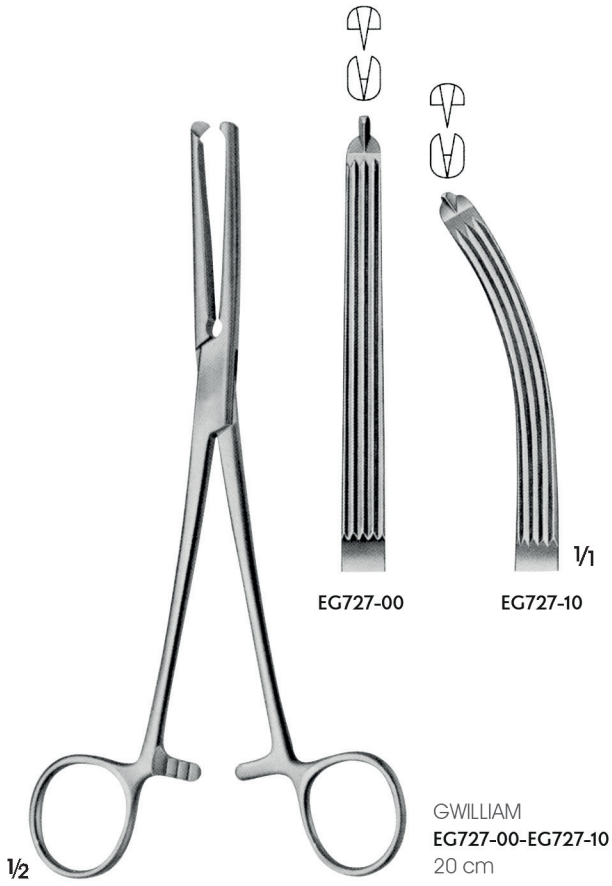



De Bakey Diş



Toothing De BAkey



EG750-00  
22.5 cm



EG751-00  
22 cm



EG752-00  
21.5 cm



EG753-00  
20.5 cm

HEANEY  
EG750-00-EG753-00



EG754-00  
25 cm



EG755-00  
24.5 cm



EG756-00  
24 cm



EG757-00  
22 cm

WERTHEIM  
EG754-00-EG757-00

De Bakey Diş



Toothing De BAkey

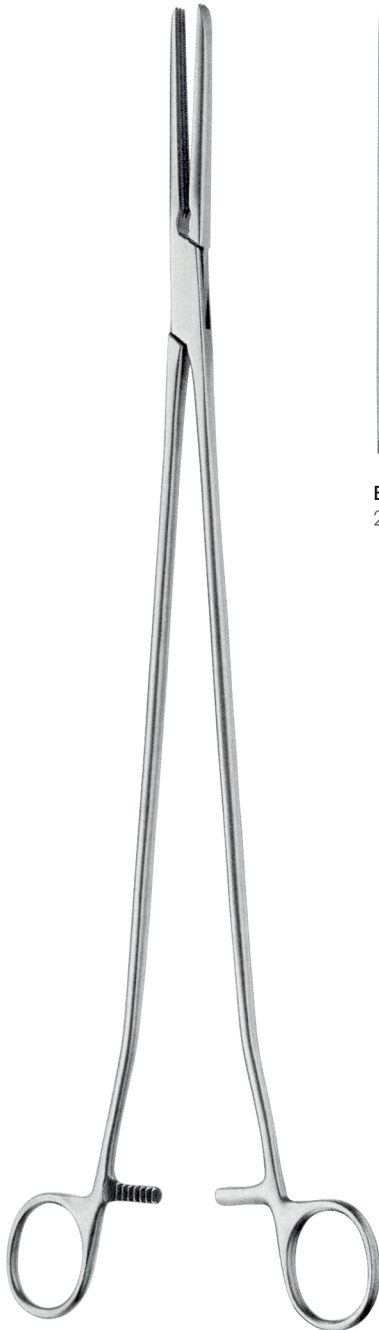

**EG758-00**  
25 cm



**EG758-04**  
35 cm



**EG758-10**  
25 cm



**EG758-11**  
35 cm

KIEBACK

EG758-00-EG758-04  
EG758-10-EG758-11





WERTHEIM  
EG760-00  
25.5 cm



WERTHEIM  
EG766-00  
26 cm





BURKE

**EG775-00-EG775-02**

Parametrium pensi kısa ağız

Parametrium clamp, short jaw part



BURKE

**EG776-00-EG776-02**

Parametrium pensi uzun ağız

Parametrium clamp, long jaw part





De Bakey Diş



Toothing De BAkey





EH204-00-EH204-01  
23 cm



WERTHEIM-CULLEN  
EG771-00  
21.5 cm



