

EF

Portegüler ve Sütur Aletleri
Needle Holders and Suture Instruments

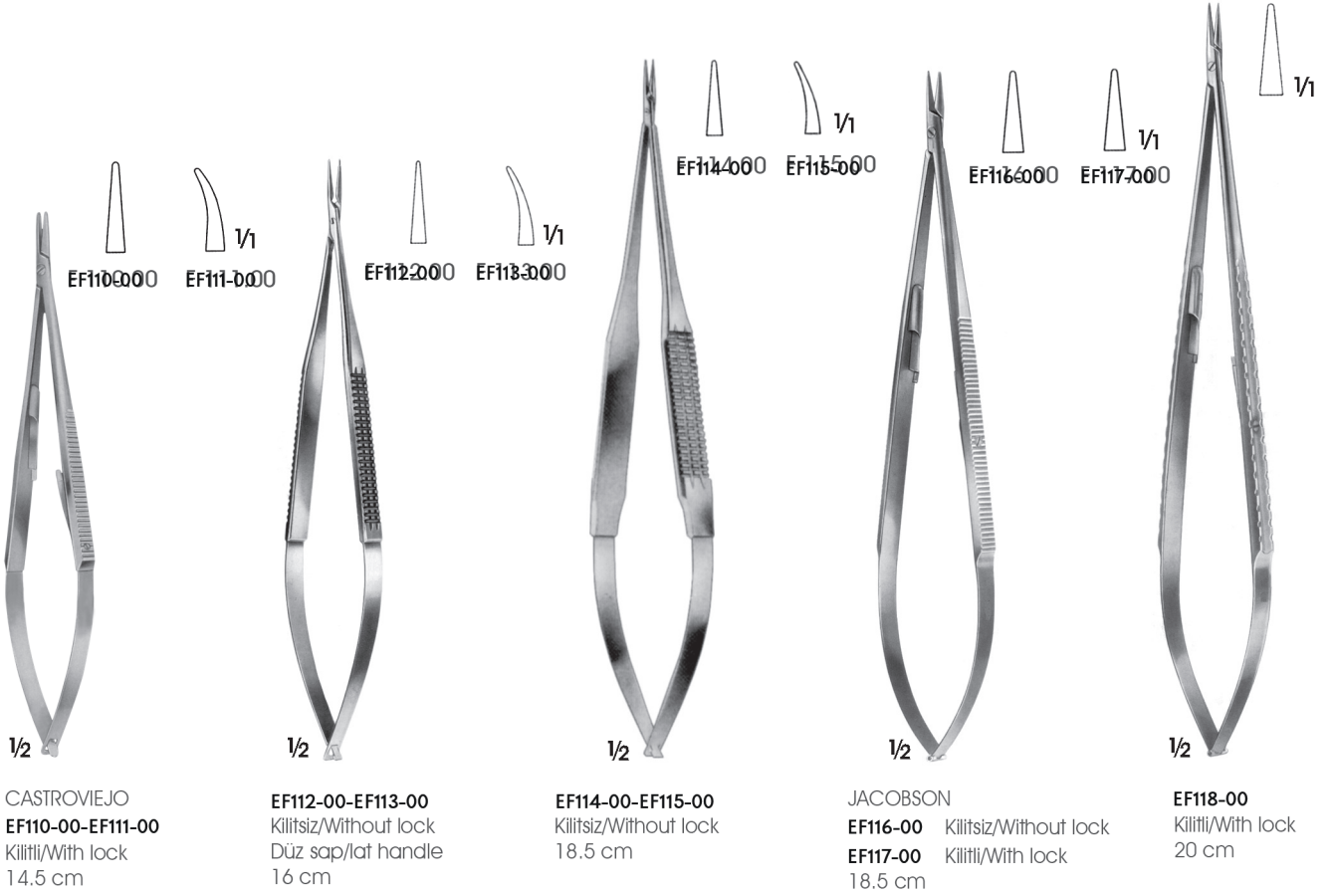

Düz Saplar/Flat Handles



Ergonomik, hafif plastik sap
yorulmadan optimum kullanım
sağlar.

Ergonomic, light weight plastic
handle provides fatigue free,
optimal usage.

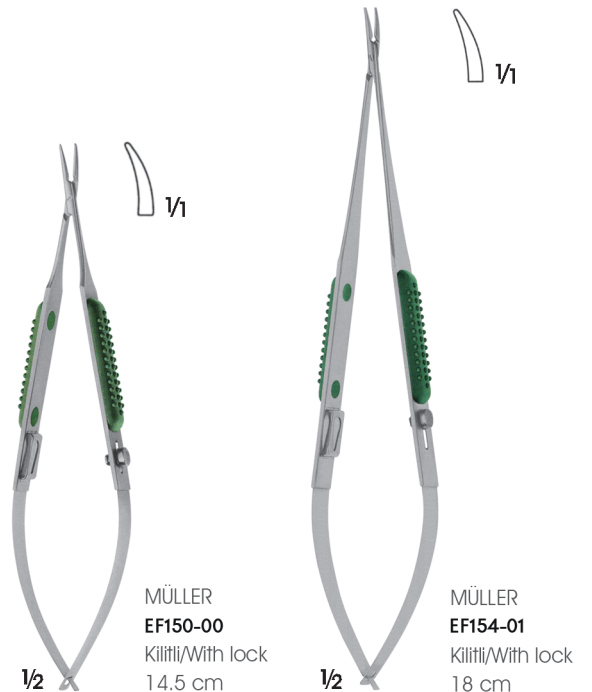

Yuvarlak Saplar

Parmaklar arasında istenildiği şekilde döndürmeye izin verir.

Sağlam veya oyulmuş saplardan dolayı her bir alette optimum denge sağlar

Round Handle

Allows rotation between the fingers as required

Due to carved and strong handle, each instrument provides optimum balance

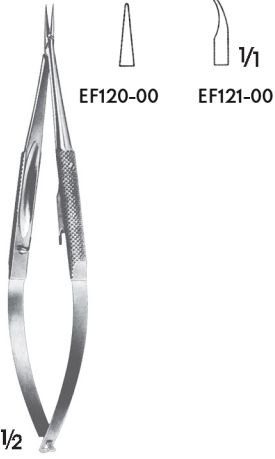

BARRAQLIFER
EF120-00-EF121-00
Kilitli/With lock
12 cm

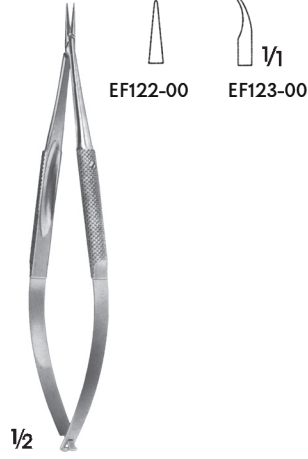

BARRAQLIFER
EF122-00-EF123-00
Kilitsiz/Without lock
12 cm



BARRAQLIFER
EF130-00-EF131-00
Kilitsiz/Without lock



EF124-00-EF125-00
Kilitli/With lock
15 cm

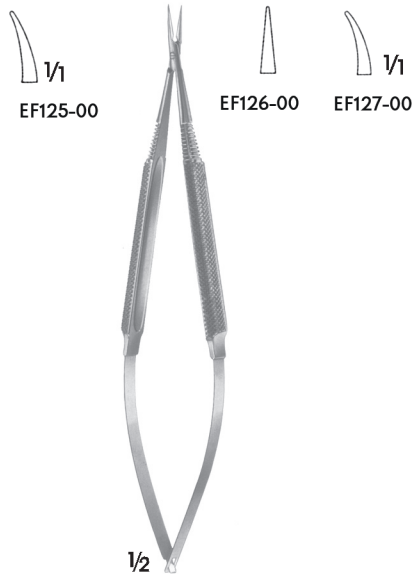

RF III
EF126-00-EF127-00
Kilitsiz/Without lock
15 cm



EF132-00-EF133-00
Kilitsiz/Without lock
18.5 cm



EF134-00-EF135-00
Kilitli/ With catch
18.5 cm



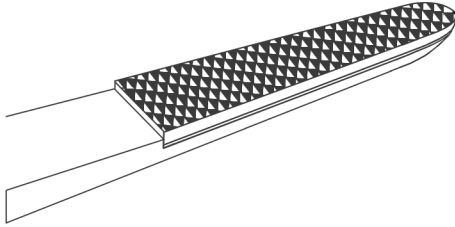

Elmas Uclu Portegüler :

Bahadır Portegülerinin ağızlarındaki elmas uclarının kullanıma göre yüzey yapısı seçilebilir.

Bahadır elmas uclu portegülerinin 4 farklı yüzeyi vardır. Pürüzsüz yüzey ve 3 farklı çentik yüzeyi uygun iğne yakalamayı sağlar.

Needle holders with carbide inserts.

The carbide inserts on BAHADIR needle holders can be selected based on usage.

BAHADIR needle holders with carbide inserts have four different surface types. Smooth surface and three different notched surfaces provide appropriate needle catch.



Düz
smooth

Pürüzsüz yüzeye sahip ağızlarda kullanılacak, dikiş malzemesi için: 9/0 - 11/0

With smooth jaw surface for suture materials: 9/0 - 11/0



0,2

0.2 mm adımlı çentiğe sahip ağızda kullanılacak, dikiş malzemesi için: 6/0 - 10/0

With 0.2 mm pitch of serration for suture material: 6/0 - 10/0



0,4

0.4 mm adımlı çentiğe sahip ağızda kullanılacak, dikiş malzemesi için: 4/0 - 6/0

0.4 mm pitch of serration for suture material: 4/0 - 6/0



0,5

0.5 mm adımlı çentiğe sahip ağızda kullanılacak, dikiş malzemesi için: 3/0' a kadar

0.5 mm pitch of serration for suture material: up to 3/0



1/2

CASTROVIEJO
EF301-00
Kilitli/With lock
14.5 cm

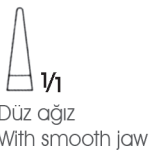

1/2

CASTROVIEJO
EF303-00
Kilitli/With lock
14.5 cm



0,2



1/2

EF312-00
Kilitli/With lock
17 cm



0,4



CASTROVIEJO
EF305-00-EF305-01
Kilitli/With lock



0,2

EF305-00
18 cm



0,2

EF305-01
21.5 cm



1/2

EF308-00
Kilitli/With lock
18 cm



0,2



1/2

EF308-01
Kilitli/With lock
20 cm

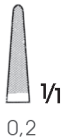

0,2

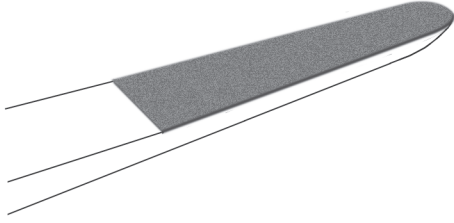

DIAMOTE ağızlar, daha sert ve aşınmaya dayanıklı yüzeyler sağlar.
DIAMOTE ağızlar, hassas iğne, suture ve dokuların güvenilir bir şekilde kavranmasını garanti eder.

DIAMOTE jaws provide harder and more wear resistant surfaces.
DIAMOTE jaws ensure reliable grip of fine needles, sutures and tissues.

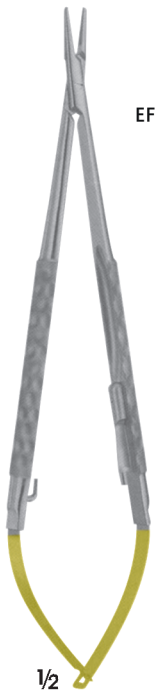

EF307-00

EF307-04

1/2

EF307-00-EF307-04
Kilitli/With lock
18 cm



1/1

Suture 5-0 ve daha
küçükler için
For sutures 5-0
and smaller

1/2

EF310-36
Kilitli/With lock
21 cm



1/1

Suture 5-0 ve daha
küçükler için
For sutures 5-0
and smaller

1/2

EF310-37
Kiltsiz/Without lock
21 cm



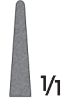

1/1

Sütür 5-0 ve daha
küçükler için
For sutures 5-0
and smaller

GLASSER
EF310-91
Kilitli/With lock
12.5 cm



1/1

Sütür 5-0 ve daha
küçükler için
For sutures 5-0
and smaller

GLASSER
EF310-92
Kilitli/With lock
18 cm



EF317-00
14 cm



EF317-01
16 cm



EF317-02
18 cm



EF317-04
22 cm



EF317-05
25 cm

1/1

RYDER
EF317-00-EF317-05
Sütür 5-0 ve daha
küçükler için
For sutures 5-0
and smaller

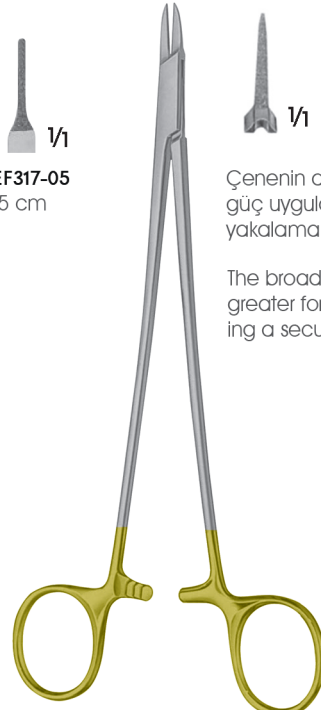

1/1

Çenenin arka bölümü iğneyle büyük
güç uygular, böylelikle güvenli
yakalama kolay hale gelir.

The broad back of the jaw exerts
greater force on the needle, facilitat-
ing a secure hold.

EF319-00
19.5 cm



Sütür 7-0 ve daha
küçükler için
For sutures 7-0
and smaller

18.5 cm **EF312-01T**
21 cm **EF312-02T**
23 cm **EF312-04T**
Kilitli/With lock

18.5 cm **EF311-01T**
21 cm **EF311-02T**
23 cm **EF311-04T**
Kilitsiz/Without lock

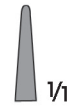
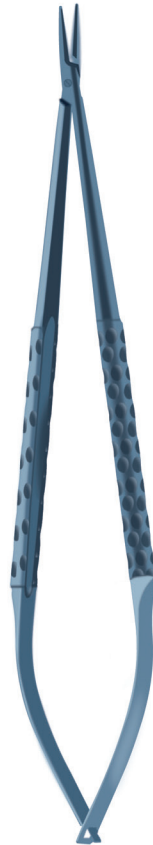

Sütür 5-0 ve daha
küçükler için
For sutures 5-0
and smaller

18.5 cm **EF312-21T**
21 cm **EF312-22T**
23 cm **EF312-24T**
Kilitli/With lock

18.5 cm **EF311-31T**
21 cm **EF311-32T**
23 cm **EF311-34T**
Kilitsiz/Without lock



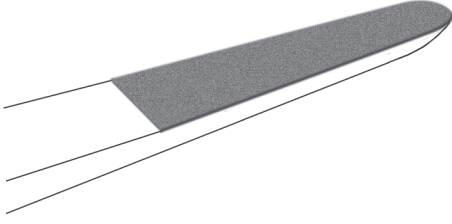

DIA MOTE ağızlar, daha sert ve aşınmaya dayanıklı yüzeyler sağlar.
DIA MOTE ağızlar, hassas iğne, suture ve dokuların güvenilir bir şekilde kavranmasını garanti eder.

DIA MOTE jaws provide harder and more wear resistant surfaces.
DIA MOTE jaws ensure reliable grip of fine needles, sutures and tissues.

Suture 7-0 ve daha
küçükler için
For sutures 7-0
and smaller

Suture 5-0 ve daha
küçükler için
For sutures 5-0
and smaller

Suture 7-0 ve daha
küçükler için
For sutures 7-0
and smaller

Suture 5-0 ve daha
küçükler için
For sutures 5-0
and smaller

Suture 4-0 ve daha
küçükler için
For sutures 4-0
and smaller

Suture 4-0 ve daha
küçükler için
For sutures 4-0
and smaller



12 cm EF310-01
14.5 cm -
16 cm EF310-02
18.5 cm EF310-03
21 cm EF310-04
23 cm EF310-05

EF310-01-EF310-10
Kilitsiz/Without lock



1/1

-
EF310-06
EF310-07
EF310-08
EF310-09
EF310-10



12 cm EF310-21
14.5 cm -
16 cm EF310-22
18.5 cm EF310-23
21 cm EF310-24
23 cm EF310-25

EF310-21-EF310-35
Kilitli/With lock



-
EF310-26
EF310-27
EF310-28
EF310-29
EF310-30



-
-
-
EF310-31
EF310-32
EF310-33



1/1

-
-
-
-
EF310-34
EF310-35



Suture 2-0 ve daha
küçükler için
For sutures 2-0
and smaller



19 cm EF310-44
23 cm EF310-46
25 cm EF310-48

EF310-44-EF310-48
Kilitsiz/Without lock



Suture 2-0 ve daha
küçükler için
For sutures 2-0
and smaller

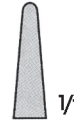

19 cm EF310-45
23 cm EF310-47
25 cm EF310-49

EF310-45-EF310-49
Kilitli/With lock

Düz Sap/Flat Handle

Sütür 7-0 ve daha
küçükler için
For sutures 7-0
and smaller

Sütür 5-0 ve daha
küçükler için
For sutures 5-0
and smaller

Sütür 7-0 ve daha
küçükler için
For sutures 7-0
and smaller

Sütür 5-0 ve daha
küçükler için
For sutures 5-0
and smaller



EF311-02-EF311-06
Kiltsiz/Without lock

14,5 cm	-	EF311-03
17 cm	EF311-02	-
18,5 cm	-	EF311-04
21 cm	-	EF311-05
23 cm	-	EF311-06



EF311-12-EF311-16
Kilitli/With lock

14,5 mm	-	EF311-13
17 cm	EF311-12	-
18,5 cm	-	EF311-14
21 cm	-	EF311-15
23 cm	-	EF311-16

Kanallı Düz Sap/Flat Knurled Handle

Sütür 5-0 ve daha
küçükler için
For sutures 5-0
and smaller

Sütür 5-0 ve daha
küçükler için
For sutures 5-0
and smaller

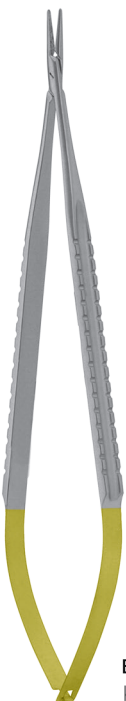

EF311-20-EF311-22
Kiltsiz/Without lock

18,5 cm	EF311-20
21 cm	EF311-21
23 cm	EF311-22



EF311-25-EF311-27
Kilitli/With lock

18,5 cm	EF311-25
21 cm	EF311-26
23 cm	EF311-27



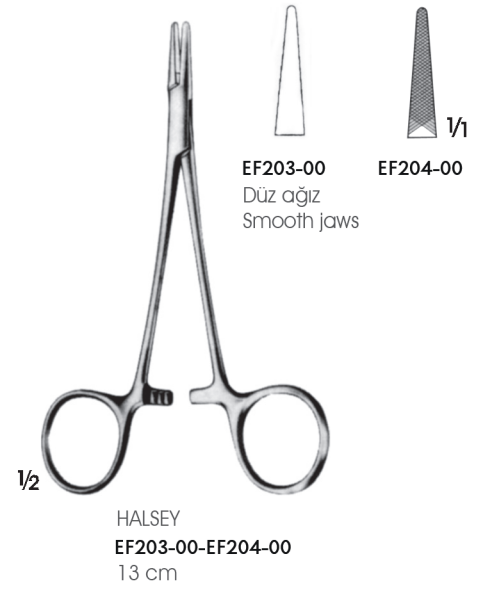
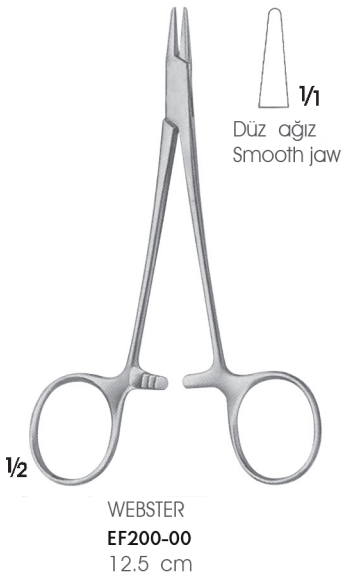



DOYEN
EF207-00
12.5 cm



CRILE-WOOD
EF215-00
15 cm

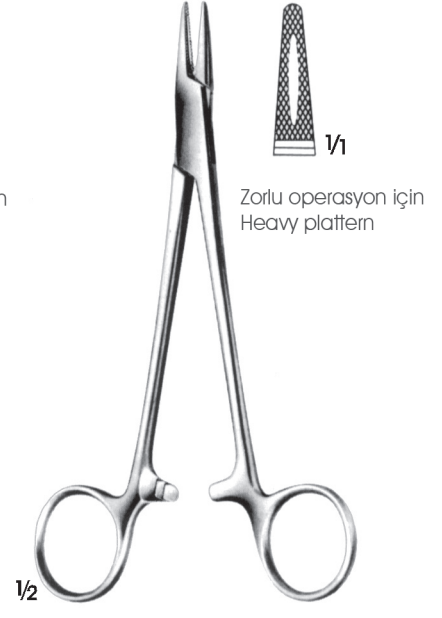

CRILE-WOOD
EF217-00
16 cm

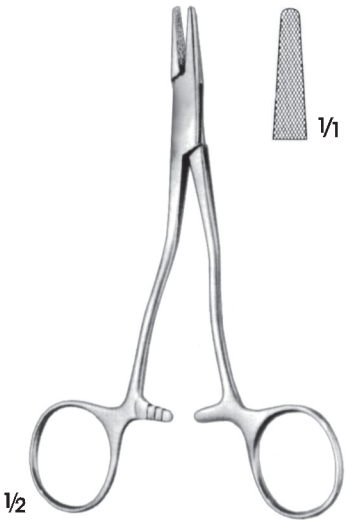

KILNER
EF221-00
13.5 cm



CRILE-MURRAY
EF219-00
15 cm

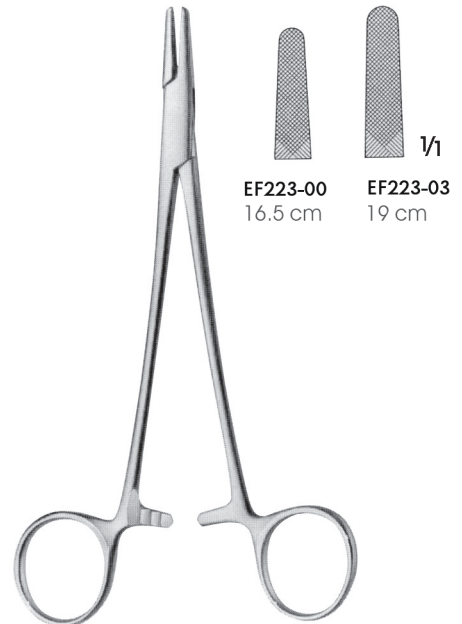

MAYO-HEGAR
EF223-00-EF223-03

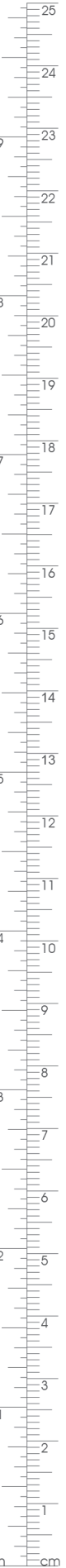



MAYO-HEGAR
EF230-00-EF230-04
Orta incelikte dikiş pensu
Medium fine patterns



HEGAR
EF231-00-EF232-04
Zorlu operasyon için
Heavy patterns



ADSON
EF234-00
17.5 cm

Ön ve damak için dikiş pensu
Designed for frontal and palate
suture



HEANEY
EF236-00
20 cm



JAMESON
EF237-00
23 cm



WANGENSTEEN
EF238-00
27.5 cm



MASSON
EF239-00
26.5 cm

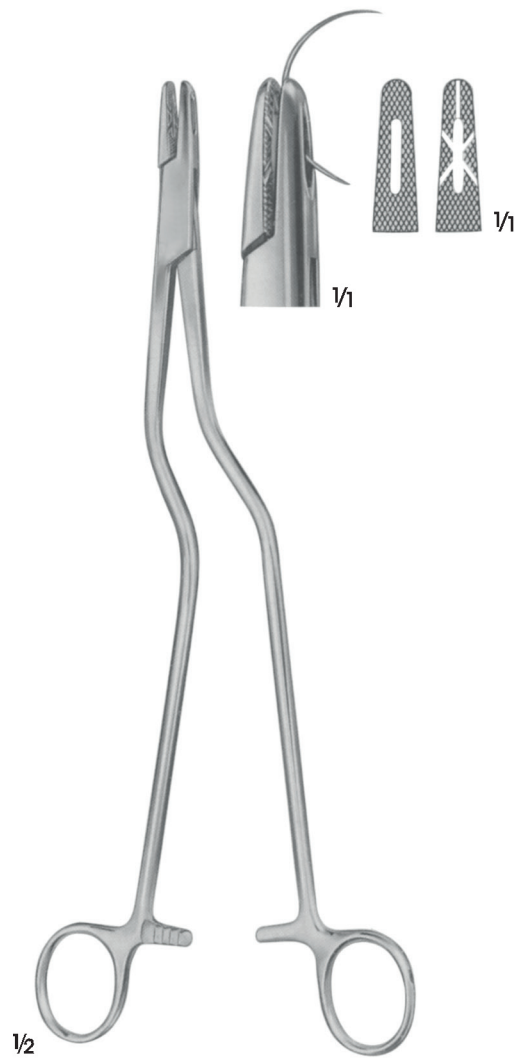

MASSON-LUETHY
EF240-00
25.5 cm





HEGAR-OLSEN
EF260-00-EF261-00

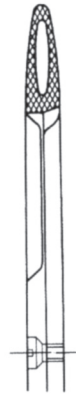

EF260-00
14 cm

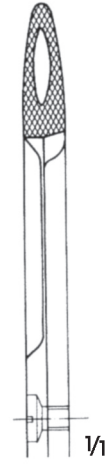

EF261-00
18.5 cm



GILLIES
EF268-00
15 cm



1/2

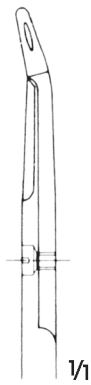

1/1



GILLIES
EF269-00
16 cm

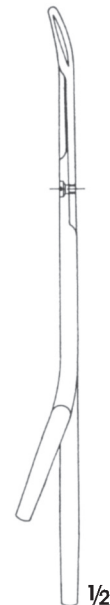

1/2

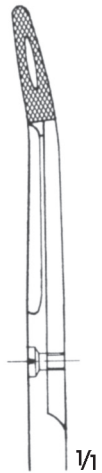

1/1



CRILE
EF250-00
15 cm



TÖNNIS
EF251-00
Dura ve bağırsak dikiş pensi
Elastic pattern for dura-or intestinal suture
18 cm

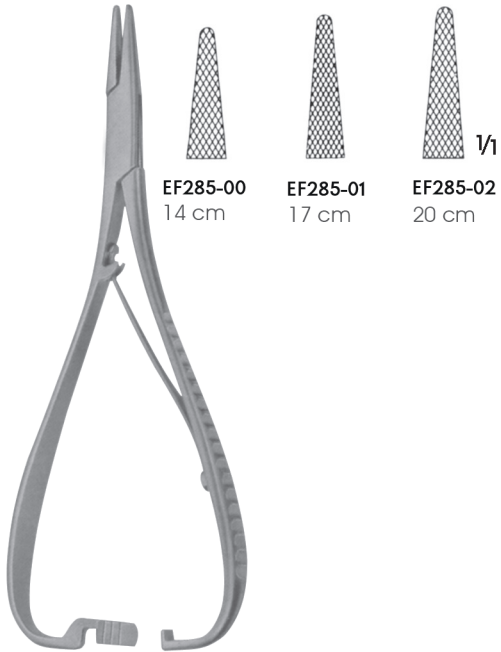

MATHIEU
EF285-00-EF285-02

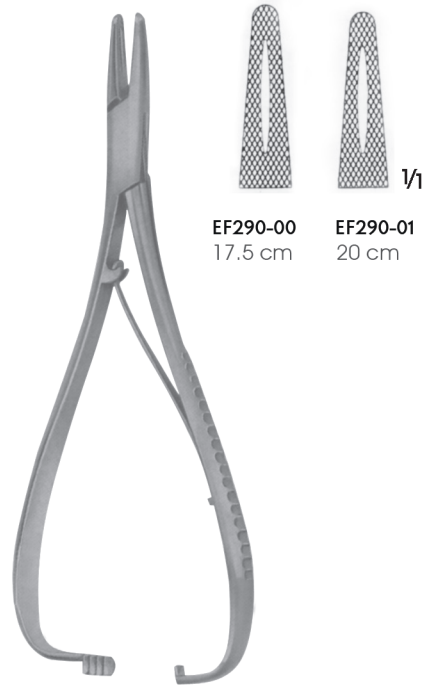

MATHIEU - STILLE
EF290-00-EF290-01
Çok zorlu operasyon için
Very heavy patterns



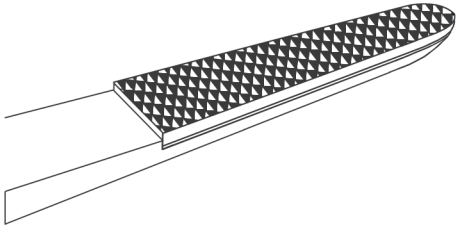

Elmas Uclu Portegüler :

Bahadır Portegülerinin ağızlarındaki elmas uclarının kullanıma göre yüzey yapısı seçilebilir.

Bahadır elmas uclu portegülerinin 4 farklı yüzeyi vardır. Pürüzsüz yüzey ve 3 farklı çentik yüzeyi uygun iğne yakalamayı sağlar.

Needle holders with carbide inserts.

The carbide inserts on BAHADIR needle holders can be selected based on usage.

BAHADIR needle holders with carbide inserts have four different surface types. Smooth surface and three different notched surfaces provide appropriate needle catch.



Düz
smooth

Pürüzsüz yüzeye sahip ağızlarda kullanılacak, dikiş malzemesi için: 9/0 - 11/0

With smooth jaw surface for suture materials: 9/0 - 11/0



0,2

0.2 mm adımlı çentiğe sahip ağızda kullanılacak, dikiş malzemesi için: 6/0 - 10/0

With 0.2 mm pitch of serration for suture material: 6/0 - 10/0



0,4

0.4 mm adımlı çentiğe sahip ağızda kullanılacak, dikiş malzemesi için: 4/0 - 6/0

0.4 mm pitch of serration for suture material: 4/0 - 6/0



0,5

0.5 mm adımlı çentiğe sahip ağızda kullanılacak, dikiş malzemesi için: 3/0' a kadar

0.5 mm pitch of serration for suture material: up to 3/0



HALSEY
EF320-00
12 cm



Düz ağız
With smooth jaw



WEBSTER
EF321-00-EF321-01
12.5 cm



EF321-00
Düz ağız
With smooth jaws

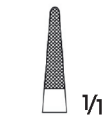

EF321-01
0,4



MASING
EF322-00
Tek ayağı açılı, yüzüklü
One ring angled
13 cm



0,4

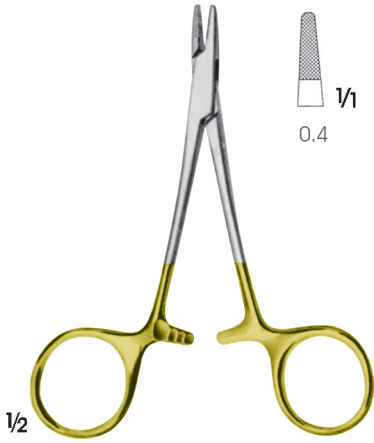

DERF
 EF323-00
 11.5 cm



HALSEY
 EF325-00
 13 cm

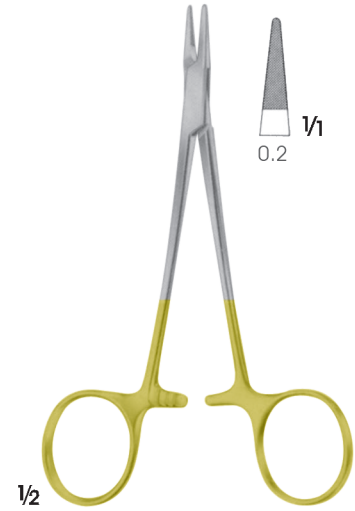

CONVERSE
 EF326-00
 13 cm

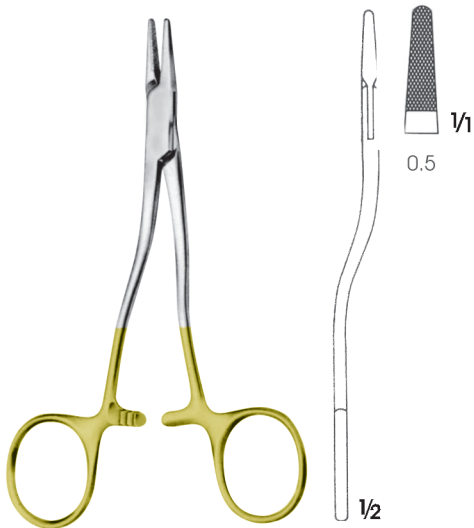

KILNER
 EF330-00
 13.5 cm

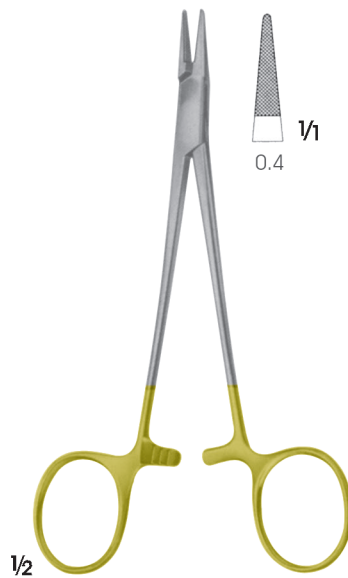

BABY-CRILE-WOOD
 EF328-00
 15 cm



BAUMGARTNER
 EF332-00
 14.5 cm





CRILE-WOOD
EF333-00-EF333-05

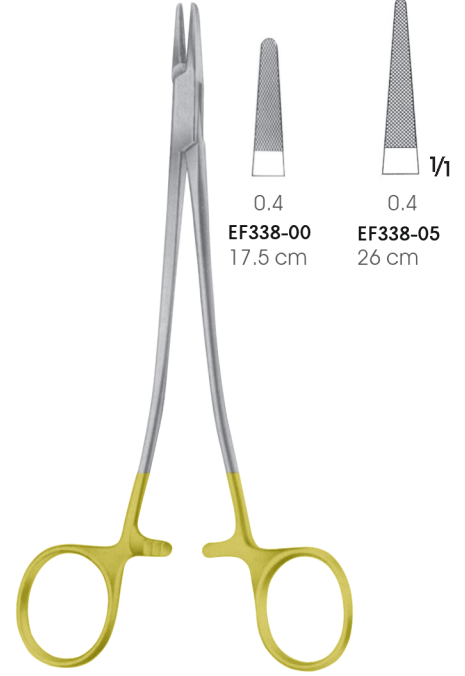
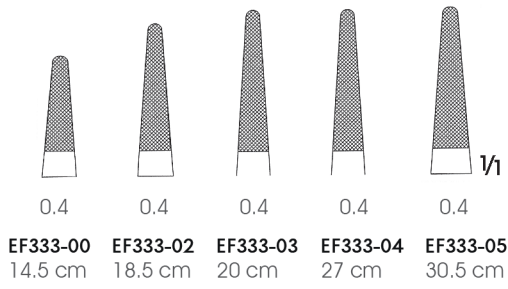

SAROT
EF338-00-EF338-05

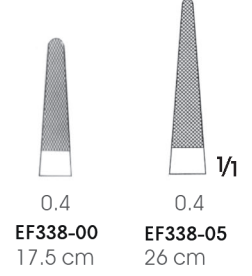

DE BAKEY
EF344-00-EF345-01
Çok hassas/Very delicate

fineCut

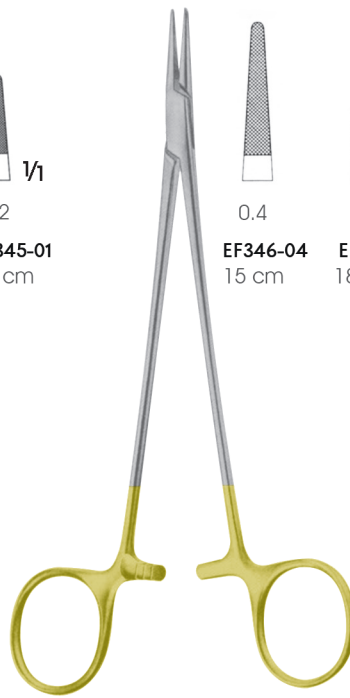
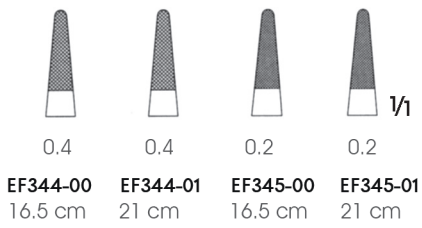

DE BAKEY
EF346-00-EF346-04

fineCut

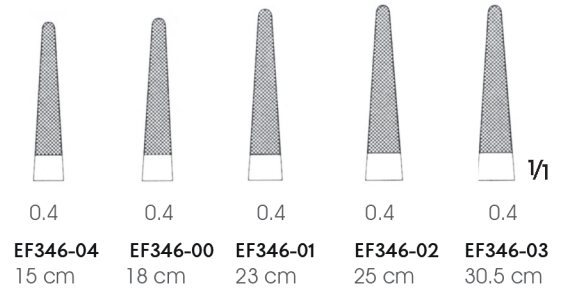



EF347-00-EF347-02
 Çok hassas/Very delicate



DE BAKEY
EF350-00-EF350-01
 Uzatılmış bir sap ve kavisli yüzükler,
 optimum tutuş sağlar.
 One extended handle and curved
 rings ensure optimum grip

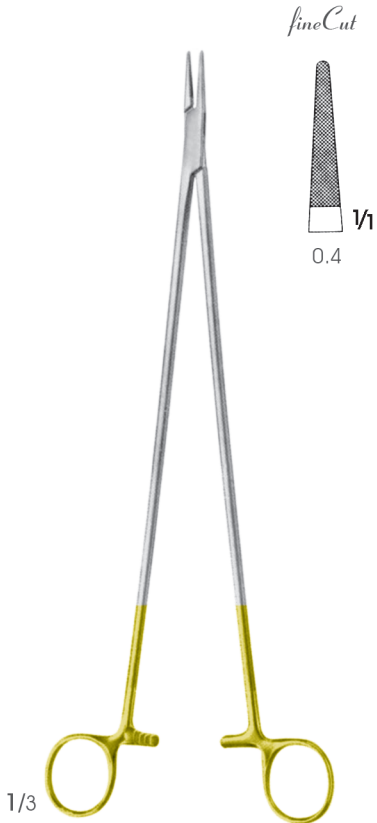

DE BAKEY
EF346-05
 Narin model/Slender pattern
 30.5 cm

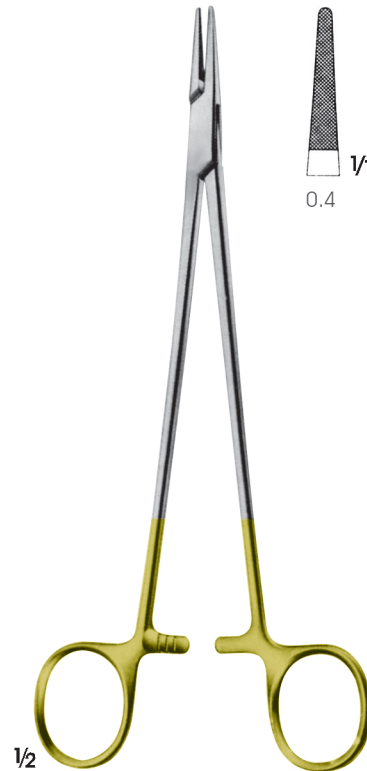

HEGAR-MAYO-SEELEY
EF356-00
 20 cm





HEGAR-MAYO
EF355-00-EF355-04

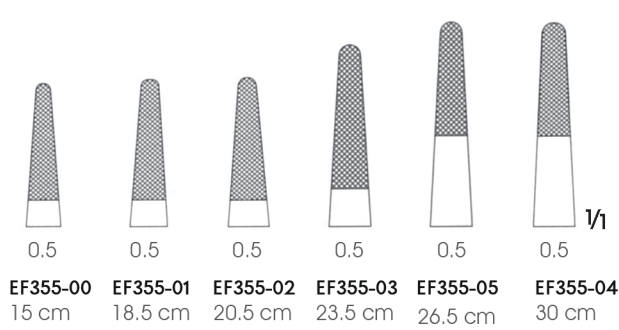

HEGAR
EF357-00-EF357-01
Zorlu operasyon için
Heavy patterns



EF340-00
 12.5 cm



HEGAR-HELSON
EF341-00
 14.5 cm

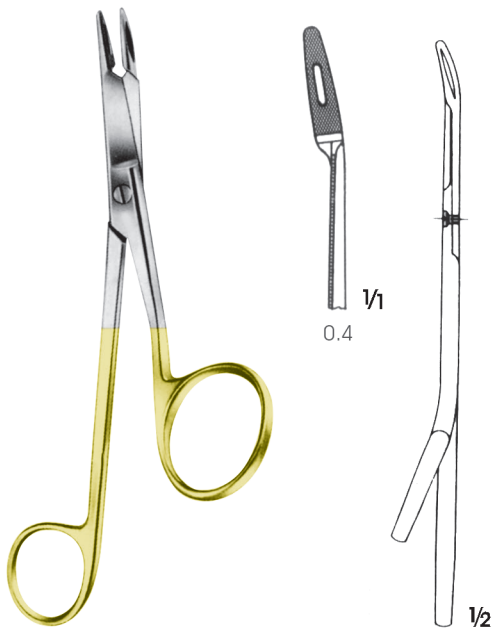

GILLIES
EF342-00
 16 cm

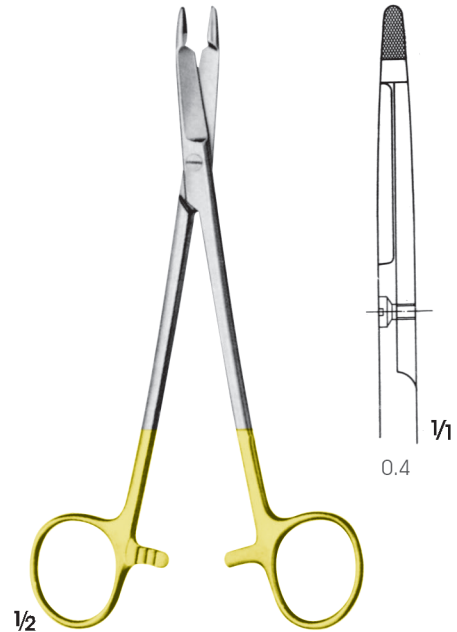

HEGAR-OLSEN
EF343-01
 Tek ağız tırnıklı
 one blade fine serrated
 16.5 cm



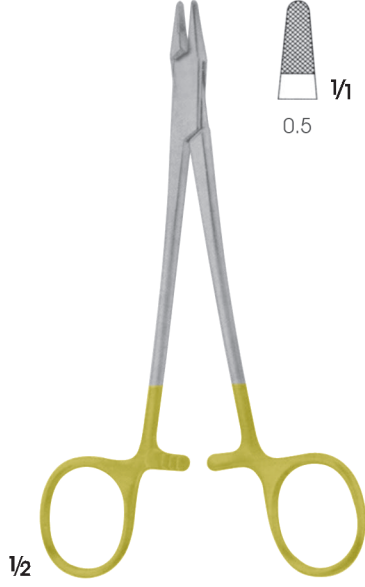

EF334-00
Tel bükücü/Wire twister
15 cm



EF336-00
Tel bükücü/Wire twister
15 cm

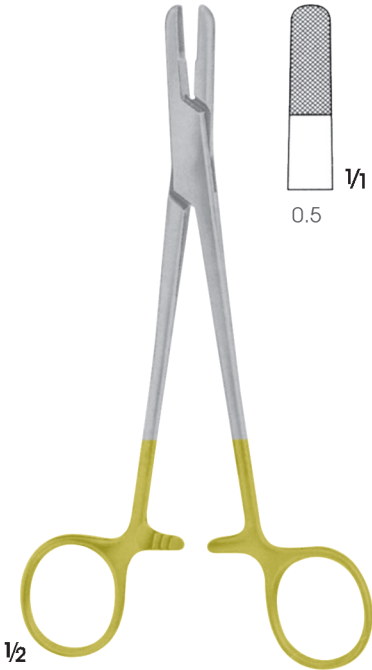

EF337-01
Tel Bükücü/ Wire twister
Sternum suture için ligatür pens
Sternum suture for ligature forceps
17.5 cm



BERRY
EF335-00
Tel bükücü/Wire twister
Ligatür pens/Ligature forceps
18.5 cm



BAUMGARTNER
EF339-01
Tel bükücü/Wire twister
Ligatür pens/Ligature forceps
20 cm

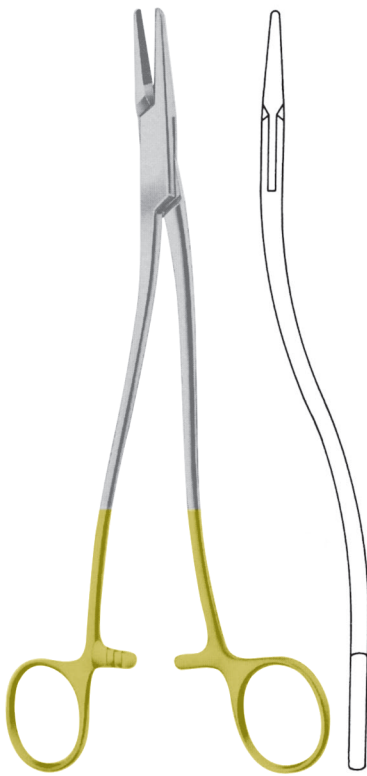

WERTHEIM
 EF370-00-EF370-02

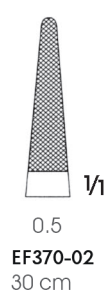
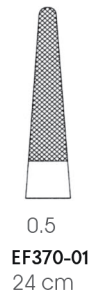
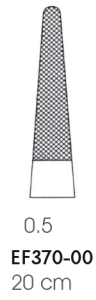

HEANEY
 EF373-00-EF373-02

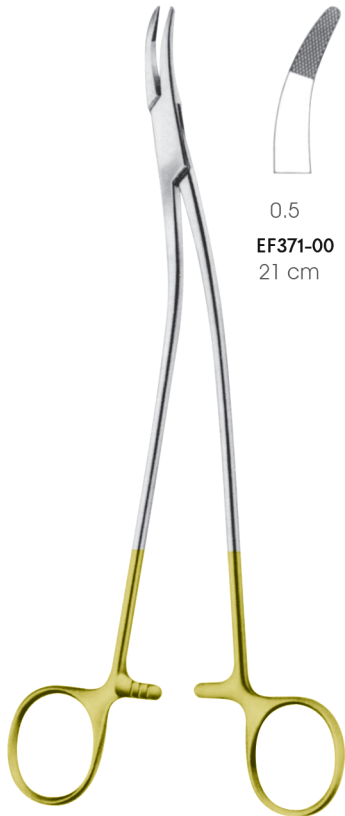
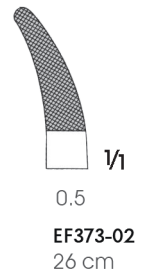

STRATF
 EF371-00-EF371-01

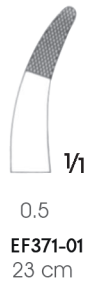

EF374-00
 S şekli portegü/S-shaped needle
 21.5 cm

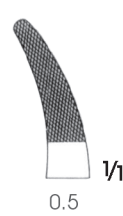

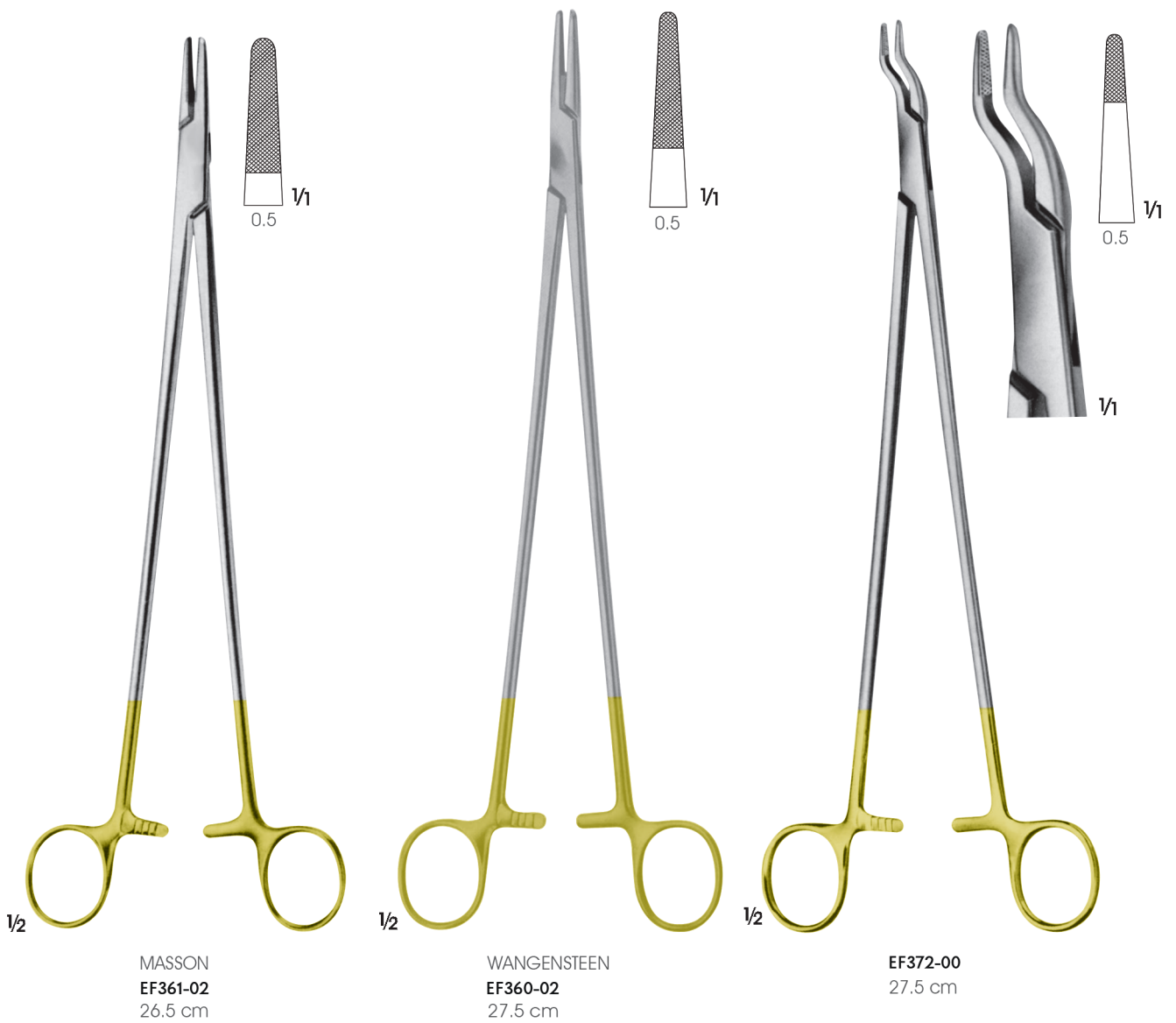

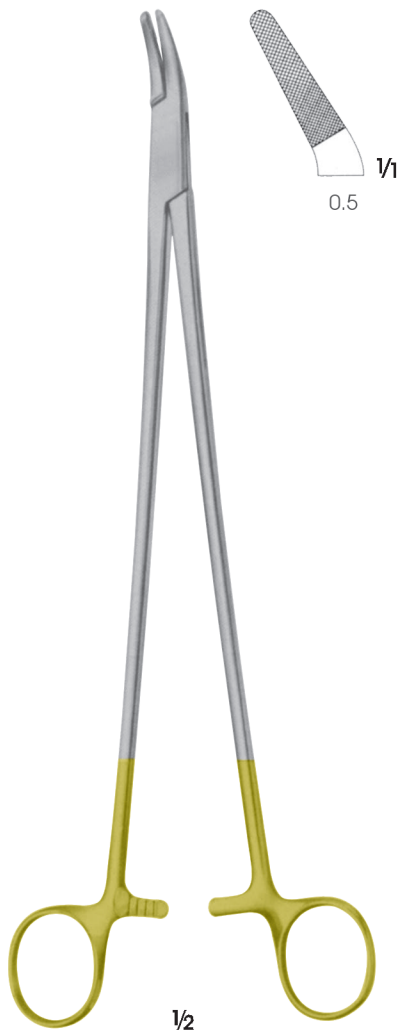

$\frac{1}{2}$
 FINOCHIETTO
EF363-02
 26.5 cm



$\frac{1}{2}$
 NAUNTON-MORGAN
EF353-00
 26 cm



$\frac{1}{2}$
 MÜLLER
EF354-00
 Derin rektum cerrahisi için
 For deep rectum surgery
 36 cm



- Hassas çeneler travmatik olmayan ve hassas damar iğnelerini tutmak için uygundur.
- Fine jaws are suitable for gripping non-traumatic needles and vein needles.

fineCut

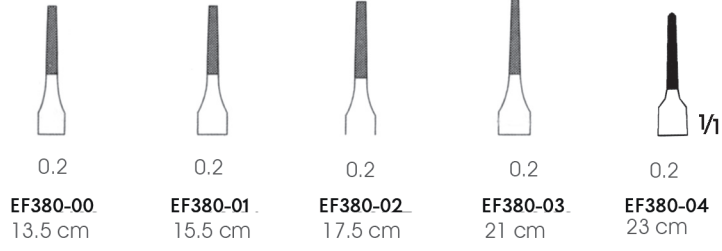

RYDER
EF380-00-EF380-04
Çok hassas/Very delicate

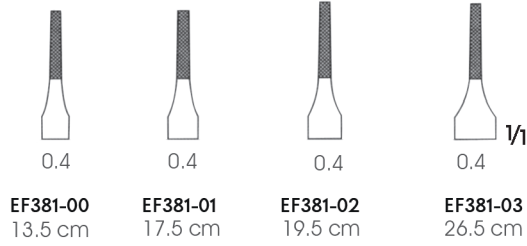

RYDER
EF381-00-EF381-03

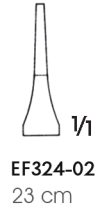

RYDER
EF324-00-EF324-02
 Düz ağız/With smooth jaws

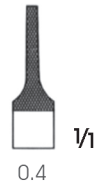

- Cerraha maksimum ergonomik rahatlık sağlar.
- Optimize tasarımları sayesinde zor suture ve anastomoz tekniklerinde yorulmadan çalışmayı sağlar.
- Provides maximum ergonomic comfort to surgeon.
- Due to optimized design, it provides fatigue free working on suture and anastomosis techniques.



REIN-KUPKA
EF382-00
Kilitli/Without ratchet lock
19 cm



REIN-KUPKA
EF383-00
Kilitli/ With ratchet lock
19 cm



HELLBERG-KUPKA
EF388-00
Kilitli/ With ratchet lock
21 cm

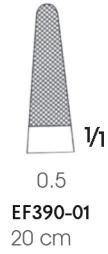
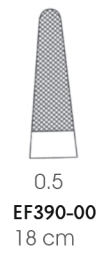

LANGENBECK
EF390-00-EF390-01



LANGENBECK
EF391-00
 Elastik model/Elastic pattern
 20 cm

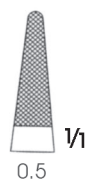

$\frac{1}{2}$

TÖNNIS
EF387-00
 Elastik model/Elastic pattern
 18 cm

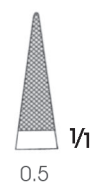

$\frac{1}{2}$

TÖNNIS
EF384-00
 Elastik model/Elastic pattern
 18 cm

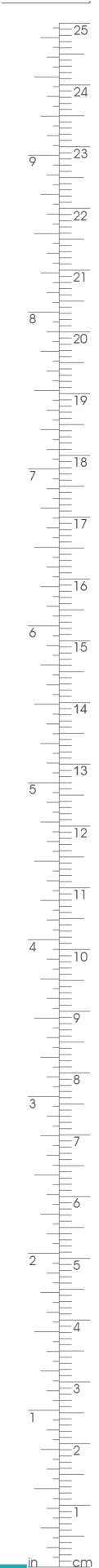

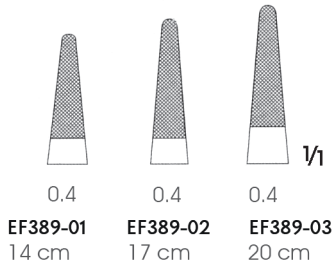

MATHIEU
EF389-01-EF389-03
Hassas model/Delicate patterns

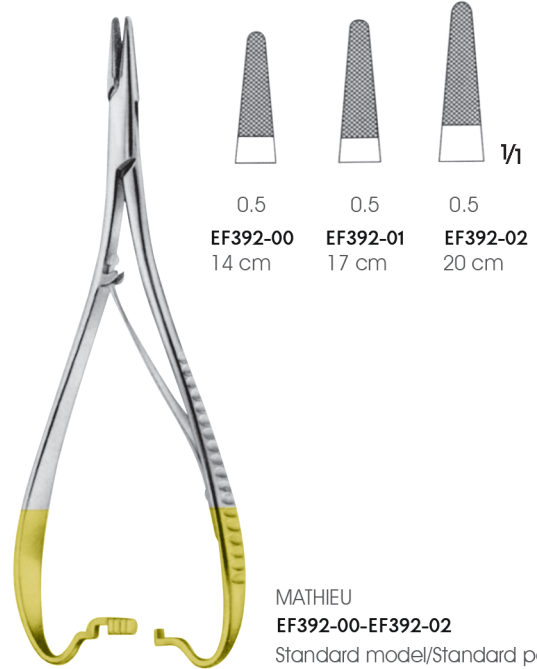

MATHIEU
EF392-00-EF392-02
Standard model/Standard patterns

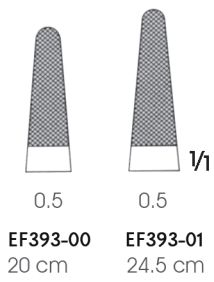

MATHIEU
EF393-00-EF393-01
Zorlu operasyon için
Heavy patterns



EF394-00
Uzun boyunlu
With long neck
20.5 cm



LICHTENBERG
EF396-00
Elastik model
Elastic pattern
19.5 cm

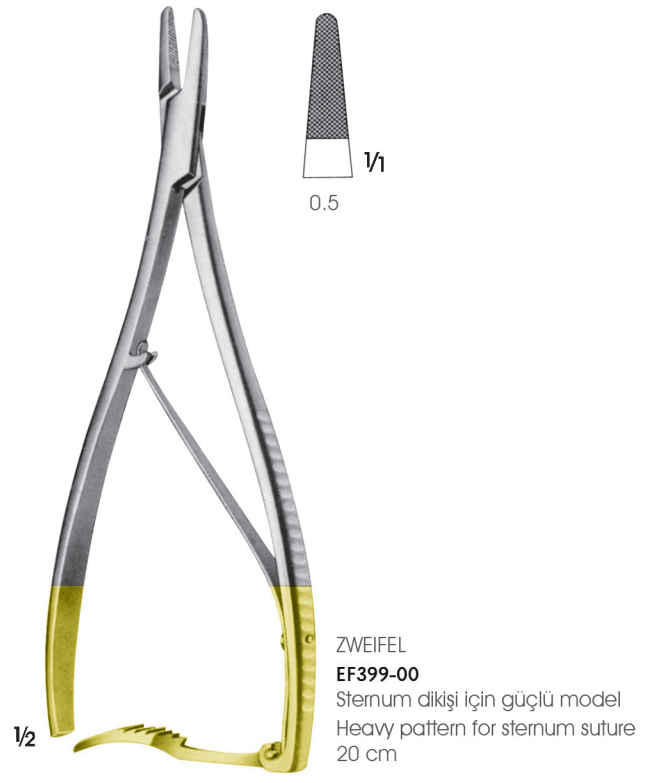



YOUNG-HRYNTSCHAK
EF406-00
1 iğne ile F 400.00
With 1 needle F 400.00
24 cm



MILLIN
EF408-00
Ligatur tutucu pens
Ligature holding forceps
28.5 cm

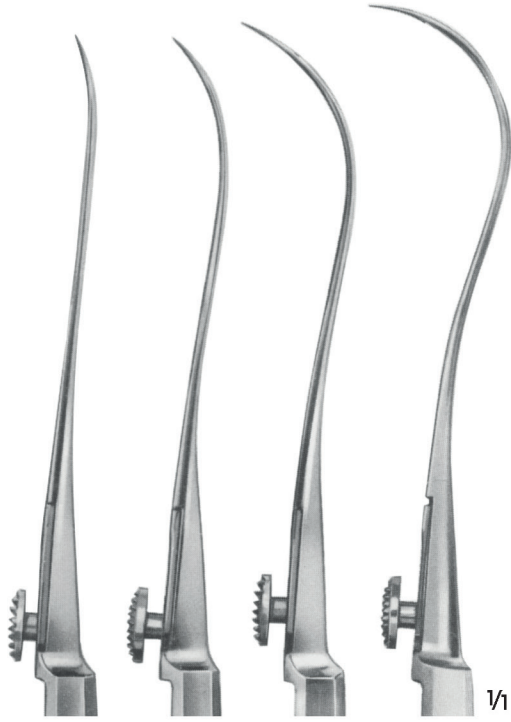

EF411-00

EF411-01

EF411-02

EF411-03

1/1



EF412-03

EF412-01

EF412-02

EF412-03

1/1

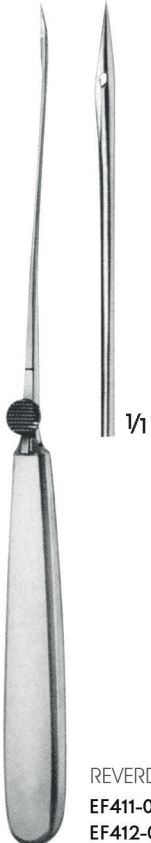

REVERDIN

EF411-00-EF411-03 19.5 cm

EF412-00-EF412-03 22 cm



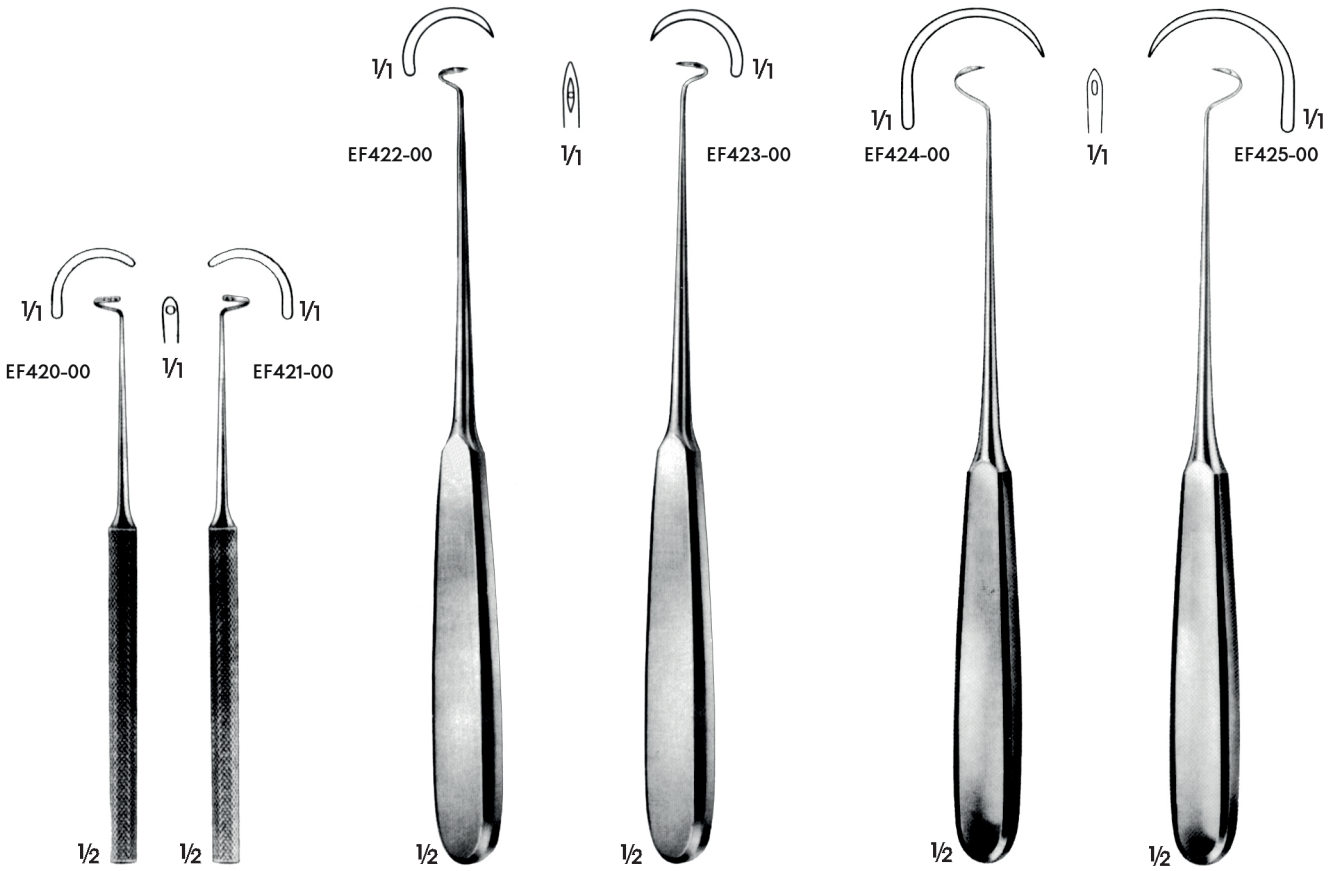

KRONECKER
EF420-00
Sağ el için, künt
For right hand blunt
EF421-00
Sol el için, künt
For left hand blunt
15.5 cm

DESCHAMPS
EF422-00
Sağ el için, sivri
For right hand sharp
EF423-00
Sol el için, sivri
For left hand sharp
21 cm

HURD
EF424-00
Sağ el için, sivri
For right hand sharp
EF425-00
Sol el için, sivri
For left hand sharp
21 cm



1/1
EF428-00

1/2

DESCHAMPS
EF428-00
Sağ el için, künt
For right hand blunt



1/1
EF429-00

1/2

EF429-00
Sol el için, künt
For left hand blunt
22.5 cm

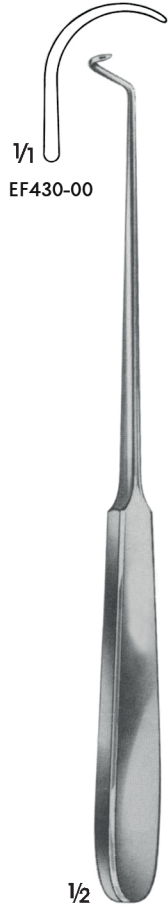

1/1
EF430-00

1/2

DESCHAMPS
EF430-00
Sağ el için, künt
For right hand blunt

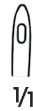

1/1
EF431-00

1/2

EF431-00
Sol el için, künt
For left hand blunt
22.5 cm



1/1
EF432-00

1/2

DESCHAMPS
EF432-00
Sağ el için, künt
For right hand blunt



1/1
EF433-00

1/2

EF433-00
Sol el için, künt
For left hand blunt
21.5 cm



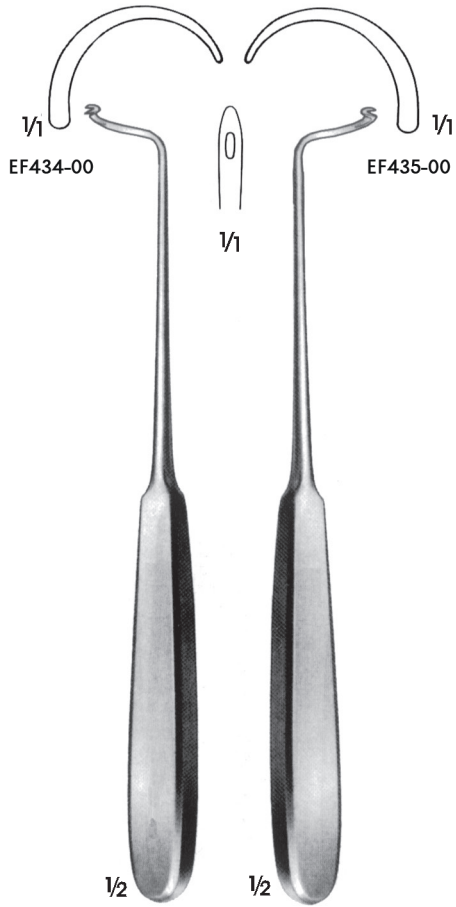

DESCHAMPS
EF434-00
Sağ el için, künt
For right hand blunt
EF435-00
Sol el için, künt
For left hand blunt
21 cm

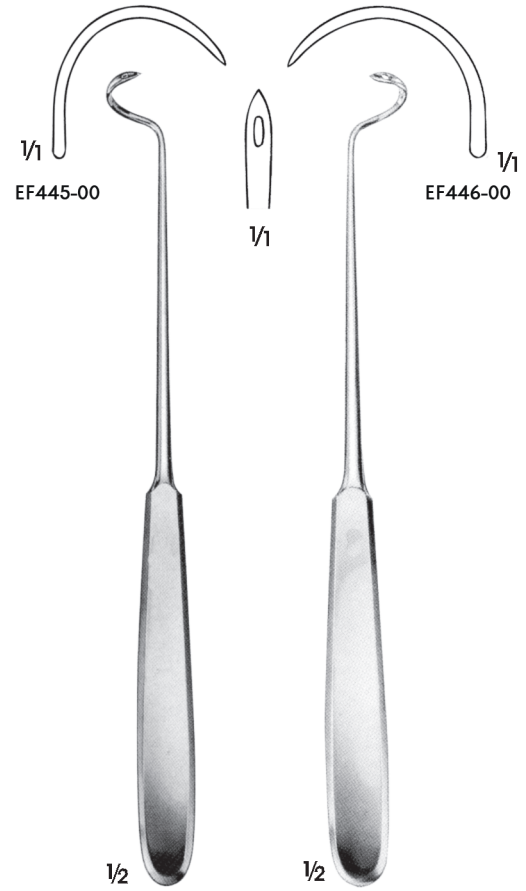

DESCHAMPS
EF445-00
Sağ el için, sivri
For right hand sharp
EF446-00
Sol el için, sivri
For left hand sharp
21.5 cm

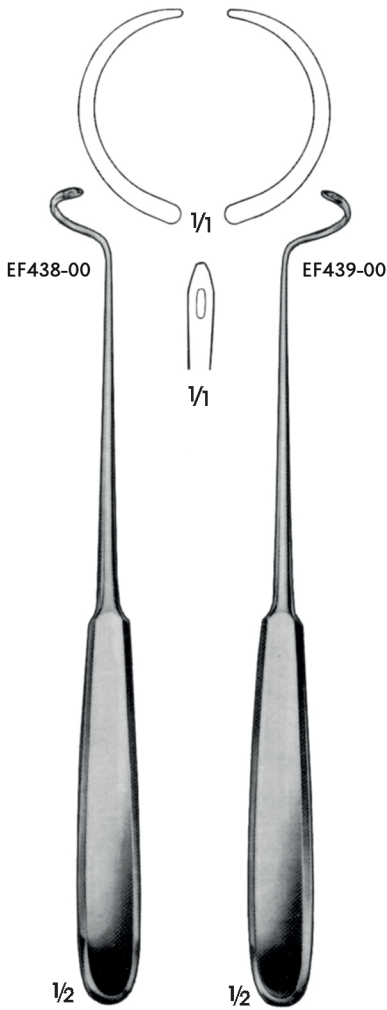

DESCHAMPS
EF438-00
Sağ el için, künt
For right hand blunt
EF439-00
Sol el için, künt
For left hand blunt
21.5 cm

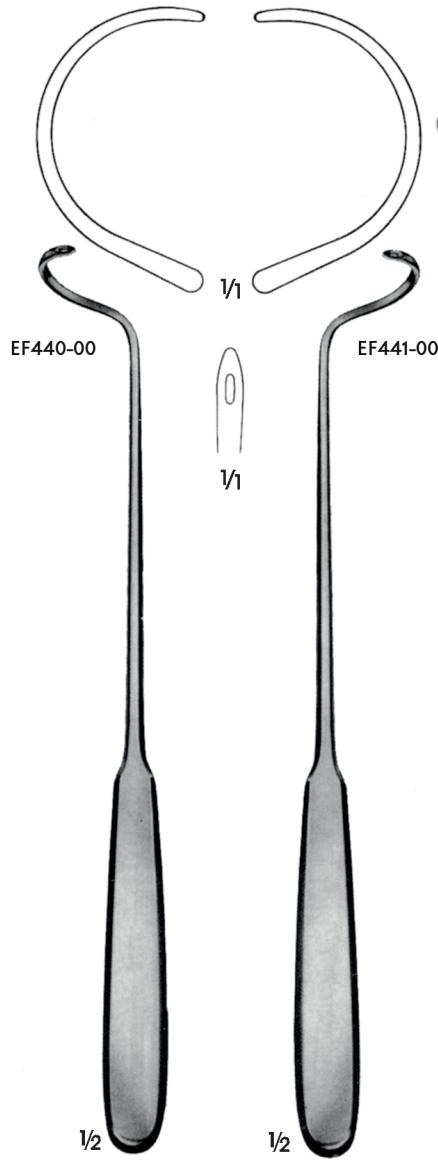

DESCHAMPS
EF440-00
Sağ el için, künt
For right hand blunt
EF441-00
Sol el için, künt
For left hand blunt
24 cm

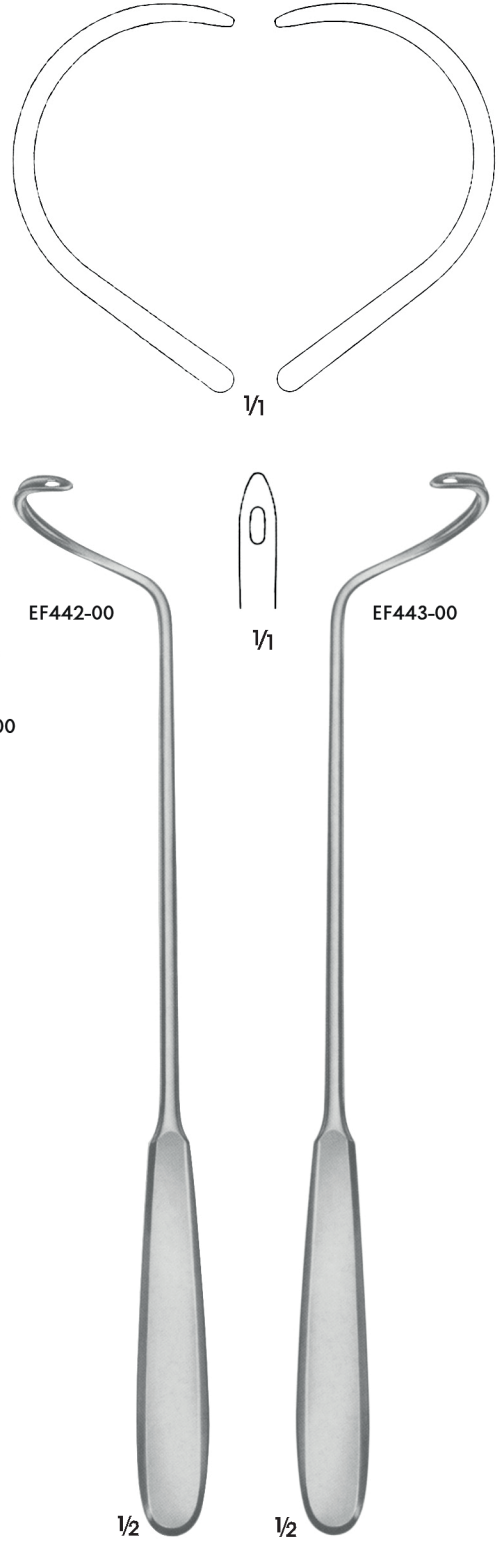

DESCHAMPS
EF442-00
Sağ el için, künt
For right hand blunt
EF443-00
Sol el için, künt
For left hand blunt
28 cm



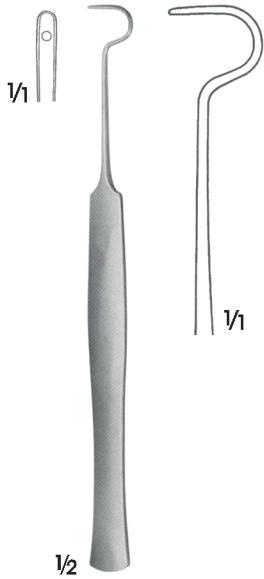

EF450-00
15 cm

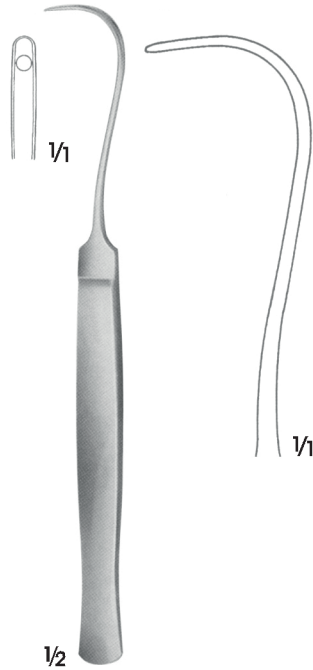

SYME
EF454-00
17 cm



JONESCO
EF453-00
Dikiş teli klavuzu
Needle for wire suture
18.5 cm

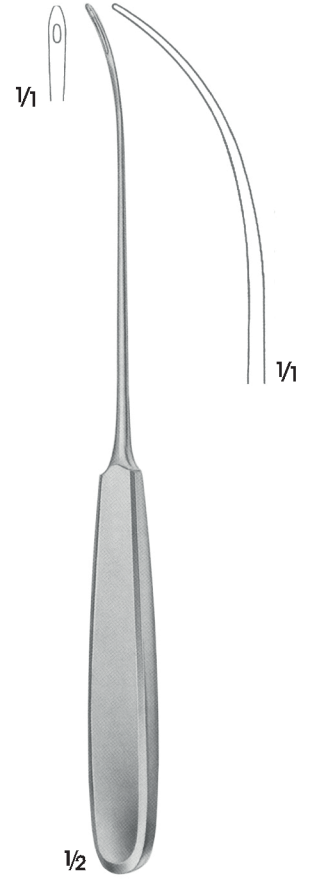

EF460-00
Bükülebilir/Malleable
23 cm

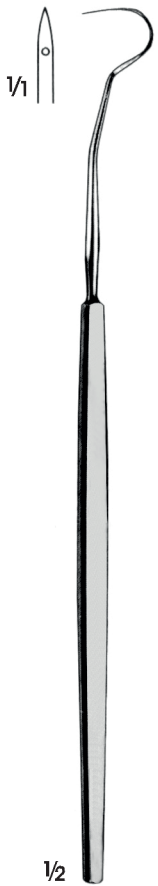

1/2
CLAUS VAN EICKEN
EF451-00
25 cm

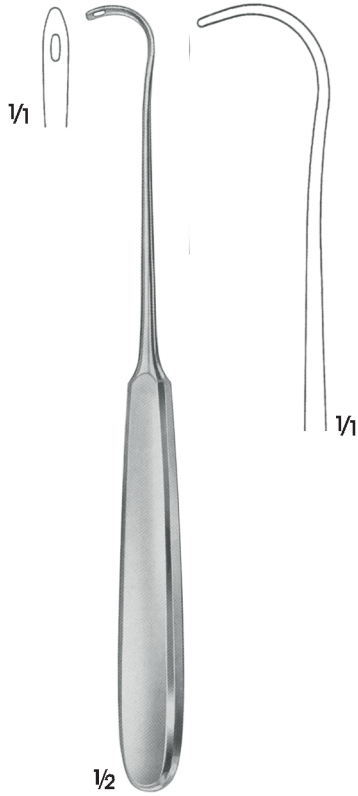

1/2
COOPER
EF455-00
20.5 cm

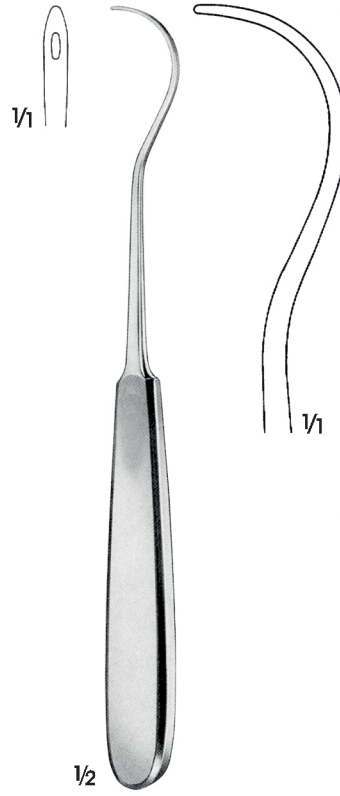

1/2
KOCHER
EF456-00
20.5 cm

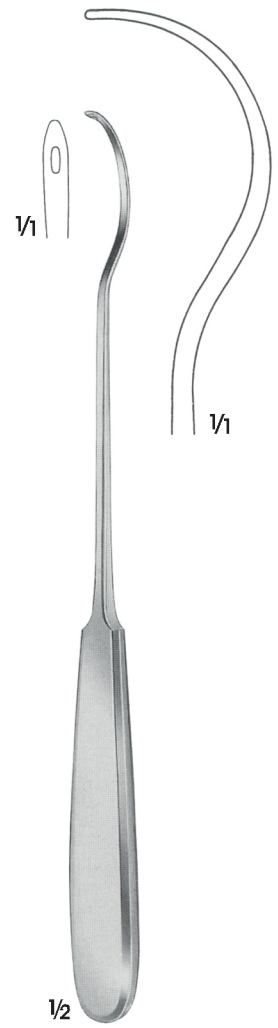

1/2
BRUNNER
EF461-00
24 cm



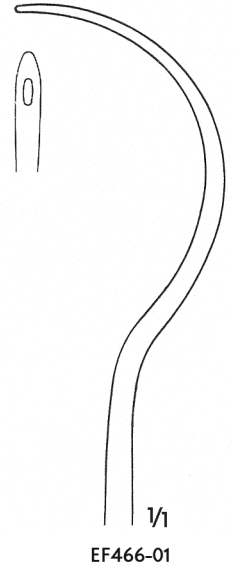

1/2

BRUNNER
EF465-00-EF465-01
Kilavuz sondaları/Guiding probes
30 cm

1/2

BRUNNER
EF466-00-EF466-01
Bağlama iğneleri/Ligature needles
30 cm



EF480-00
20 cm



**KÖNIG
EF481-00**
19.5 cm



**KÖNIG
EF482-00**
20 cm



**SCHMIEDEN
EF483-00**
18.5 cm

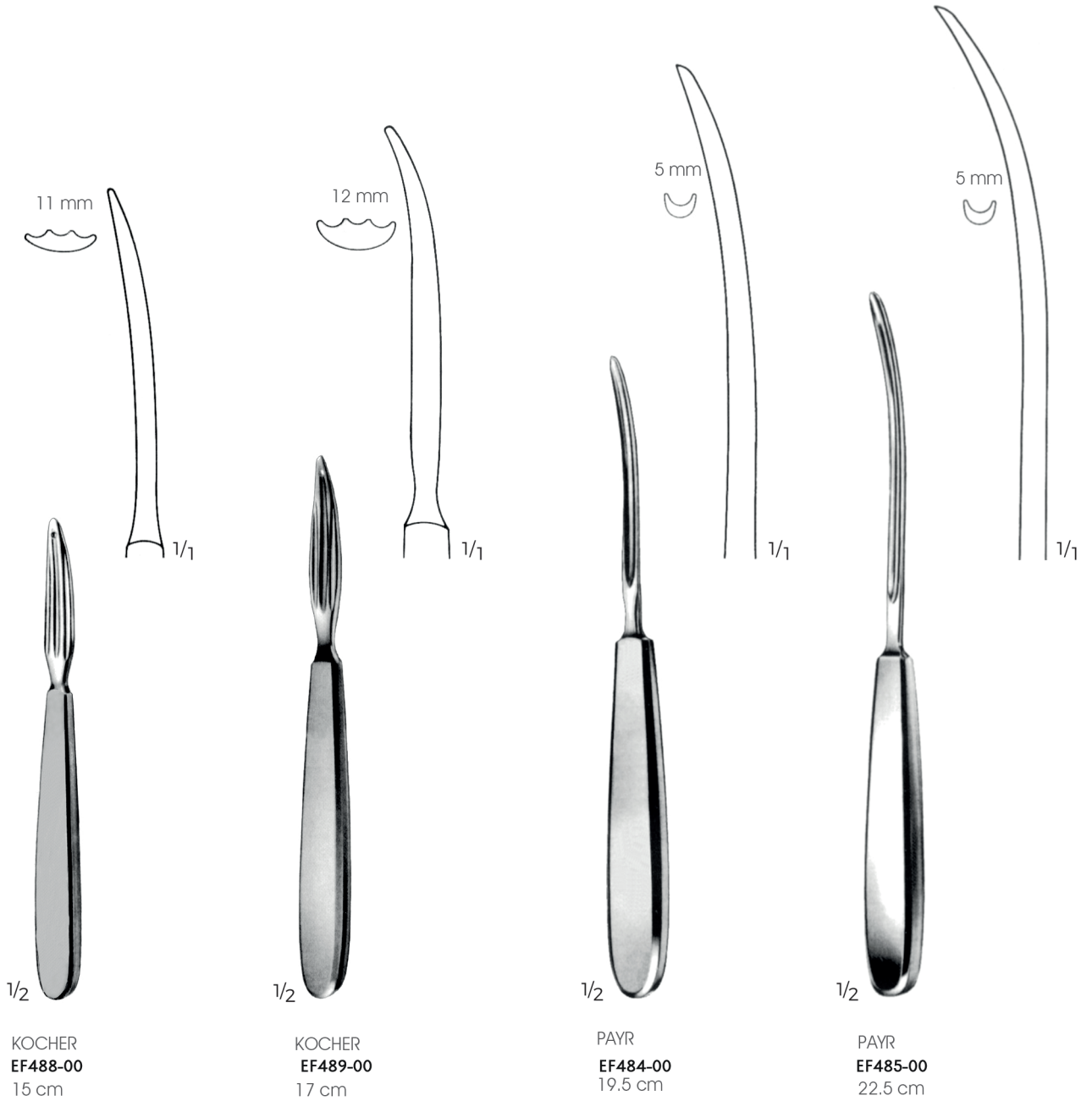

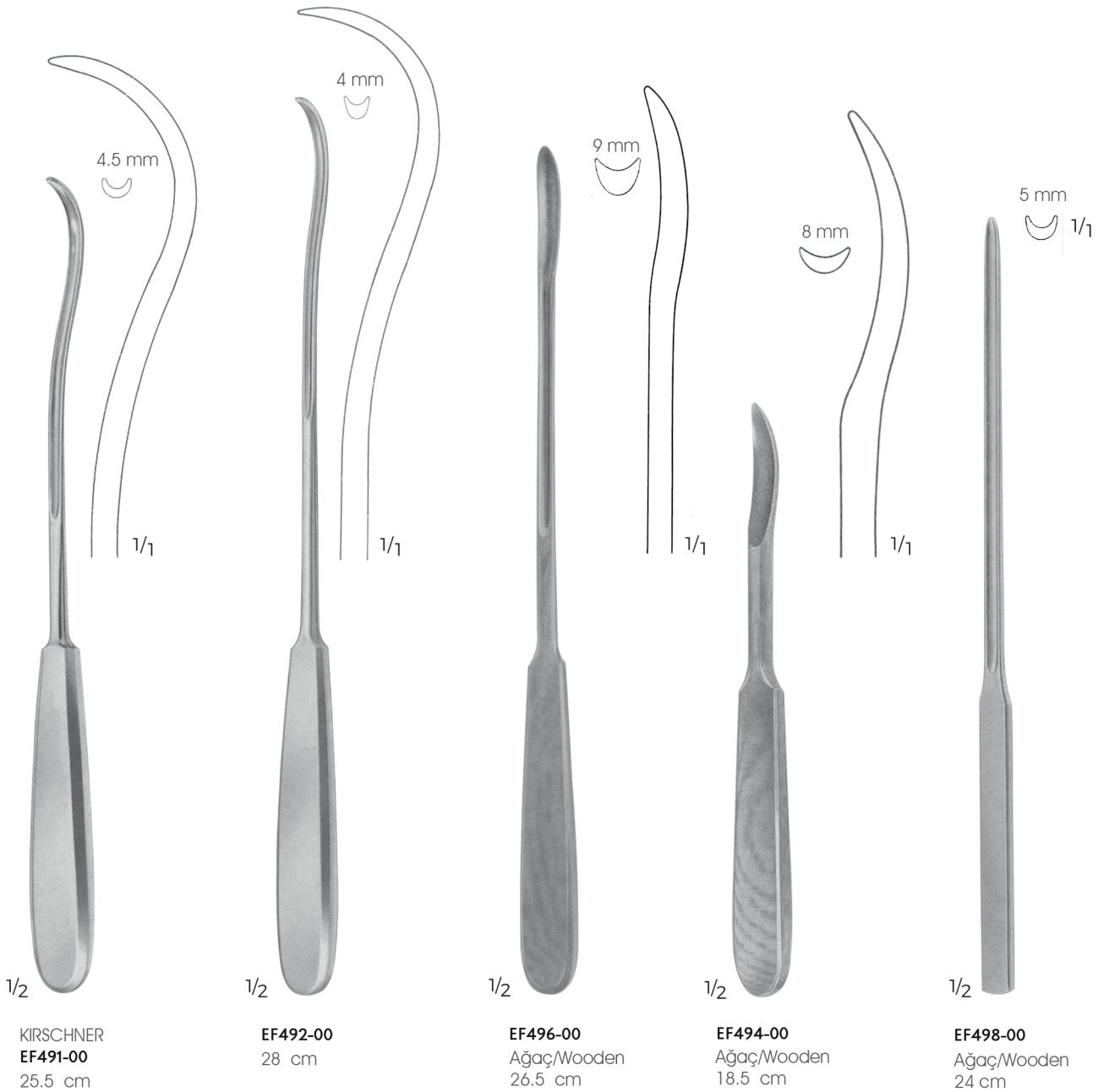



1/2
HEGENBARTH
EF601-00
Klip uygulayıcı penset
Clip applying forcep
12 cm



1/2
MICHEL
EF605-00
Klip uygulayıcı penset
Clip applying forcep
12.5 cm



1/2
MICHEL
EF620-00
Klip uygulayıcı ve çıkarıcı pens
Clip applying and removing forcep
12.5 cm



1/2
MICHEL
EF621-00
Klip Uygulayıcı ve çıkarıcı pens
Clip applying and removing forcep
13 cm

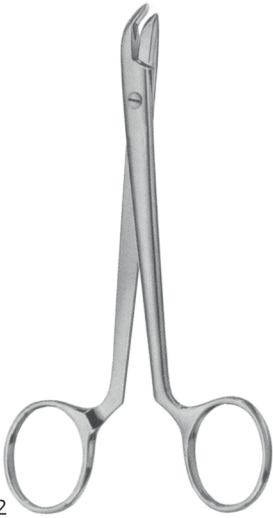

1/2
COLLIN
EF630-00
Klip çıkarıcı pens
Clip removing forcep
13.5 cm



1/2
HEATH
EF631-00
Klip çıkarıcı pens
Clip removing forcep
13.5 cm



1/2
ET083-00
Düğüm aparatı
Attachment node
23 cm



1/1



1/2
CASPAR
ET084-02
Düğüm aparatı
Attachment node
23 cm



1/1

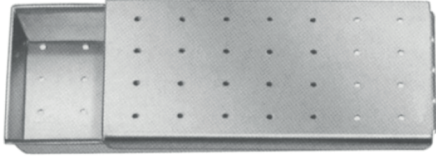

EF952-00
50 x 25 x 5 mm
EF952-01
50 x 30 x 6 mm
EF952-04
70 x 25 x 5 mm

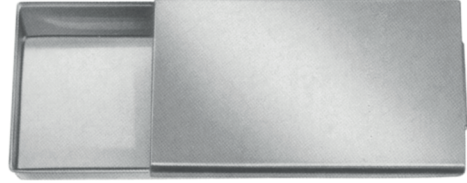

EF950-00
60 x 25 x 11 mm
EF950-01
70 x 53 x 9 mm



EF954-00
150 x 90 x 10 mm



EF956-00
205 x 120 x 12 mm



EF960-00 65 x 16 mm İç kutu ve dış kutu takım/Needle case with interior box
EF962-00 95 x 16 mm İç kutu ve dış kutu takım/Needle case with interior box
EF964-00 65 x 16 mm F 960.00 için sadece dış kutu/Exterior box of F 960.00
EF961-00 62 x 17 mm F 960.00 için iç kutu/Interior box of F 960.00 only
EF963-00 90 x 17 mm F 962.00 için iç kutu/Interior box of F 960.00 only



