

# EEC

Elektrocerrahi Aletleri

Electrosurgical Instruments





**EZ121-00**  
12 cm



**EZ120-00**  
11 cm



**EZ100-00**  
14.5 cm



**EZ130-00**  
Sivi/Sharp  
12.5 cm



**EZ130-02**  
Hassas/Delicate  
17.5 cm



**EZ130-04**  
Hassas/Delicate  
22 cm

Yapışmaz/Non sticking

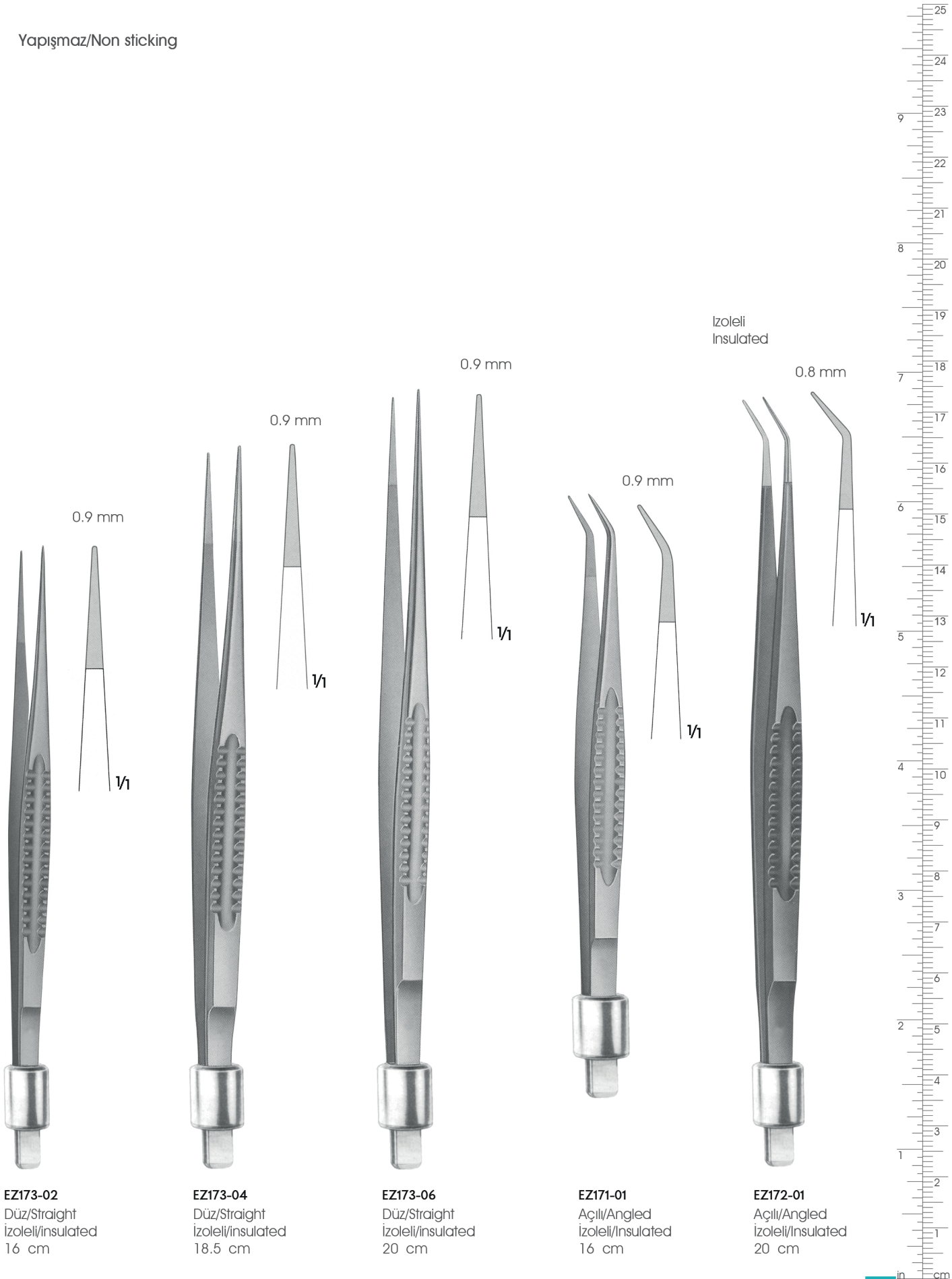

Izoleli  
Insulated



**EZ150-00** 0.6 mm  
**EZ150-01** 0.9 mm  
16 cm  
**EZ150-03** 0.9 mm  
20 cm

Izoleli  
Insulated



**EZ150-03** 0.9 mm  
20 cm  
**EZ151-01** 0.9 mm  
16 cm

Izoleli  
Insulated



**EZ160-00** 0.4 mm  
**EZ160-01** 0.7 mm  
**EZ160-02** 1.0 mm  
**EZ160-03** 1.3 mm  
14 cm  
**EZ160-04** 0.4 mm  
**EZ160-05** 0.7 mm  
**EZ160-06** 1.0 mm  
**EZ160-07** 1.3 mm  
15.5 cm  
**EZ160-08** 0.4 mm  
**EZ160-09** 0.7 mm  
**EZ160-10** 1.0 mm  
**EZ160-11** 1.3 mm  
17.5 cm  
**EZ160-12** 0.4 mm  
**EZ160-13** 0.7 mm  
**EZ160-14** 1.0 mm  
**EZ160-15** 1.3 mm  
19.5 cm  
**EZ160-16** 0.4 mm  
**EZ160-17** 0.7 mm  
**EZ160-18** 1.0 mm  
**EZ160-19** 1.3 mm  
21.5 cm  
**EZ160-20** 0.4 mm  
**EZ160-21** 0.7 mm  
**EZ160-22** 1.0 mm  
**EZ160-23** 1.3 mm  
23.5 cm  
**EZ160-26** 0.7 mm  
25.5 cm

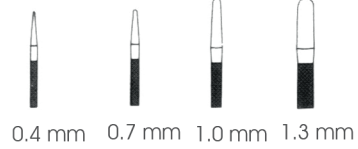

#### Özellikler

- Doku hazırlanması ve ayırması için uygun.
- Yuvarlak çalışma uçları.
- Dayanıklı izolasyon kaplaması.
- Güvenilir fişli bağlantı.

#### Features

- Suitable for tissue preparation and spreading.
- Rounded working tips.
- Durable insulation coating.
- Reliable plug-in connection.

Izoleli  
Insulated

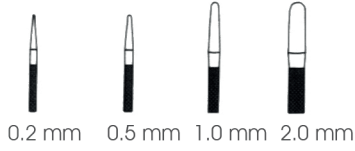

Özellikler

- İnce, hassas, yuvarlak, parlak çaloşma
- Dayanıklı izolasyon kaplaması.
- Güvenilir fişli bağlantı.

Features

- Slim, delicate, rounded, polished working tips.
- Durable insulation coating.
- Reliable plug-in connection.

EZ200-00	0.2 mm	EZ200-08	0.2 mm
EZ200-01	0.5 mm	EZ200-09	0.5 mm
EZ200-02	1.0 mm	EZ200-10	1.0 mm
EZ200-03	2.0 mm	EZ200-11	2.0 mm
	16.5 cm		22 cm
EZ200-04	0.2 mm		
EZ200-05	0.5 mm		
EZ200-06	1.0 mm		
EZ200-07	2.0 mm		
	19.5 cm		

Izoleli  
Insulated



EZ202-00	1.0 mm
	16.5 cm
EZ202-02	1.0 mm
	19.5 cm
EZ202-04	1.0 mm
	22 cm

Izoleli  
Insulated

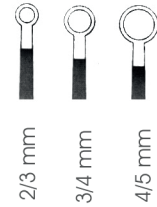
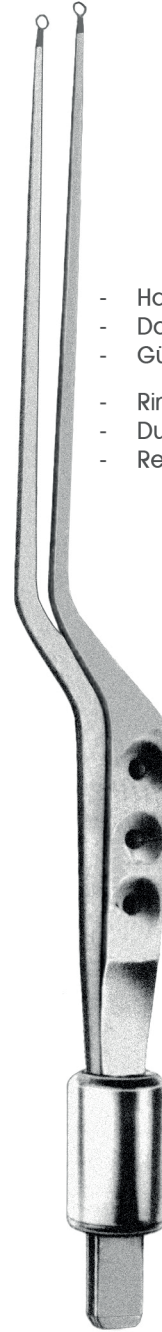

- Halka uçlar
- Dayanıklı izolasyon kaplaması.
- Güvenilir fişli bağlantı.
- Ring tips
- Durable insulation coating.
- Reliable plug-in connection.

EZ213-00	2/3 mm	EZ215-00	2/3 mm
EZ213-01	3/4 mm	EZ215-01	3/4 mm
EZ213-02	4/5 mm	EZ215-02	4/5 mm
	19.5 cm		23.5 cm

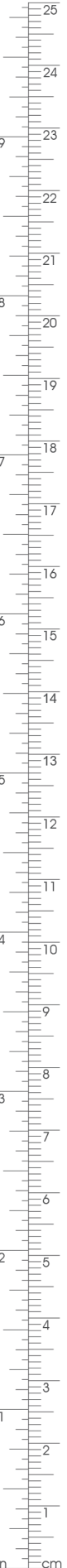

Yapışmaz/Non sticking



**EZ180-00** 0.7 mm  
16 cm  
**EZ180-01** 1.0 mm  
18.5 cm  
**EZ180-02** 1.0 mm  
20 cm

Izoleli  
Insulated



**EZ180-10** 0.7 x 23 mm  
16 cm  
**EZ180-11** 1.0 x 23 mm  
18.5 cm  
**EZ180-12** 1.0 x 23 mm  
20 cm

Izoleli  
Insulated



**EZ184-10** 1.0 mm  
21 cm

Izoleli  
Insulated

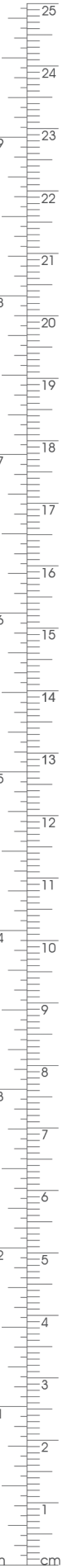

Atromatik  
Atraumatic



**EZ230-00** 18 cm  
**EZ230-01** 20 cm  
**EZ230-03** 24 cm  
**EZ230-05** 30 cm  
İzoleli/Insulated



**EZ231-00** 18 cm  
**EZ231-01** 20 cm  
**EZ231-03** 24 cm  
**EZ231-05** 30 cm  
İzoleli/Insulated  
1 x 2 diş/1 x 2 teeth





**EZ232-01** 20 cm  
**EZ232-03** 24 cm  
**EZ232-05** 30 cm  
izoleli/Insulated

Atromatik  
Atraumatic



Ø 4 mm

Ø 2.4 mm



Ø 2.4 mm **EZ017-00P**  
Ø 4.0 mm **EZ017-01P**  
Bıçak elektrotları  
Knife electrodes



Ø 2.4 mm **EZ018-00P**  
Ø 4.0 mm **EZ018-01P**  
Kesme elektrotlar  
Cutting electrodes



Ø 2.4 mm **EZ019-00P**  
Ø 4.0 mm **EZ019-01P**  
Kesme elektrotlar  
Cutting electrodes



Ø 2.4 mm **EZ020-00P**  
Ø 4.0 mm **EZ020-01P**  
Kesme elektrotlar  
Cutting electrodes



Ø 2.4 mm **EZ021-00P**  
Ø 4.0 mm **EZ021-01P**  
İğne elektrotlar  
Needle electrodes



Ø 2.4 mm **EZ022-00P**  
Ø 4.0 mm **EZ022-01P**  
Halkalı elektrotlar  
Loop electrodes

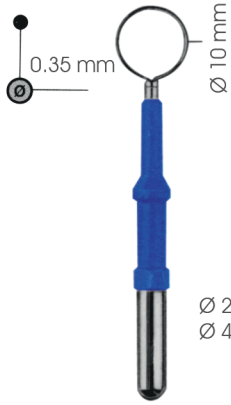

Ø 2.4 mm **EZ022-10P**  
Ø 4.0 mm **EZ022-11P**  
Halkalı elektrotlar  
Loop electrodes



Ø 2.4 mm **EZ023-00P**  
Ø 4.0 mm **EZ023-01P**  
Halkalı elektrotlar  
Loop electrodes



Ø 2.4 mm **EZ023-10P**  
Ø 4.0 mm **EZ023-11P**  
Halkalı elektrotlar  
Loop electrodes



Ø 2.4 mm **EZ024-00P**  
Ø 4.0 mm **EZ024-01P**  
Küresel elektrotlar  
Ball electrodes



Ø 2.4 mm **EZ024-10P**  
Ø 4.0 mm **EZ024-12P**  
Küresel elektrotlar  
Ball electrodes



Ø 2.4 mm **EZ026-00P**  
Ø 4.0 mm **EZ026-01P**  
Plaka elektrotlar  
Plate electrodes

Ø 4 mm

Ø 2.4 mm



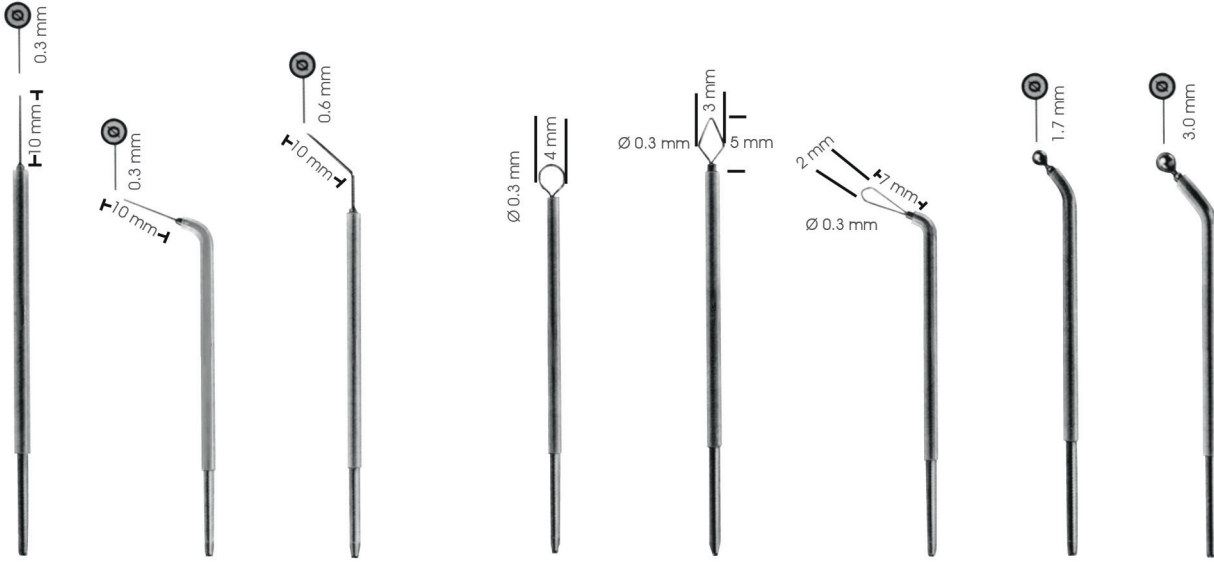

**EZ030-00** İğne elektrot Needle electrode  
**EZ032-00** İğne elektrot Needle electrode  
**EZ032-10** İğne elektrot Needle electrode  
**EZ034-00** Halkalı elektrot Loop electrode  
**EZ035-00** Halkalı elektrot Loop electrode  
**EZ036-00** Halkalı elektrot Loop electrode  
**EZ037-00** Küresel elektrot Ball electrode  
**EZ037-01** Küresel elektrot Ball electrode



**EZ097-01** Komplete/Complete  
12 adet cerrahi elektrot/Surgical lead of 12  
(EZ017-00P-EZ018-00P-EZ019-00P-EZ020-00P  
EZ021-00P-EZ022-00P-EZ022-10P-EZ023-00P  
EZ023-10P-EZ024-00P-EZ024-10P-EZ026-00P)  
1 adet konteyner (EZ096-00)/1 each container  
1 adet rak (EZ098-03)/1 adet rack

**EZ097-02** Komplete/Complete  
12 adet cerrahi elektrot/Surgical lead of 12  
(EZ017-02P-EZ018-01P-EZ019-01P-EZ020-01P  
EZ021-01P-EZ022-01P-EZ022-11P-EZ023-01P  
EZ023-11P-EZ024-01P-EZ024-12P-EZ026-01P)  
1 adet konteyner (EZ096-00)/1 each container  
1 adet rak (EZ098-03)/1 adet rack

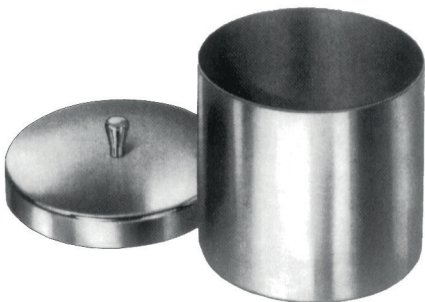

**EZ096-00**  
Kapaklı elektrot konteyneri  
Container with lid for electrodes



**EZ098-03**  
Elektrotlar için rak / "Rack for  
electrodes



**EZ001-00**  
Oval kesme elektrodu  
Cutting electrode  
Boy/Length 30 mm  
En/Wide 3.5 mm



**EZ002-00**  
Açılı kesme elektrodu  
Angled cutting electrode  
Boy/Length 14 mm  
En/Wide 1.8 mm



**EZ003-00**  
Kesme elektrodu, hassas  
Cutting electrode, delicate  
25 mm



**EZ004-00**  
Bıçak elektrod  
Knife electrode  
25 mm



**EZ005-00**  
Bıçak elektrod  
Knife electrode  
18 mm



**EZ010-00**  
Plaka elektrod  
Plate electrode



**EZ006-00**  
Halkalı elektrot  
Loop electrode  
Ø 10 mm  
Tel Ø 3 mm/Wire Ø 3 mm



**EZ009-00**  
Halkalı elektrot  
Loop electrode  
Ø 15 mm



**EZ012-00**  
Açılı halkalı elektrot  
Angled loop electrode  
Ø 8 mm



**EZ015-00** Ø 2.5 mm  
**EZ015-01** Ø 4 mm  
**EZ015-02** Ø 6 mm  
Küresel uçlu elektrotlar  
Ball point electrodes



**EZ016-00** Ø 0.3 mm  
**EZ016-01** Ø 0.5 mm  
**EZ016-02** Ø 0.7 mm  
İğne elektrotlar  
Needle electrode  
25 mm

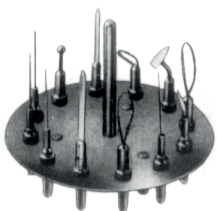

**Z 095.00** Komple/Complete  
Cerrahi elektrotlar-Surgical electrodes  
Ø 4 mm

12 Elektrotluk ray  
Rack for 12 surgical electrodes  
(Z 001.00-Z 002.00-Z 003.00-Z 004.00-Z 005.00  
Z 006.00-Z 009.00-Z 010.00-Z 012.00-Z 015.00  
Z 015.01-Z 016.00-Z 098.01)

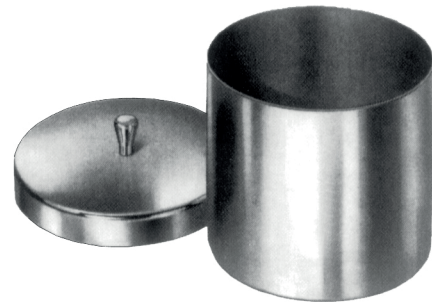

**Z 096.00**  
Kapaklı elektrot konteyneri  
Container with lid for electrodes  
25 cm  
**Z 097.00** Komple/Complete  
Z 095.00 - Z 096.00



Ø 2.4 mm

Ø 4.0 mm



**EZ052-01**  
Bıçak elektrot  
Knife electrode

**EZ052-03**  
Bıçak elektrot  
Knife electrode

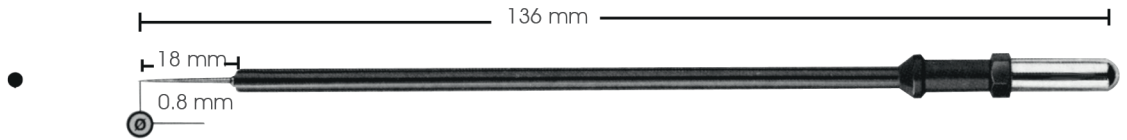

**EZ051-01**  
İğne elektrot  
Needle electrode

**EZ051-03**  
İğne elektrot  
Needle electrode

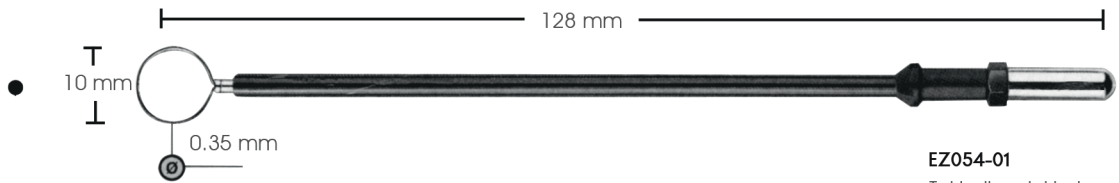

**EZ054-01**  
Tel halka elektrot  
wire loop electrode



**EZ055-01**  
Küre elektrot  
Ball electrode

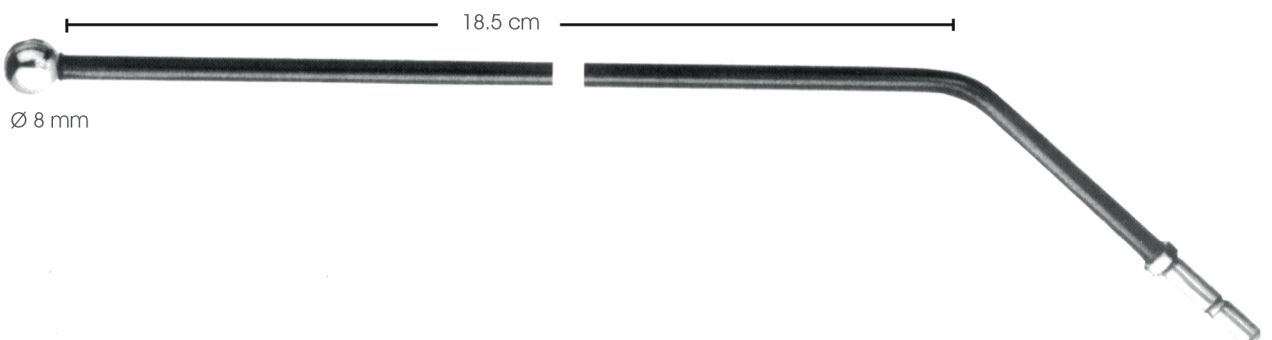

**EZ046-01**

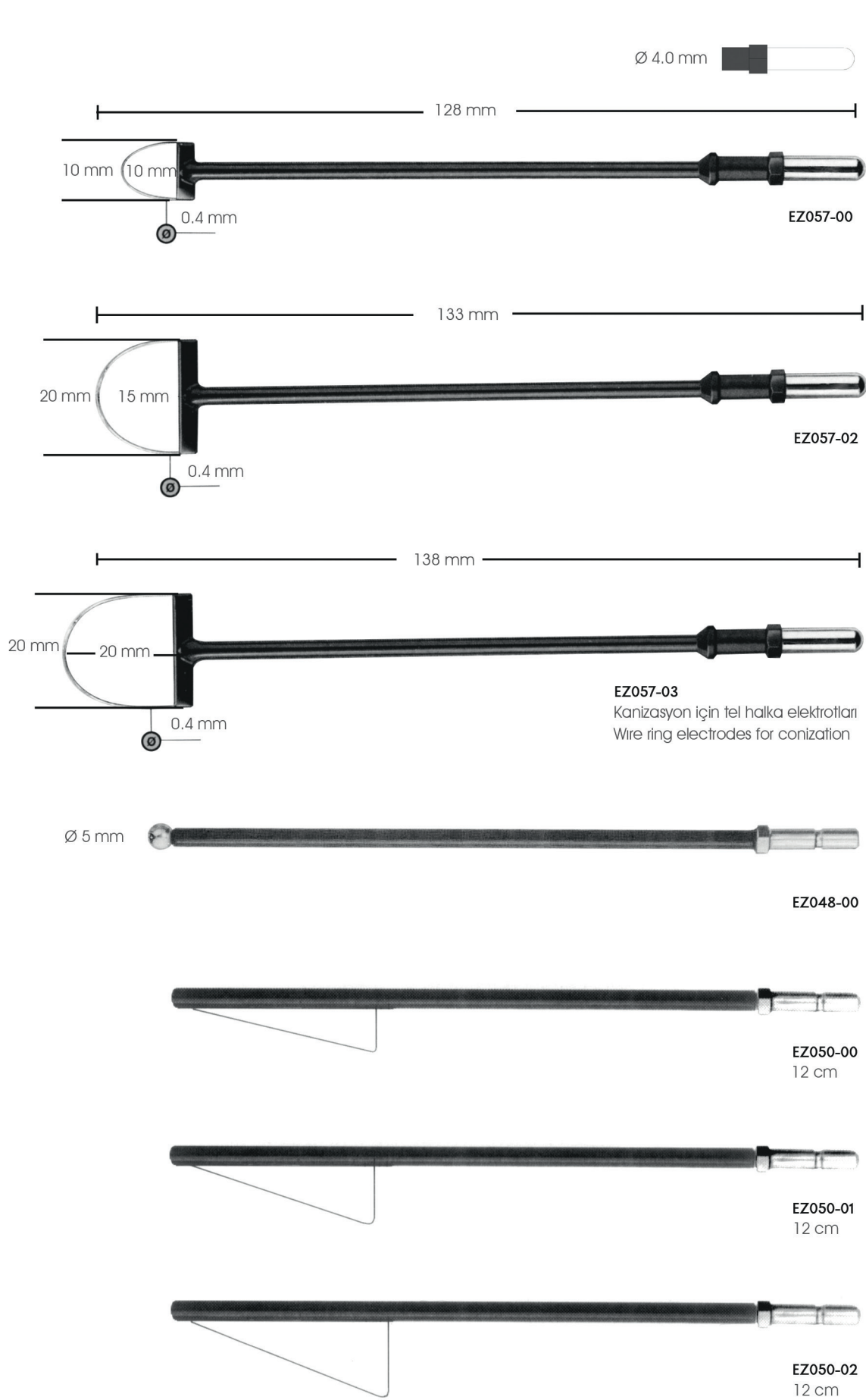

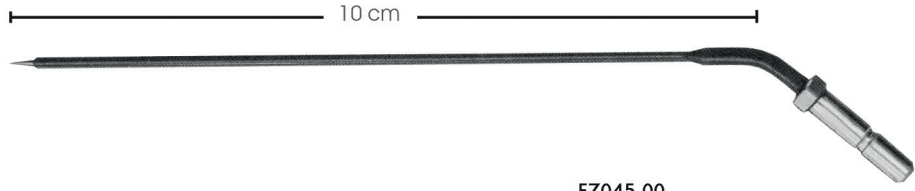

**EZ045-00**  
Burun için iğne elektrot  
Needle electrode for nasal concha



**EZ040-00**  
İğne elektrot  
Needle electrode



**EZ041-00**  
Bıçak elektrot  
Knife electrode



**EZ043-00**  
Halkalı elektrot  
Wire loop electrode



**EZ043-01**  
Halkalı elektrot  
Wire loop electrode



**EZ044-00**  
Halkalı elektrot  
Wire loop electrode  
10 x 10 mm



**EZ044-01**  
Halkalı elektrot  
Wire loop electrode  
15 x 15 mm



**EZ044-02**  
Halkalı elektrot  
Wire loop electrode  
20 x 20 mm



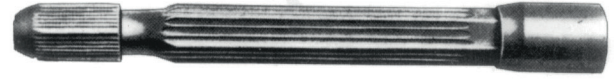

**EZ060-00**  
Elektrot tutucusu  
Electrode holder

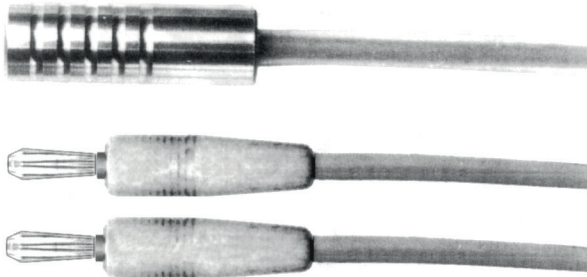

**EZ065-00**  
Bipolar kordon  
Bipolar cord  
2 mt.

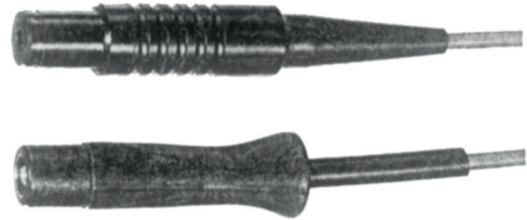

**EZ309-00**  
Ayrılabilir aletler için kablo  
Instrument cable for detachable

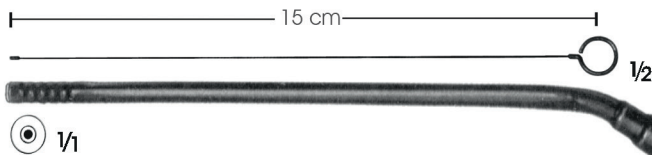

LANDOLT  
**EJ620-00** İzoleli/Insulated  
Pihiti emiş kanülü, mandrenli ve stoplu Ø 5 mm  
143° buhar sterilizatörlerinde steril edilebilir.  
Coagulation suction cannula  
with interruptor and mandrel Ø 5 mm  
Can be sterilized in a steam sterilizer up to 143°

Vakum hortumu için bağlantı  
Connection for suction hose

Çap/Olive  
Ø 7.5-12 mm

HF elektrotları tarafından dokunulmuş,  
lekelenmemiş bağlantı Ø 4 mm  
HF-Elektrot kolu Ø 4 mm  
Untarnished contact to be  
touched by HF-electrodes Ø 4 mm

1/2



