

EP

Kemik Pensleri, Ronjurları, Makasları ve Pançları
Bone Holding Forceps, Rongeurs, Scissors and Punches

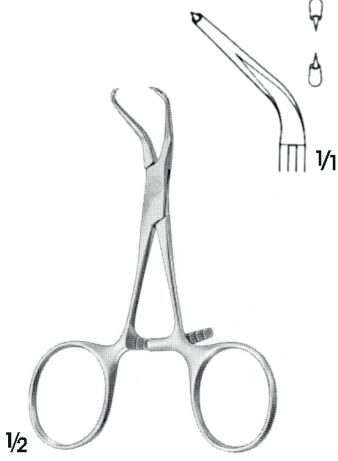



EP100-00
Setli, pozisyon pensi
Reposition forceps with
stepped tips
9.5 cm

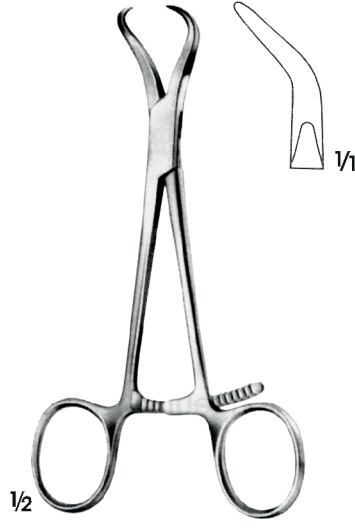

EP102-00
Küçük parçaları
konumlandırma pensi
Reposition forceps for small
fragments
13.5 cm

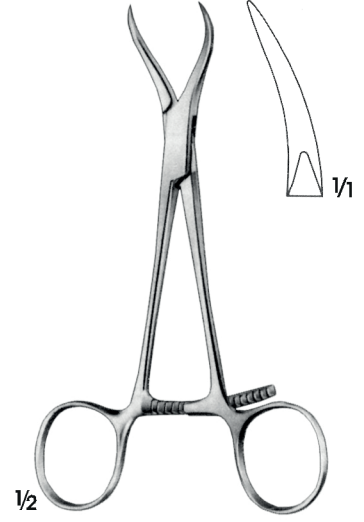

EP103-00
Çene kemiğine ait
konumlandırma pensi
Reposition forceps, especially
for maxillary reposition
13.5 cm

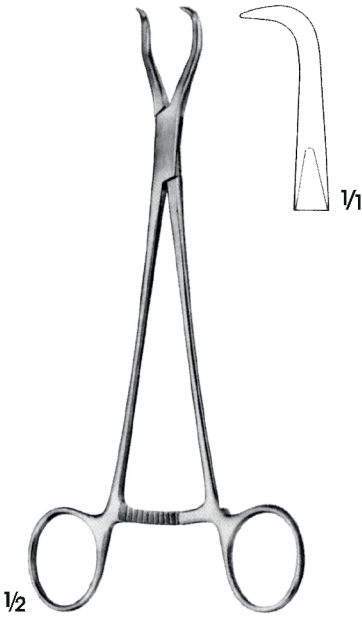

HAASE
EP105-00
Pozisyon pensi, çeneye ait
kırıklar için
Reposition forceps for
mandibular fractures
16.5 cm

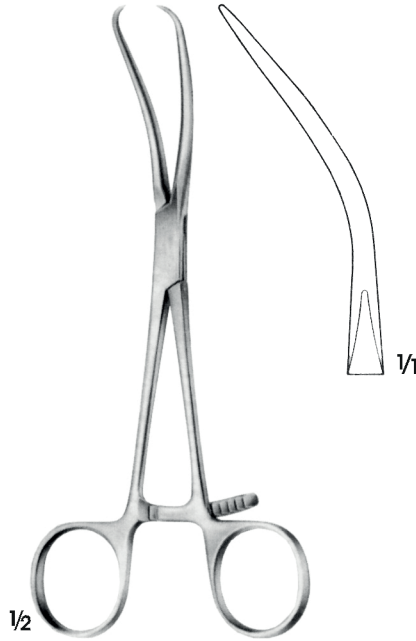

REILL
EP106-00
Pozisyon pensi
Reposition forceps
17 cm



EP107-01
Pozisyon pensi
Reposition forceps
20.5 cm



1/2

FÖRSTNER
EP120-01
14 cm



1/2

EP123-00
13.5 cm



1/2

HAASE
EP124-00
14 cm

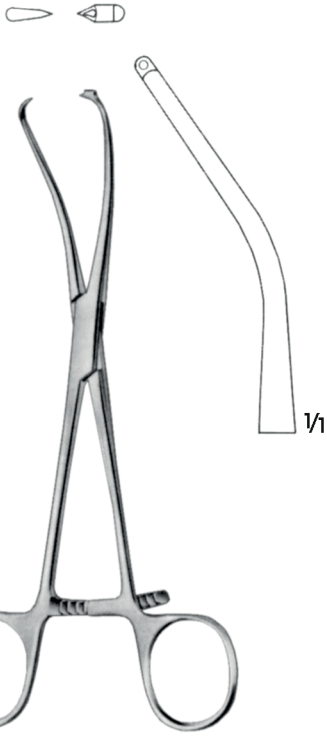

1/2

MEYER
EP110-00
Kışner telleri için matkap kılavuzu,
yeniden konumlandırıcı
Reposition forceps for fingers,
with drill guide for KIRSCHNER
kullanılan tel Ø 1.0 mm
For wires with Ø 1.0 mm
17 cm

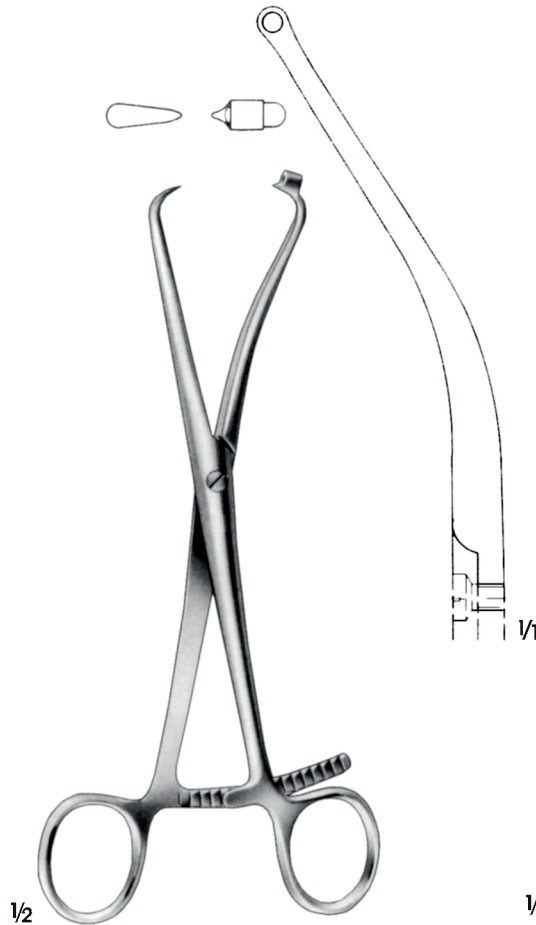

1/2

MEYER
EP112-00
Kışner telleri için matkap kılavuzu,
yeniden konumlandırıcı
Reposition forceps for fingers,
with drill guide for KIRSCHNER
kullanılan tel Ø 2.0 mm
For wires with Ø 2.0 mm
20.5 cm

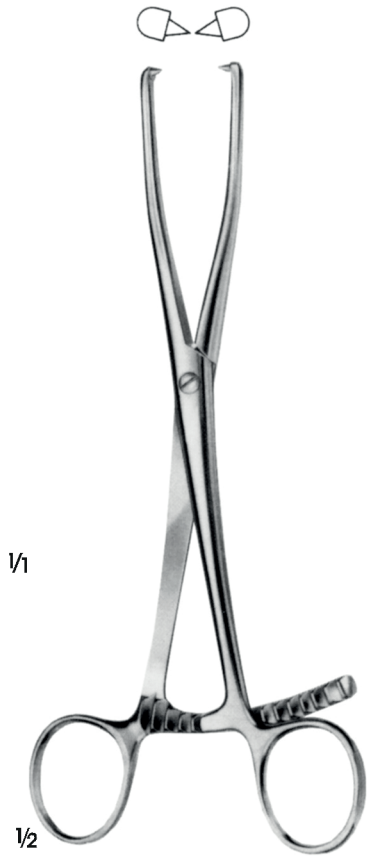

1/2

EP113-00
Malleolus pens
Malleolar forceps
21 cm



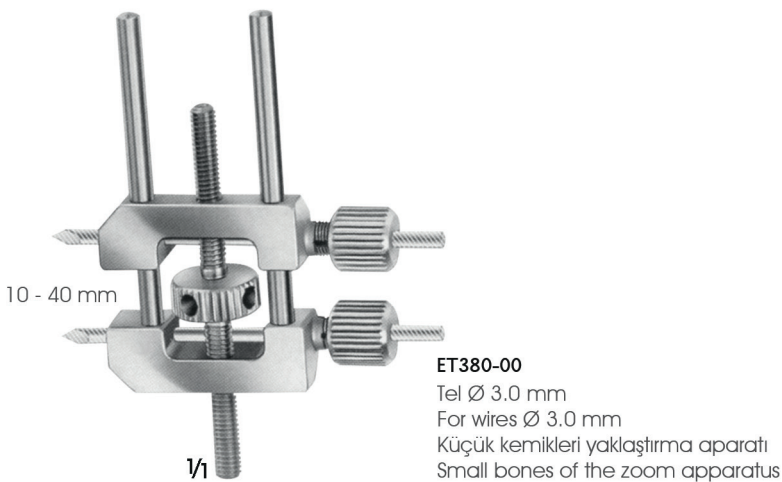
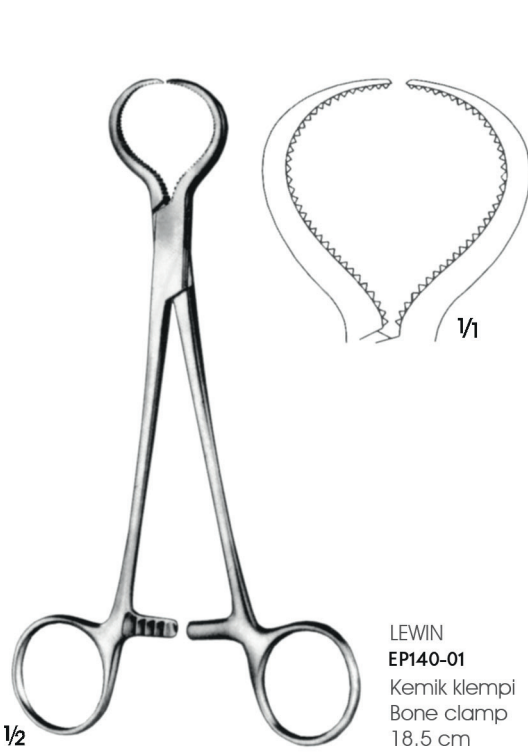

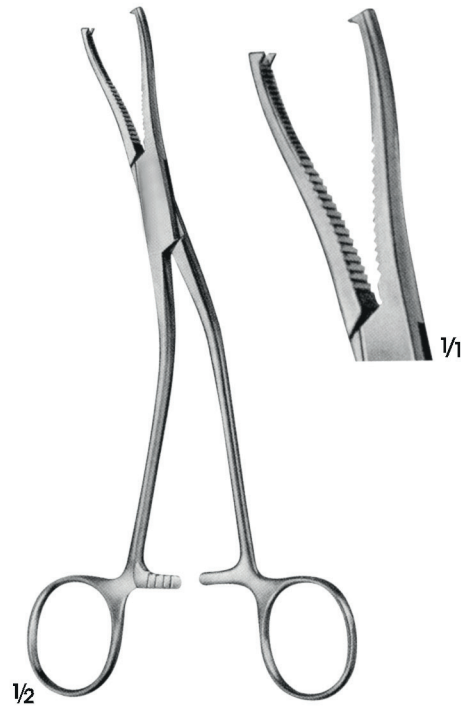



1/2

EP142-00
Kilitlenebilir, sabitlenebilir pens
Forceps with ratchet fixation
14 cm



1/2

EP143-00
Vida ile sabitlenebilir pens
Forceps with thread fixation
17 cm



1/2

EP143-01
Vida ile sabitlenebilir pens
Forceps with thread fixation
23.5 cm



1/2

EP150-00
Kemik tutma pens
Bone holding forceps
20 cm



1/2

LANGENBECK
EP151-00
Kemik tutma pens
Bone holding forceps
20.5 cm



1/2

FERGUSON
EP152-00
Kemik tutma pens
Bone holding forceps
20.5 cm

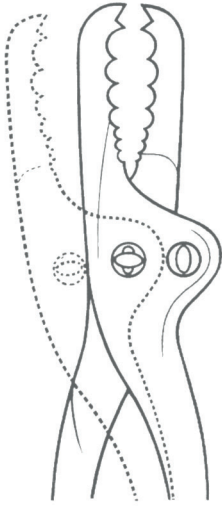

Ayarlanabilir ağız
Jaw adjustable



FARABEU
EP155-00
23cm



FARABEU
EP155-01
25.5 cm



FARABEU-LAMBOTTE
EP156-01
25.5 cm



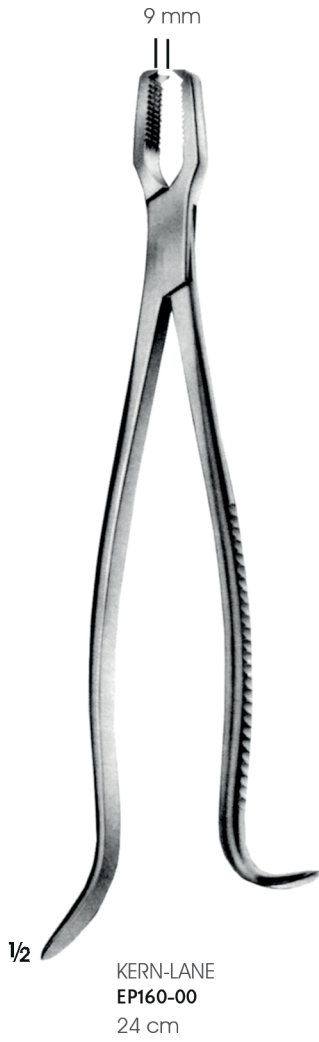





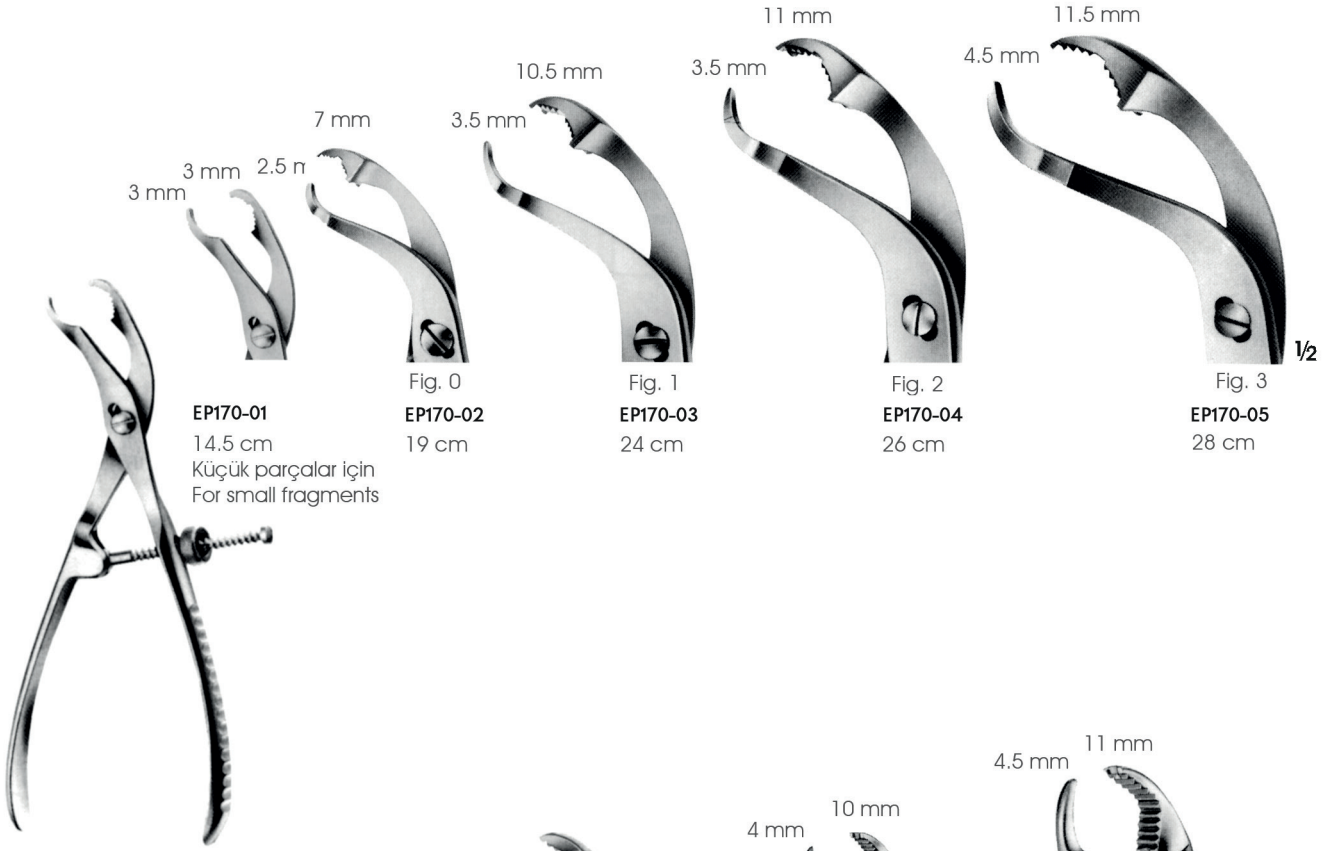

EP170-01
14.5 cm
Küçük parçalar için
For small fragments

Fig. 0
EP170-02
19 cm

Fig. 1
EP170-03
24 cm

Fig. 2
EP170-04
26 cm

Fig. 3
EP170-05
28 cm

EP170-01-EP170-05
Kendi kendini merkezleyici,
vidalı sabit pensler
Self-centering forceps with
thread fixation



VERBRUGGE
EP171-00
17.5 cm



VERBRUGGE
EP172-01-EP172-03
Eklemlü ağız/With lip joint

Fig. 1
EP172-01
25.5 cm

Fig. 2
EP172-02
26.5 cm

Fig. 3
EP172-03
27 cm



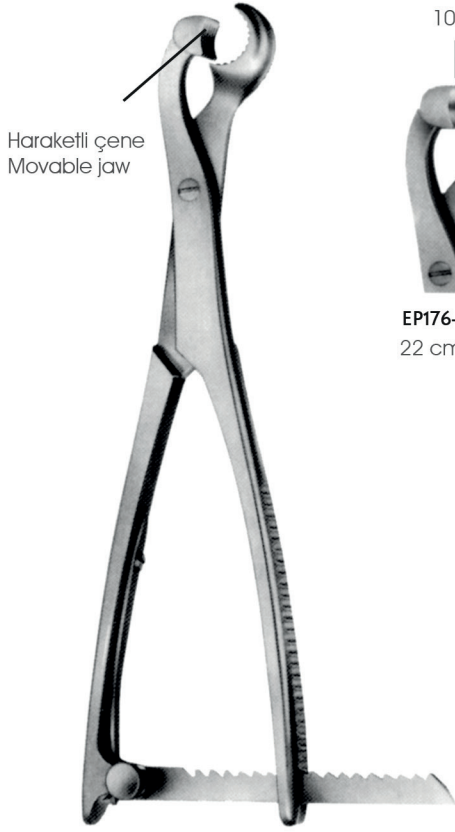

EP176-01
22 cm



EP176-02
26 cm



EP176-03
33 cm

LAMBOTTE
EP176-01-EP176-03



Haraketli çene
Movable jaw



EP177-00
21.5 cm

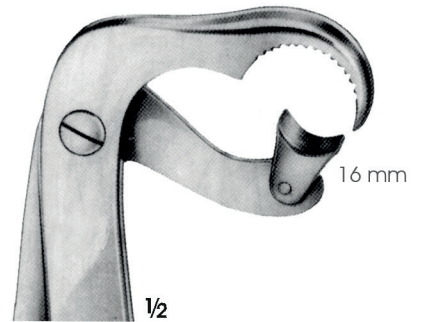

EP178-00
27.5 cm

EP177-00-EP178-00



LOWMAN
EP180-00 17 cm
EP180-01 20.5 cm



1/2
LOWMAN-GERSTER
EP180-02
21 cm



1/2
LOWMAN-HOGLUND
EP183-00
17.5 cm

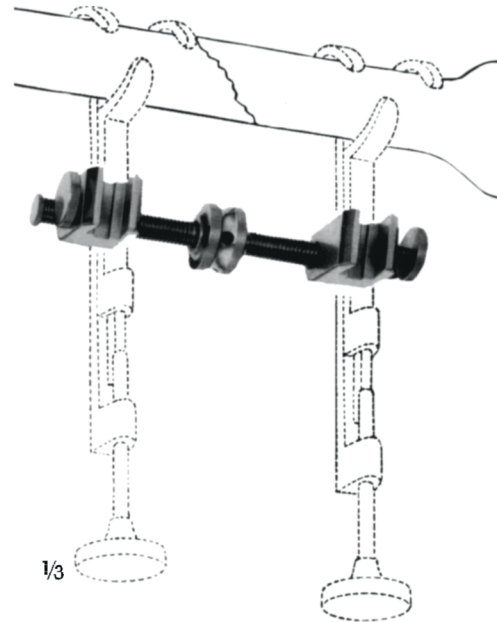

1/3
GERSTER
EP185-00
EP180-00-EP183-00 için çekirme çubuğu
Traction bar for P EP180-00-EP183-00





EP251-01
Sinovektomi ronjur
Synovectomy rongeur
Çene genişliği 2.0 mm
Width of jaws 2.0 mm
13 cm



STELLBRINK
EP260-01
Sinovektomi ronjur
Synovectomy rongeur
17.5 cm

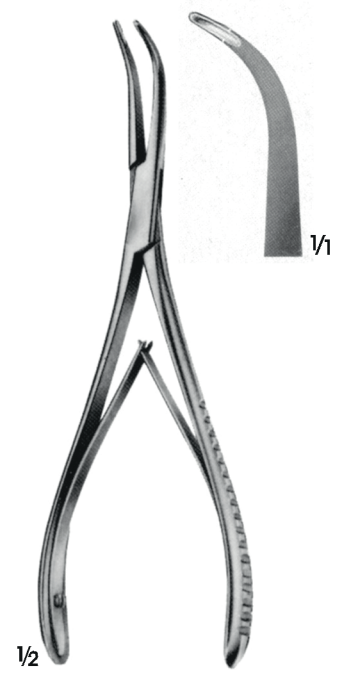

STELLBRINK
EP260-02
Sinovektomi ronjur
Synovectomy rongeur
17 cm

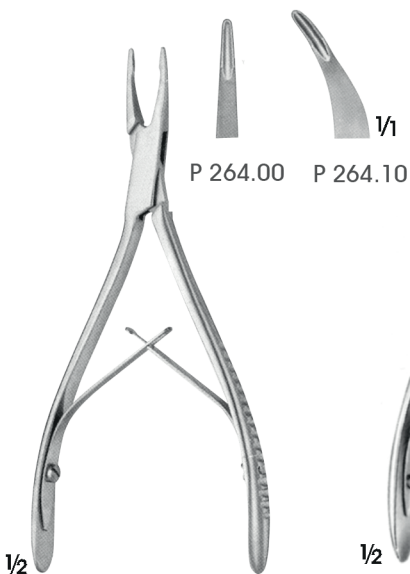

FRIEDMANN
EP264-00-EP264-10
Kemik Ronjur/Bone Ronjur
14 cm

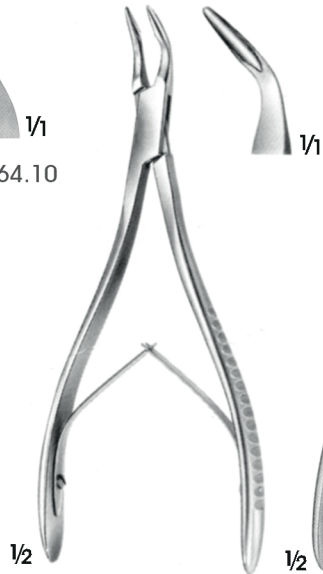

STELLBRINK
EP272-01
Kemik Ronjur/Bone Ronjur
15 cm

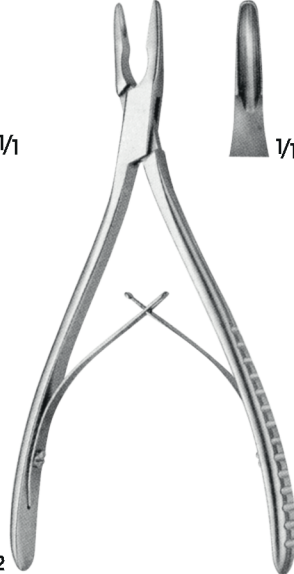

LEMBERT
EP274-01
Kemik Ronjur/Bone Ronjur
16.5 cm



SCHWARZ
EP292-01
Kemik Ronjur/Bone Ronjur
14.5 cm



JANSEN
EP277-00
17.5 cm



JANSEN
EP278-00
17.5 cm

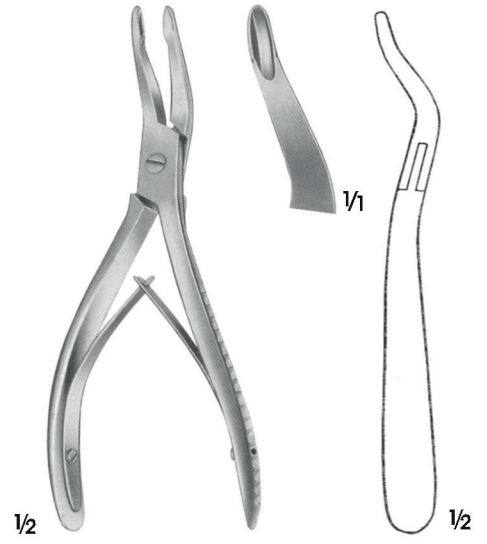

ALEXANDER
EP280-00
14 cm



LEMPERT
EP286-00-EP287-00
20 cm

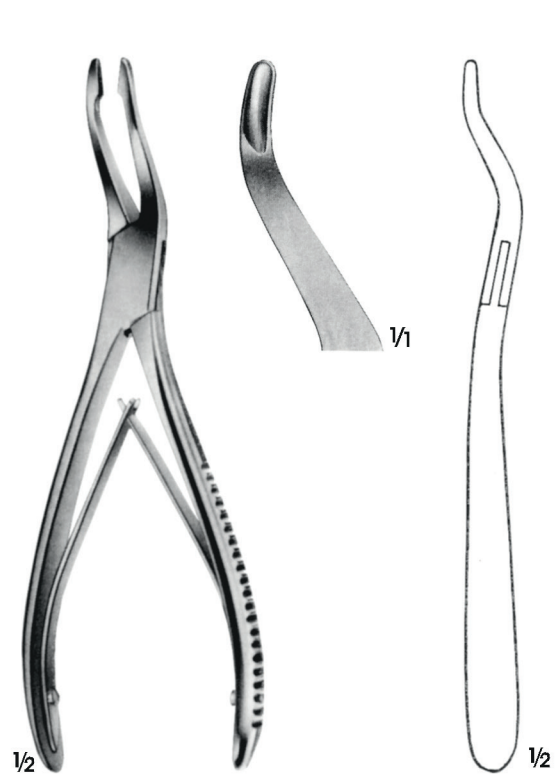

JANSEN
EP282-00
19 cm



BEYER
EP285-00
18 cm



LUER
EP290-00-EP291-00
17.5 cm

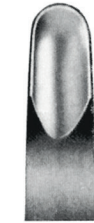

EP290-00



EP291-00



BANE-HARTMANN
EP279-00
17.5 cm

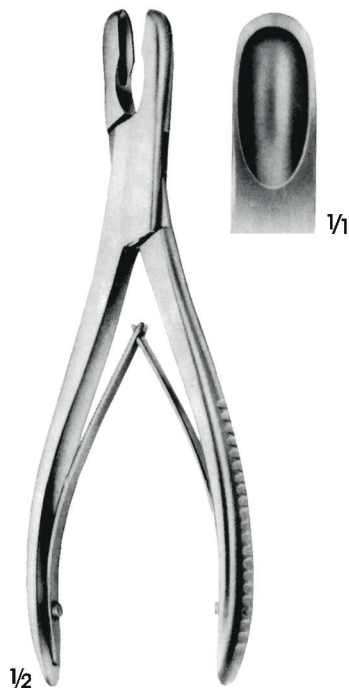

LUER
EP295-00
18 cm

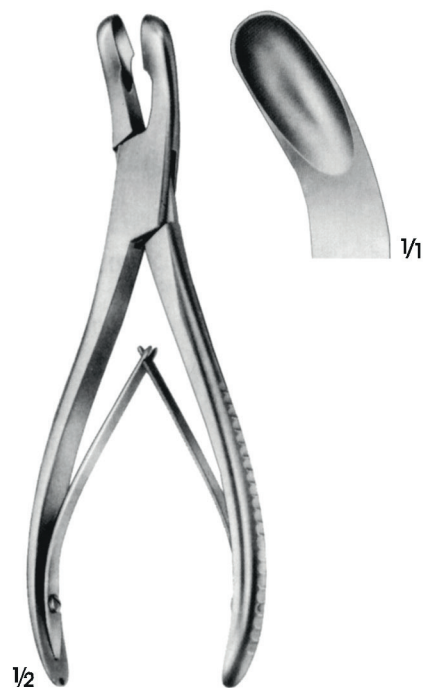

LUER
EP296-00
18 cm



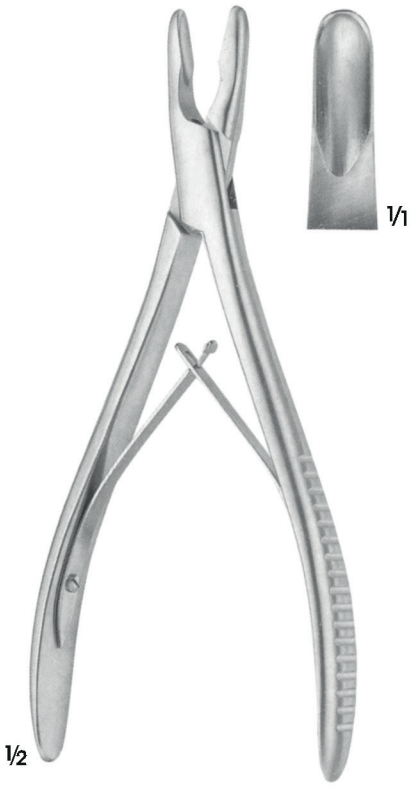

ADSON
EP323-01
20 cm



NORTHFIELD
EP329-01
21 cm

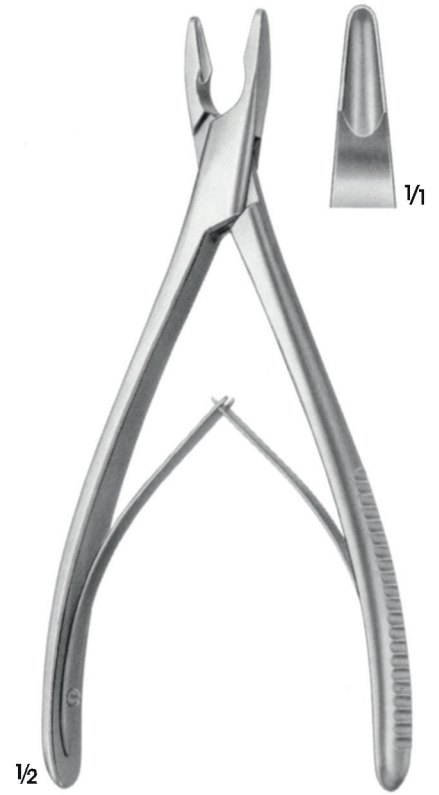

PENNYBACKER
EP327-01
20.5 cm



TROTTER
EP299-00
20.5 cm



GULEKE
EP298-00
20.5 cm

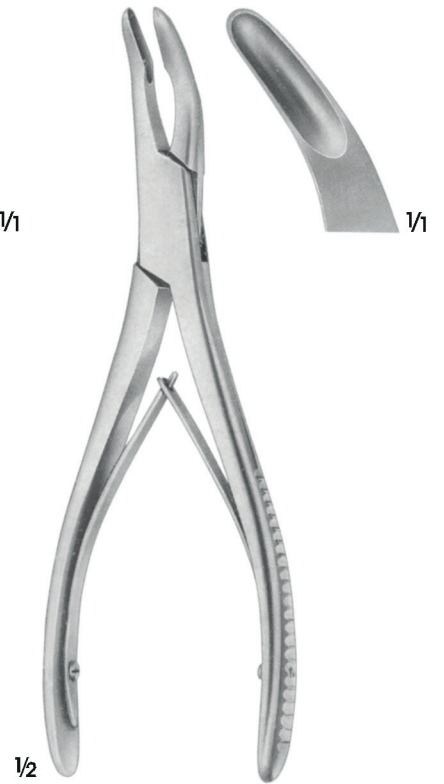

OLIVECRONA
EP297-00
20.5 cm



BÖHLER
EP300-00-EP300-01
15.5 cm



MAYFIELD
EP304-01
17.5 cm

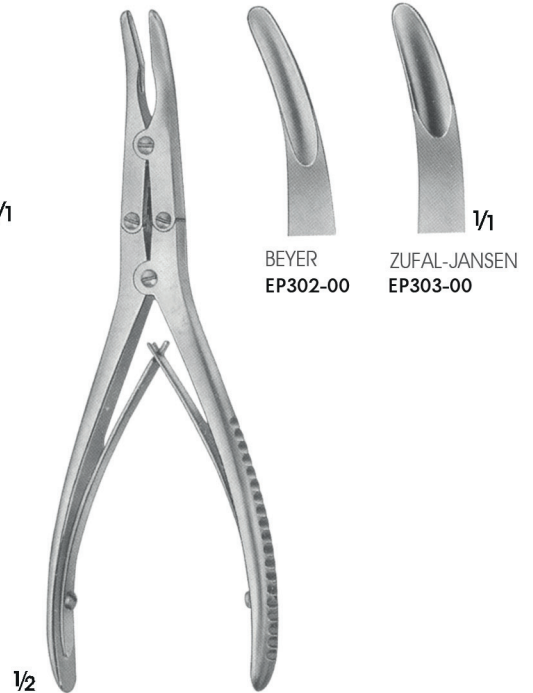

BEYER
EP302-00
ZUFAL-JANSEN
EP303-00
18 cm



RUSKIN
EP308-01
19 cm



MARQUARDT
EP306-01
20 cm



RÖTTGEN-RUSKIN
EP309-01
24 cm



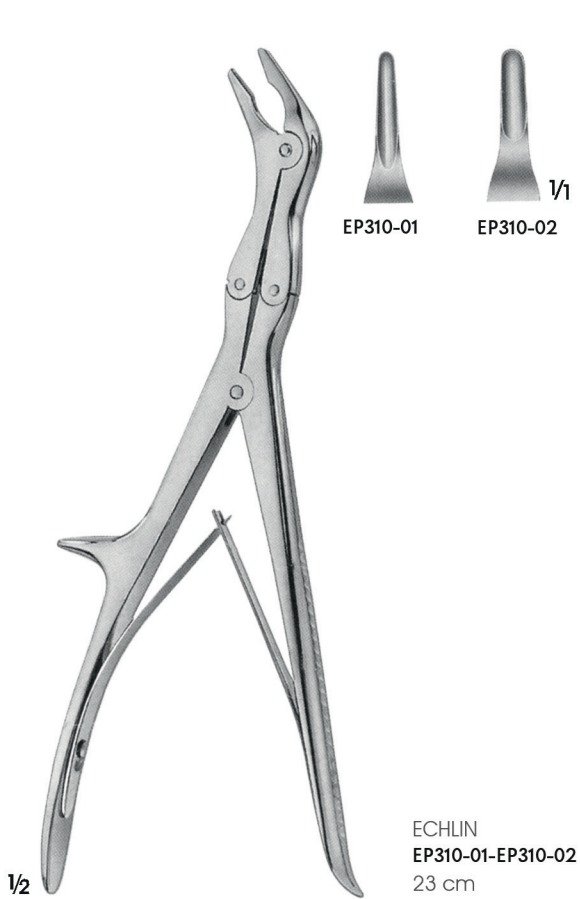
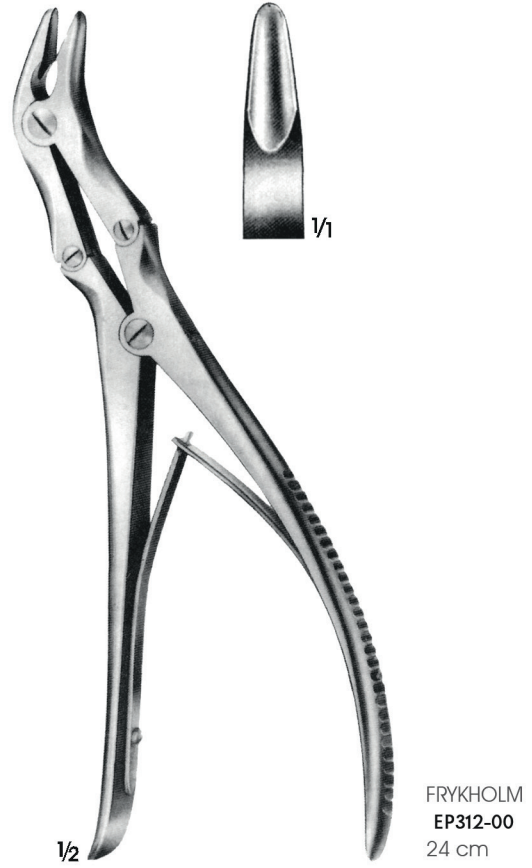



LEKSELL-STILLE
EP316-01
24 cm



STILLE-RUSKIN
EP318-01
24 cm



LUER-STILLE
EP320-01
22.5 cm

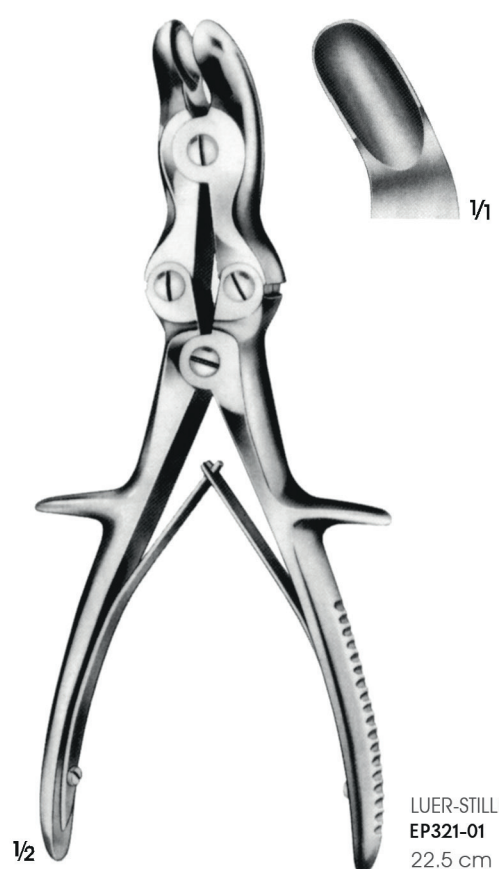

LUER-STILLE
EP321-01
22.5 cm



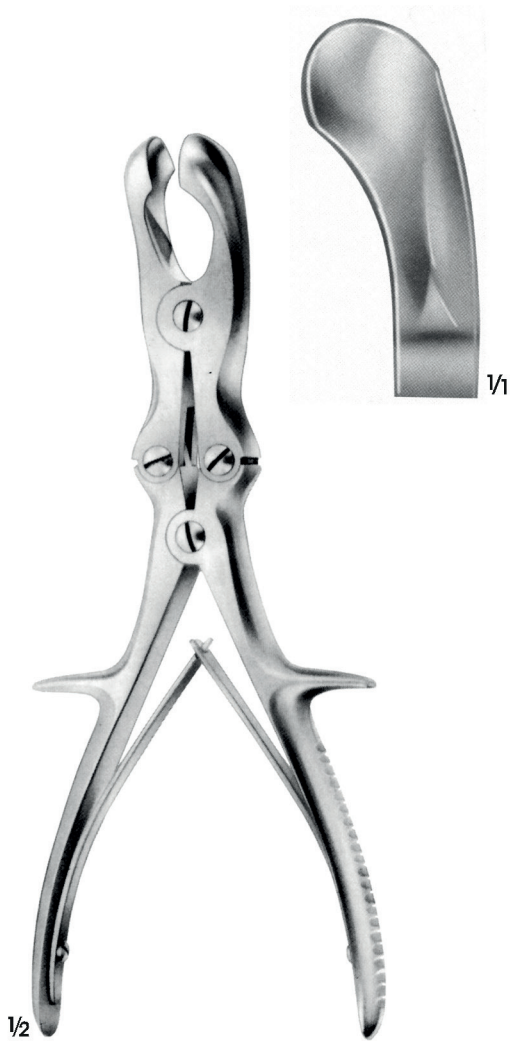

SEMBO
EP325-01
24 cm



LUER-STILLE
EP325-01
27 cm

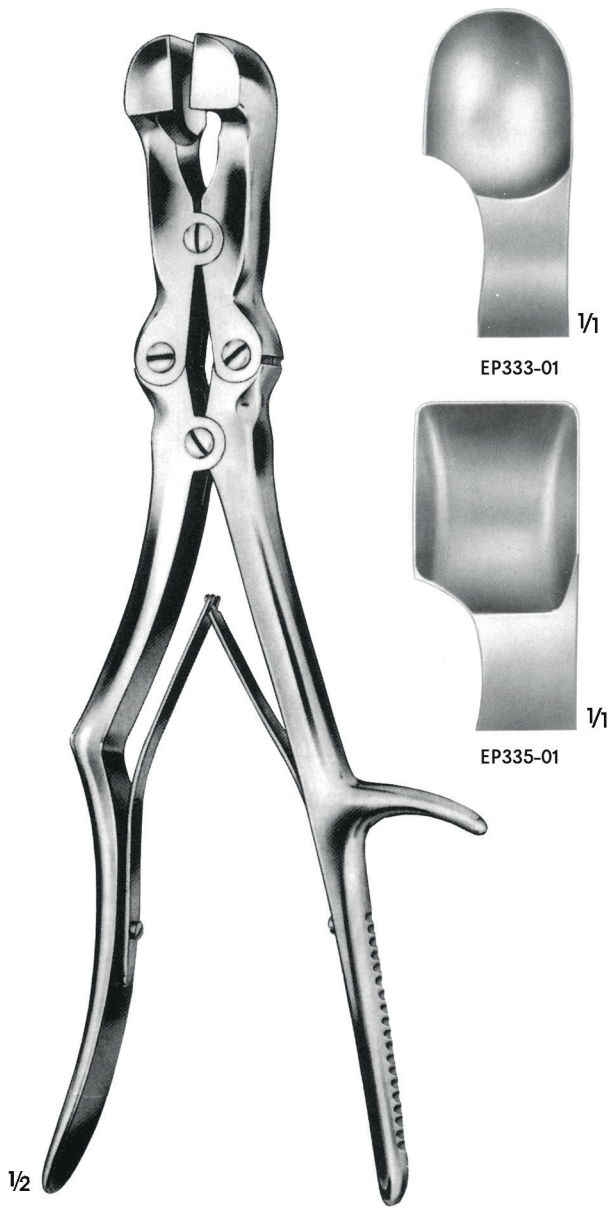

SAUERBRUCH-CORYLLOS
EP333-01-EP335-01
31 cm



SYPERT
EP338-02
36 cm



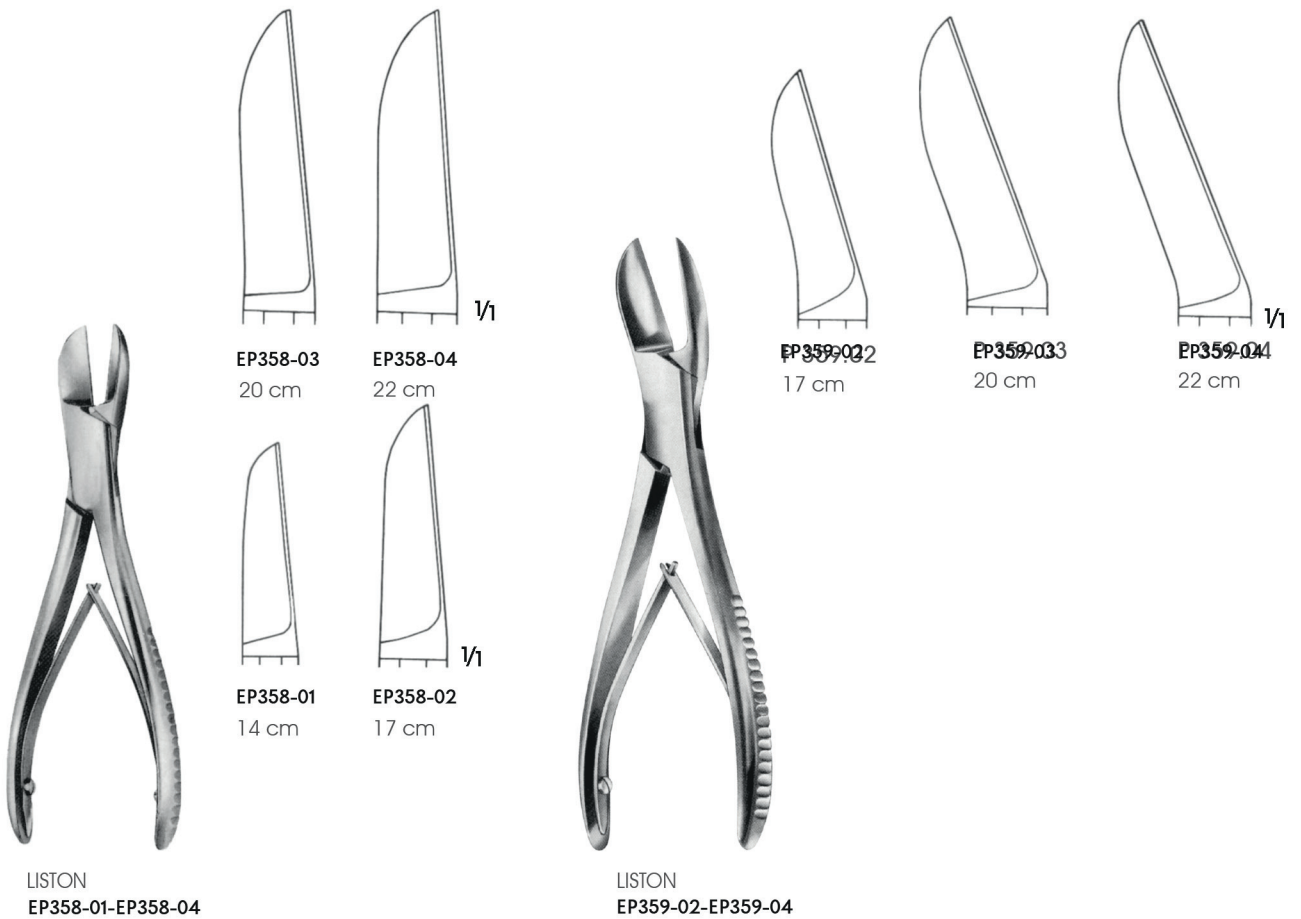
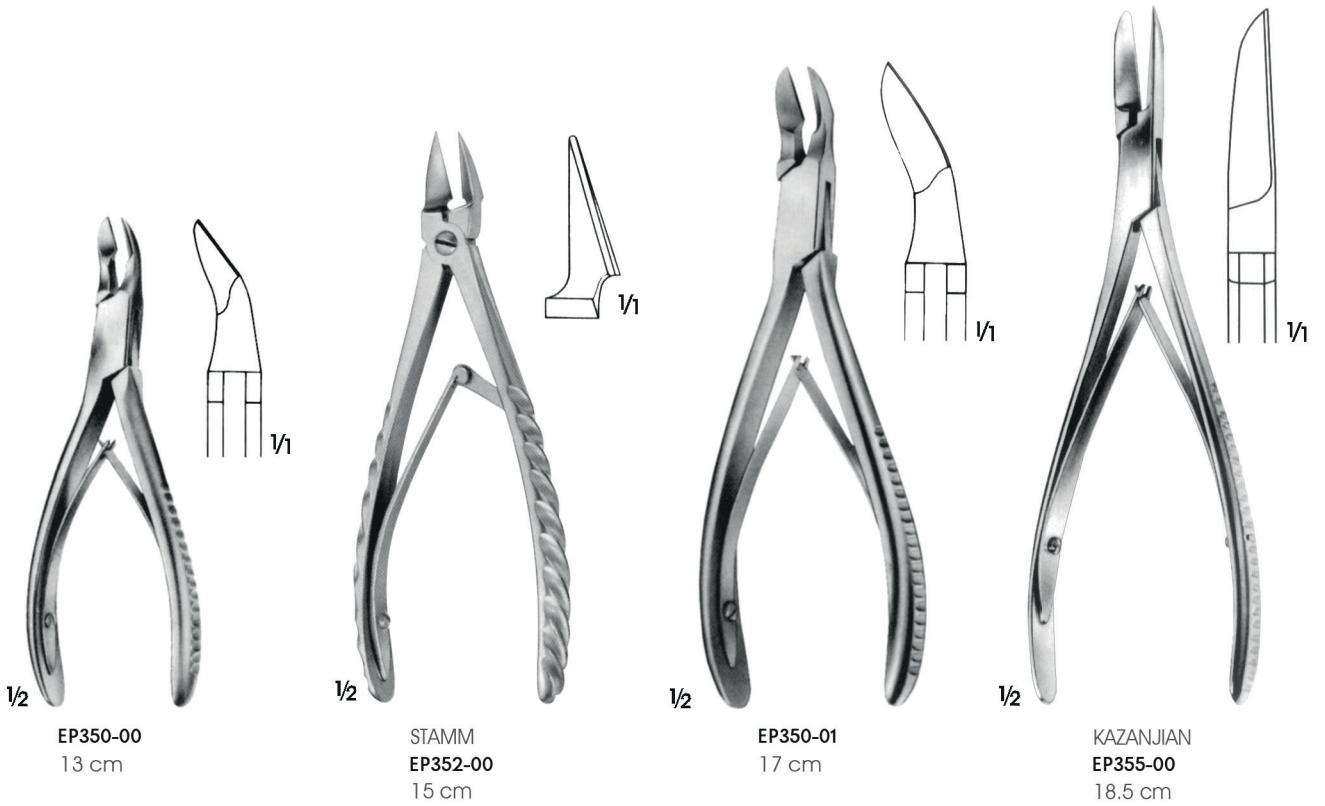



1/2

BÖHLER
EP365-00
14.5 cm



1/2

BÖHLER
EP366-00
14.5 cm

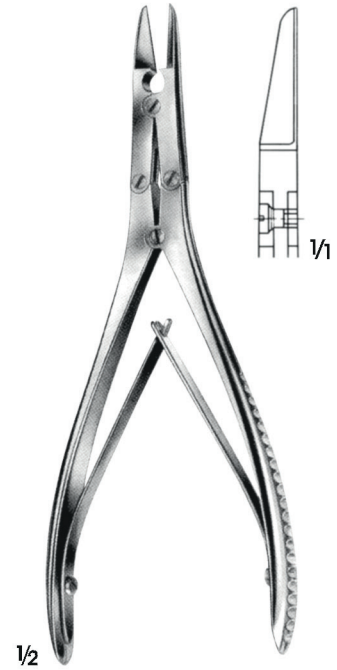

1/2

EP367-00
17 cm



1/2

MC INDOE
EP368-00
17.5 cm



1/2

RUSKIN-LISTON
EP370-00
19 cm

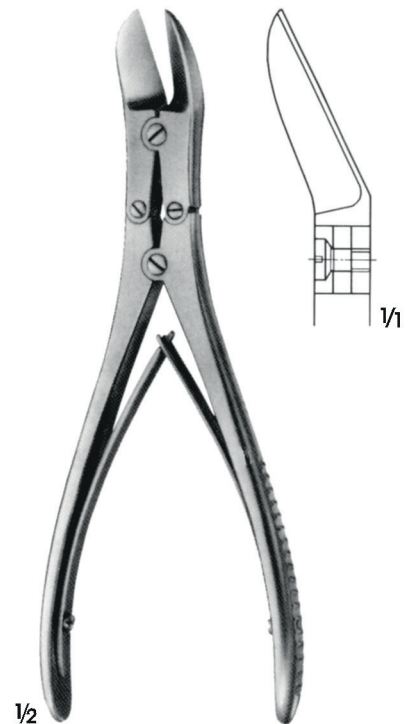

1/2

RUSKIN-LISTON
EP371-00
19 cm



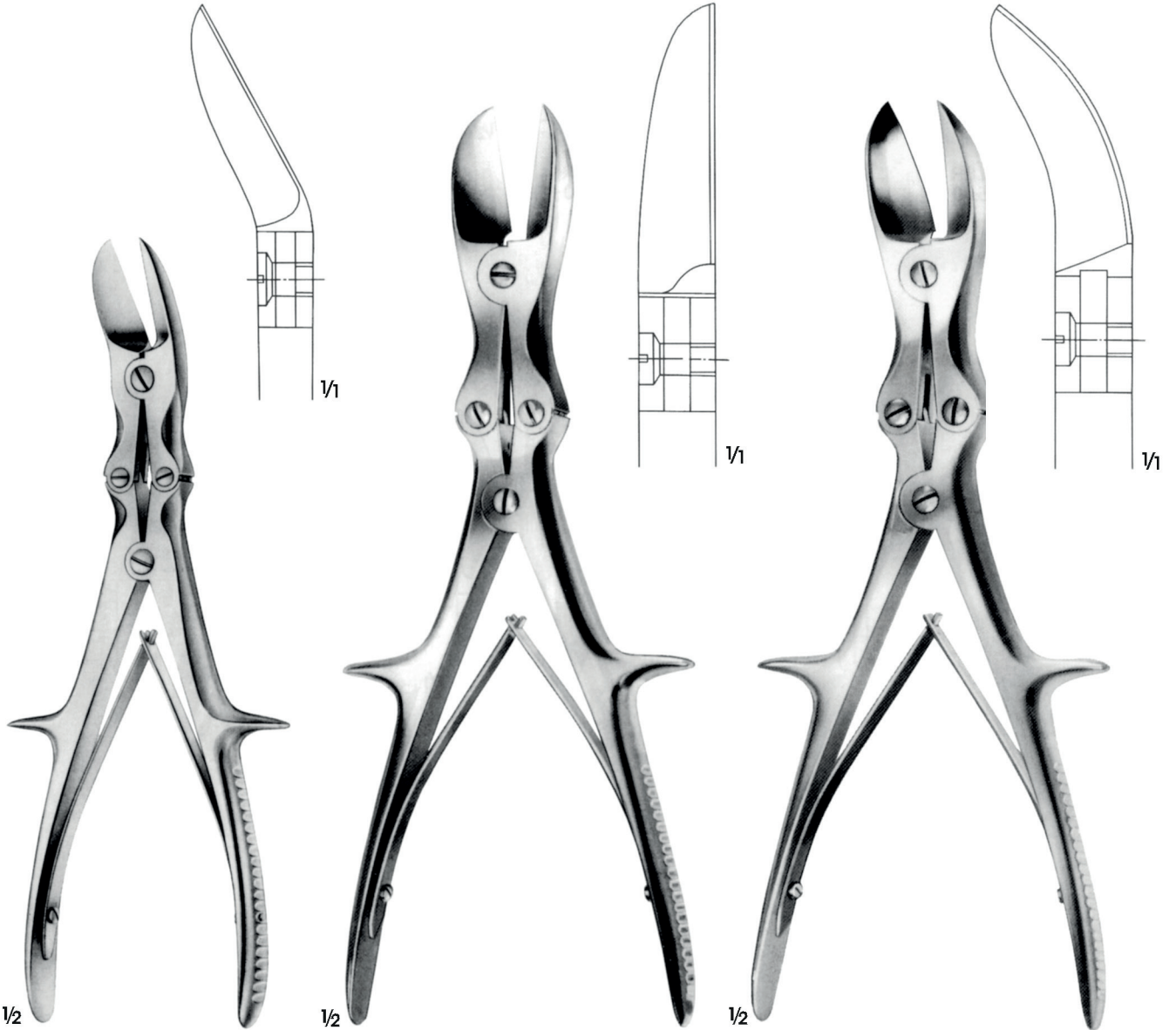

LISTON
EP375-01
Düz eğimli/Curved on flat
24 cm

LISTON
EP376-01
Düz/Straight
28 cm

LISTON
EP377-01
Düz eğimli/Curved on flat
28 cm

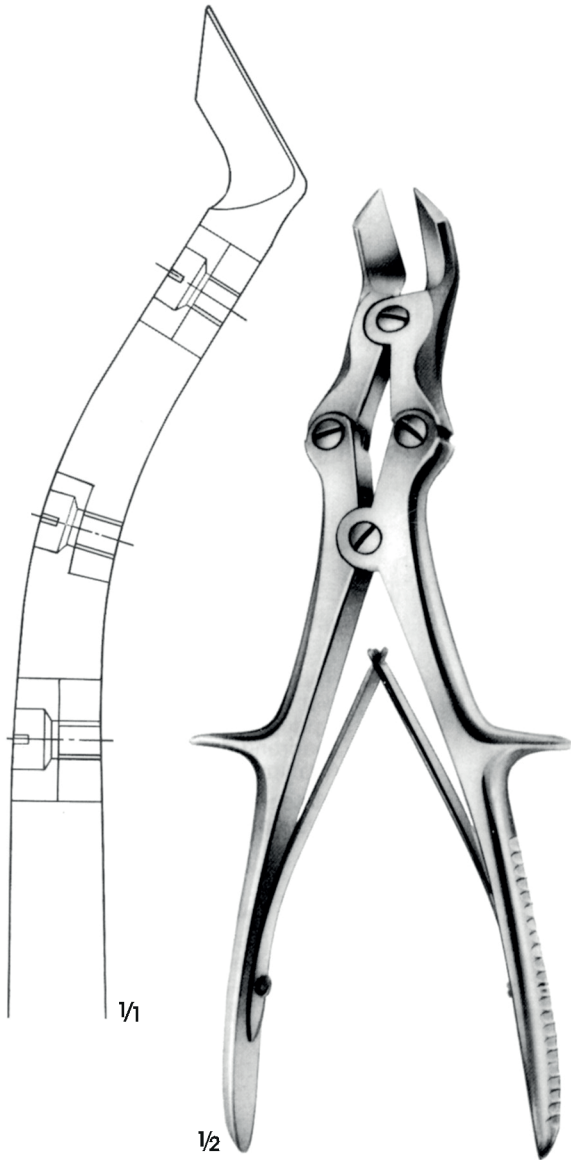

LISTON-KEY-HORSLEY
EP379-01
25.5 cm

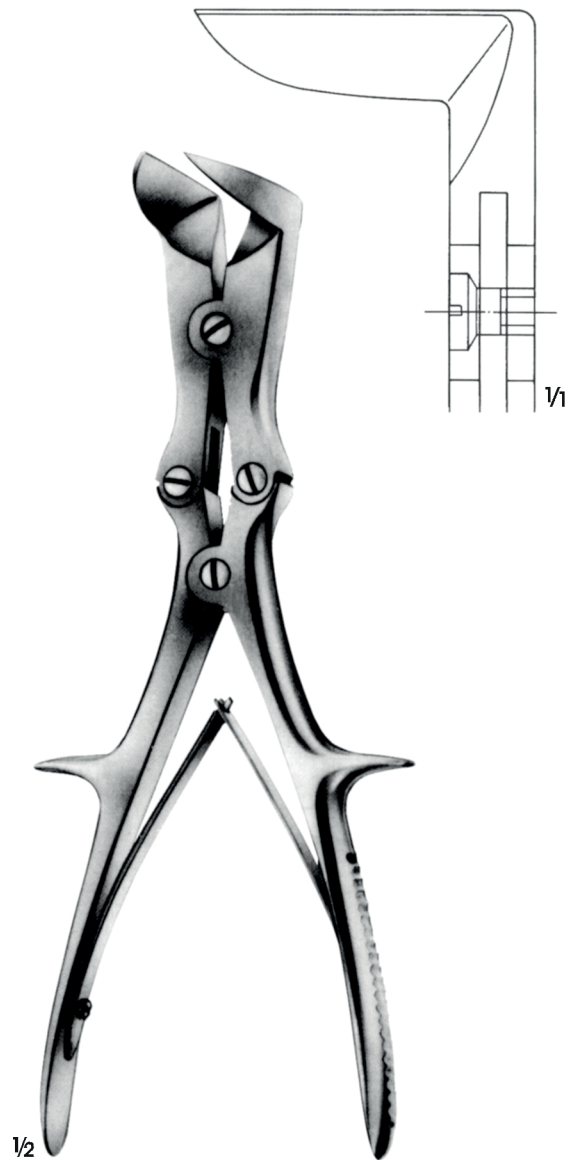

LISTON-STILLE
EP378-01
26.5 cm



Pançlar için açılı pozisyonlar
Angled positions for punches

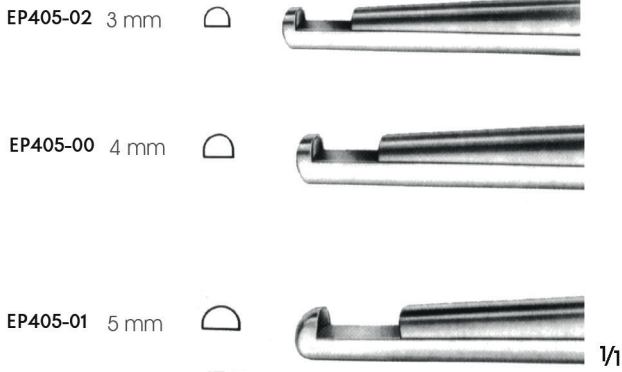
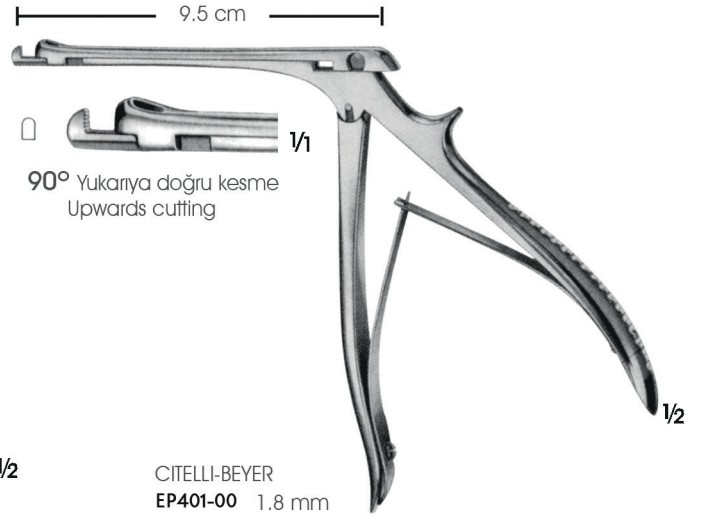
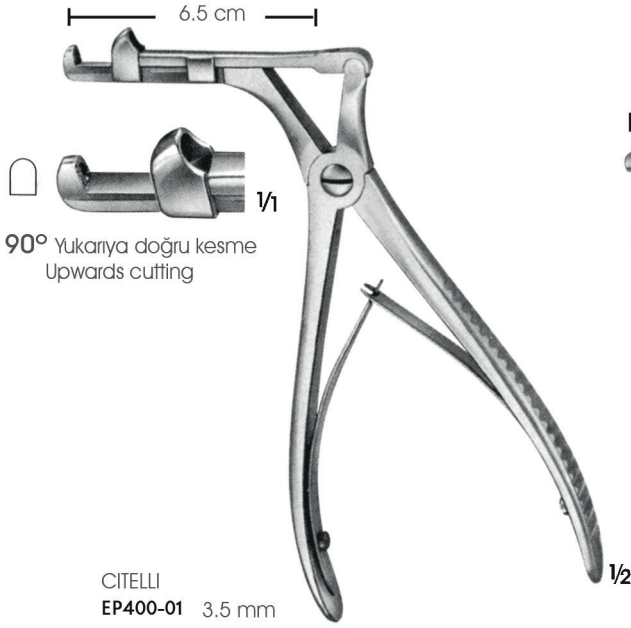
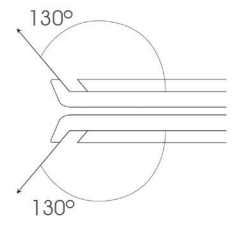
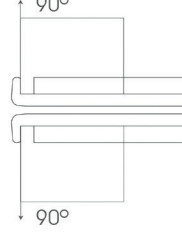
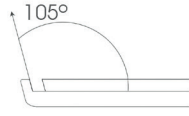

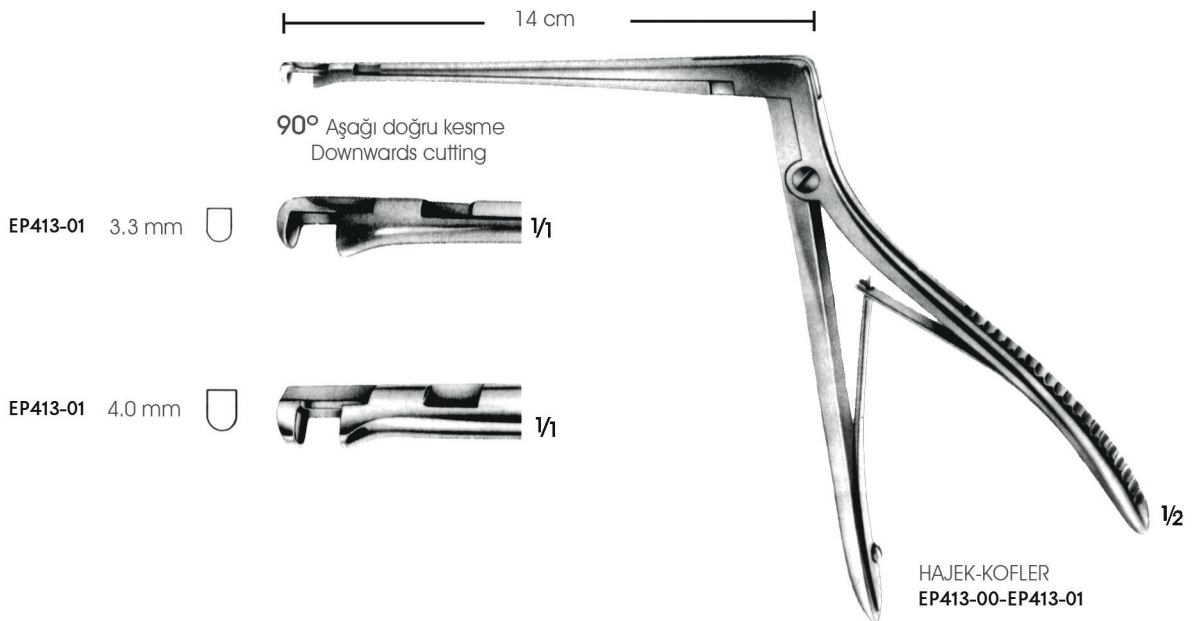
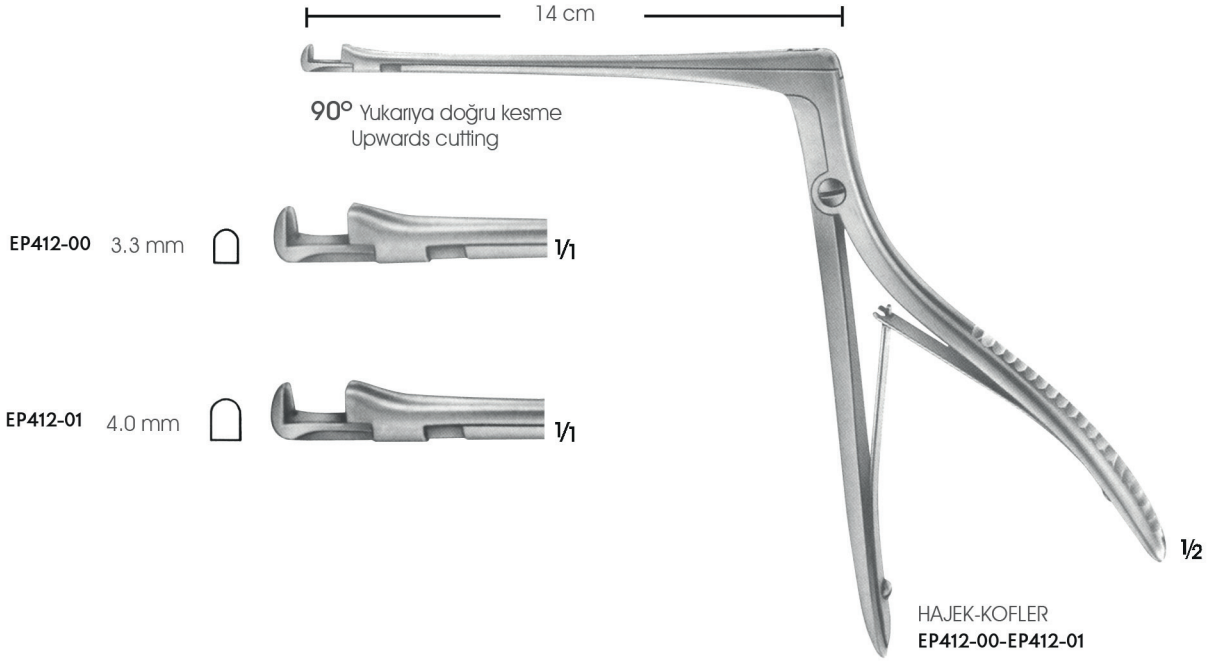

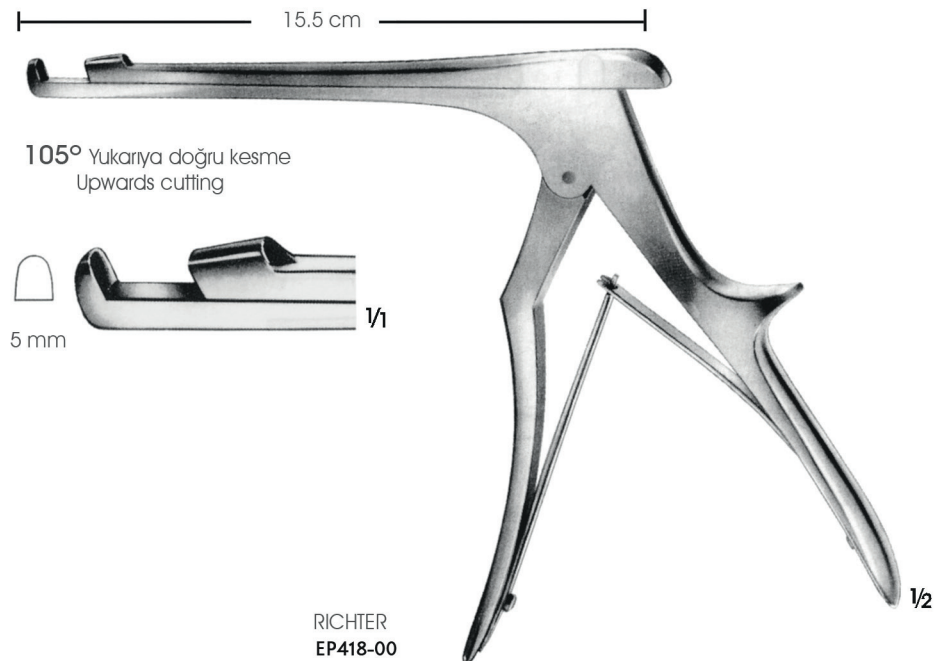
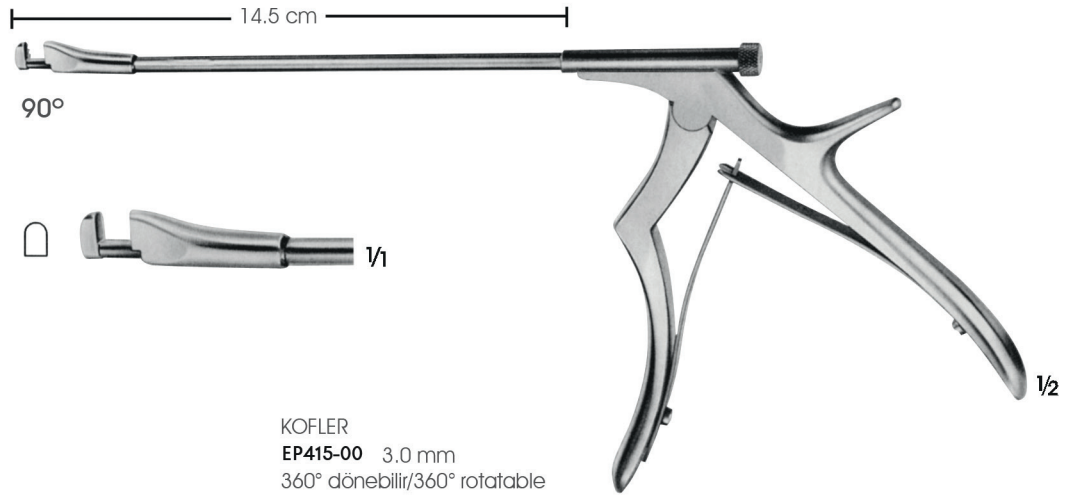
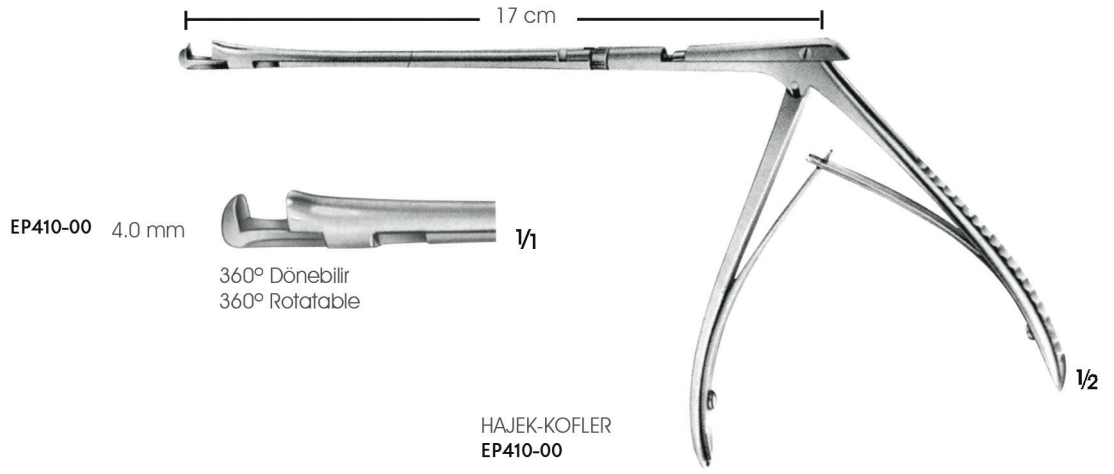

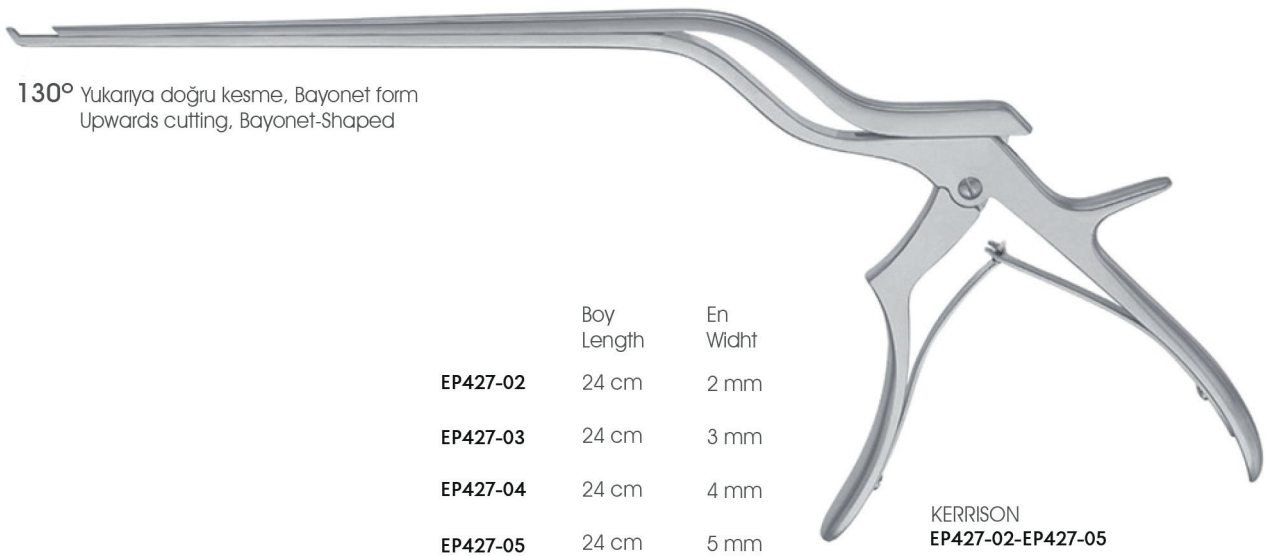
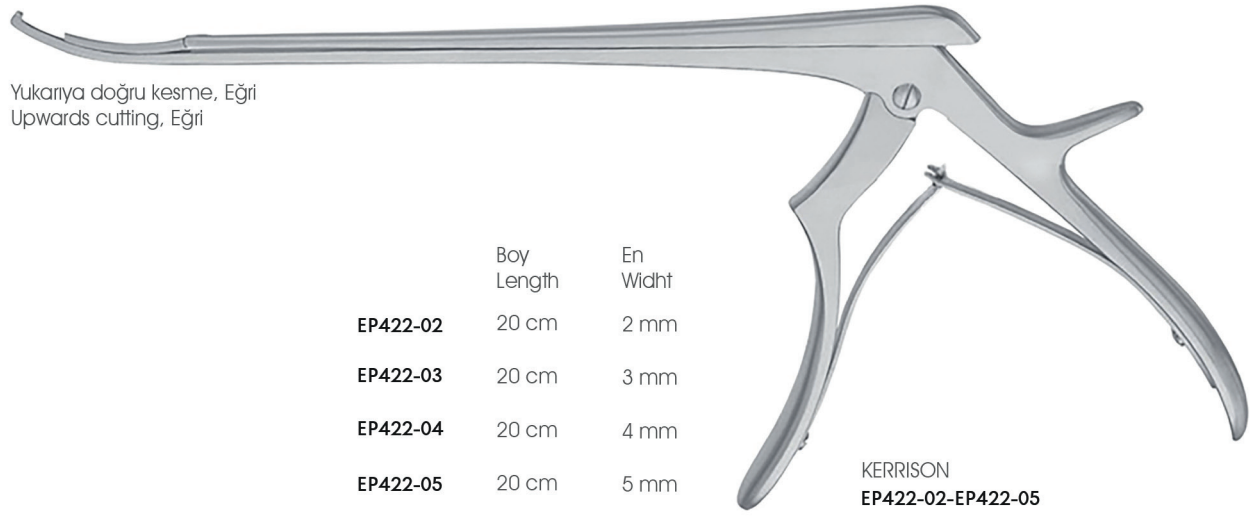
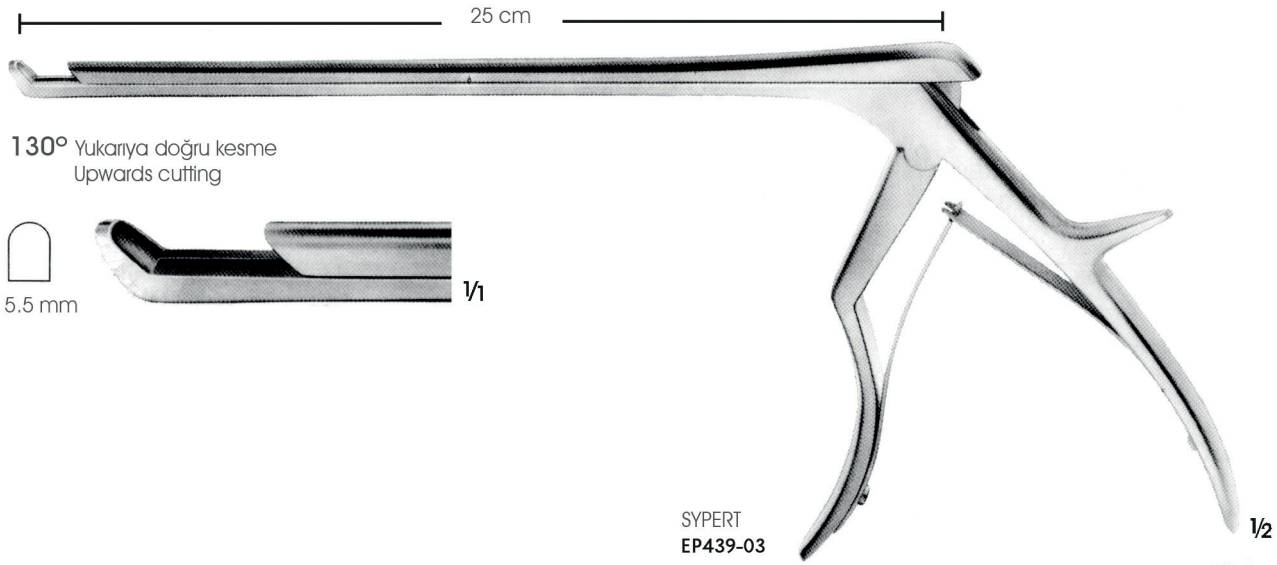

130° Yukarıya doğru kesme/Upwards cutting

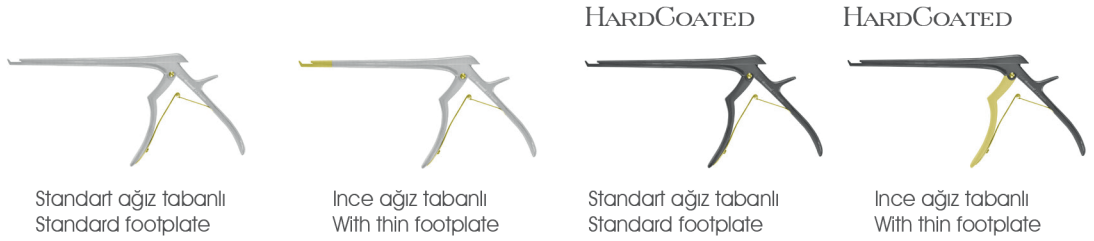

Boy Length	En Width	Ejektör Ejector	Ayrılabilir/Detachable				
18 cm	1 mm	□	-	EP709-01	EP750-01	EP709-01B	EP750-01B
18 cm	2 mm	□	+	EP709-02	EP750-02	EP709-02B	EP750-02B
18 cm	3 mm	□	+	EP709-03	EP750-03	EP709-03B	EP750-03B
18 cm	4 mm	□	+	EP709-04	EP750-04	EP709-04B	EP750-04B
18 cm	5 mm	□	+	EP709-05	EP750-05	EP709-05B	EP750-05B
18 cm	6 mm	□	+	EP709-06		EP709-06B	
20 cm	1 mm	□	-		EP752-01		EP752-01B
20 cm	2 mm	□	+	EP710-02	EP752-02	EP710-02B	EP752-02B
20 cm	3 mm	□	+	EP710-03	EP752-03	EP710-03B	EP752-03B
20 cm	4 mm	□	+	EP710-04	EP752-04	EP710-04B	EP752-04B
20 cm	5 mm	□	+	EP710-05	EP752-05	EP710-05B	EP752-05B
20 cm	6 mm	□	+	EP710-06		EP710-06B	
23 cm	2 mm	□	+	EP172-02	EP754-02	EP712-02B	EP754-02B
23 cm	3 mm	□	+	EP172-03	EP754-03	EP712-03B	EP754-03B
23 cm	4 mm	□	+	EP172-04	EP754-04	EP712-04B	EP754-04B
23 cm	5 mm	□	+	EP172-05	EP754-05	EP712-05B	EP754-05B

90° Yukarıya doğru kesme/Upwards cutting



Standart ağız tabanlı
Standard footplate

HARD COATED



Standart ağız tabanlı
Standard footplate



Standart ağız tabanlı
Standard footplate

Ayrılabilir/Detachable



Standart/Standard



Boy Length	En Widht	Ejektör Ejector			
18 cm	1 mm		-	EP701-01	EP710-01B
18 cm	2 mm		+	EP701-02	EP710-02B
18 cm	3 mm		+	EP701-03	EP710-03B
18 cm	4 mm		+	EP701-04	EP710-04B
18 cm	5 mm		+	EP701-05	EP710-05B
18 cm	6 mm		+	EP701-06	EP710-06B
23 cm	2 mm		+	EP703-02	
23 cm	3 mm		+	EP703-03	
23 cm	4 mm		+	EP703-04	
23 cm	5 mm		+	EP703-05	

90° Aşağıya doğru kesme/Downwards cutting

Ayrılabilir/Detachable



Standart/Standard



Boy Length	En Widht	Ejektör Ejector			
18 cm	1 mm		-	EP705-01	EP433-00
18 cm	2 mm		+	EP705-02	EP433-01
18 cm	3 mm		+	EP705-03	EP433-02
18 cm	4 mm		+	EP705-04	EP433-03
18 cm	5 mm		+	EP705-05	EP433-04
18 cm	6 mm		+	EP705-06	EP433-05
23 cm	2 mm		+	EP702-02	
23 cm	3 mm		+	EP707-03	
23 cm	4 mm		+	EP707-04	
23 cm	5 mm		+	EP707-05	



130° Aşağıya doğru kesme/Downwards cutting



Standart ağız tabanlı
Standard footplate

İnce ağız tabanlı
With thin footplate

Standart ağız tabanlı
Standard footplate

İnce ağız tabanlı
With thin footplate

Ayrılabilir/Detachable

Standart/Standard

Boy
Length

En
Width

Ejektör
Ejector

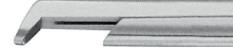
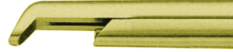
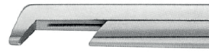

18 cm

1 mm



-

EP714-01

EP757-01

EP432-00

EP435-00

18 cm

2 mm



-

EP714-02

EP757-02

EP432-01

EP435-01

18 cm

3 mm



+

EP714-03

EP757-03

EP432-02

EP435-02

18 cm

4 mm



+

EP714-04

EP757-04

EP432-03

EP435-03

18 cm

5 mm



+

EP714-05

EP757-05

EP432-04

EP435-04

21.5 cm

2 mm



-

EP437-01

21.5 cm

3 mm



-

EP437-02

21.5 cm

4 mm



+

EP437-03

21.5 cm

5 mm



+

EP437-04

23 cm

2 mm



-

EP717-02

EP453-02

23 cm

3 mm



+

EP717-03

EP453-03

23 cm

4 mm



+

EP717-04

EP453-04

23 cm

5 mm



+

EP717-05

EP453-05

130° Yukarıya doğru kesme/Upwards cutting



Standart ağız tabanlı
Standard footplate



İnce ağız tabanlı
With thin footplate

Standart/Standard

Boy Length	En Width			
18 cm	1 mm		EP430-00	EP434-00
18 cm	2 mm		EP430-01	EP434-01
18 cm	3 mm		EP430-02	EP434-02
18 cm	4 mm		EP430-03	EP434-03
18 cm	5 mm		EP430-04	EP434-04
18 cm	6 mm		EP430-05	
20 cm	1 mm			EP441-01
20 cm	2 mm		EP438-01	EP441-02
20 cm	3 mm		EP438-02	EP441-03
20 cm	4 mm		EP438-03	EP441-04
20 cm	5 mm		EP438-04	EP441-05
20 cm	6 mm		EP438-05	
21.5 cm	2 mm		EP436-01	
21.5 cm	3 mm		EP436-02	
21.5 cm	4 mm		EP436-03	
21.5 cm	5 mm		EP436-04	
23 cm	2 mm		EP452-02	EP449-02
23 cm	3 mm		EP452-03	EP449-03
23 cm	4 mm		EP452-04	EP449-04
23 cm	5 mm		EP452-05	EP449-05



