

EN

Kemik Küretkeri  
Bone Curettes

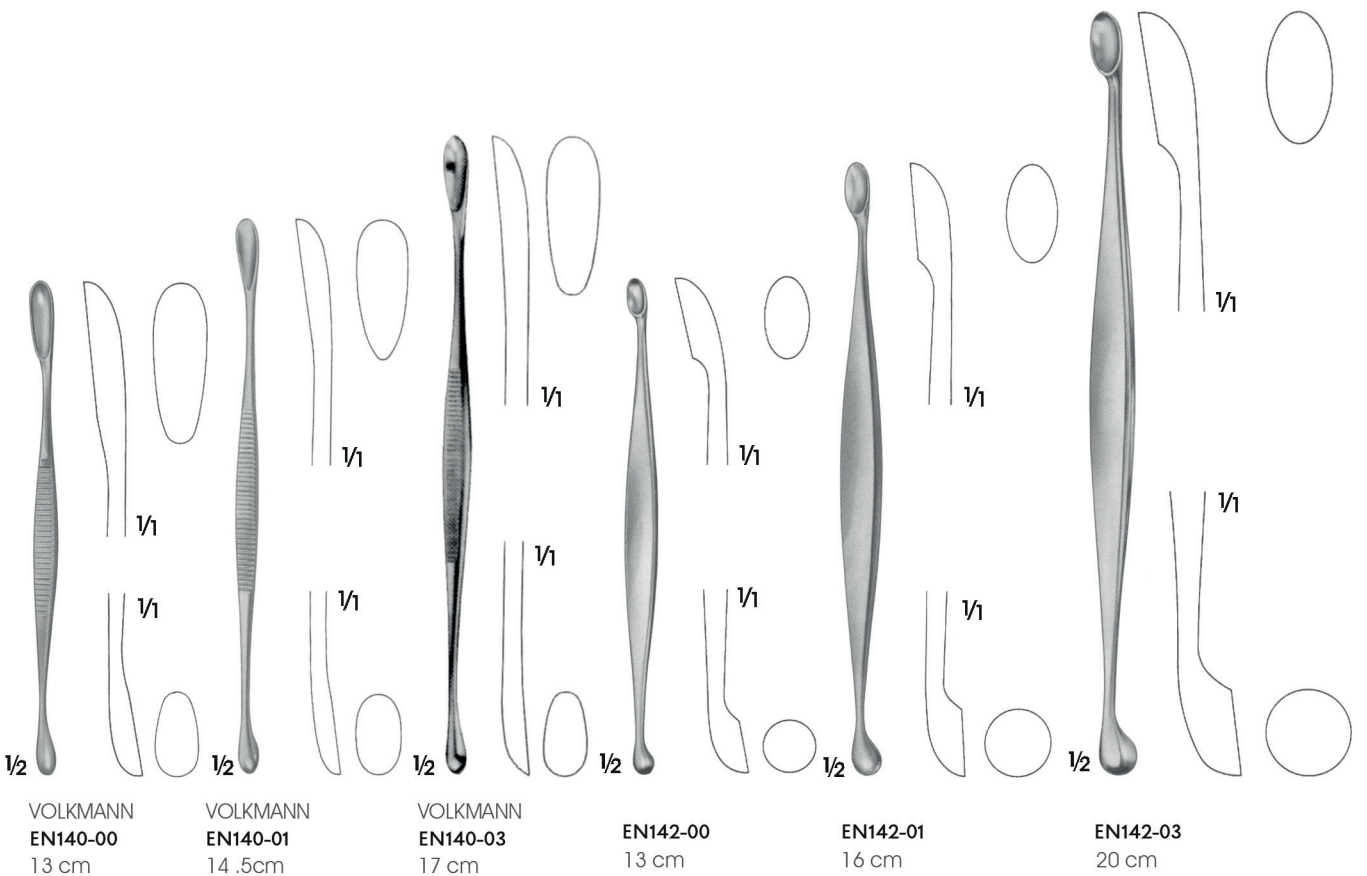

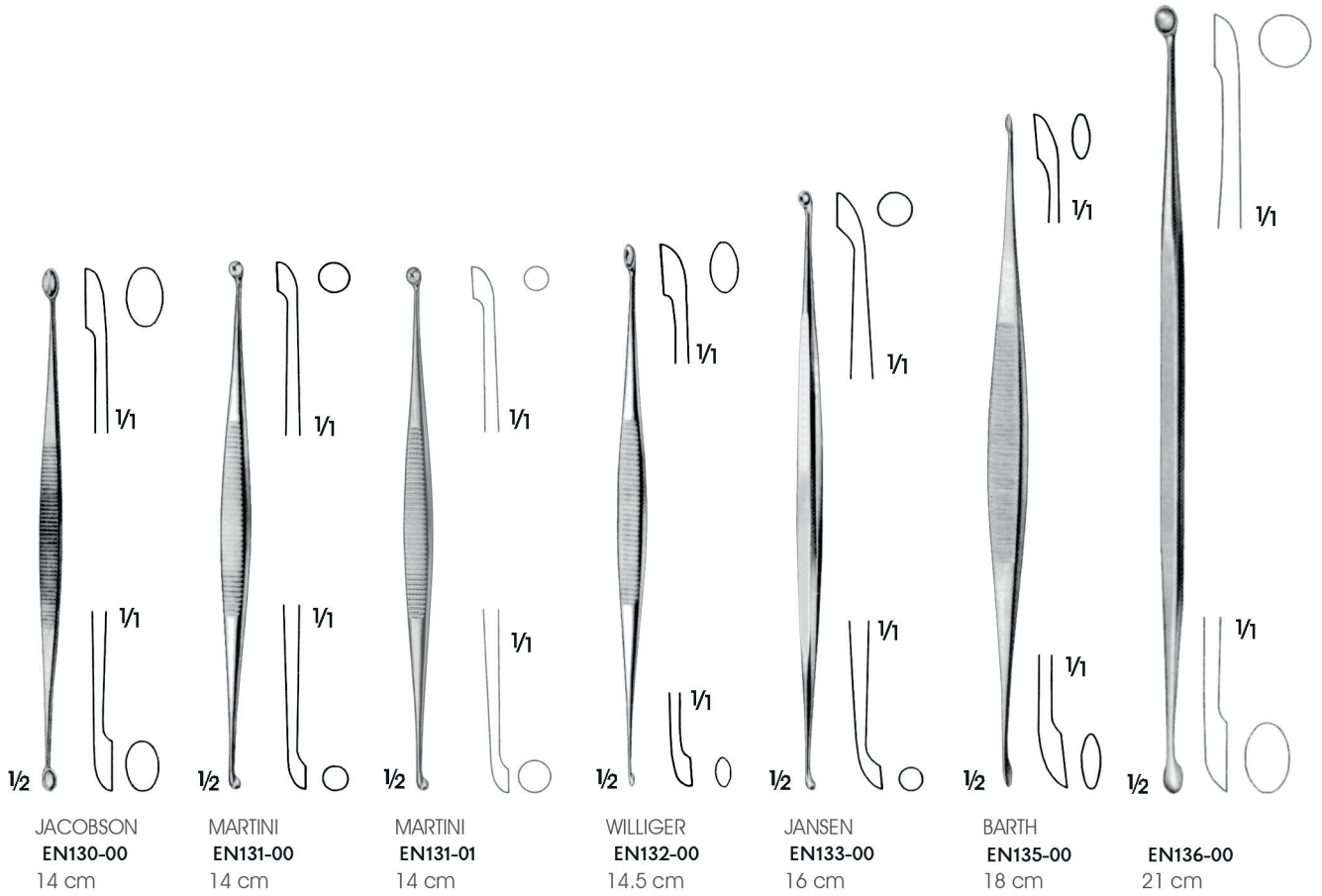

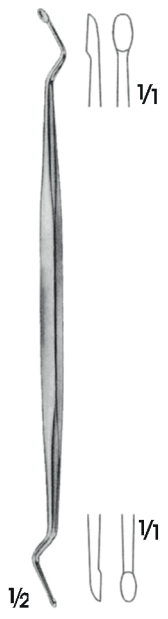

EN150-00  
16 cm



JANSEN  
EN151-00  
16 cm

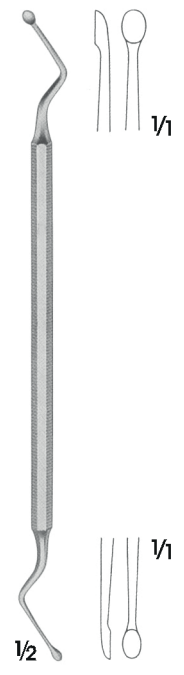

HEMINGWAY  
EN152-00  
17 cm

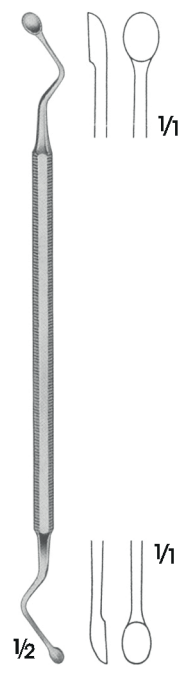

HEMINGWAY  
EN152-01  
17 cm

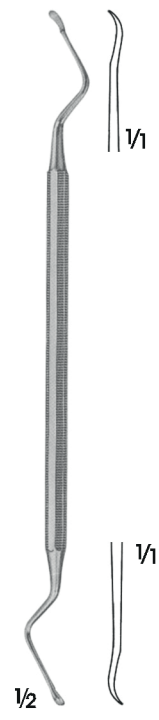

LUCAS  
EN155-00  
18 cm

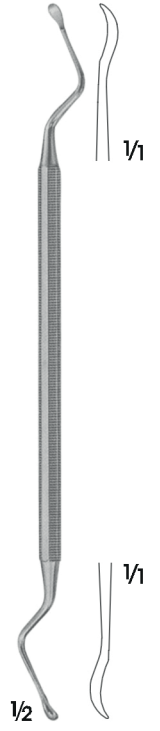

LUCAS  
EN155-01  
18.5 cm

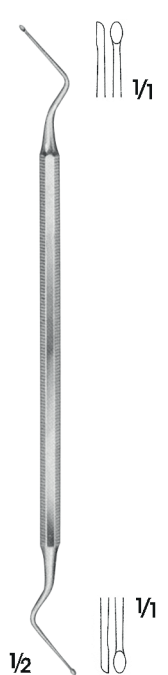

HEMINGWAY  
EN153-00  
fig. 0  
17 cm

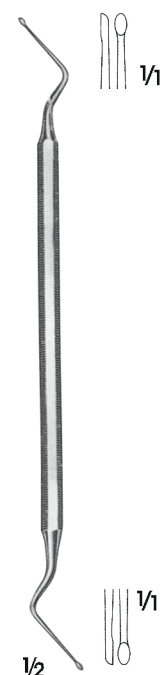

HEMINGWAY  
EN153-01  
fig. 1  
17 cm

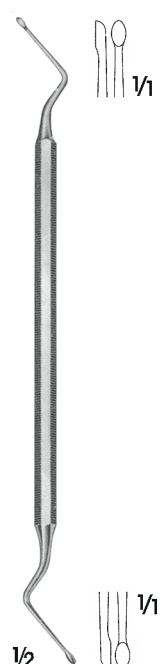

HEMINGWAY  
EN153-02  
fig. 2  
17 cm

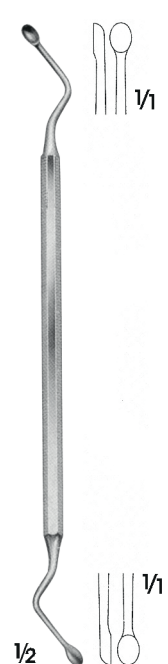

HEMINGWAY  
EN153-03  
fig. 3  
17 cm

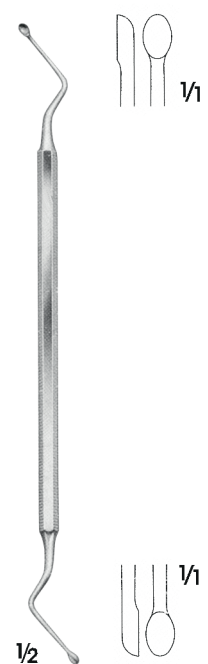

HEMINGWAY  
EN153-04  
fig. 4  
17 cm



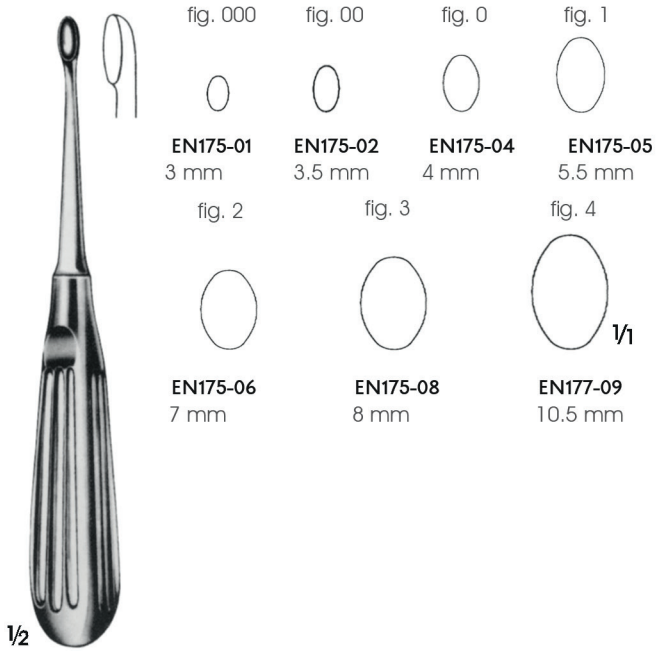

SCHEDÉ  
EN175-01-EN175-09  
17 cm

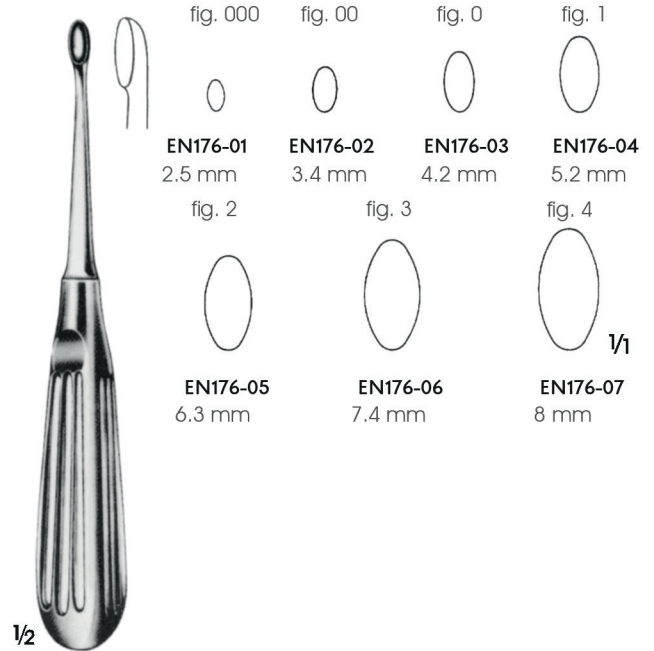

SCHEDÉ  
EN176-01-EN176-07  
17 cm

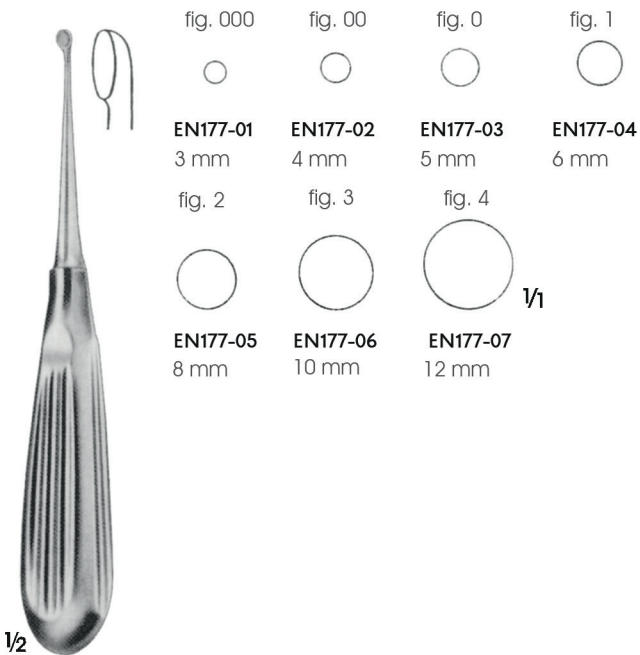

BRUNS  
EN177-01-EN177-07  
16.5 cm

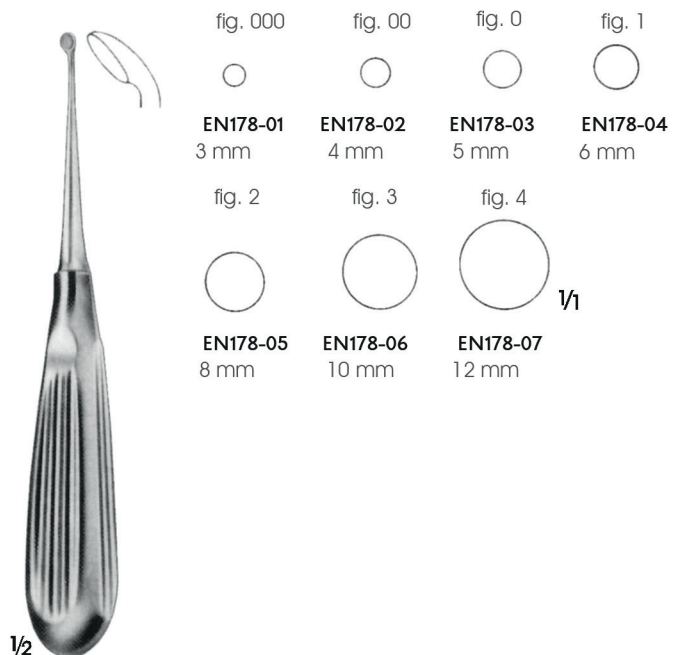

BRUNS  
EN178-01-EN178-07  
16.5 cm





1/2

VOLKMAN  
EN179-01-EN179-10  
17 cm

fig. 0000  EN179-01 2.8 mm	fig. 000  EN179-02 3.6 mm	fig. 00  EN179-03 4.4 mm	fig. 0  EN179-04 5.2 mm	fig. 1  EN179-05 6.8 mm
fig. 2  EN179-06 8.5 mm	fig. 3  EN179-07 10 mm	fig. 4  EN179-08 11.5 mm	fig. 5  EN179-09 13 mm	fig. 6  EN179-10 14.5 mm



1/2

WILLIGER  
EN180-01-EN180-02  
17 cm

fig. 00  EN180-01 3.4 mm	fig. 1  EN180-02 5.2 mm
-----------------------------------	----------------------------------

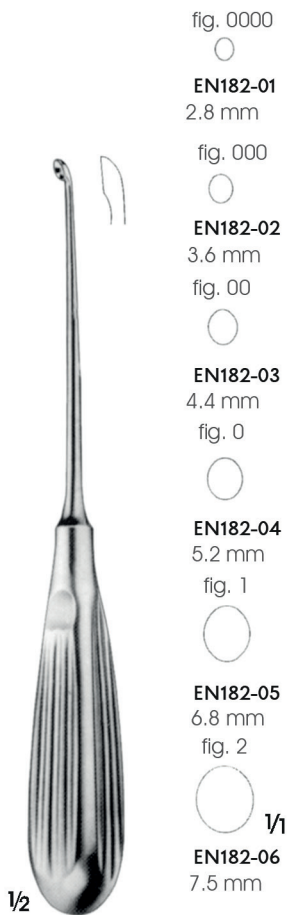

1/2

EN182-01-EN182-06  
20 cm

fig. 0000  EN182-01 2.8 mm	fig. 000  EN182-02 3.6 mm	fig. 00  EN182-03 4.4 mm	fig. 0  EN182-04 5.2 mm	fig. 1  EN182-05 6.8 mm	fig. 2  EN182-06 7.5 mm
-------------------------------------	------------------------------------	-----------------------------------	----------------------------------	----------------------------------	----------------------------------



1/2

EN183-01-EN183-06  
20 cm

fig. 0000  EN183-01 2.8 mm	fig. 000  EN183-02 3.6 mm	fig. 00  EN183-03 4.4 mm	fig. 0  EN183-04 5.2 mm	fig. 1  EN183-05 6.8 mm	fig. 2  EN183-06 7.5 mm
-------------------------------------	------------------------------------	-----------------------------------	----------------------------------	----------------------------------	----------------------------------



1/2

EN184-01-EN184-06  
20 cm

fig. 0000  EN184-01 2.8 mm	fig. 000  EN184-02 3.6 mm	fig. 00  EN184-03 4.4 mm	fig. 0  EN184-04 5.2 mm	fig. 1  EN184-05 6.8 mm	fig. 2  EN184-06 7.5 mm
-------------------------------------	------------------------------------	-----------------------------------	----------------------------------	----------------------------------	----------------------------------





fig. 0000  
○  
**EN185-01**  
2.8 mm

fig. 000  
○  
**EN185-02**  
3.6 mm

fig. 00  
○  
**EN185-03**  
4.4 mm

fig. 0  
○ 1/1  
**EN185-04**  
5.2 mm

**DAUBENSPECK**  
**EN185-01-EN185-04**  
20 cm

1/2



fig. 0000  
○  
**EN186-01**  
1.8 mm

fig. 000  
○  
**EN186-02**  
2.0 mm

fig. 00  
○  
**EN186-03**  
2.4 mm

fig. 0  
○  
**EN186-04**  
2.6 mm

fig. 1  
○ 1/1  
**EN186-05**  
2.8 mm

**LEMBERT**  
**EN186-01-EN186-05**  
21.5 cm

1/2



fig. 00  
○  
**EN187-01**  
4.4 mm

fig. 0  
○  
**EN187-02**  
5.2 mm

fig. 1  
○ 1/1  
**EN187-03**  
6.8 mm

**HALLE**  
**EN187-01-EN187-03**  
Esnek/Malleable  
21.5 cm

1/2



fig. 000  
○  
**EN190-01**  
3.6 mm

fig. 00  
○  
**EN190-02**  
4.4 mm

fig. 0  
○  
**EN190-03**  
5.2 mm

fig. 1  
○ 1/1  
**EN190-04**  
6.8 mm

**EN190-01-EN190-04**  
25 cm

1/2



fig. 000  
○  
**EN192-01**  
3.6 mm

fig. 00  
○  
**EN192-02**  
4.4 mm

fig. 0  
○  
**EN192-03**  
5.2 mm

fig. 1  
○ 1/1  
**EN192-04**  
6.8 mm

**EN192-01-EN192-04**  
25 cm

1/2



fig. 000  
○  
**EN193-01**  
3 mm

fig. 00  
○  
**EN193-02**  
4 mm

fig. 1  
○ 1/1  
**EN193-03**  
5 mm

**BUSHE**  
**EN193-01-EN193-03**  
25 cm

1/2

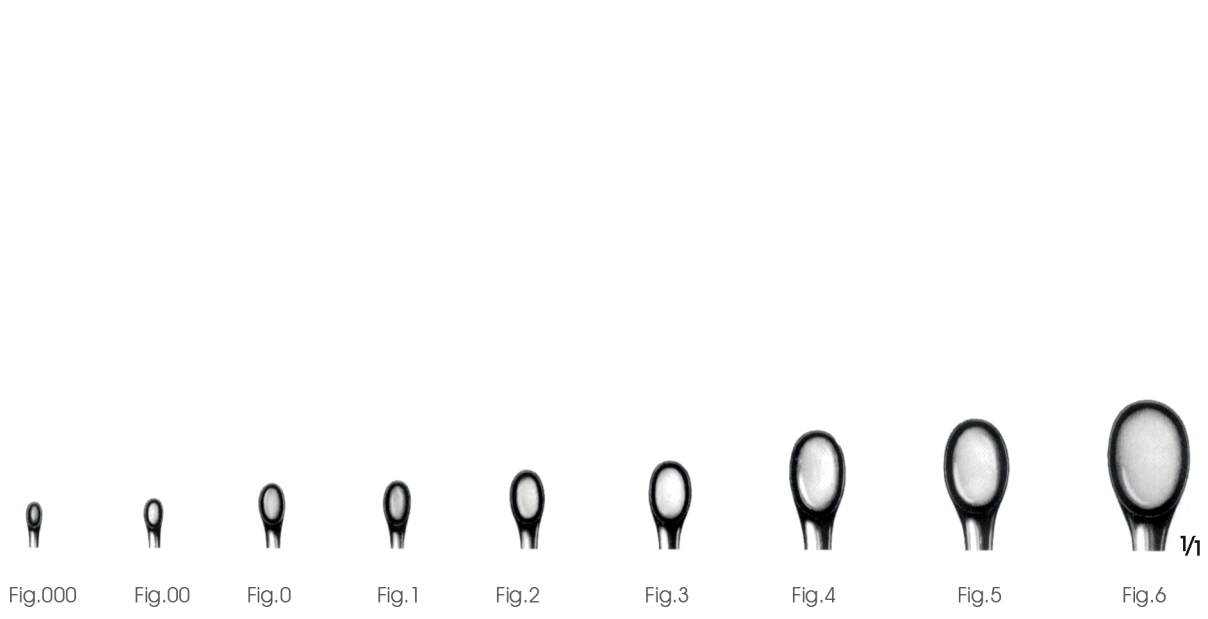

EN200-01 1.8 mm	EN200-02 2.2 mm	EN200-03 3.5 mm	EN200-04 4.0 mm	EN200-05 4.5 mm	EN200-06 5.5 mm	EN200-07 7.2 mm	EN200-08 8.5 mm	EN200-09 10.5 mm
EN202-01 1.8 mm	EN202-02 2.2 mm	EN202-03 3.5 mm	EN202-04 4.0 mm	EN202-05 4.5 mm	EN202-06 5.5 mm	EN202-07 7.2 mm	EN202-08 8.5 mm	EN202-09 10.5 mm
EN203-01 1.8 mm	EN203-02 2.2 mm	EN203-03 3.5 mm	EN203-04 4.0 mm	EN203-05 4.5 mm	EN203-06 5.5 mm	EN203-07 7.2 mm	EN203-08 8.5 mm	EN203-09 10.5 mm

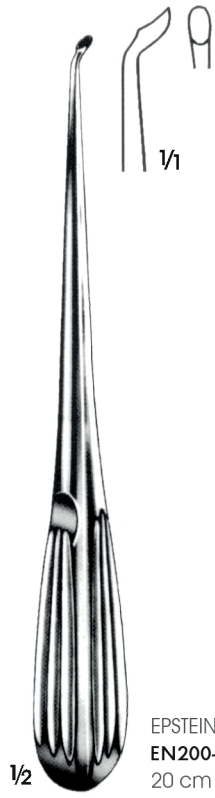

EPSTEIN  
EN200-01-EN200-09  
20 cm

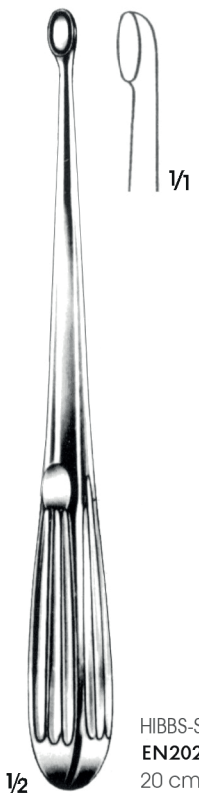

HIBBS-SPRATT  
EN202-01-EN202-09  
20 cm



HIBBS-SPRATT  
EN203-01-EN203-09  
20 cm

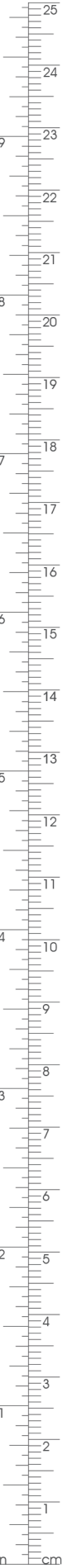



EN205-01 1.8 mm	EN205-02 2.2 mm	EN205-03 3.5 mm	EN205-04 4.0 mm	EN205-05 4.5 mm	EN205-06 5.5 mm	EN205-07 7.2 mm	EN205-08 8.5 mm	EN205-09 10.5 mm
EN206-01 1.8 mm	EN206-02 2.2 mm	EN206-03 3.5 mm	EN206-04 4.0 mm	EN206-05 4.5 mm	EN206-06 5.5 mm	EN206-07 7.2 mm	EN206-08 8.5 mm	EN206-09 10.5 mm
EN210-01 1.8 mm	EN210-02 2.2 mm	EN210-03 3.5 mm	EN210-04 4.0 mm	EN210-05 4.5 mm	EN210-06 5.5 mm	EN210-07 7.2 mm	EN210-08 8.5 mm	EN210-09 10.5 mm
EN211-01 1.8 mm	EN211-02 2.2 mm	EN211-03 3.5 mm	EN211-04 4.0 mm	EN211-05 4.5 mm	EN211-06 5.5 mm	EN211-07 7.2 mm	EN211-08 8.5 mm	EN211-09 10.5 mm



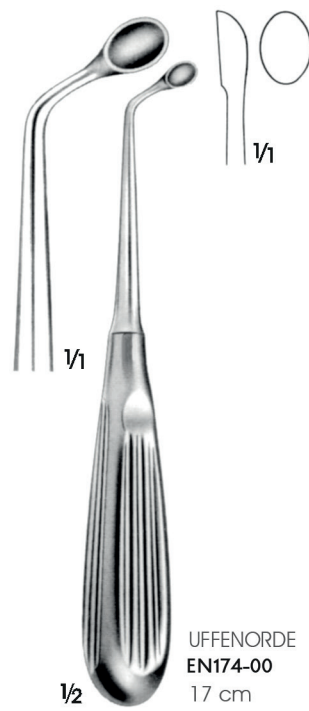
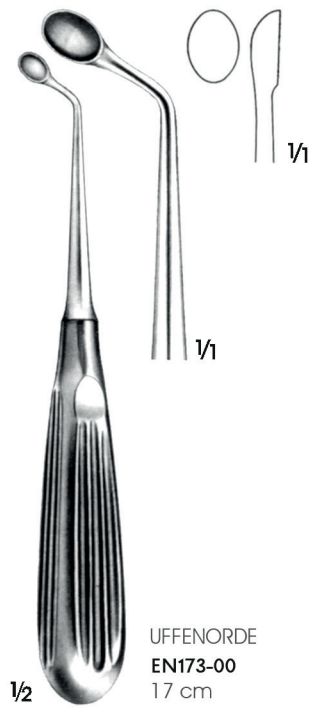
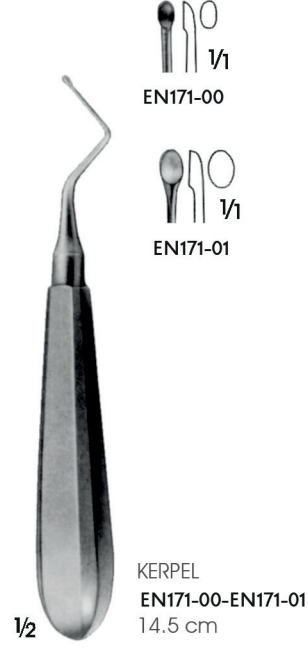
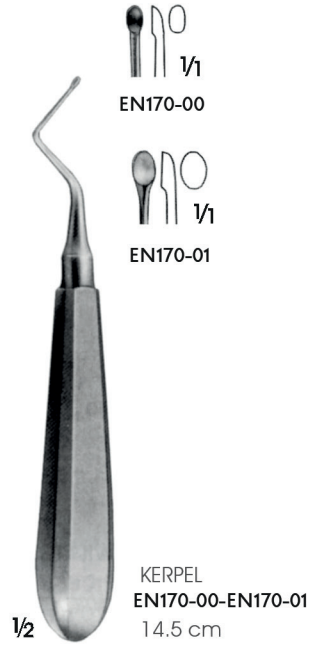





EN420-00-EN421-14  
21.5 cm

Öne/Forward  
Düz/Straight



0000	000	00	0	1
0	0	0	0	0
EN420-00	EN420-01	EN420-02	EN420-03	EN420-04

Öne/Forward  
Açılı/Angle



0000	000	00	0	1
0	0	0	0	0
EN421-00	EN421-01	EN421-02	EN421-03	EN421-04

Geriyeye/Backward  
Düz/Straight



0000	000	00	0	1
0	0	0	0	0
EN420-10	EN420-11	EN420-12	EN420-13	EN420-14

Geriyeye/Backward  
Açılı/Angle



0000	000	00	0	1
0	0	0	0	0 1/1
EN421-10	EN421-11	EN421-12	EN421-13	EN421-14



EN423-00-EN424-14  
24 cm

Öne/Forward  
Düz/Straight



0000	000	00	0	1
0	0	0	0	0
EN423-00	EN423-01	EN423-02	EN423-03	EN423-04

Öne/Forward  
Açılı/Angle



0000	000	00	0	1
0	0	0	0	0
EN424-00	EN424-01	EN424-02	EN424-03	EN424-04

Geriyeye/Backward  
Düz/Straight



0000	000	00	0	1
0	0	0	0	0
EN423-10	EN423-11	EN423-12	EN423-13	EN423-14

Geriyeye/Backward  
Açılı/Angle



0000	000	00	0	1
0	0	0	0	0 1/1
EN424-10	EN424-11	EN424-12	EN424-13	EN424-14



EN430-00-EN432-02  
24 cm

Geriyeye/Backward  
Düz/Straight



0



EN430-00

1



EN430-01

2



EN430-02

Geriyeye/Backward  
Açılı/Angle



0



EN431-00

1



EN431-01

2



EN431-02

Geriyeye/Backward  
Aşağı/Down



0



EN432-00

1



EN432-01

2



EN432-02 1/1



EN430-10-EN432-12  
24 cm

Öne/Forward  
Düz/Straight



0



EN430-10

1



EN430-11

2



EN430-12

Öne/Forward  
Açılı/Angle



0



EN431-10

1



EN431-11

2



EN431-12

Öne/Forward  
Aşağı/Down



0



EN432-10

1



EN432-11

2



EN432-12 1/1



143° buhar sterilizatörlerinde steril edilebilir.  
Can be sterilized in a steam sterilizer up to 143°

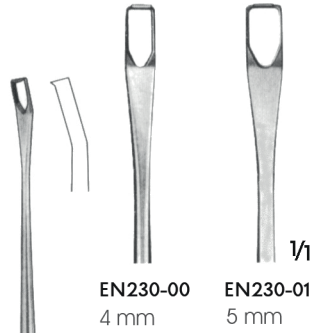
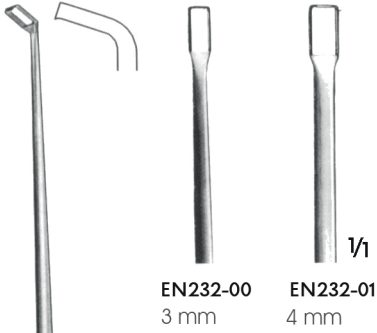

$\frac{1}{2}$   
CASPAR  
EN232-00-EN230-01  
Dişli/Toothed  
27 cm



$\frac{1}{2}$   
CASPAR  
EN230-00-EN230-01  
Dişli/Toothed  
25 cm



$\frac{1}{2}$   
CASPAR  
EN270-01P-EN270-03P  
22 cm

143° buhar sterilizatörlerinde steril edilebilir.  
Can be sterilized in a steam sterilizer up to 143°

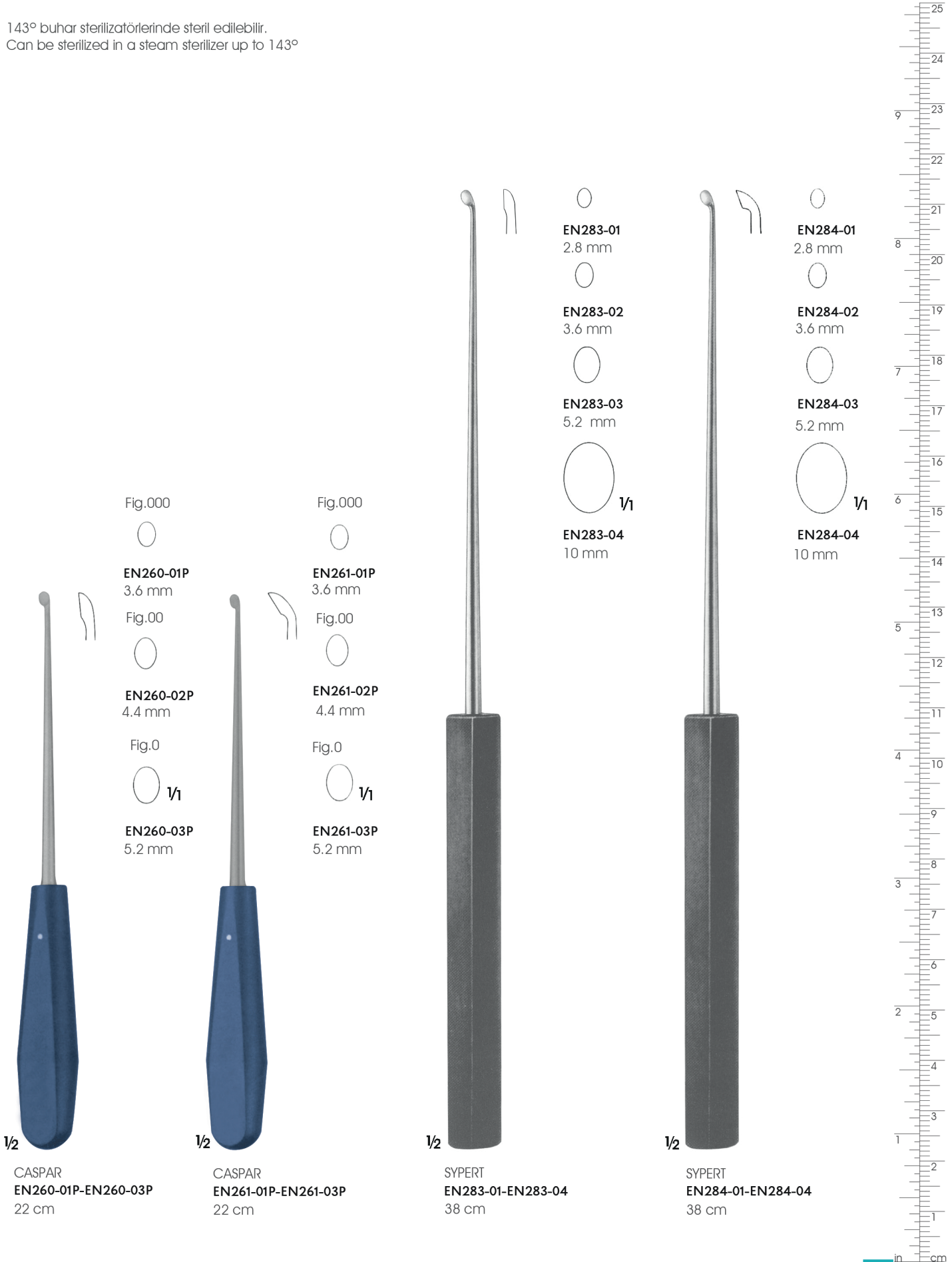
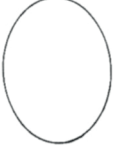

fig. 6



**EN500-11**  
14.5 mm

fig. 5



**EN500-10**  
13 mm

fig. 4

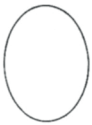

**EN500-09**  
11.5 mm

fig. 3



**EN500-08**  
10 mm

fig. 2



**EN500-06**  
8.5 mm

fig. 1



**EN500-06**  
6.8 mm



**1/2**

**SIMON**  
**EN500-06-EN500-11**  
24 cm

fig. 6



**EN502-11**  
14.5 mm

fig. 5

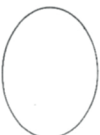

**EN502-10**  
13 mm

fig. 4



**EN502-19**  
11.5 mm

fig. 3



**EN502-08**  
10 mm

fig. 2



**EN502-07**  
8.5 mm

fig. 1



**EN502-06**  
6.8 mm



**1/2**

**SCHRÖDER**  
**EN502-06-EN502-11**  
31 cm

fig. 6



**EN510-14**  
14 mm

fig. 5



**EN510-12**  
12 mm

fig. 4



**EN510-10**  
10 mm

fig. 3



**EN510-08**  
8 mm

fig. 2



**EN510-06**  
6 mm



**1/2**

**GOURDET**  
**EN510-06-EN510-14**  
Künt/Blunt  
28 cm



143° buhar sterilizörlerinde steril edilebilir.  
Can be sterilized in a steam sterilizer up to 143°

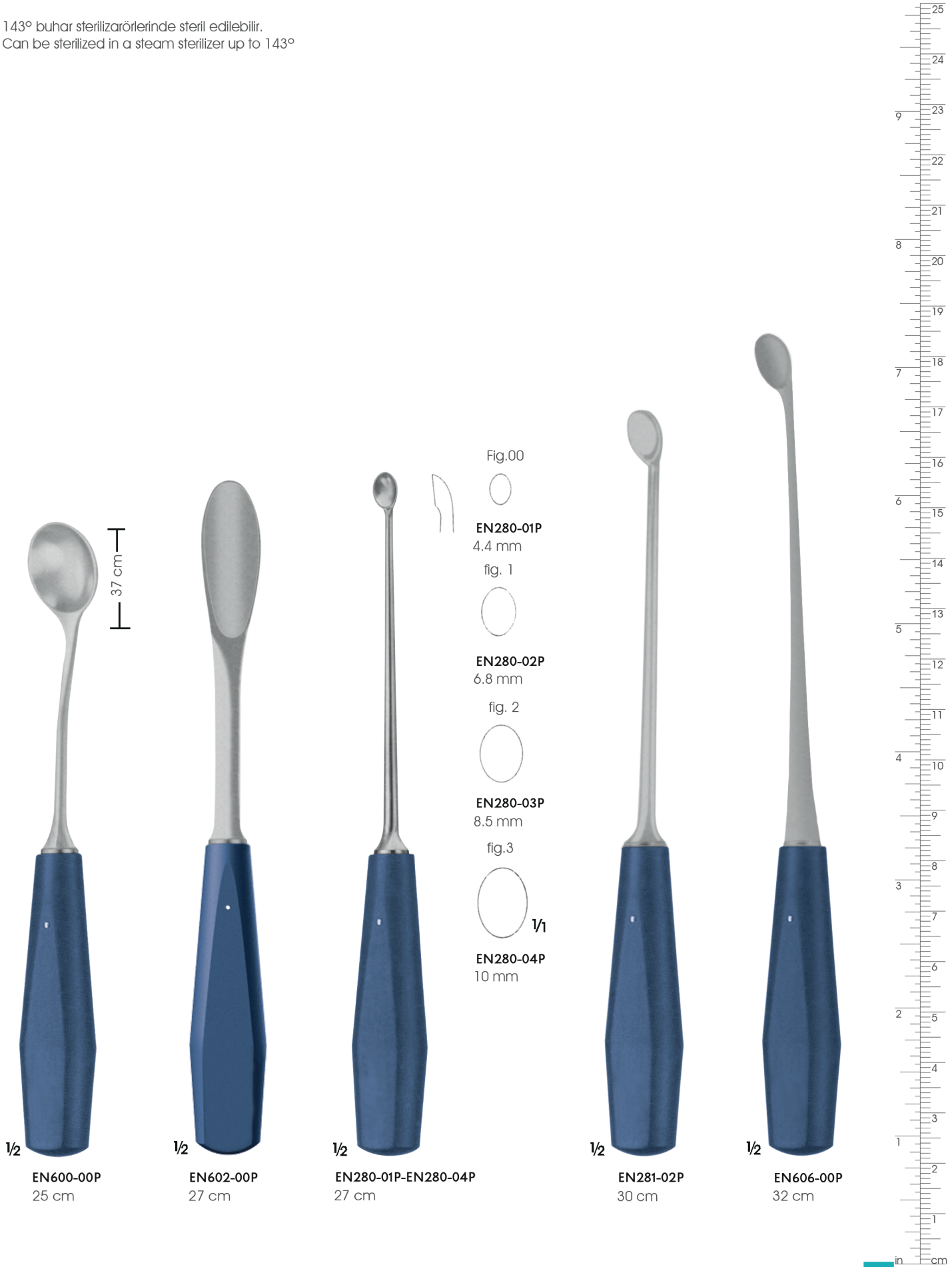

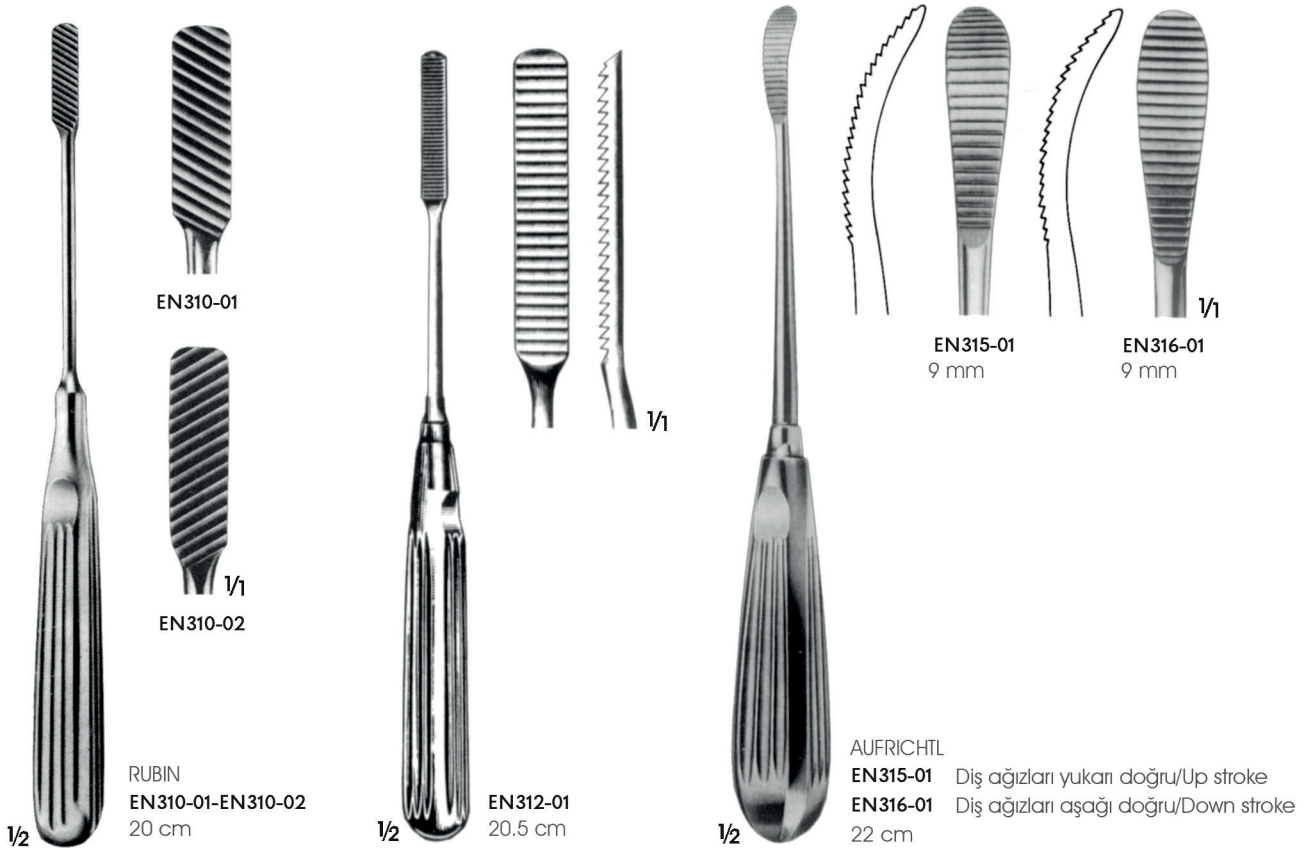
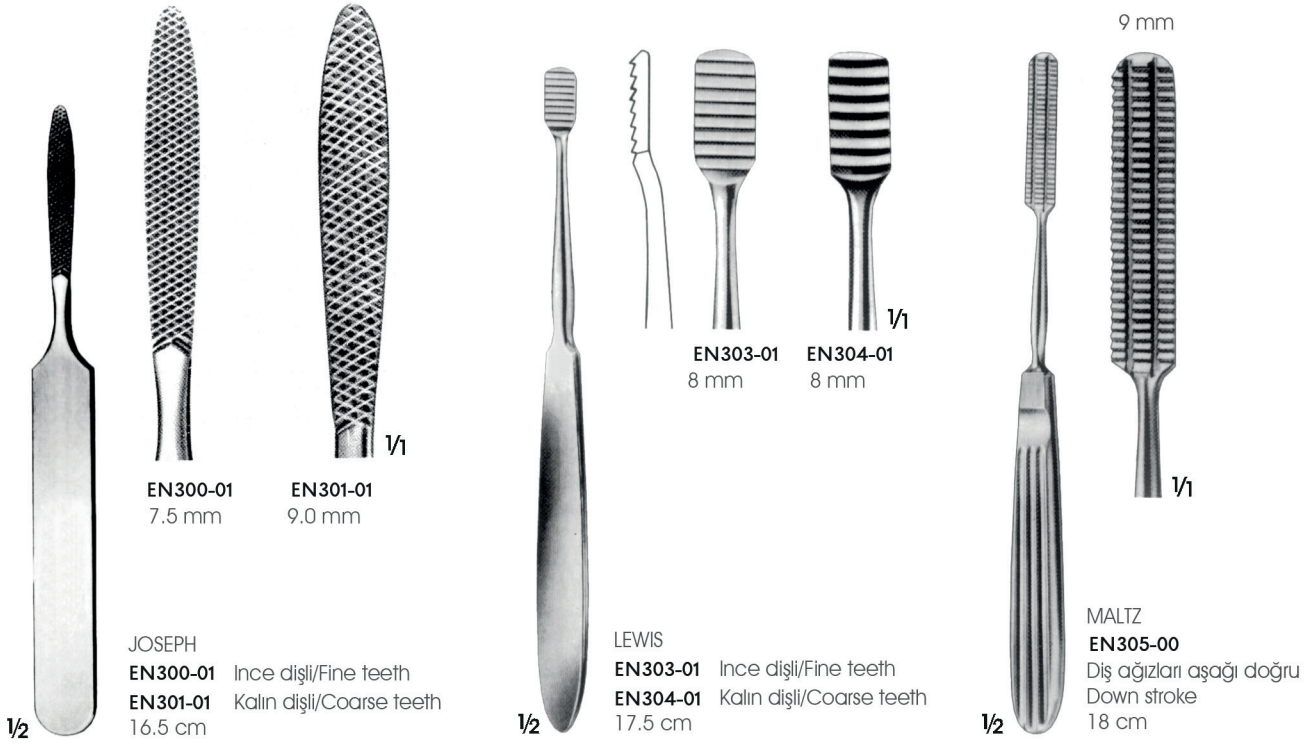

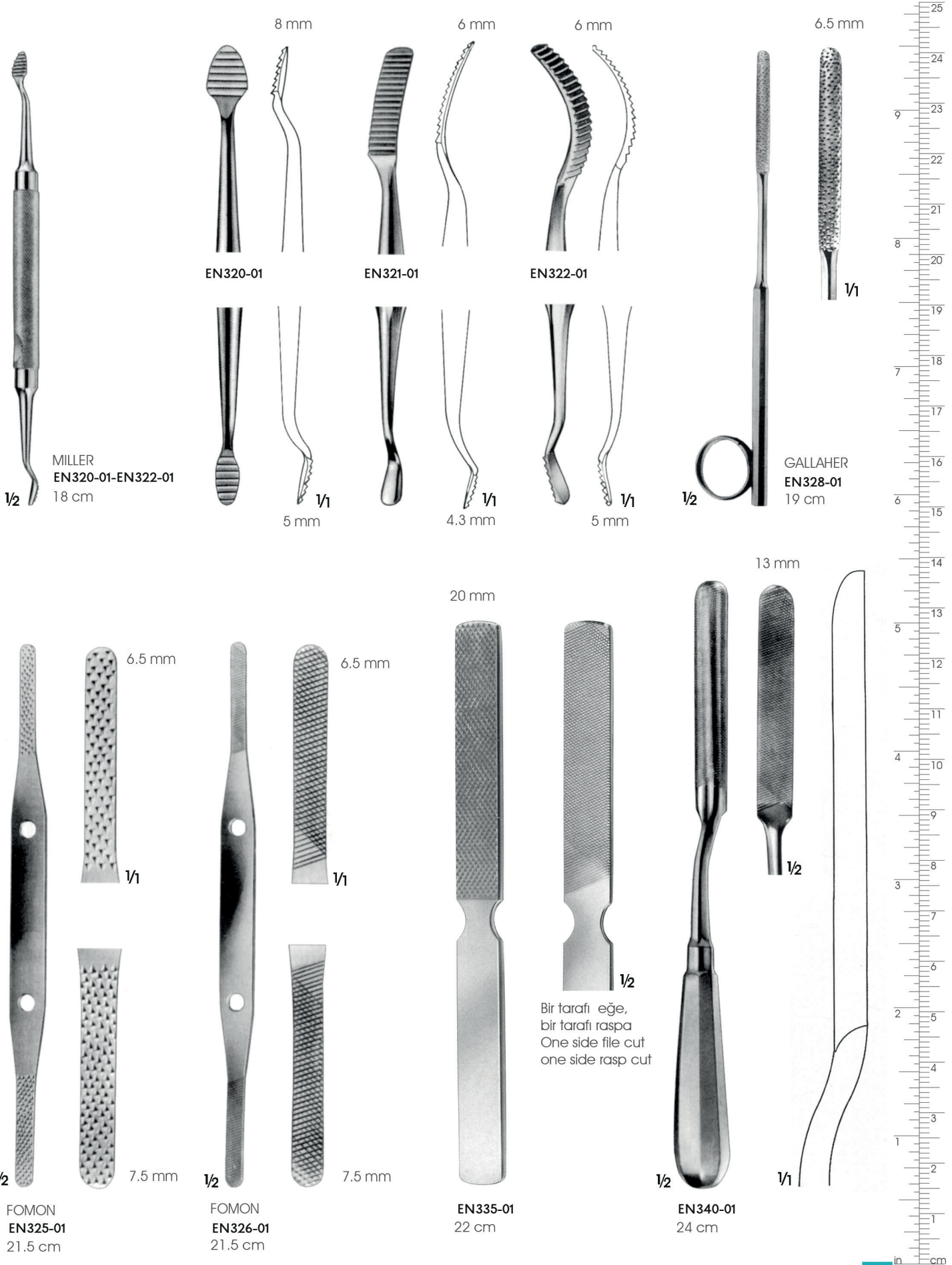

7 mm



7 mm

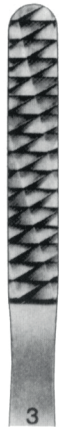

7 mm

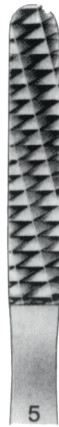

7 mm

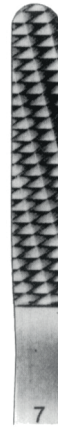

7 mm



Dış  
Teeth

EN322-01  
12/14

EN322-02  
16/20

EN322-03  
24/30

EN322-04  
36/44

EN322-05  
52/62

1/1

1/2

EN322-01-EN322-05  
20.5 cm



18 mm

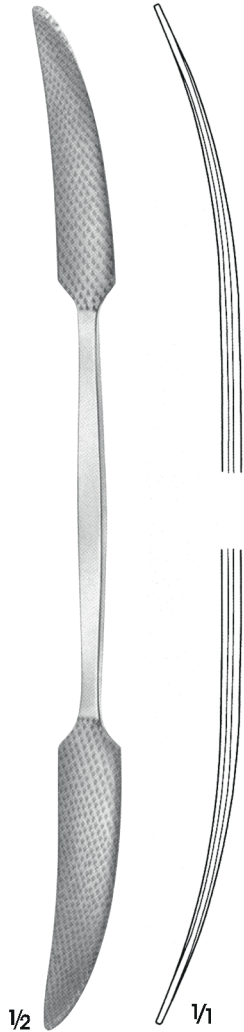

1/2  
20 mm  
PUTTI  
EN345-01  
27 cm

20 mm

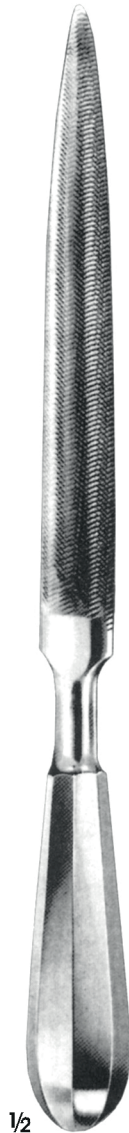

1/2  
EN348-01  
29.5 cm



1/2  
PUTTI  
EN347-01  
30 cm





