

EM

Raspalar, Disektörler ve Elevatörler
Raspatories, Dissectors and Levers

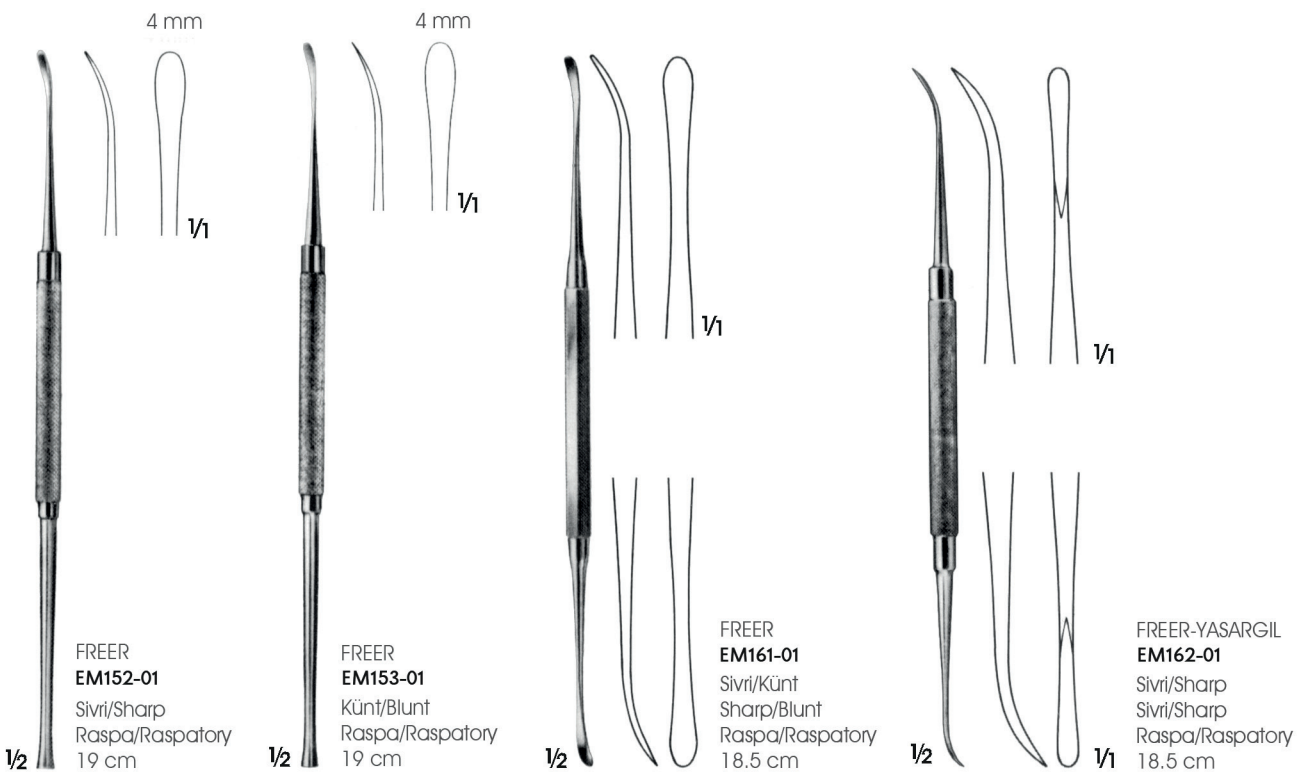

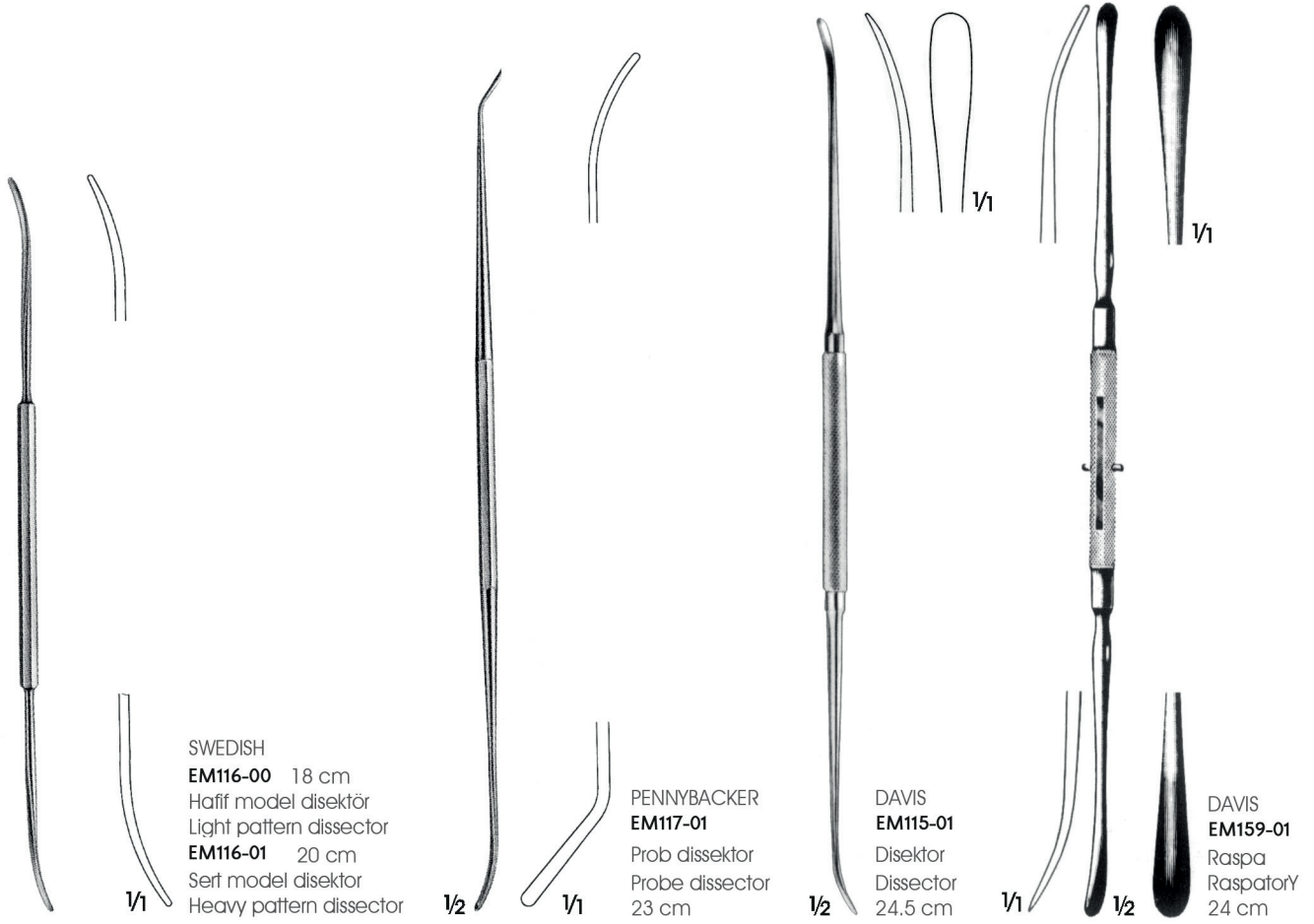

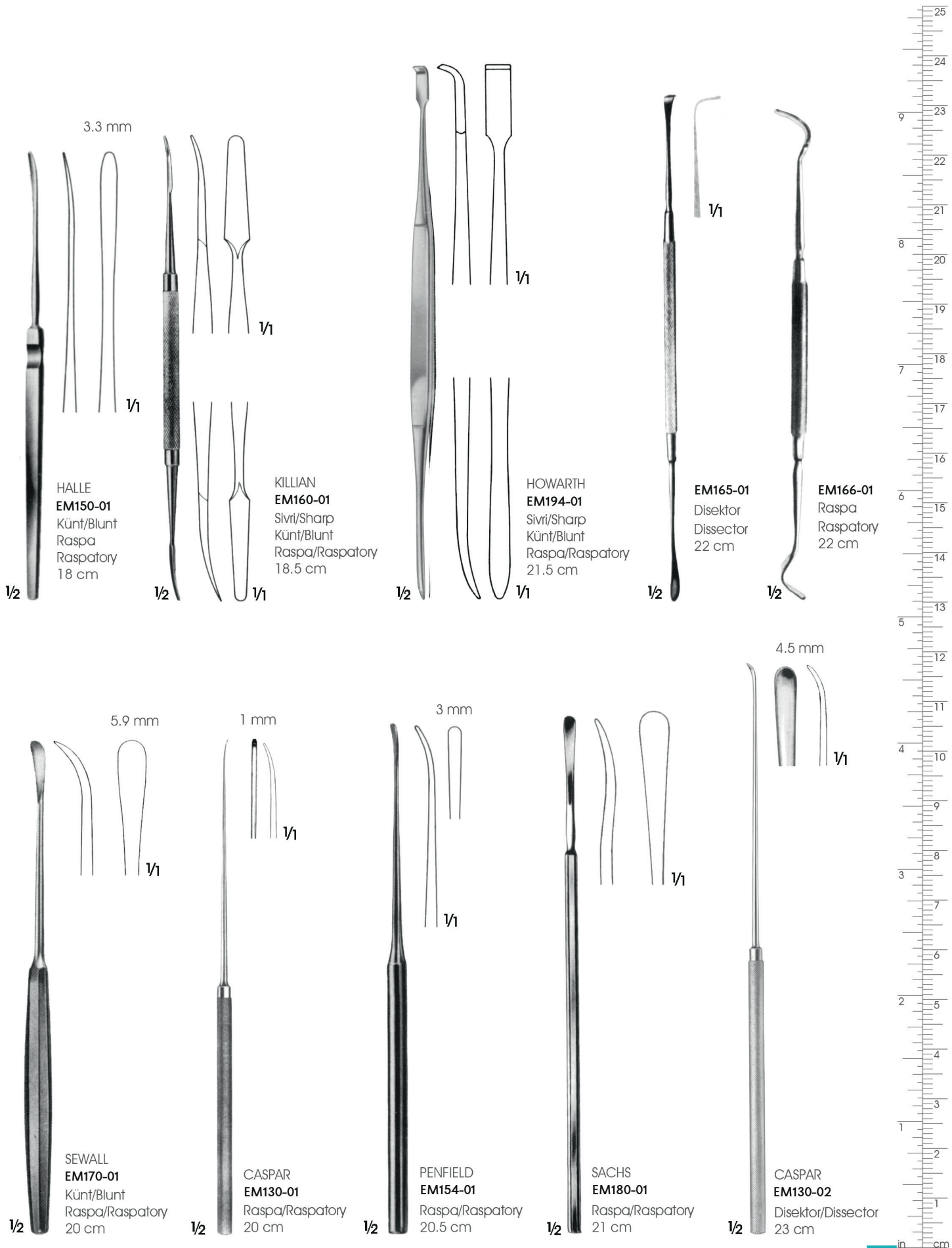

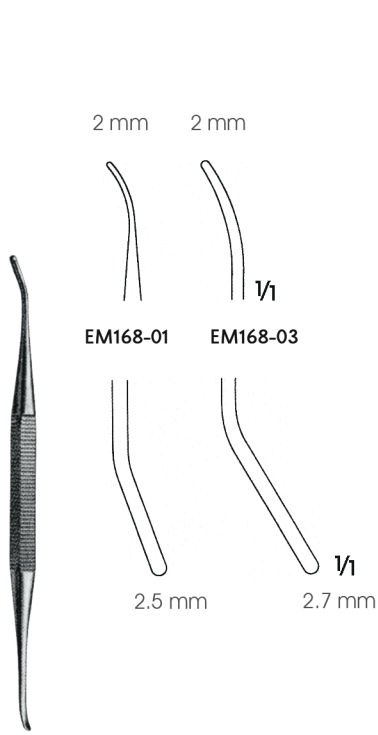

WATSON-CHEYNE
EM168-01 13 cm
EM168-03 19 cm
Raspalar/Raspatory

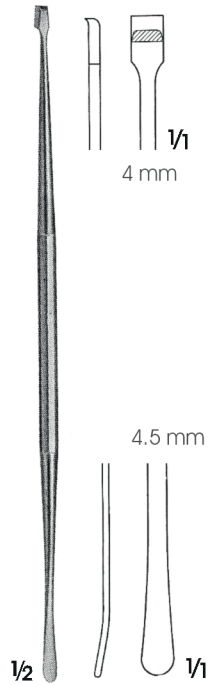

FREER
EM167-00
Raspa/Raspatory
18 cm

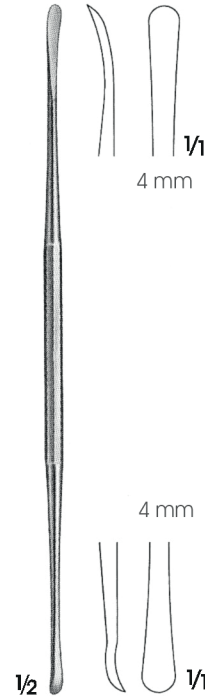

SYME
EM169-00 Sivri/Sharp
Raspa/Raspatory
18.5 cm

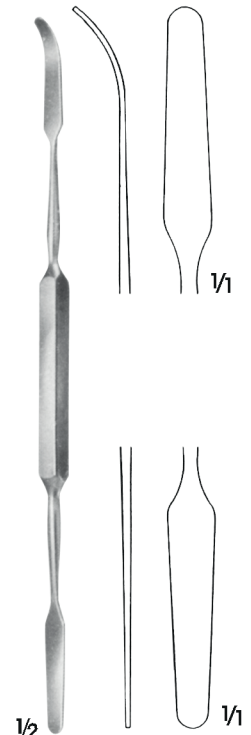

MAC DONALD
EM190-01
Künt/Blunt
Künt/Blunt
Dissektor/ Dissector
18.5 cm

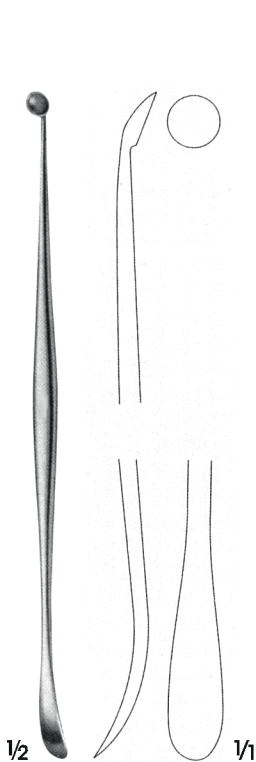

PENFIELD
EM178-00
Dissektor/Dissector
Çif uçlu/Double-Ended
17.5 cm

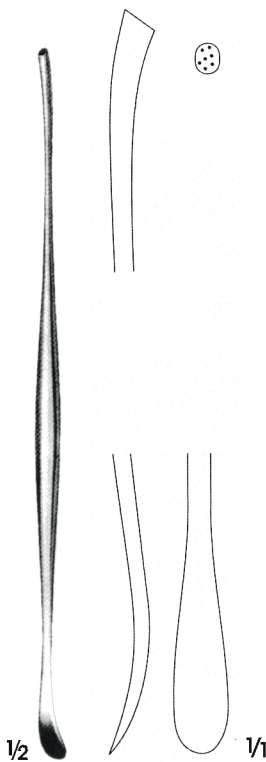

PENFIELD
EM175-01 Fig.2
Dissektor/Dissector
Çif uçlu/Double-Ended
19.5 cm

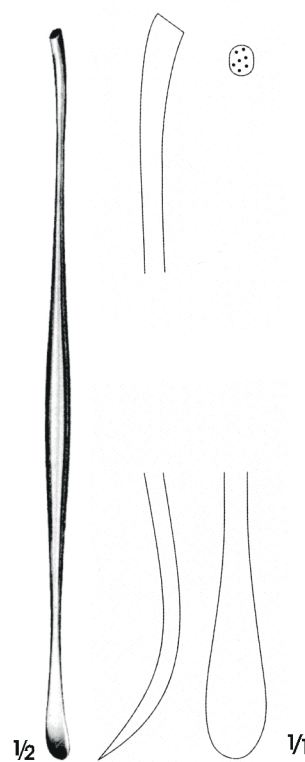

PENFIELD
EM175-02 Fig.3
Dissektor/Dissector
Çif uçlu/Double-Ended
19.5 cm



CARTER
EM179-01
Raspa/Raspatory
21 cm



FRAZIER
EM182-00
Raspa/Raspatory
15 cm



HOEN
EM182-01
Raspa/Raspatory
15 cm

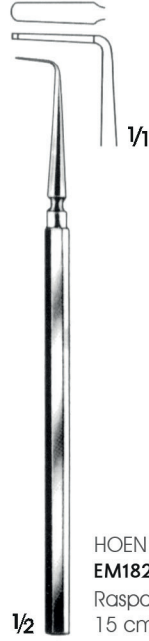

HOEN
EM182-02
Raspa/Raspatory
15 cm



FREER
EM177-01
Raspa/Raspatory
20 cm

Sivri/Sharp

Künt/Blunt

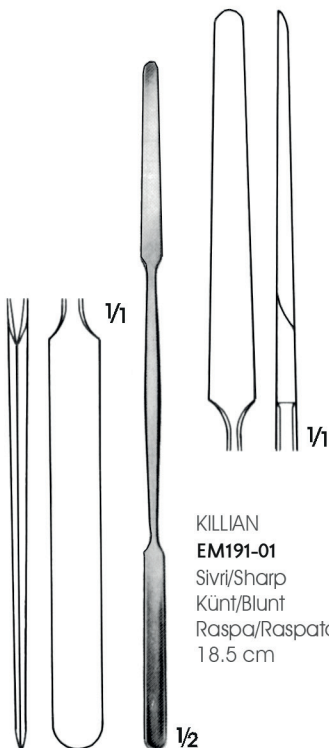

KILLIAN
EM191-01
Sivri/Sharp
Künt/Blunt
Raspa/Raspatory
18.5 cm

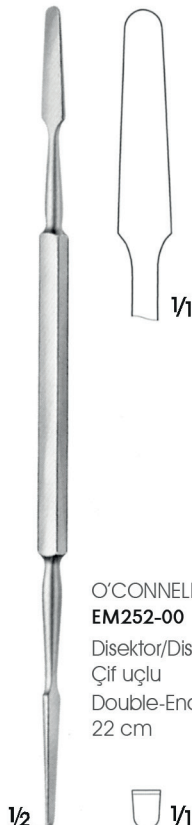

O'CONNELL
EM252-00
Disektor/Dissector
Çif uçlu
Double-Ended
22 cm



MILLIGAN
EM188-01
Raspa/Raspatory
21 cm

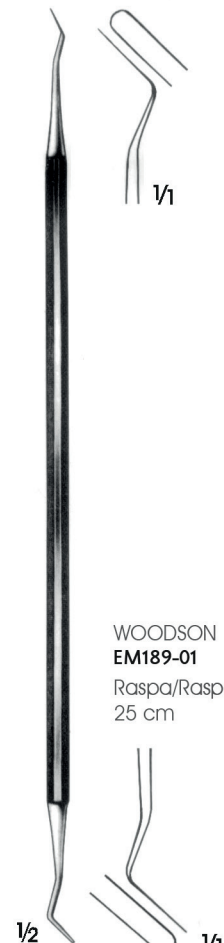

WOODSON
EM189-01
Raspa/Raspatory
25 cm



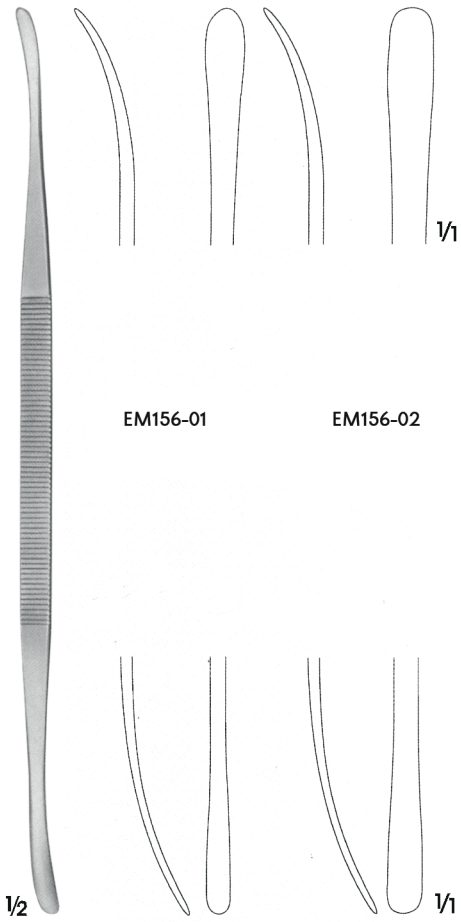

EM156-01

EM156-02

TÖNNIS
EM156-01-EM156-02
Disektörler/Dissectors
24 cm



HILL
EM199-00
Raspa/Raspatory
Yarı sivri/Künt
Semi-sharp/Blunt
22 cm

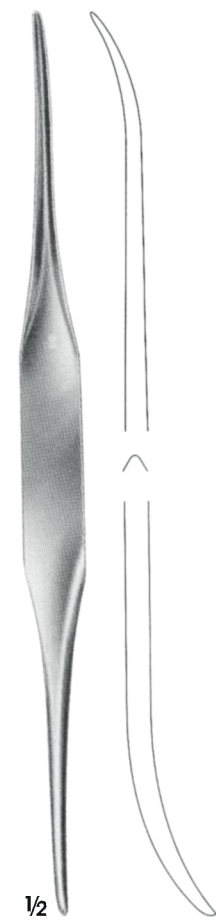

TÖNNIS
EM202-00
Çift taraflı yönlendirici
Director
24 cm

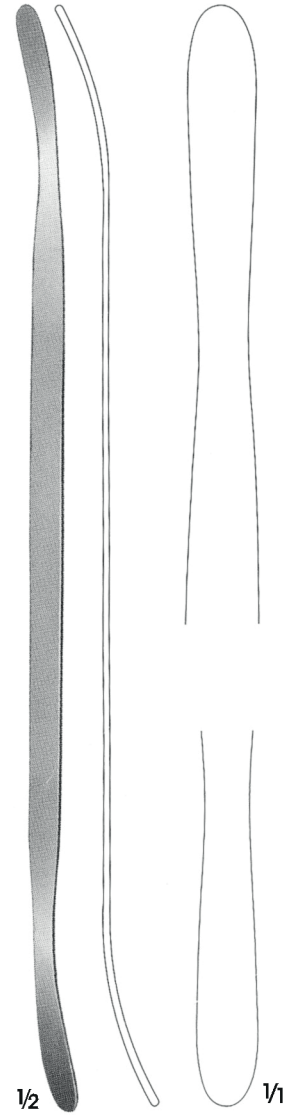

PENFIELD
EM155-00 Dissektor/Dissector
Çift uçlu, hafif eğri
Double-ended, slightly curved
29 cm

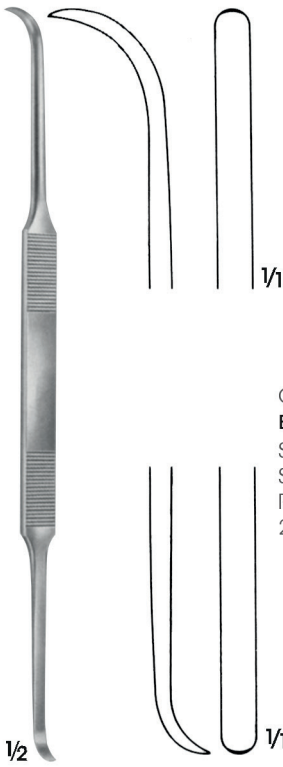

COTTLE
EM193-01
Sivri/Sharp
Sivri/Sharp
Raspa/Raspatory
20 cm



COTTLE
EM196-01
Sivri/Sharp
Sivri/Sharp
Sivri/Sharp
Elavator/Elavator
20 cm



PENNINGTON
EM197-01
Sivri/Sharp
Sivri/Sharp
Sivri/Sharp
Raspa/Raspatory
21 cm



PIERCE
EM198-01
Sivri/Sharp
Sivri/Sharp
Sivri/Sharp
Raspa/Raspatory
21 cm

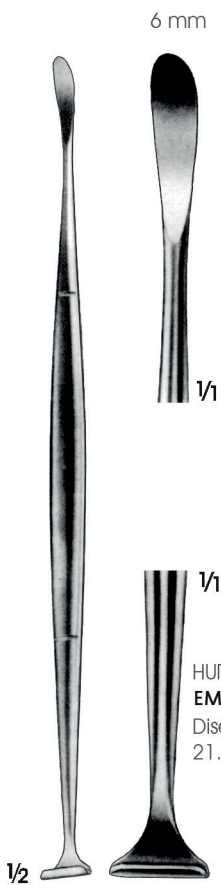

HURD
EM205-02
Disektor/Dissector
21.5 cm

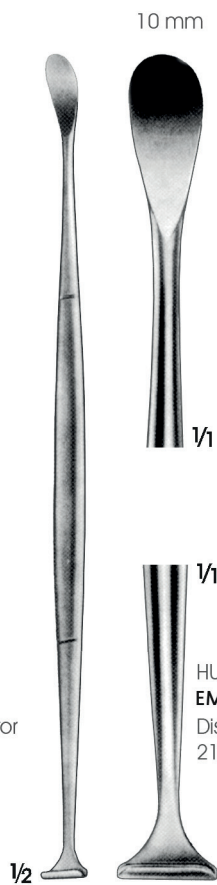

HURD
EM205-04
Disektor/Dissector
21.5 cm

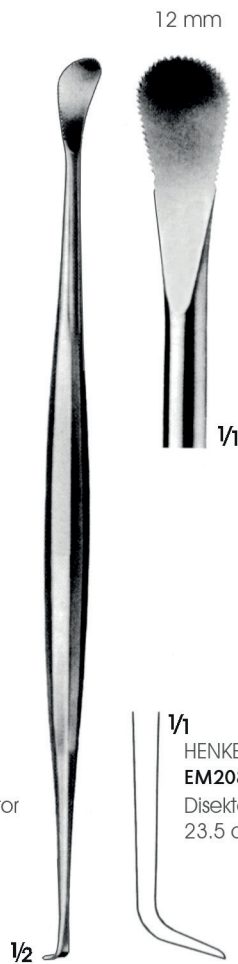

HENKE
EM208-02
Disektor/Dissector
23.5 cm

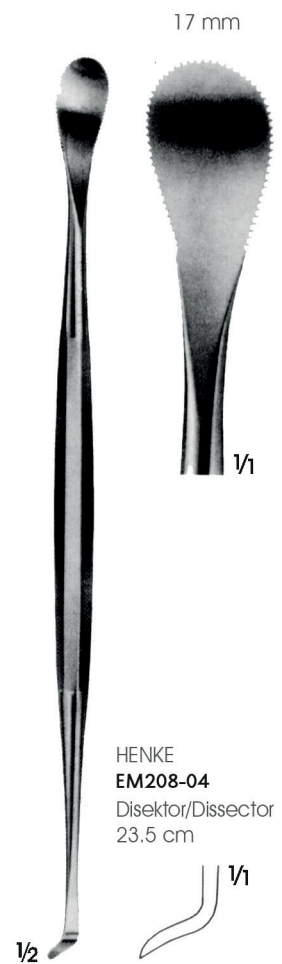

HENKE
EM208-04
Disektor/Dissector
23.5 cm



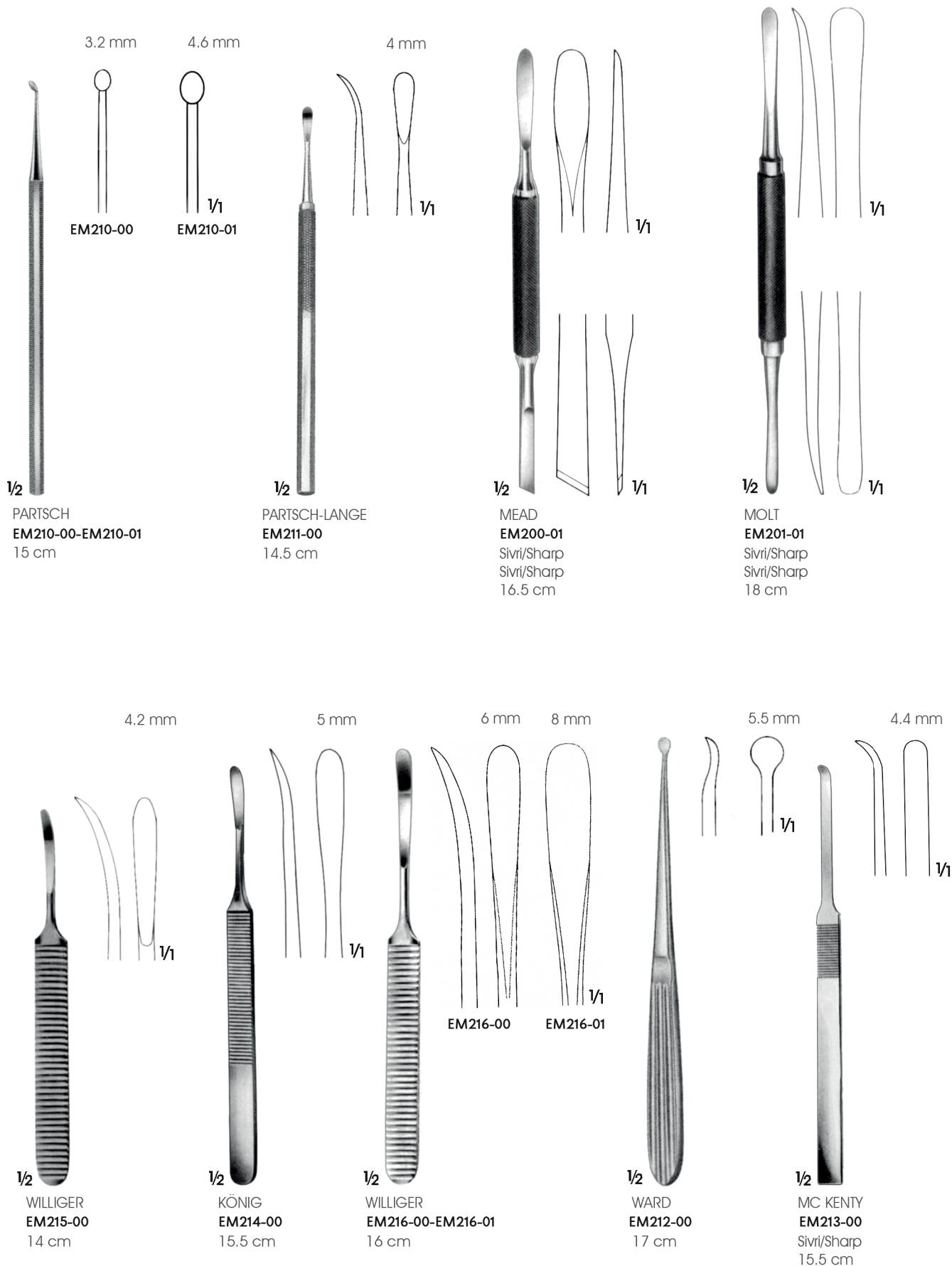

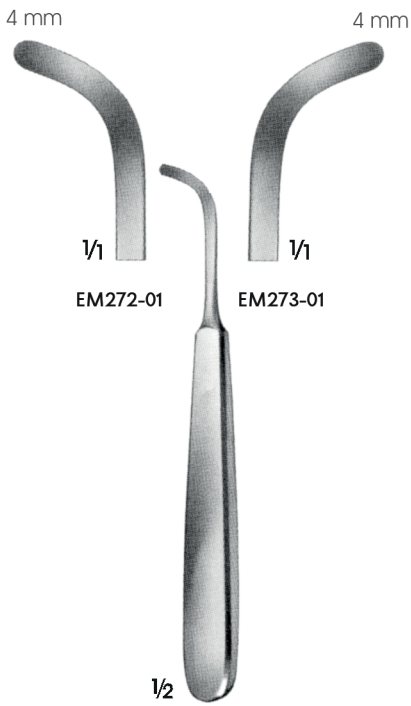

EM272-01

EM273-01

EM272-01-EM273-01
14 cm

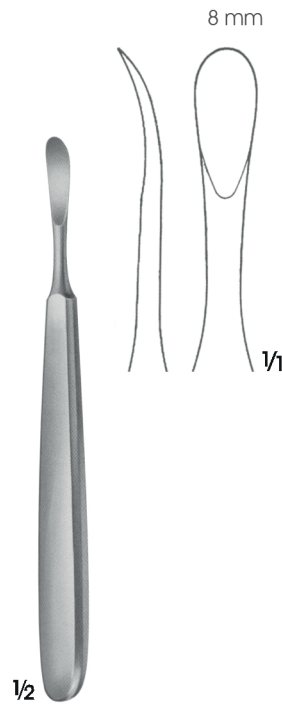

TRELAT
EM218-00
15 cm

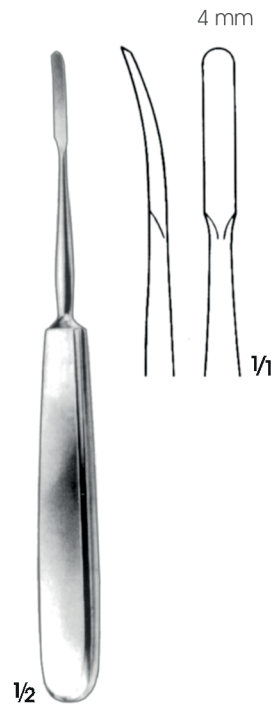

JOSEPH
EM219-01
17 cm

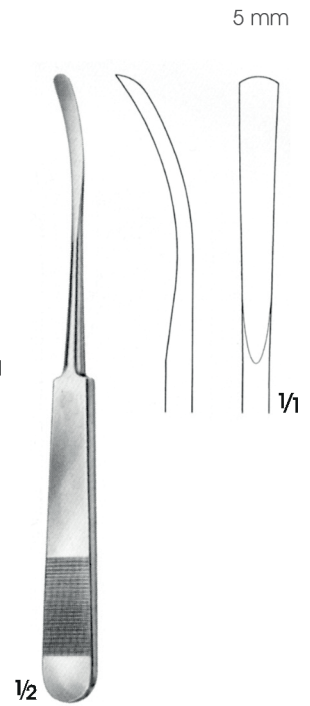

ADSON
EM237-10
16.5 cm

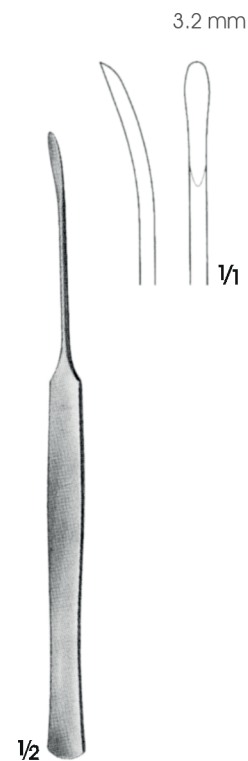
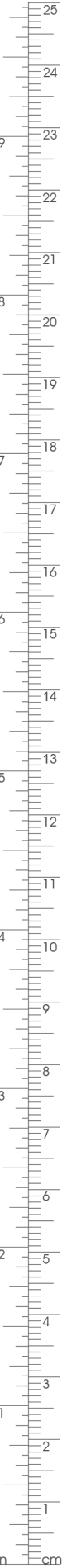

LEMPERT
EM328-01
Künt/Blunt
16.5 cm

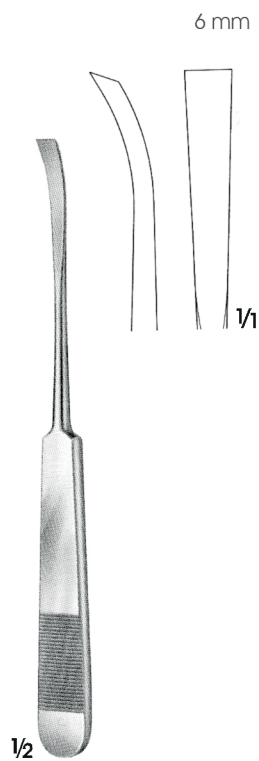

PENNYBAKER
EM328-00
Künt/Blunt
16.5 cm

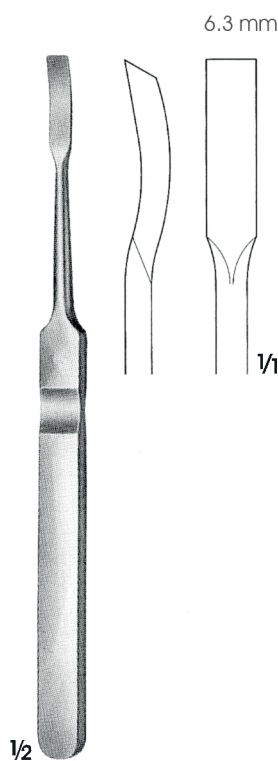

LEMPERT
EM279-00
Yarı sivri/Semi-sharp
18.5 cm

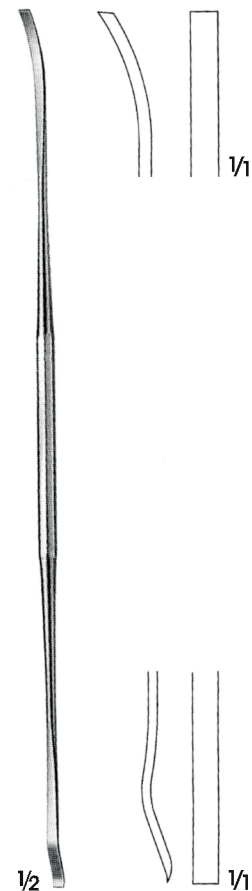

ALLEN
EM614-00
Osteofit çizil ve raspa
Osteophyte chisel and scraper
23 cm

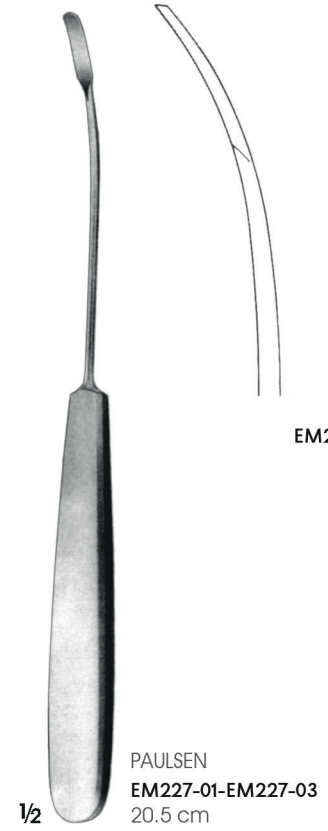
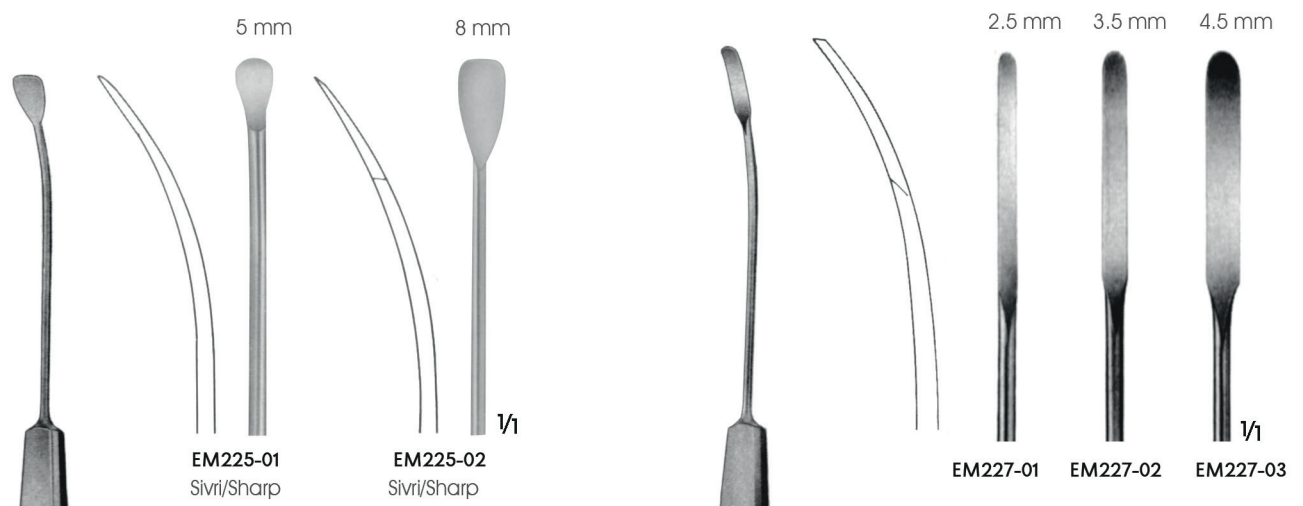
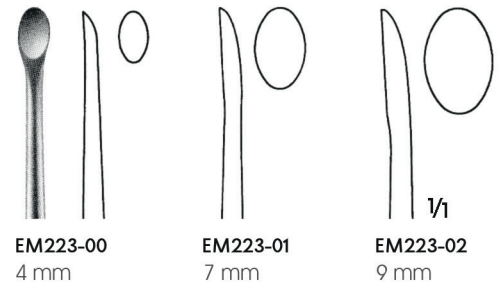
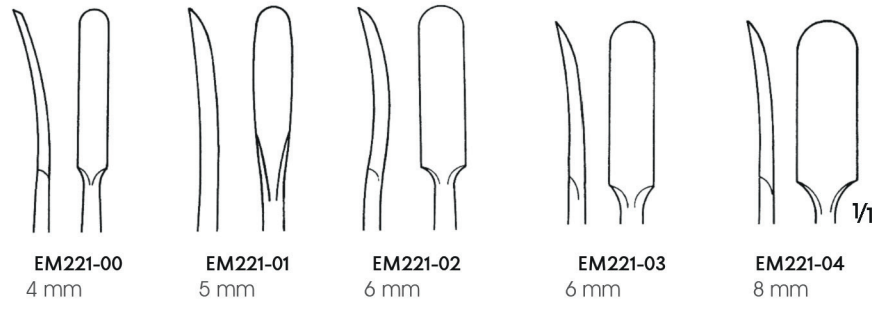
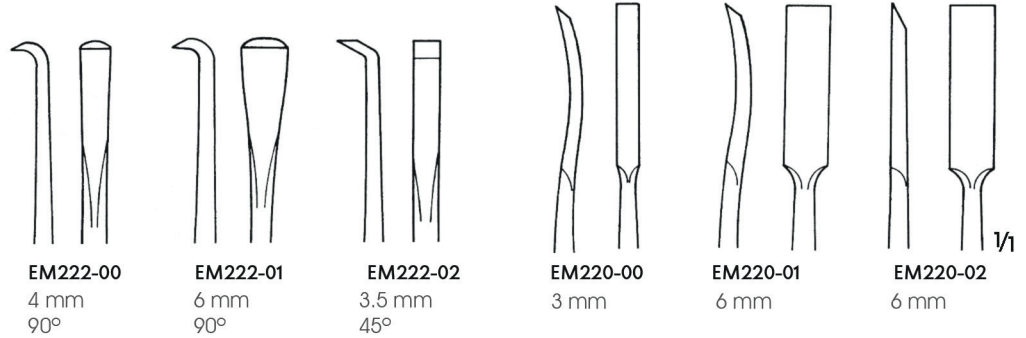

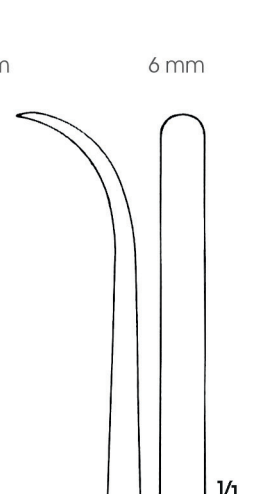
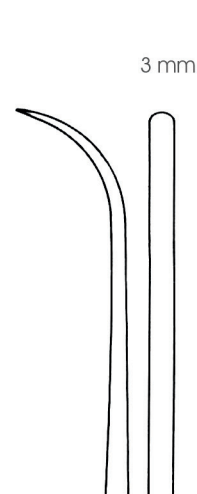
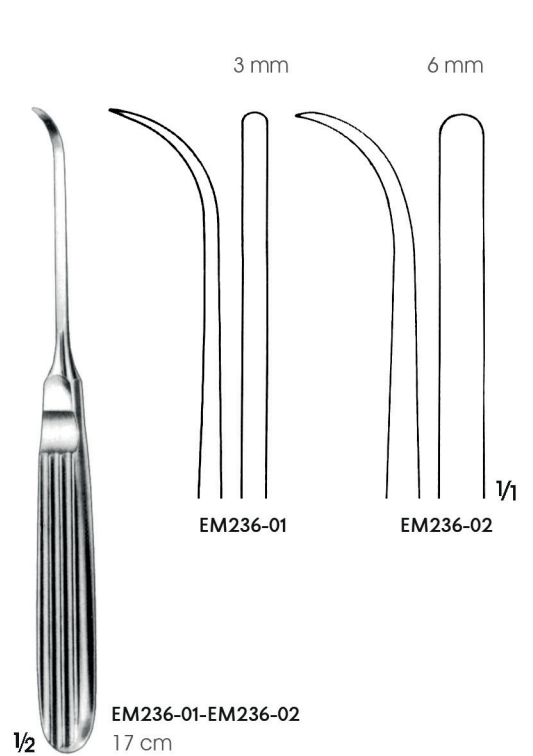
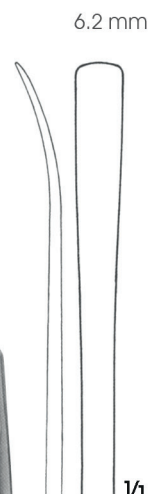
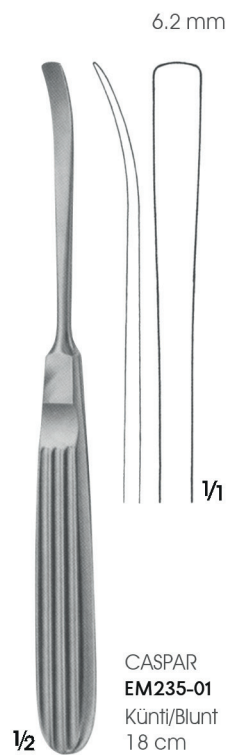
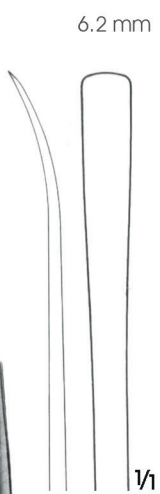
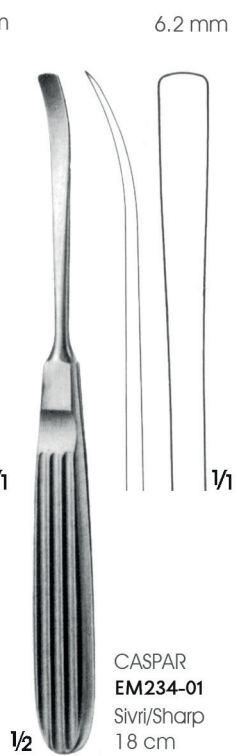
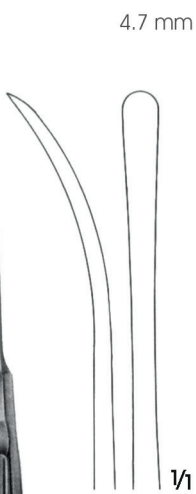
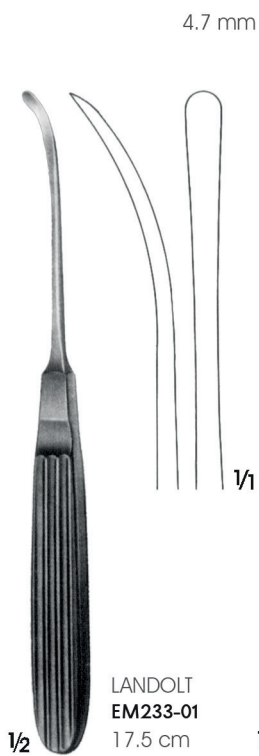
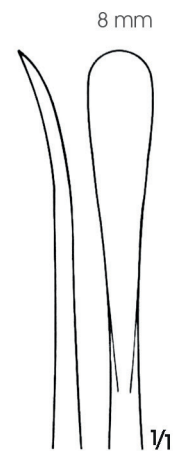
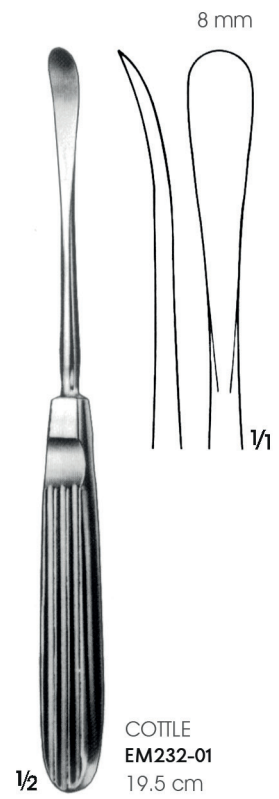
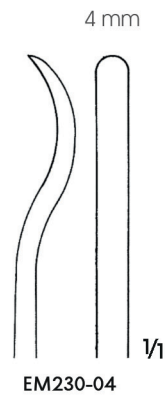
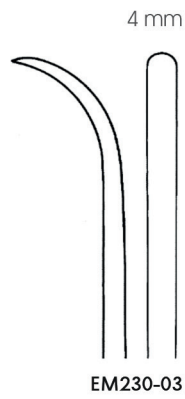
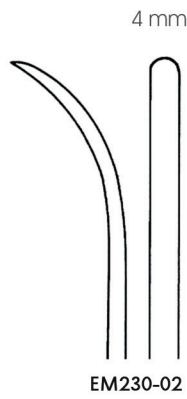
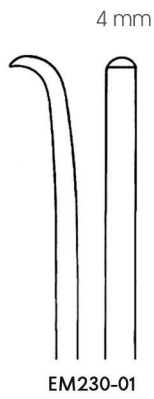
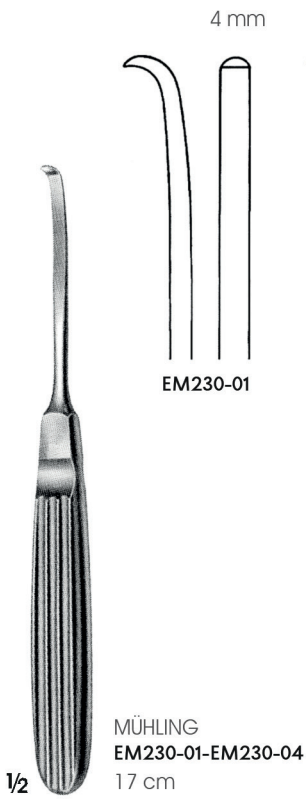

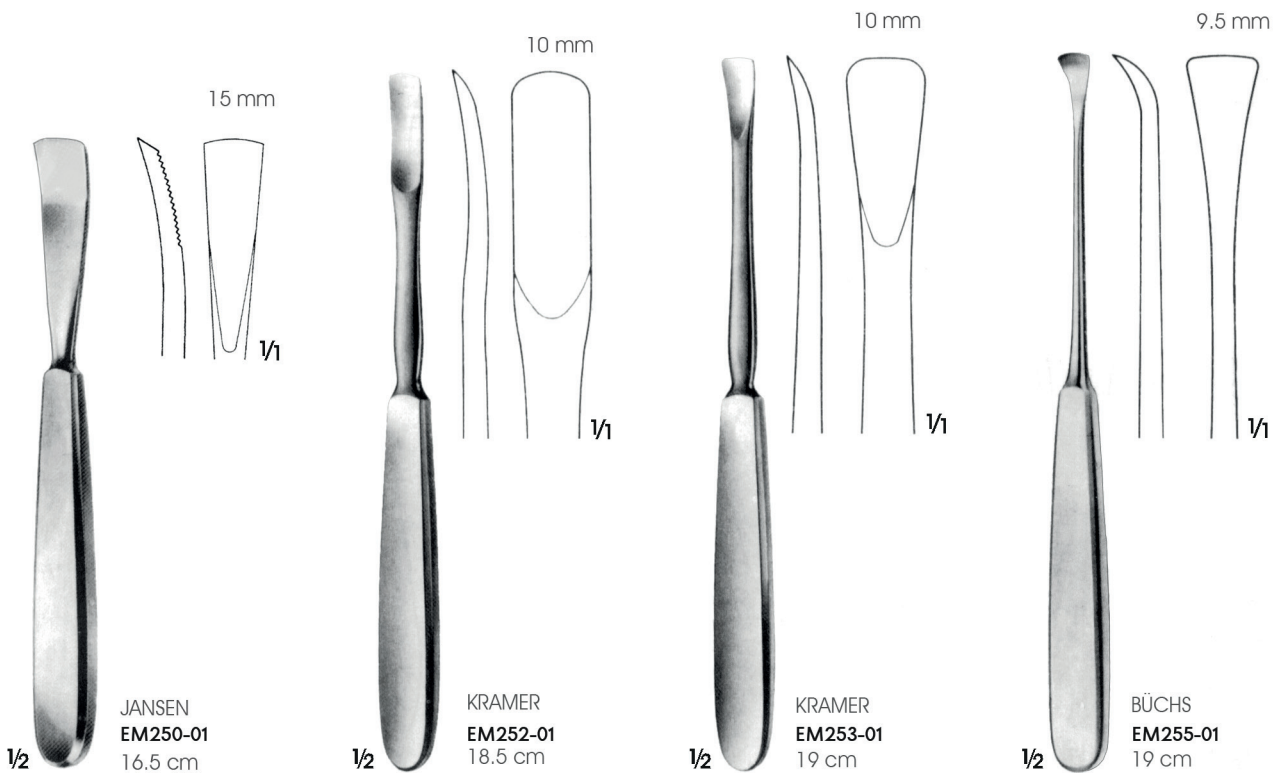
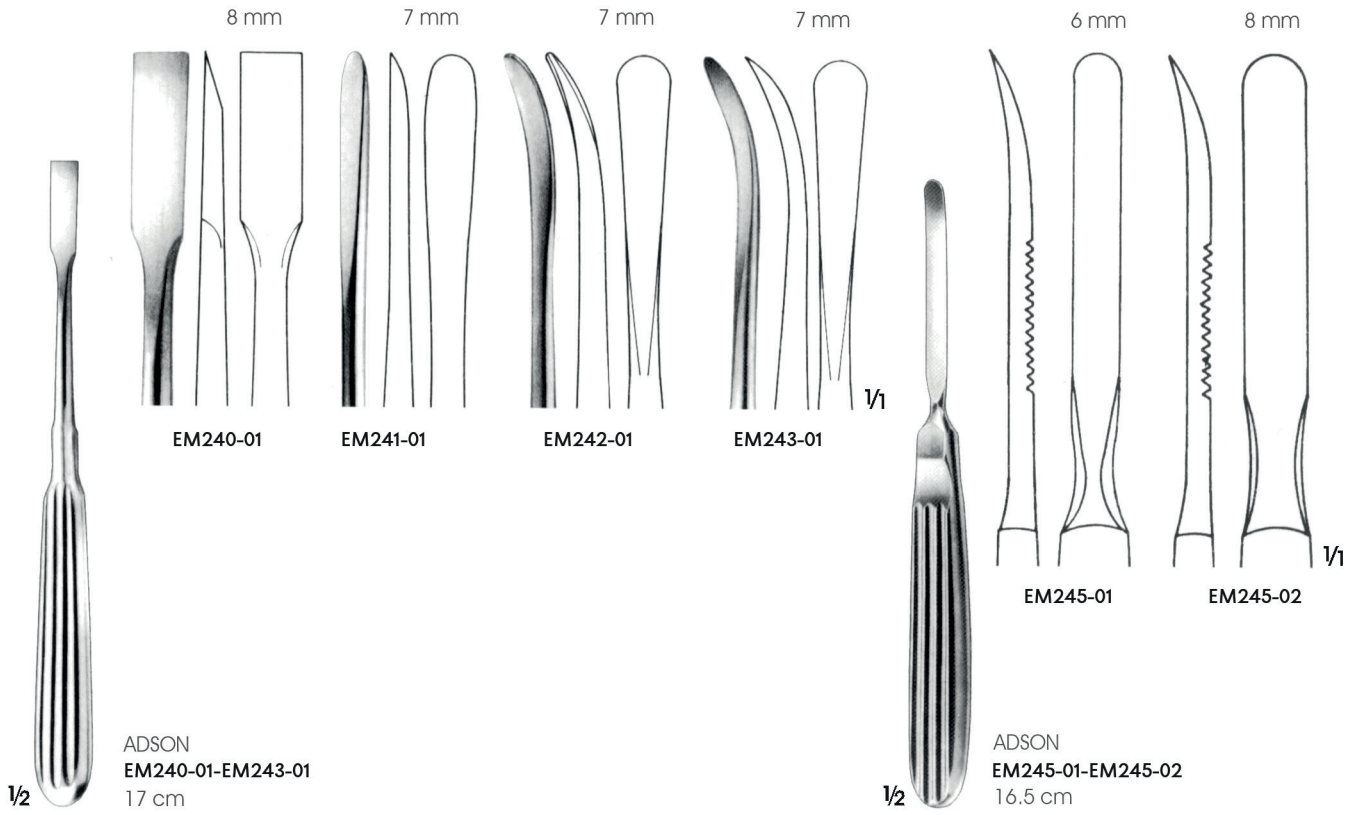

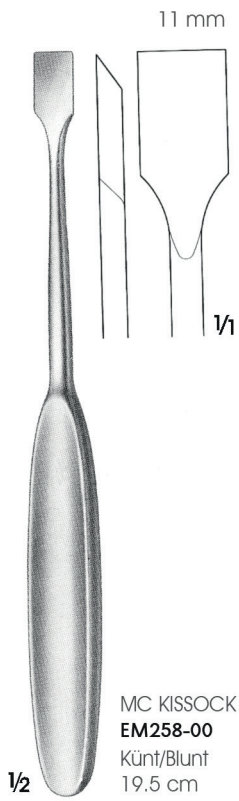

MC KISSOCK
EM258-00
Künt/Blunt
19.5 cm

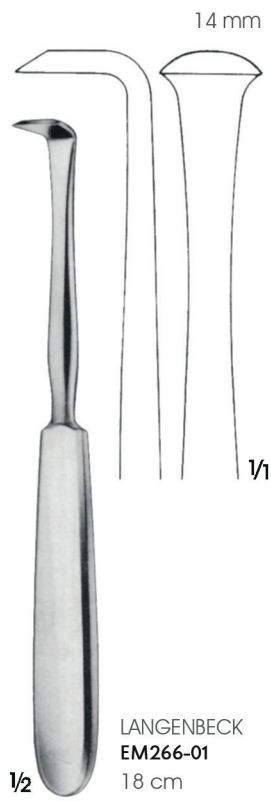

LANGENBECK
EM266-01
18 cm



SCHNEIDER
EM270-01
17.5 cm

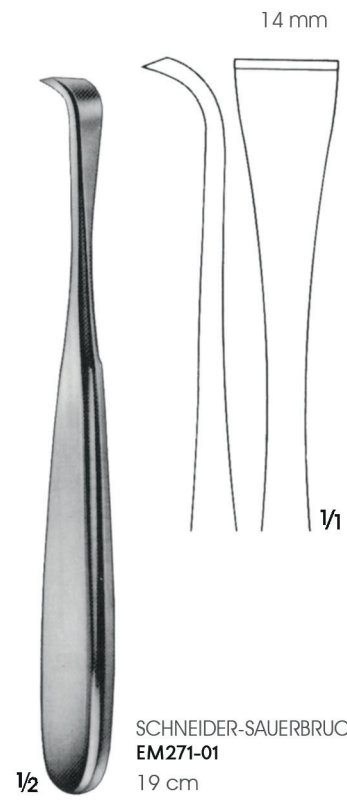

SCHNEIDER-SAUERBRUCH
EM271-01
19 cm

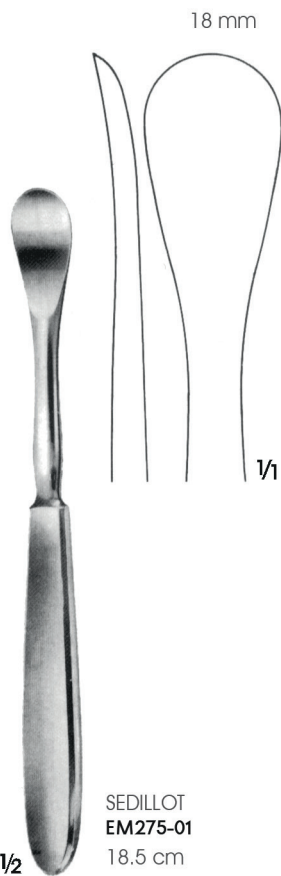

SEDILLOT
EM275-01
18.5 cm

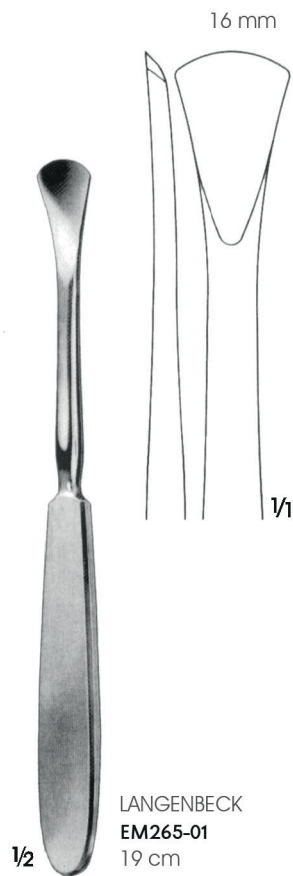

LANGENBECK
EM265-01
19 cm

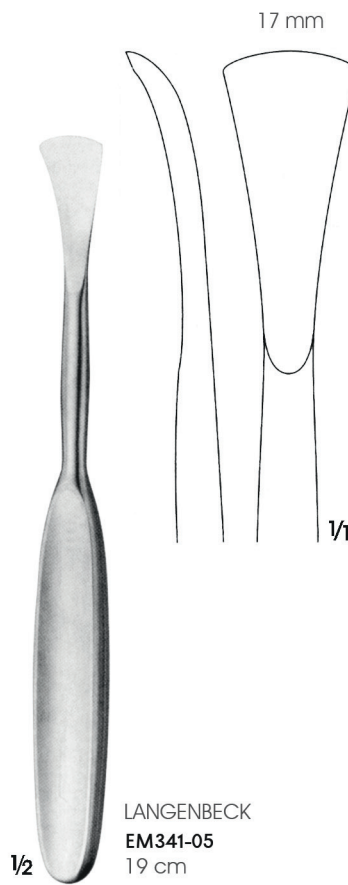

LANGENBECK
EM341-05
19 cm

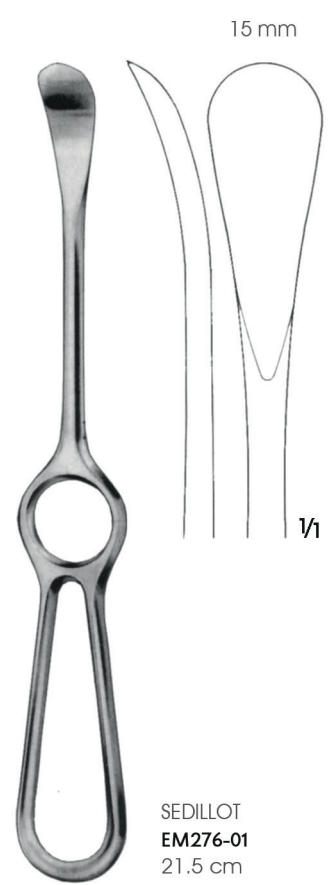

SEDILLOT
EM276-01
21.5 cm



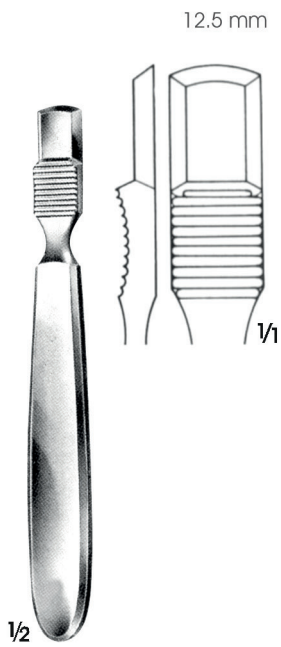

1/2
FARABEUF
EM260-00
14 cm

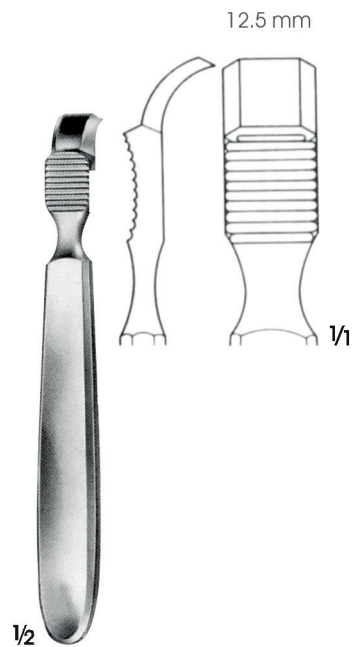

1/2
FARABEUF
EM261-00
14 cm

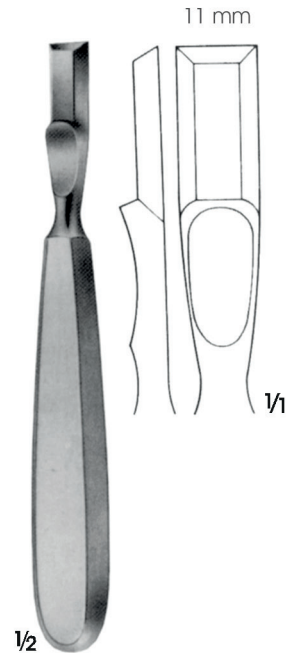

1/2
FARABEUF-COLLIN
EM263-00
16 cm

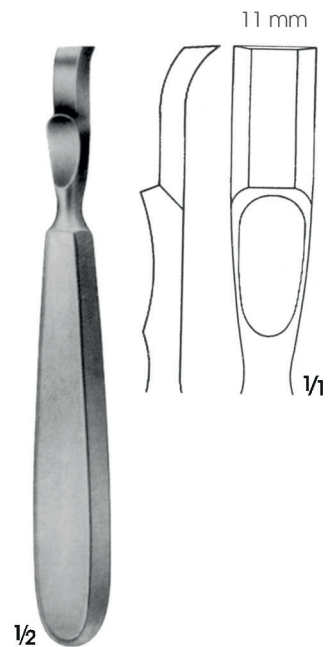

1/2
FARABEUF-COLLIN
EM264-00
16 cm

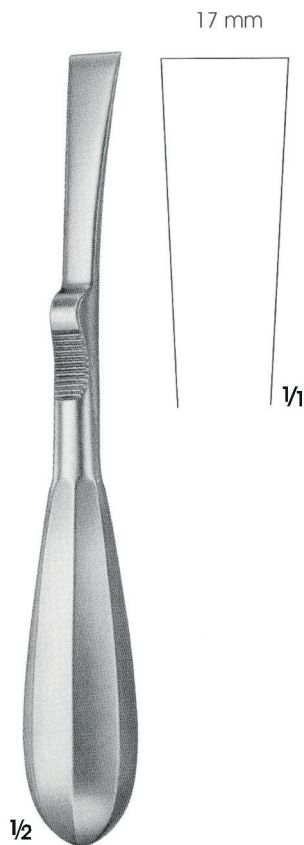

1/2
MITCHELLS
EM282-00
21 cm



1/2
LAMBOTTE
EM278-01-EM278-05
21.5 cm

- EM278-01 5 mm
- EM278-02 10 mm
- EM278-03 15 mm
- EM278-04 20 mm
- EM278-05 25 mm

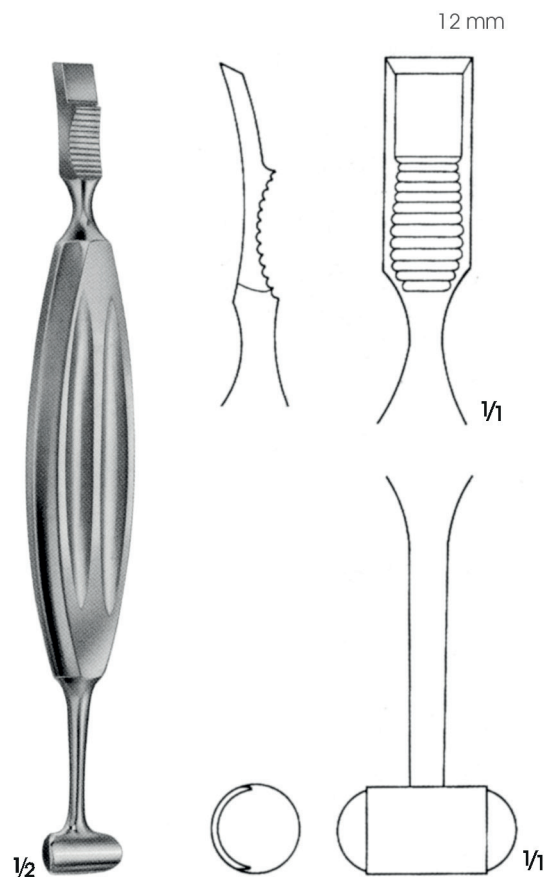

1/2
ALEXANDER
EM285-00
21 cm

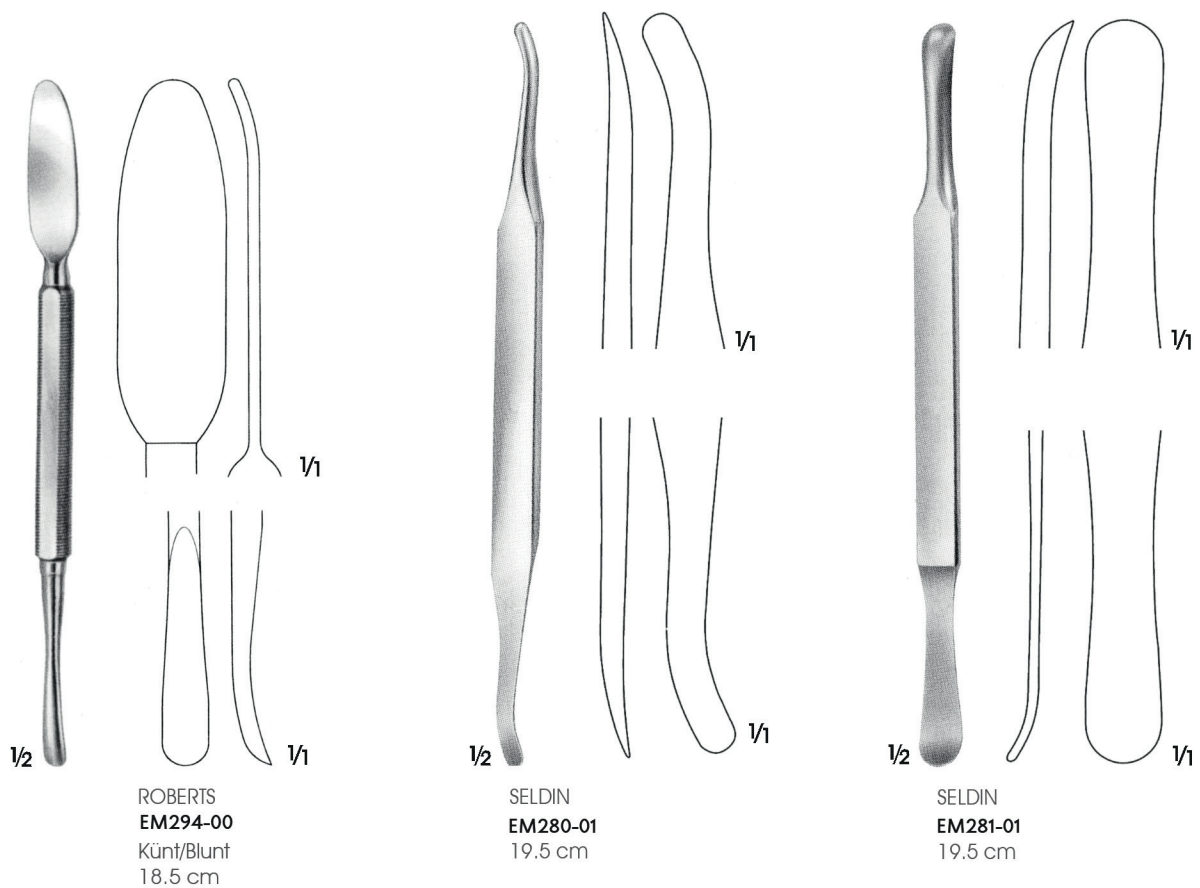
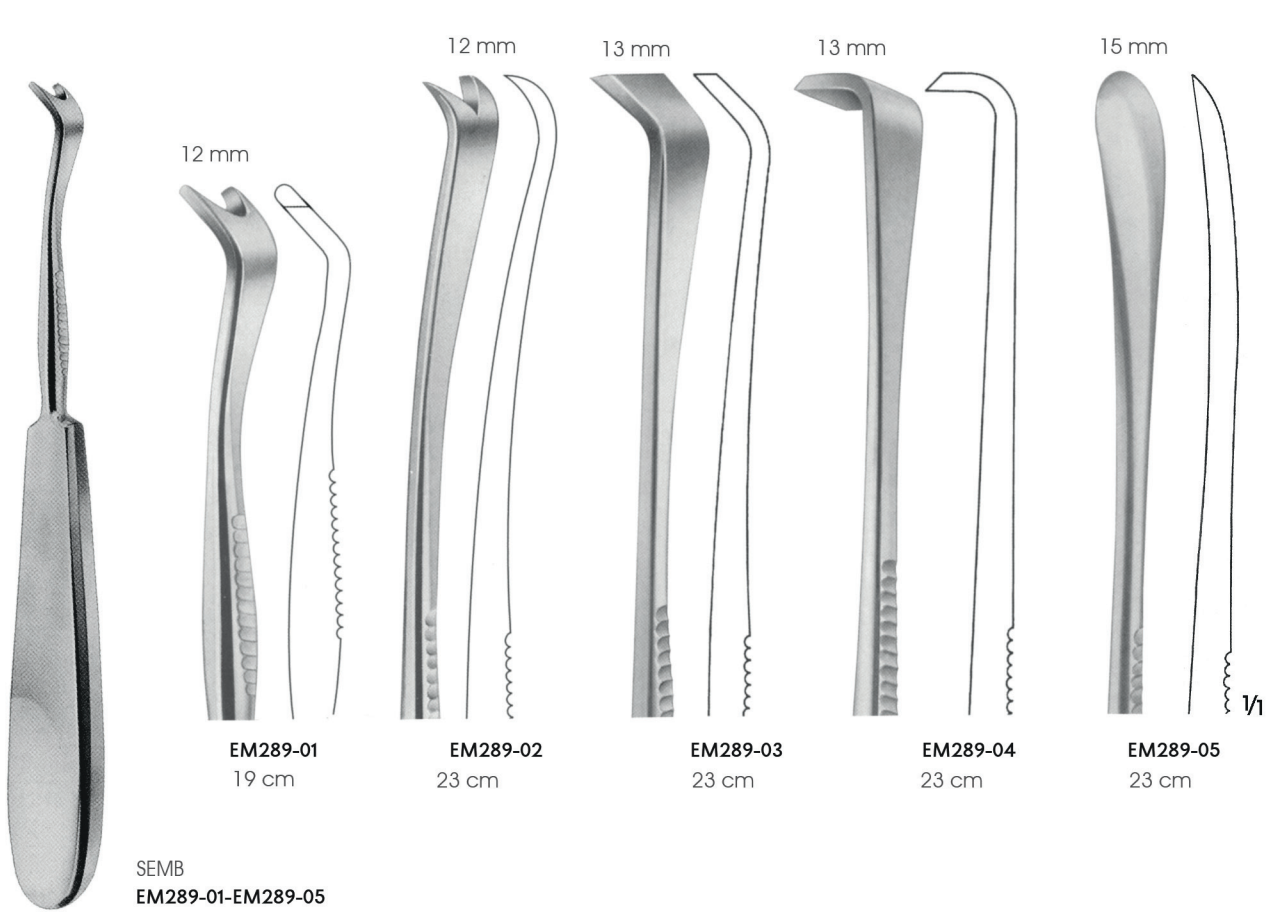

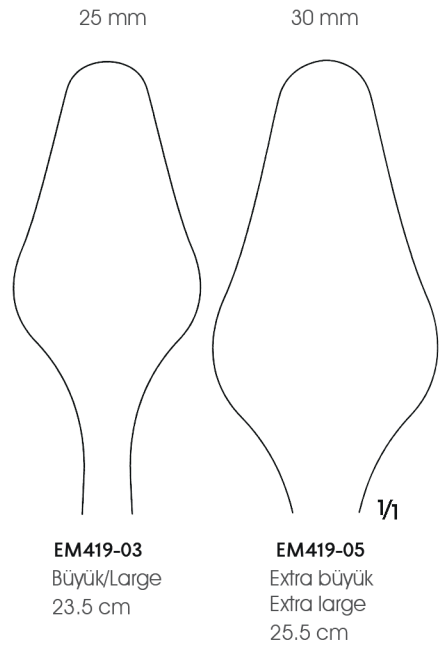
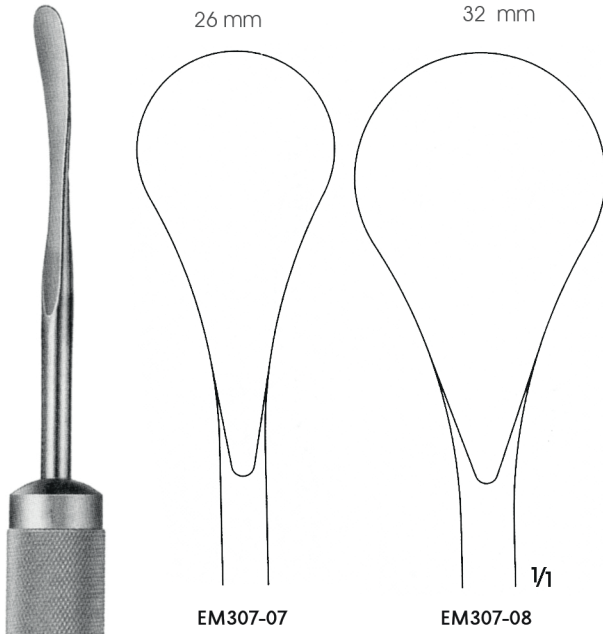
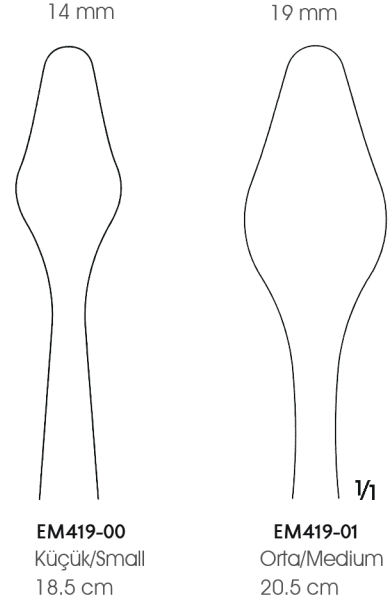
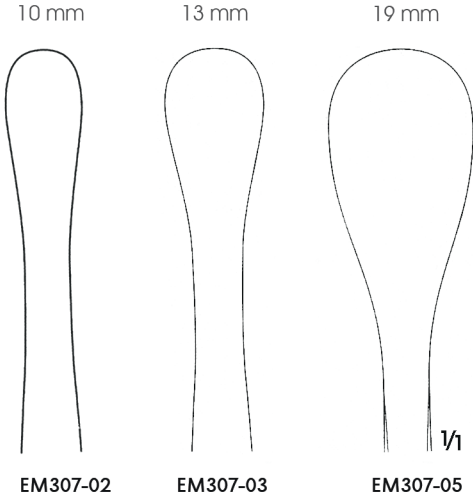

COBB
EM307-02-EM307-08
Raspa/Raspatory
28 cm

CHANDLER
EM419-00-EM419-05
Elevatör/Elevators



KEY
EM300-02-EM300-14

Genişlik Boy
Wid th Uzunluk

EM300-11	6 mm	18 cm
EM300-05	10 mm	19 cm
EM300-02	13 mm	19 cm
EM300-13	19 mm	20 cm
EM300-14	25 mm	21 cm



EM305-03



EM305-02



EM305-01



COBB
EM305-01-EM305-03
24 cm



EM306-03



EM306-02

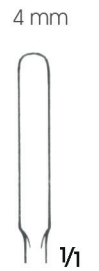

EM306-01



COBB
EM306-01-EM306-03
27 cm



143° buhar sterilizörlerinde steril edilebilir.
Can be sterilized in a steam sterilizer up to 143°

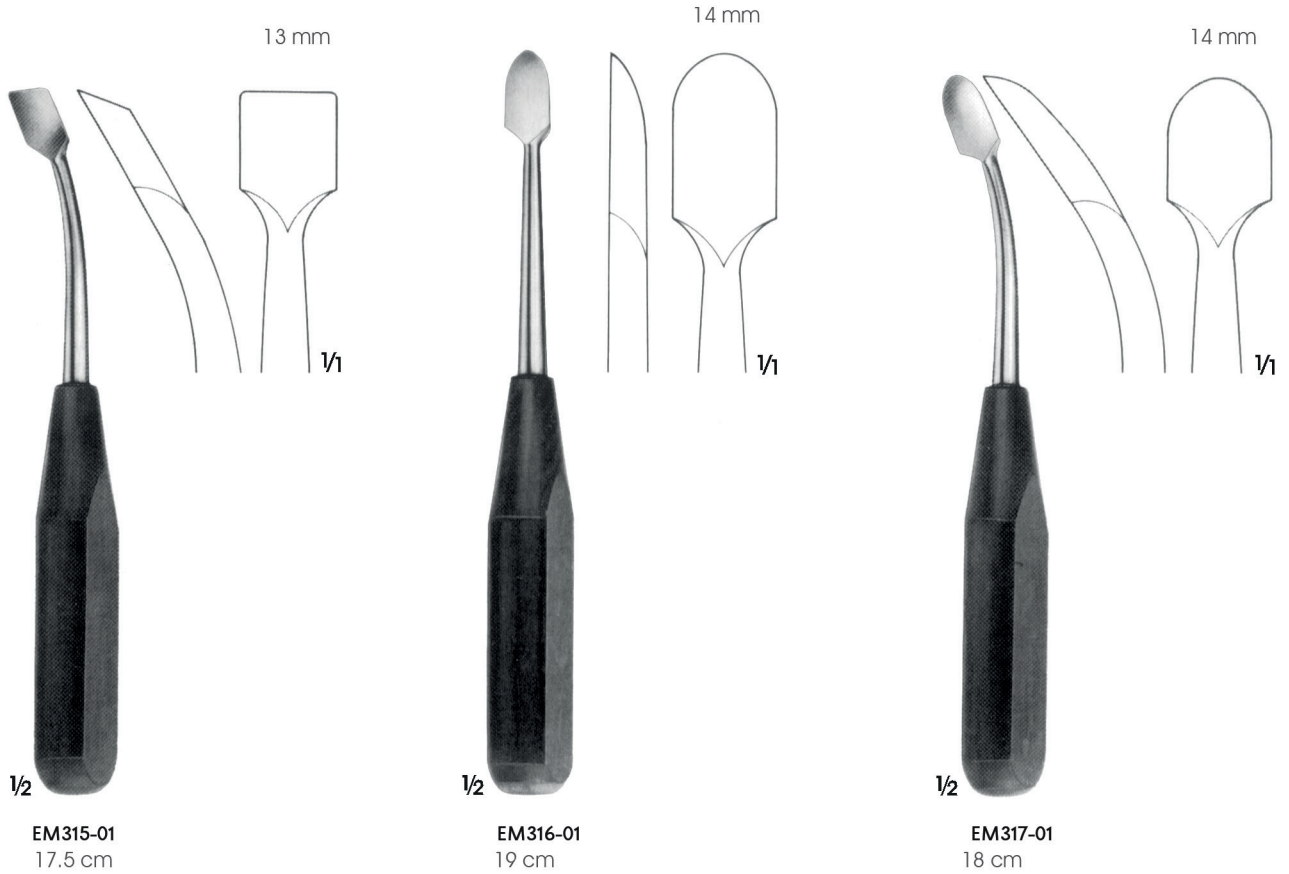
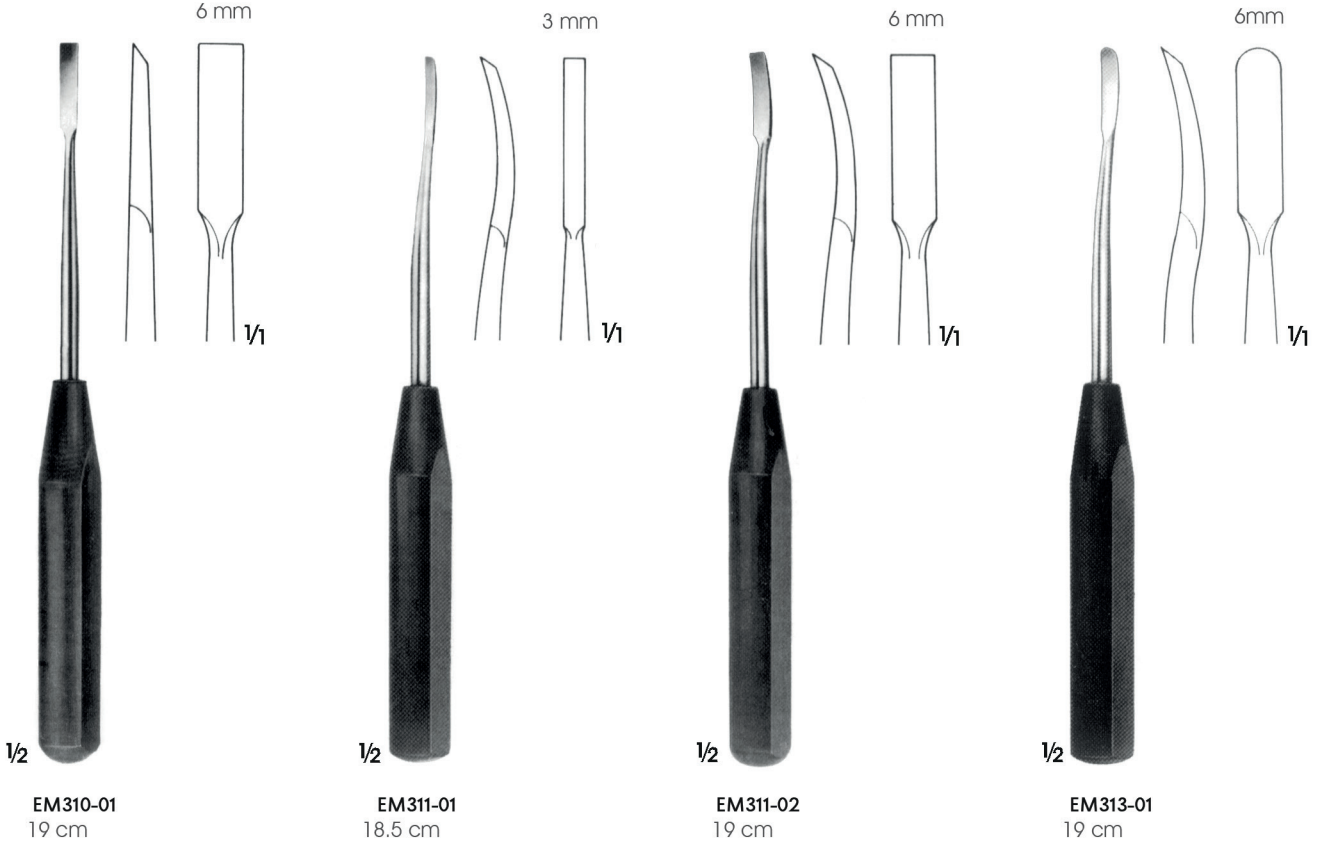

143° buhar sterilizatörlerinde steril edilebilir.
Can be sterilized in a steam sterilizer up to 143°

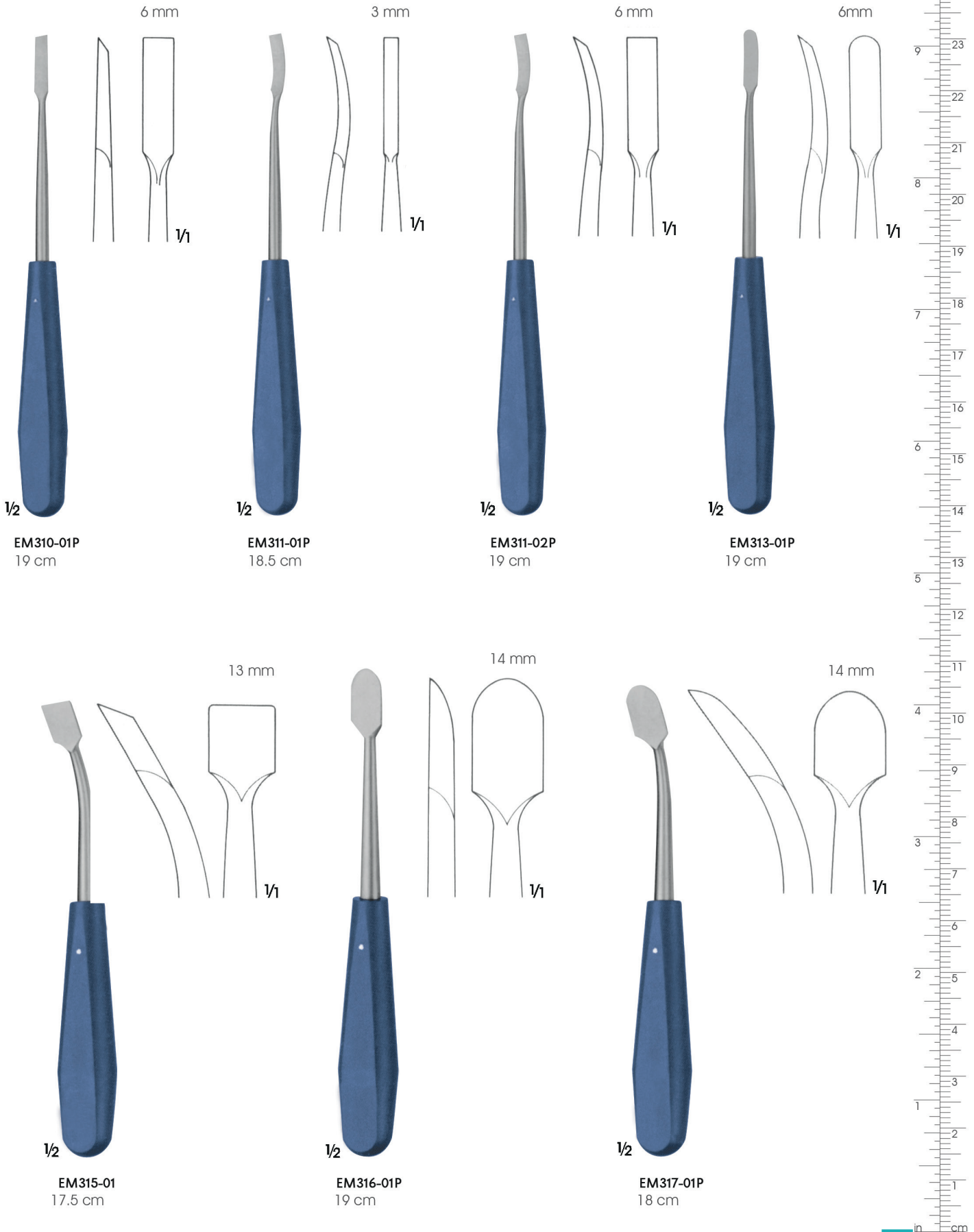



DOYEN
EM290-01-EM291-01
Çocuklar için/For children
17.5 cm

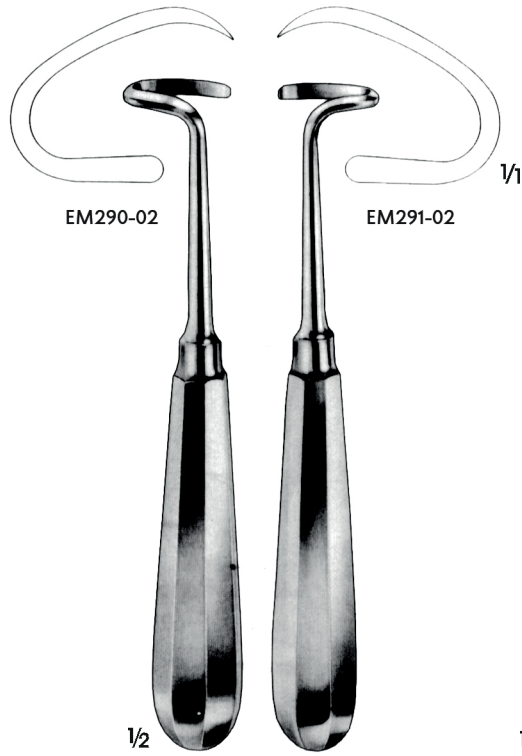

DOYEN
EM290-02-EM291-02
Yetişkimler için/For adults
17.5 cm

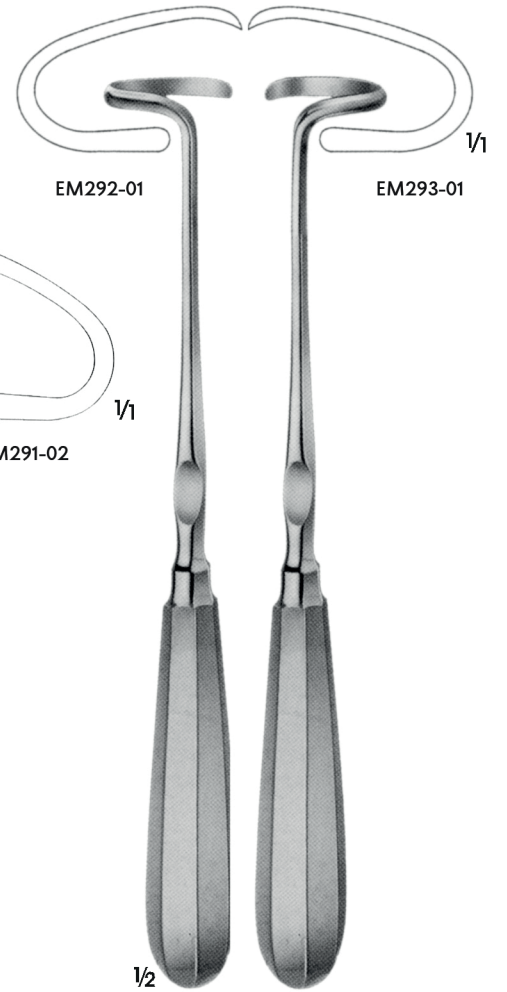

DOYEN
EM292-01-EM293-01
24 cm

143° buhar sterilizatörlerin de steril edilebilir.
Can be sterilized in a steam sterilizer up to 143°

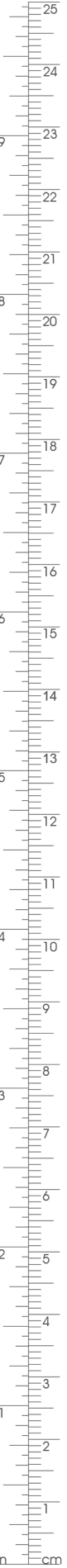
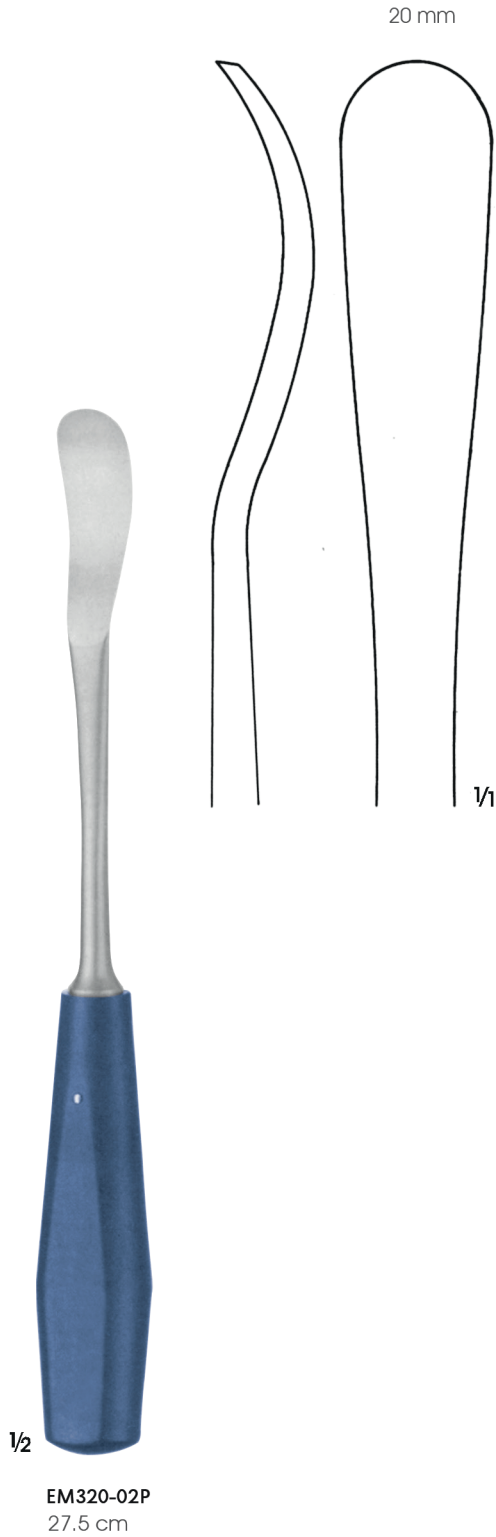

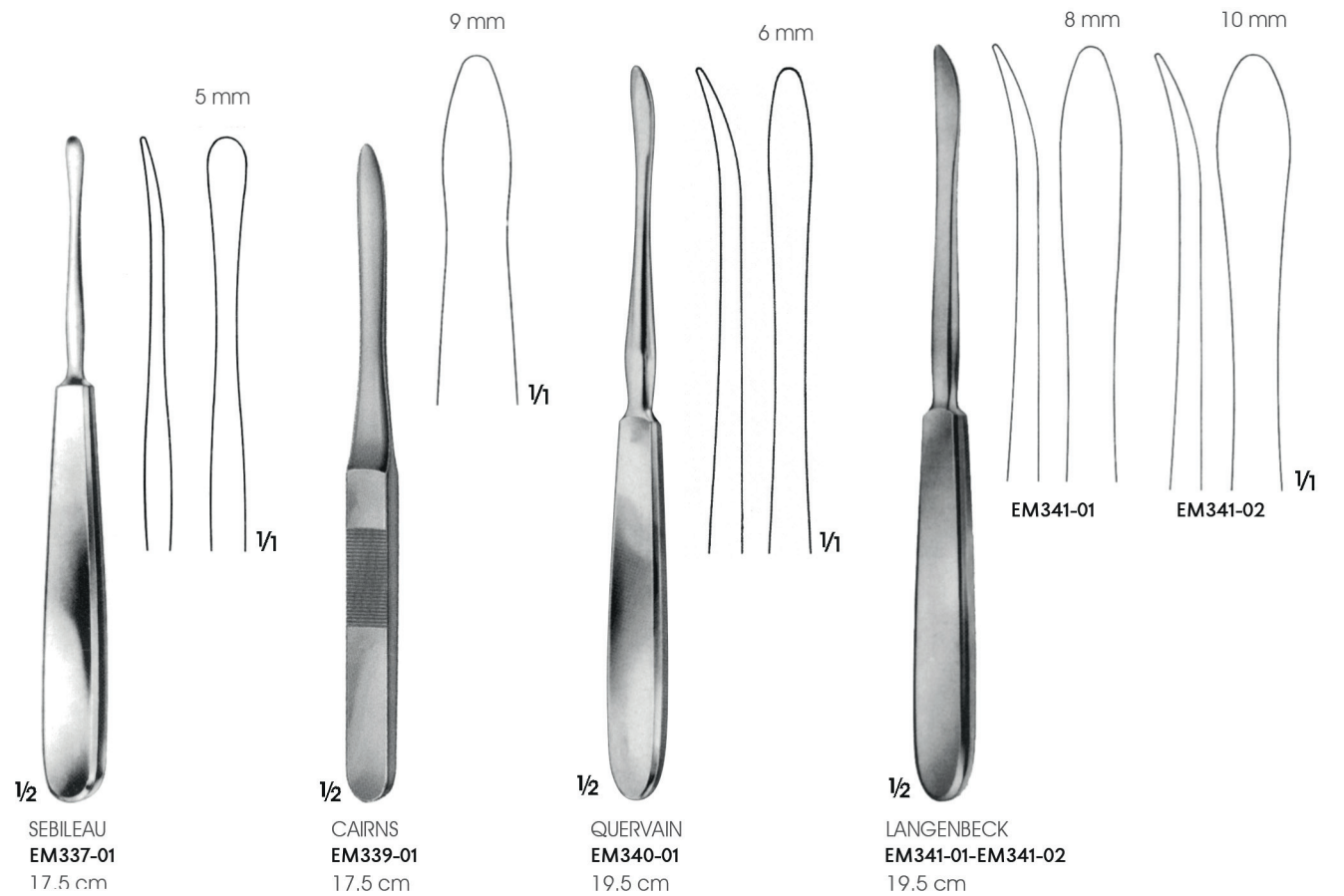
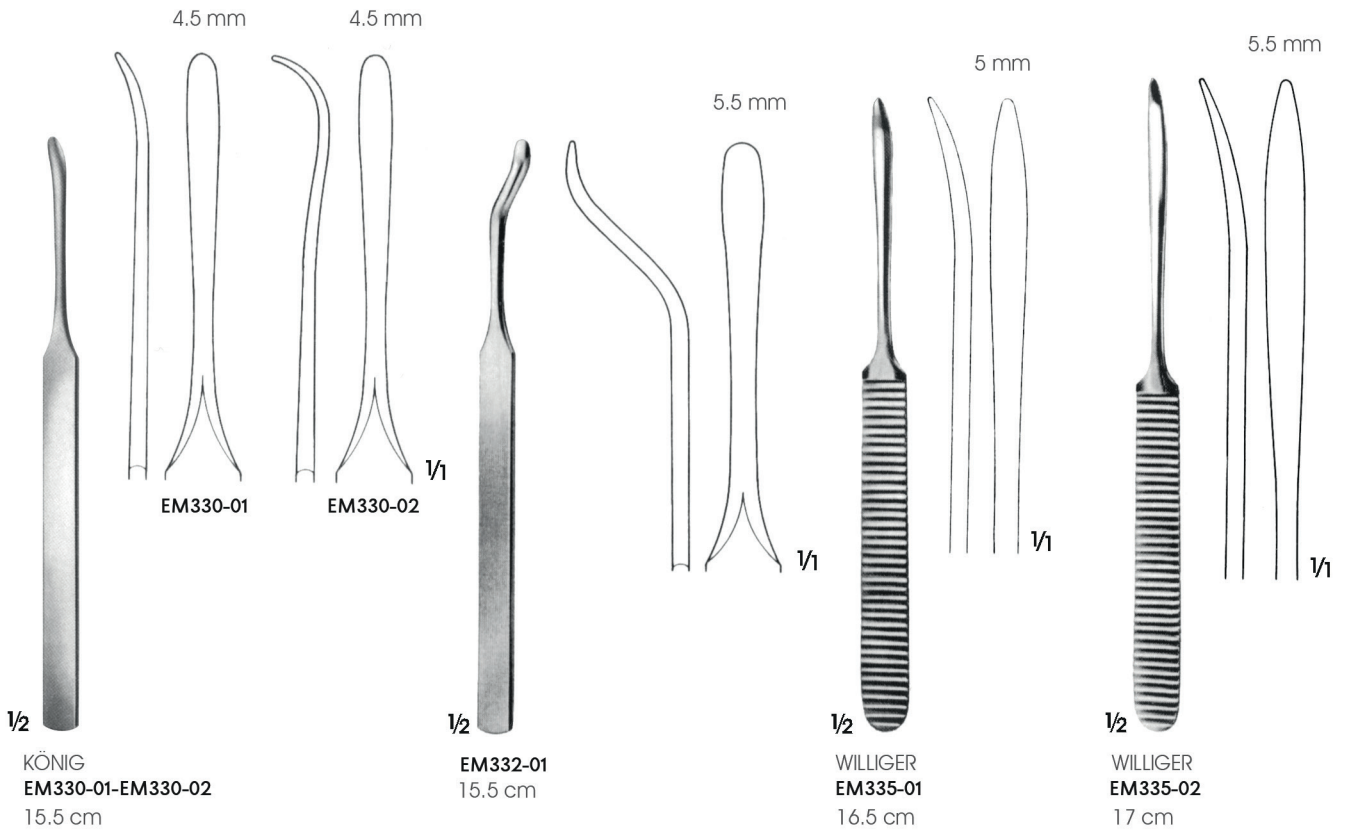

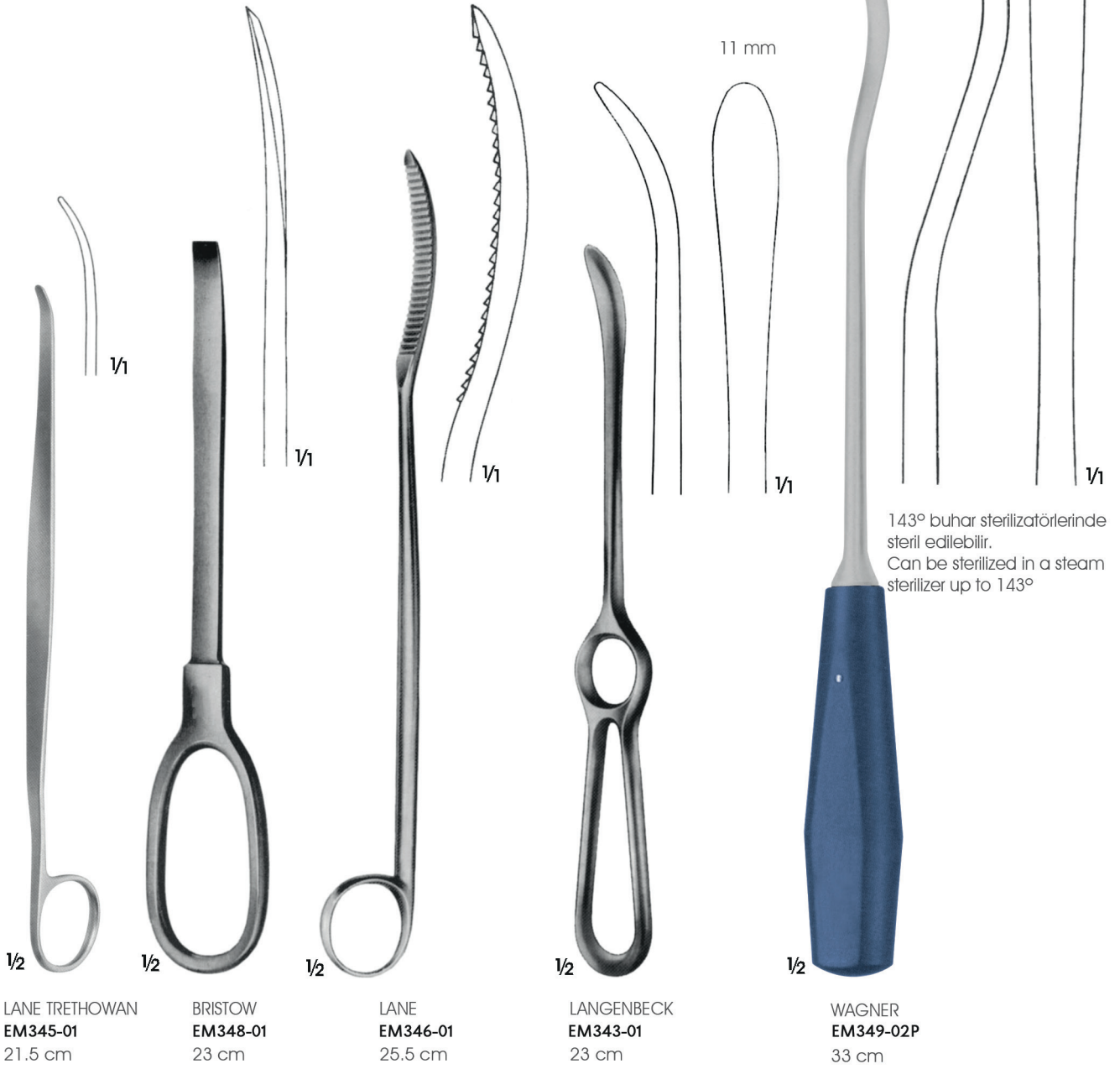

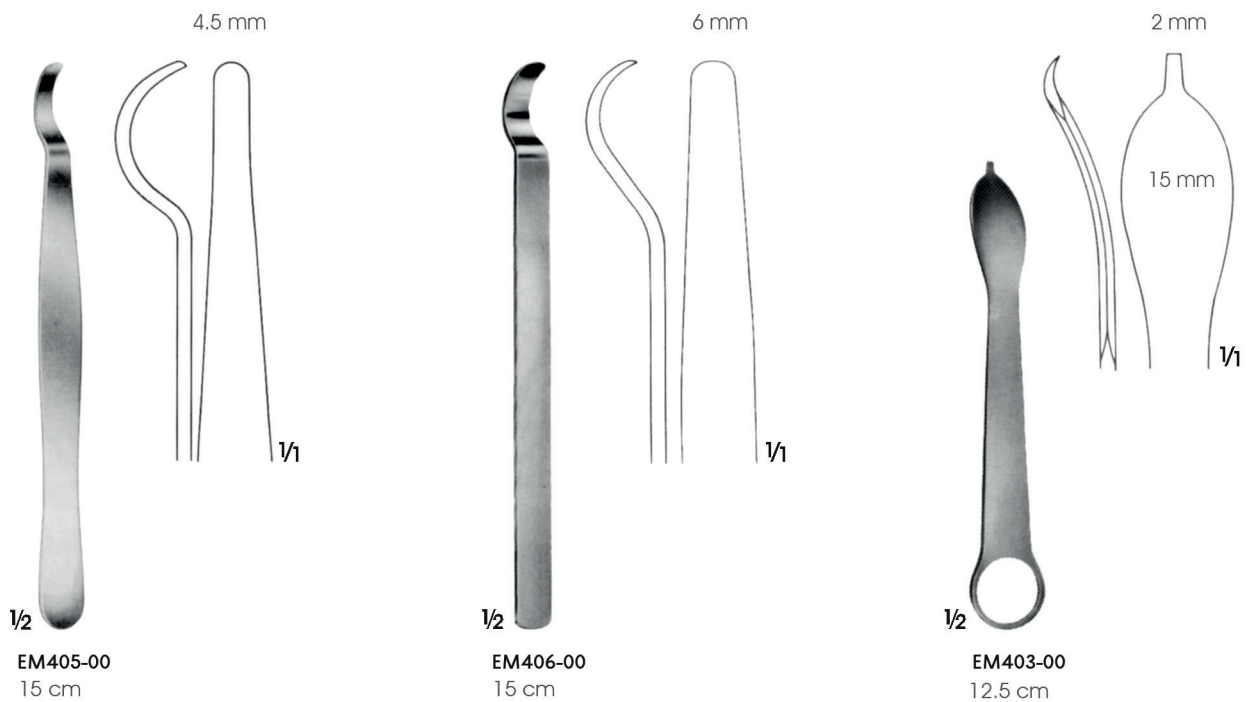
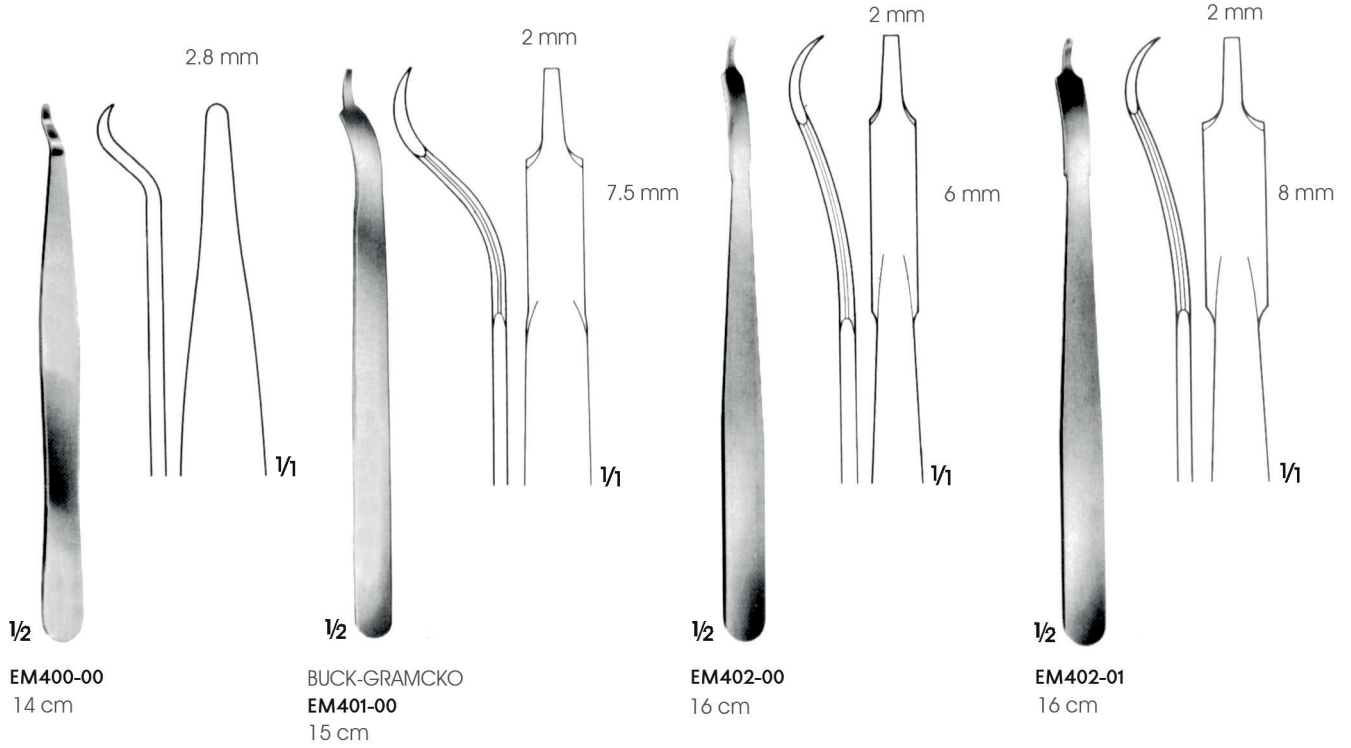

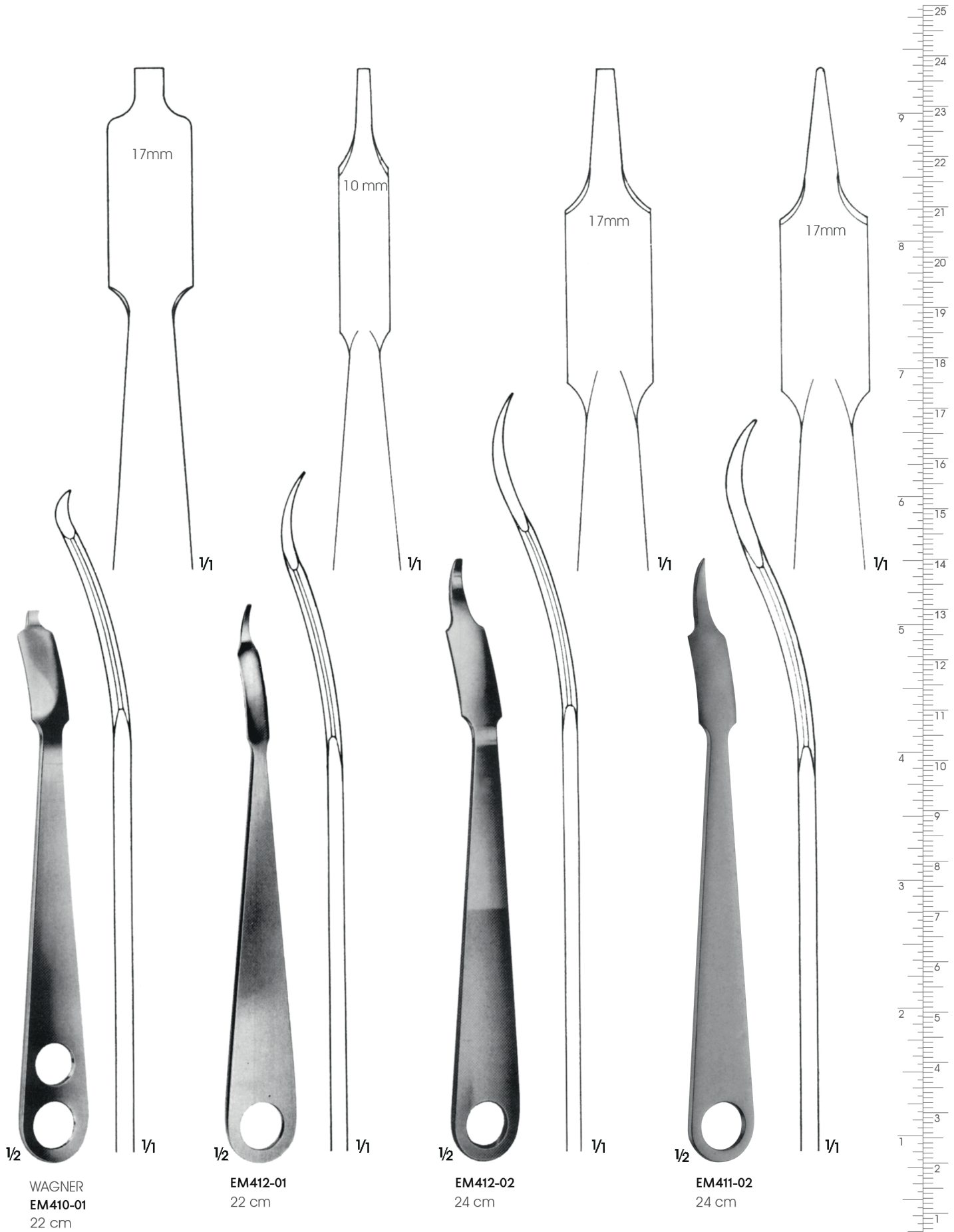



1/2

VATSON-JONES
EM407-01
28 cm

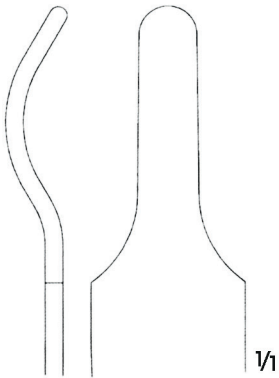

1/1



1/2

EM408-01
22 cm



8 mm

1/1

1/1

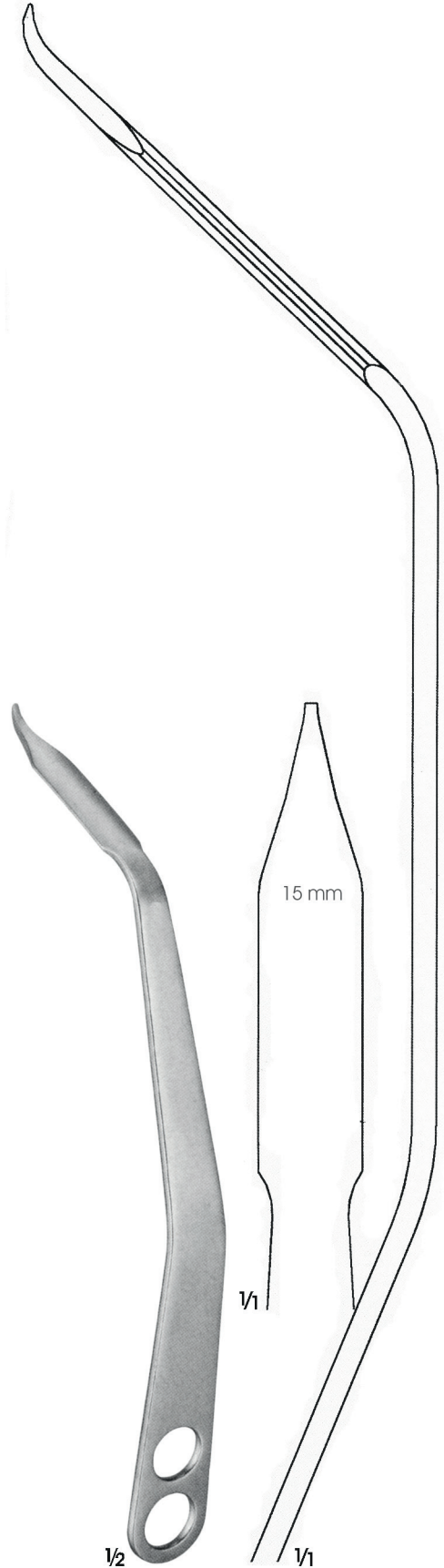

1/2

EM426-01
25 cm

15 mm

1/1

1/1

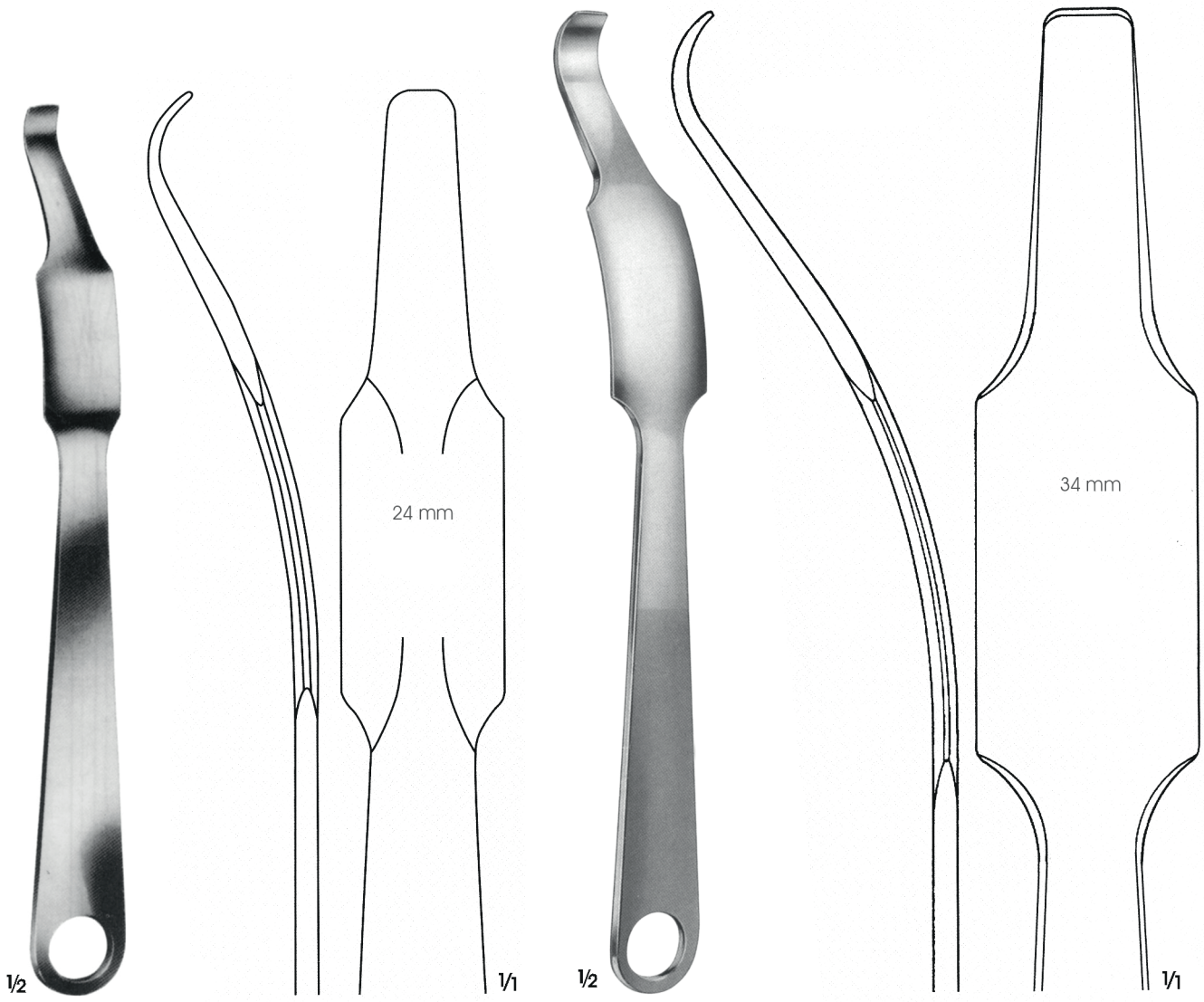

1/2

HOHMANN
EM413-01
26 cm

1/1

1/2

HOHMANN
EM413-03
28.5 cm

1/1

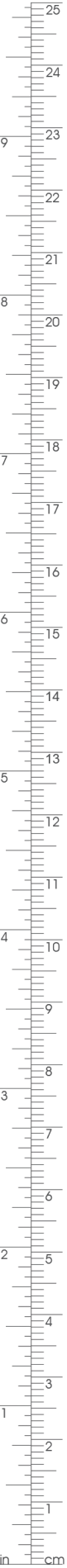

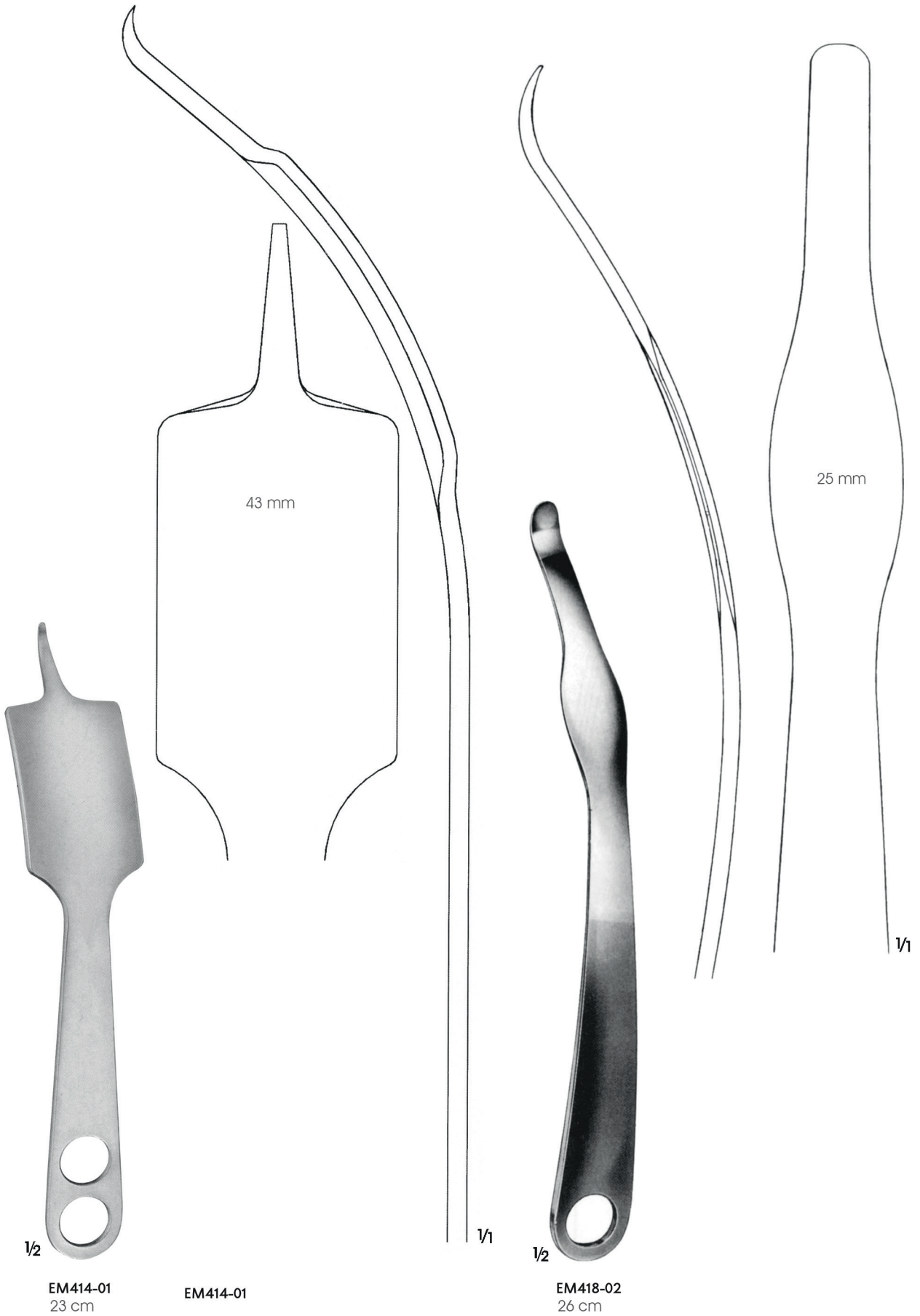

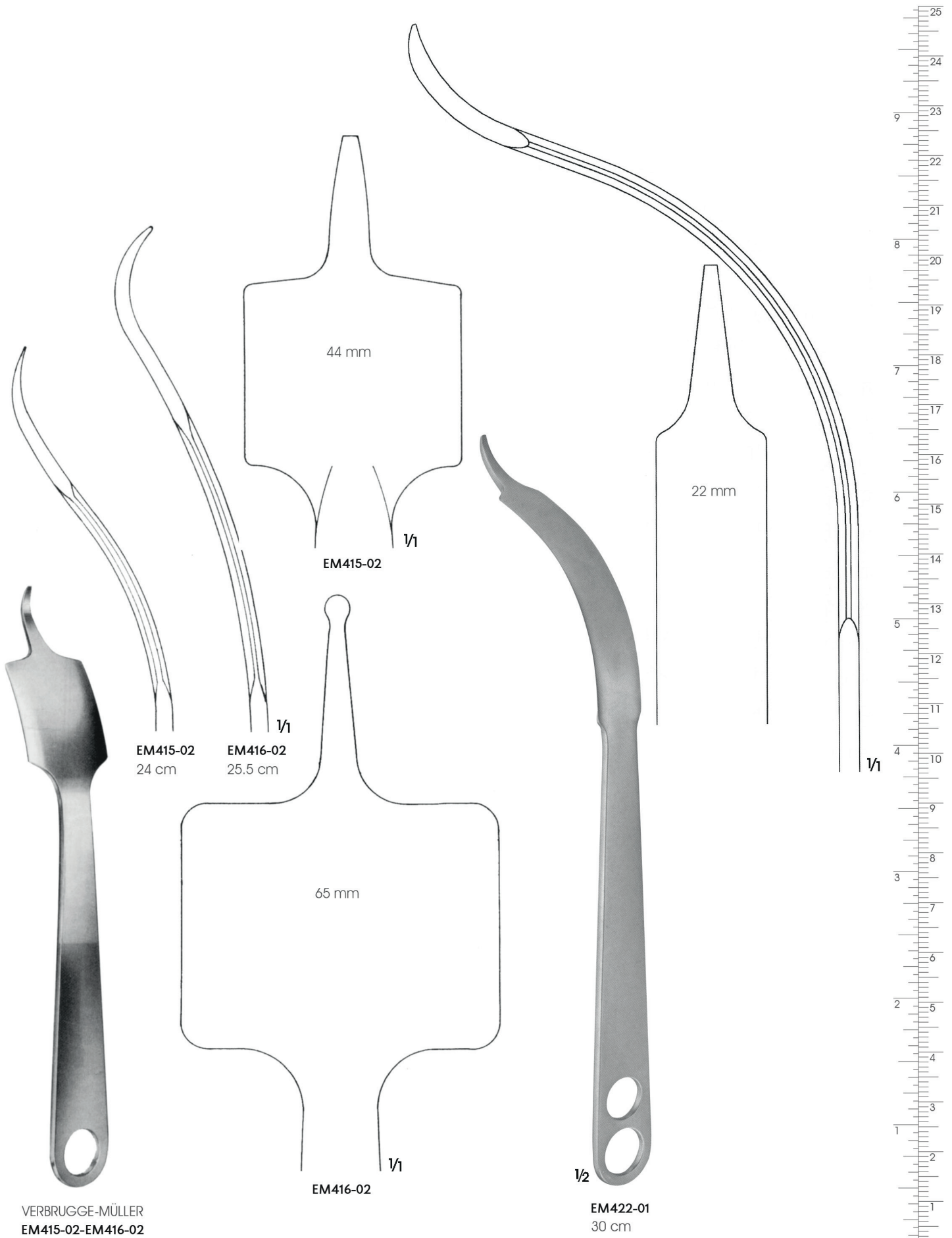

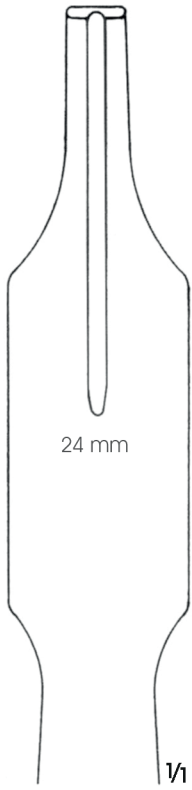

24 mm

1/4



1/2

LANGE-HOHMANN
EM420-02
25 cm

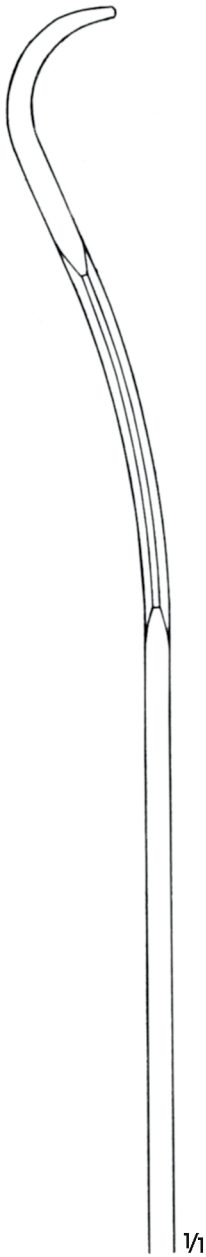

1/4



1/2

LANGE-HOHMANN
EM421-02 26.5 cm
EM421-03 28 cm

EM421-02
30 mm

EM421-03
33 mm

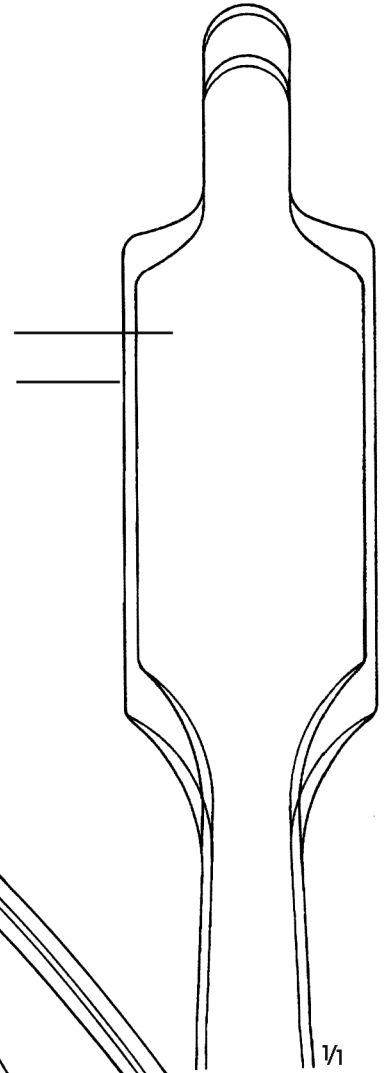

1/4

EM421-02

EM421-03

1/4

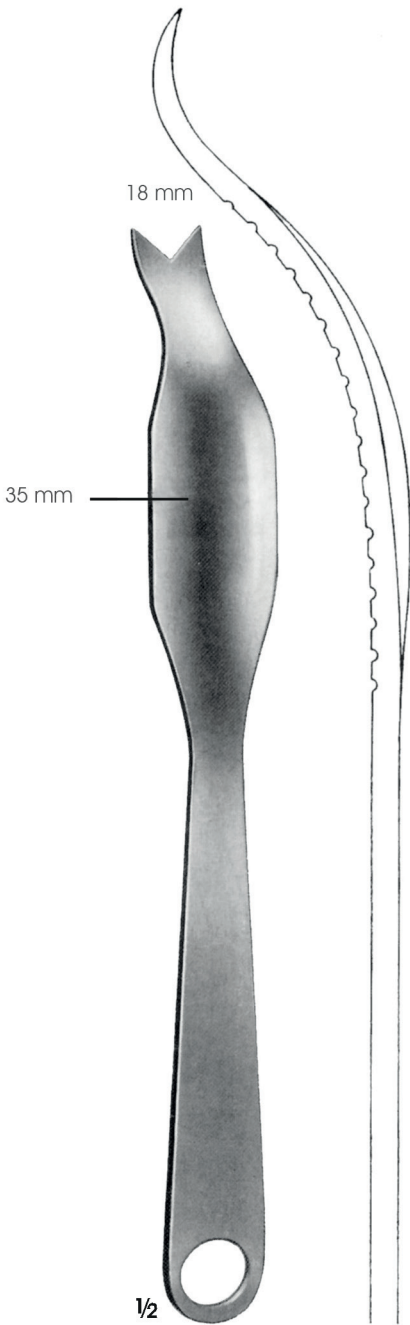

SCHUMACHER
EM423-02
29 cm

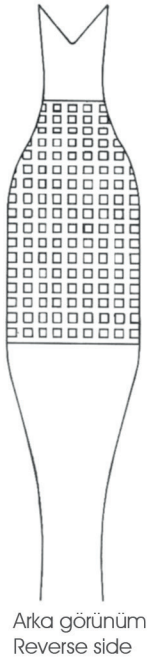

SCHUMACHER-WAGNER
EM424-02
35.5 cm



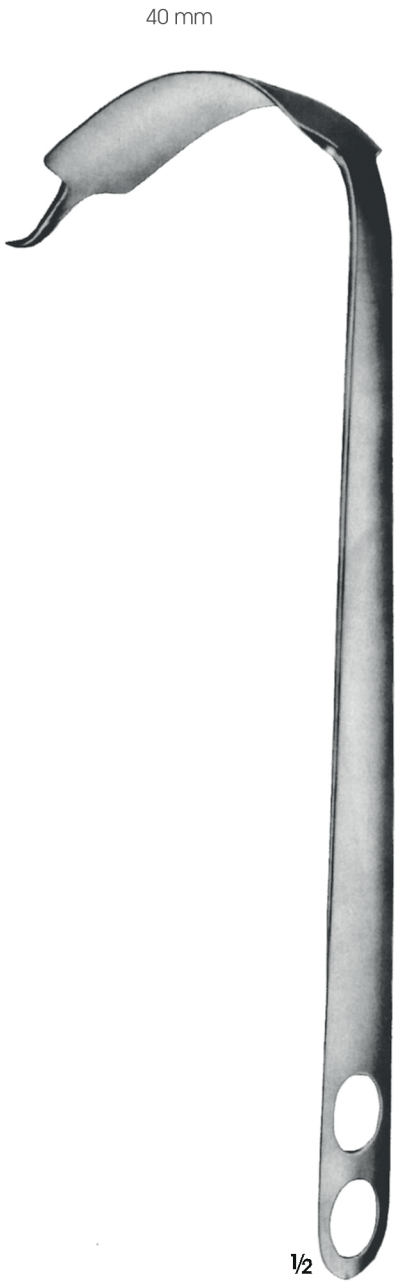

EM427-01
32 cm



EM429-02
32 cm



EM434-01
Femur ekartörü
Femoral retractor
38 cm

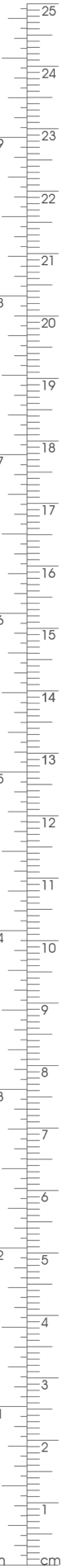
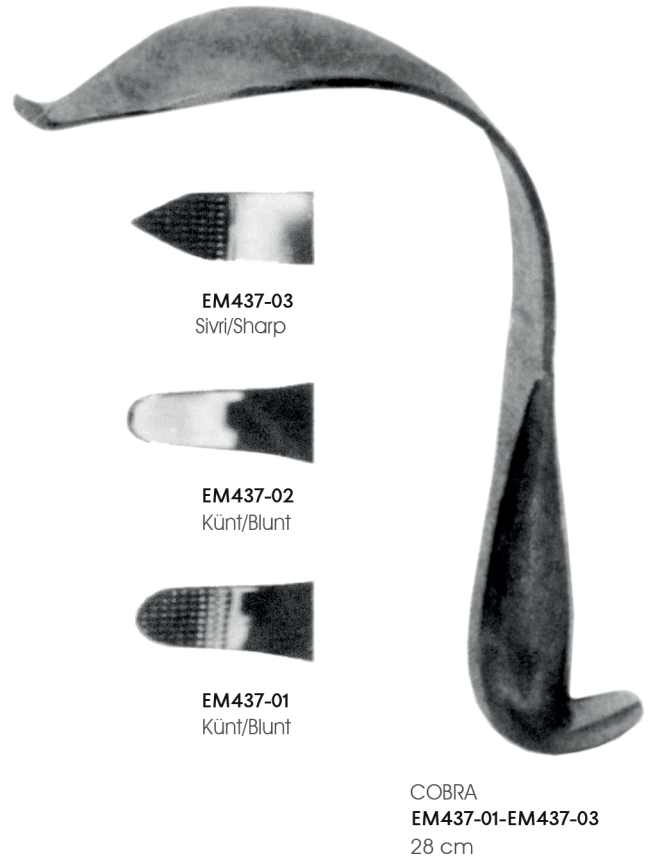

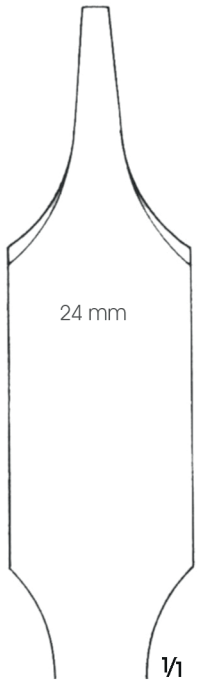

HOHMANN-ALDINGER
EM425-02
27 cm

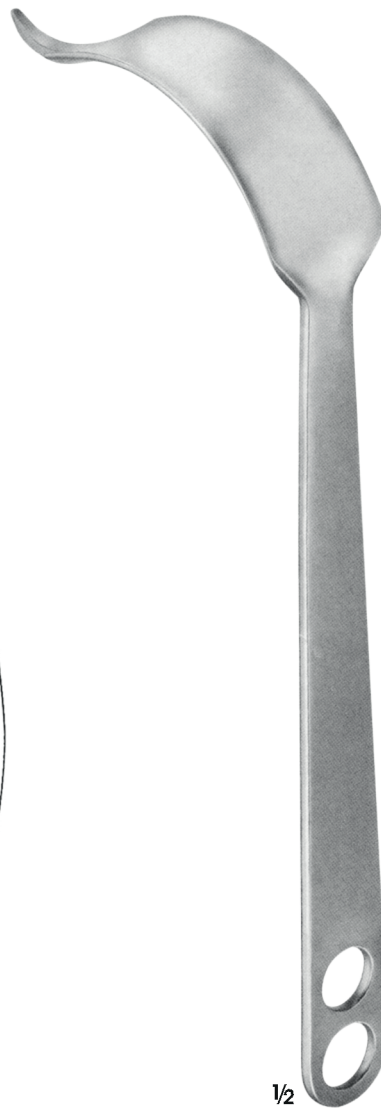

HOHMANN-ALDINGER
EM428-02
29 cm

12 mm

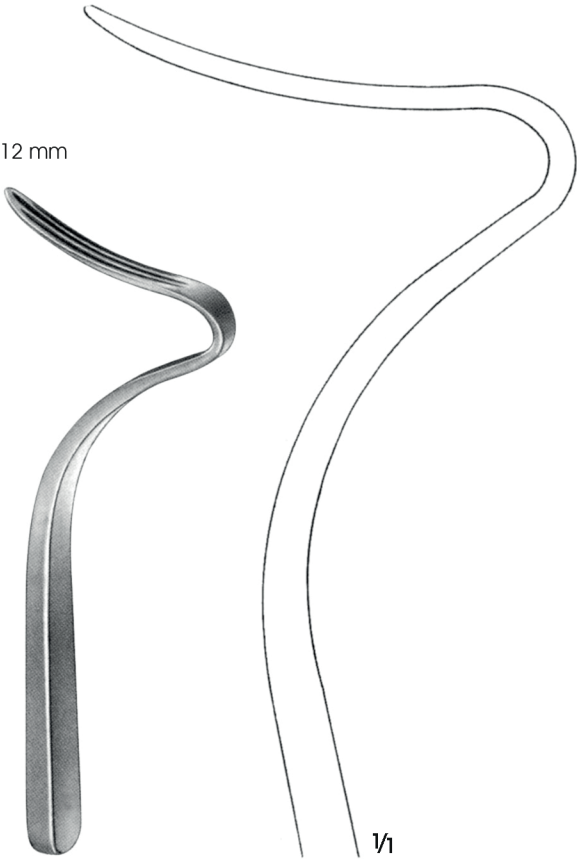

TAGER
EM440-00
Mafsas elevatör
Bone lever for angle joint operations
17.5 cm

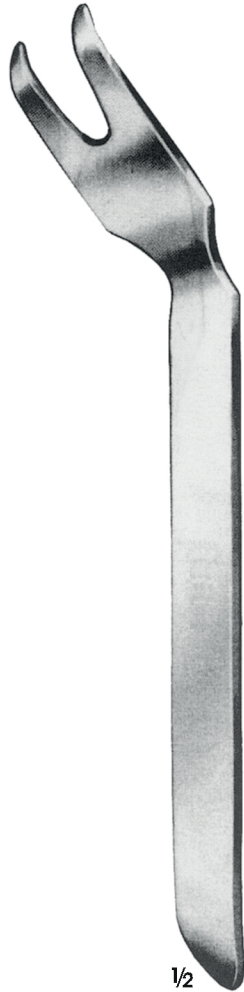

BLOUNT
EM431-02
27 cm

30 mm

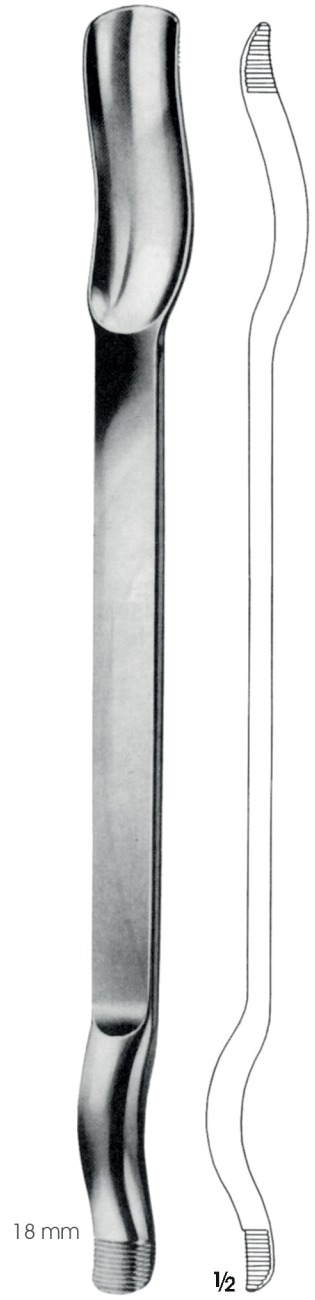

MURPHY-LANE
EM442-02
Lüksasyon elevatörü
Luxation lever
33 cm



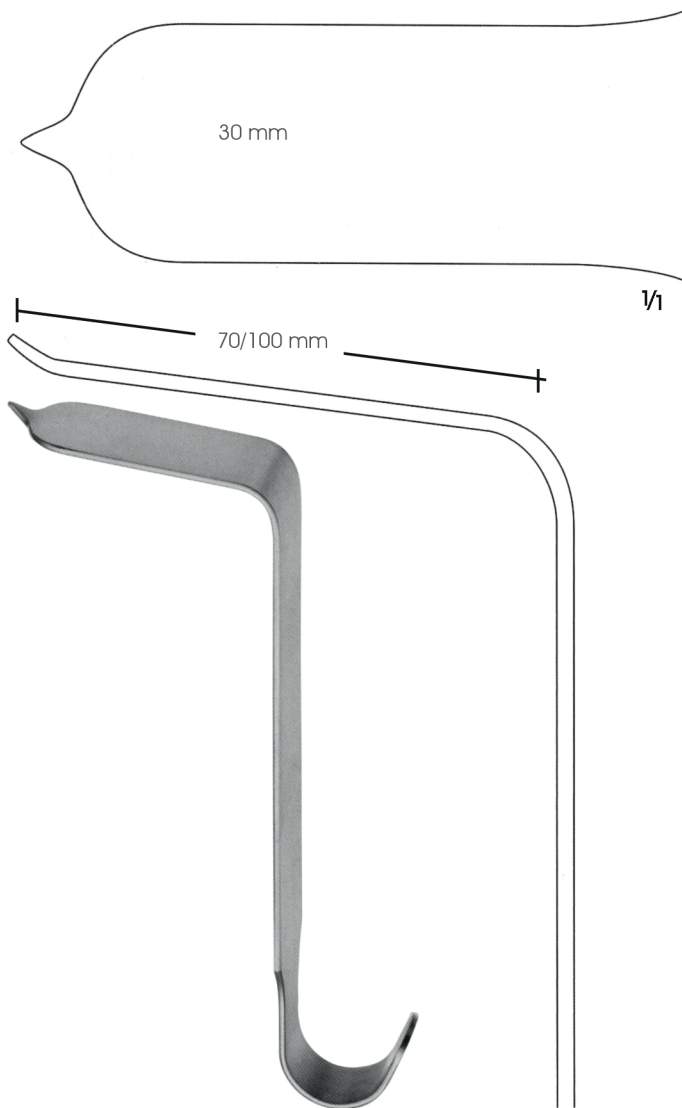

TAYLOR
EL482-00 30 x 70 mm
18.5 cm
EL482-01 30 x 100 mm
20 cm



HIBBS
EK335-00-EK335-02
23.5 cm

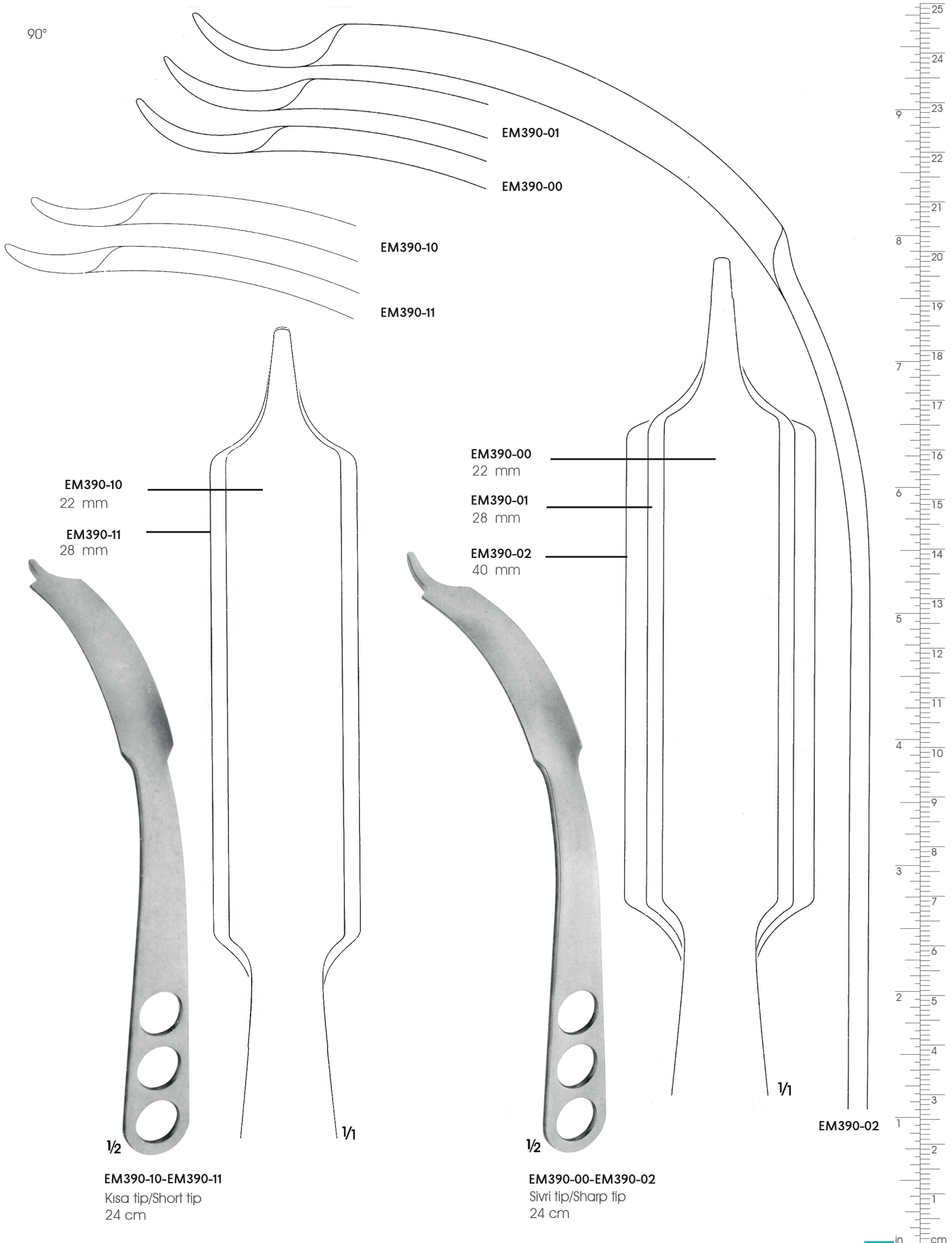

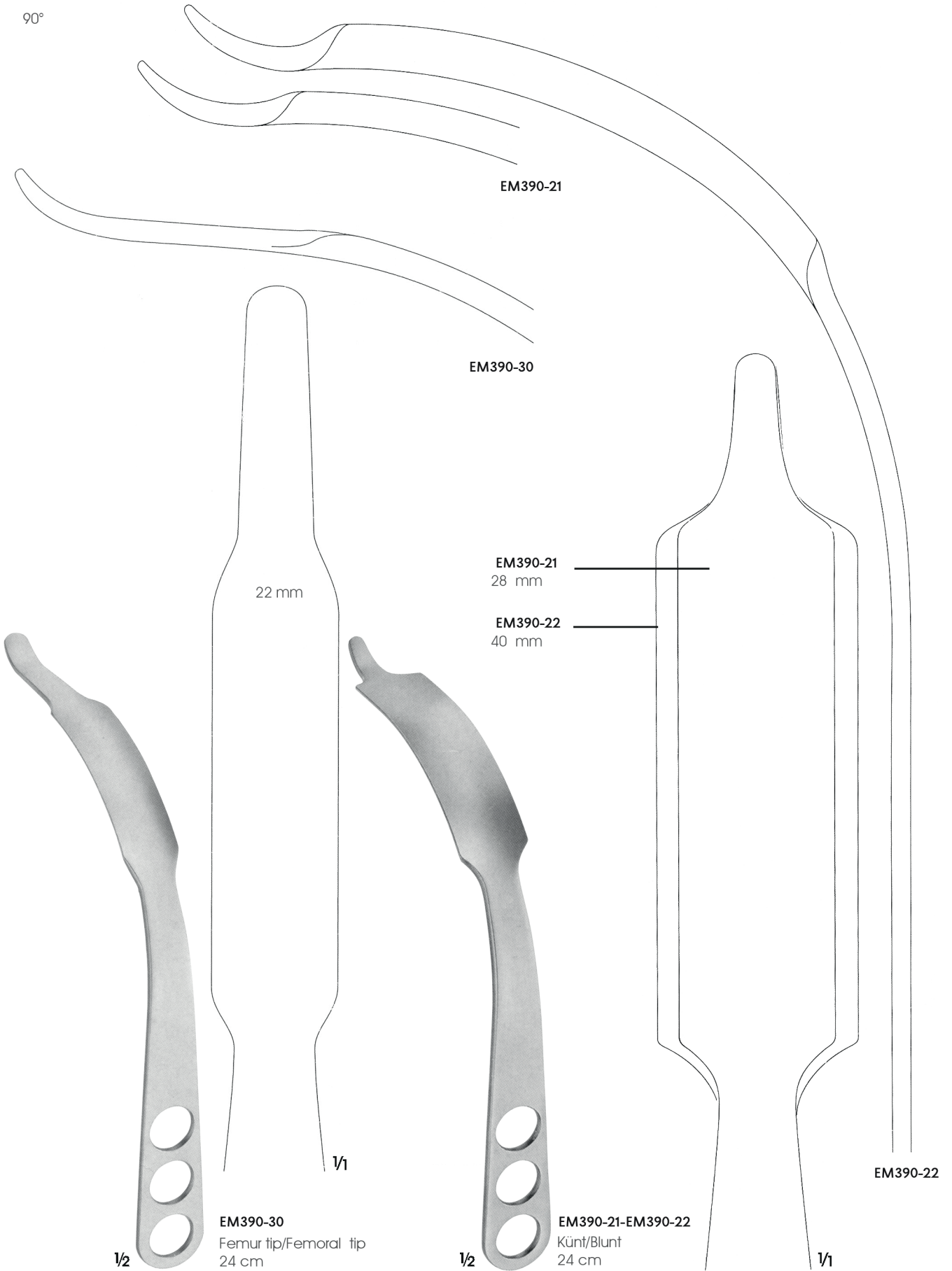

45°

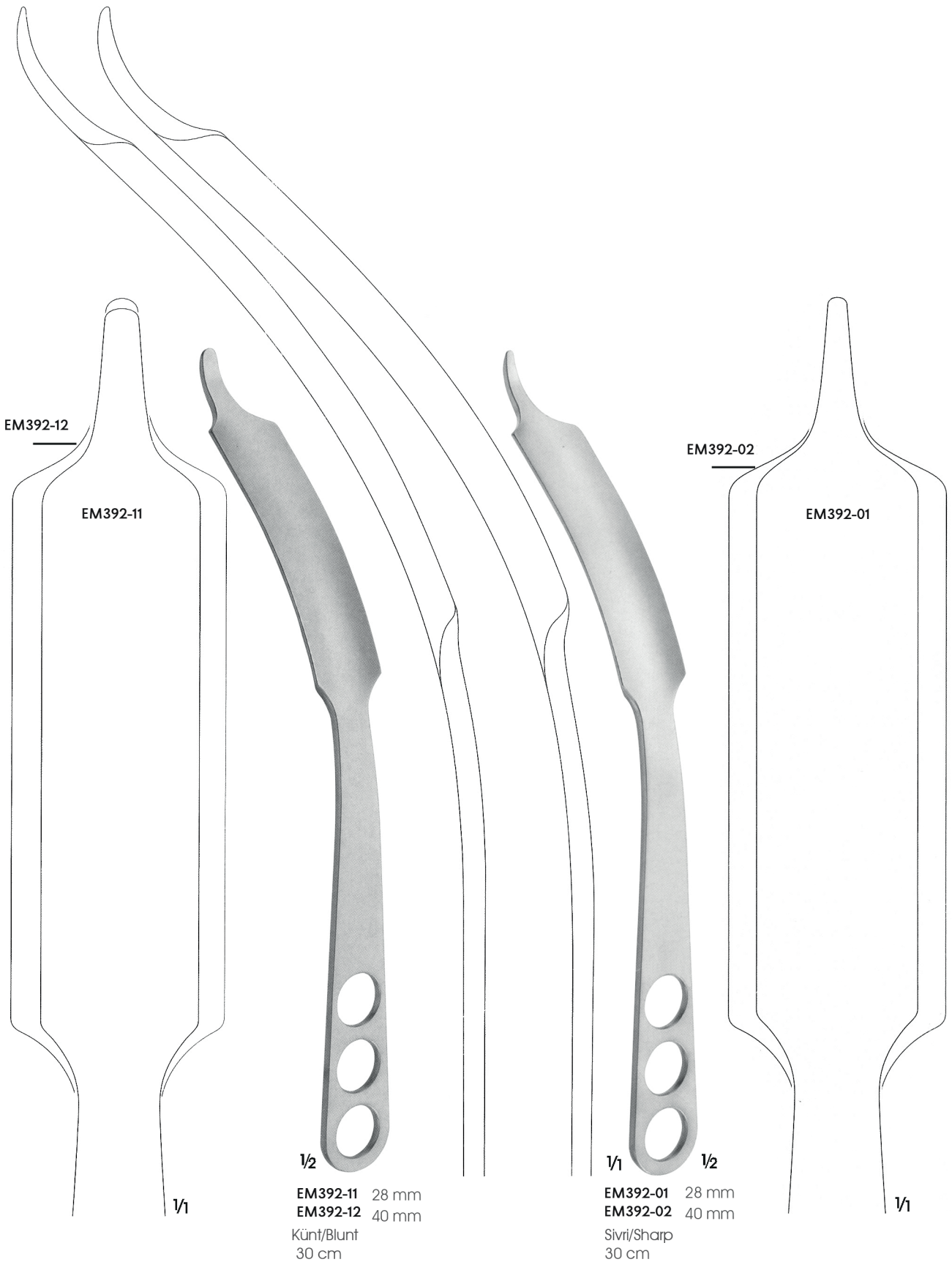

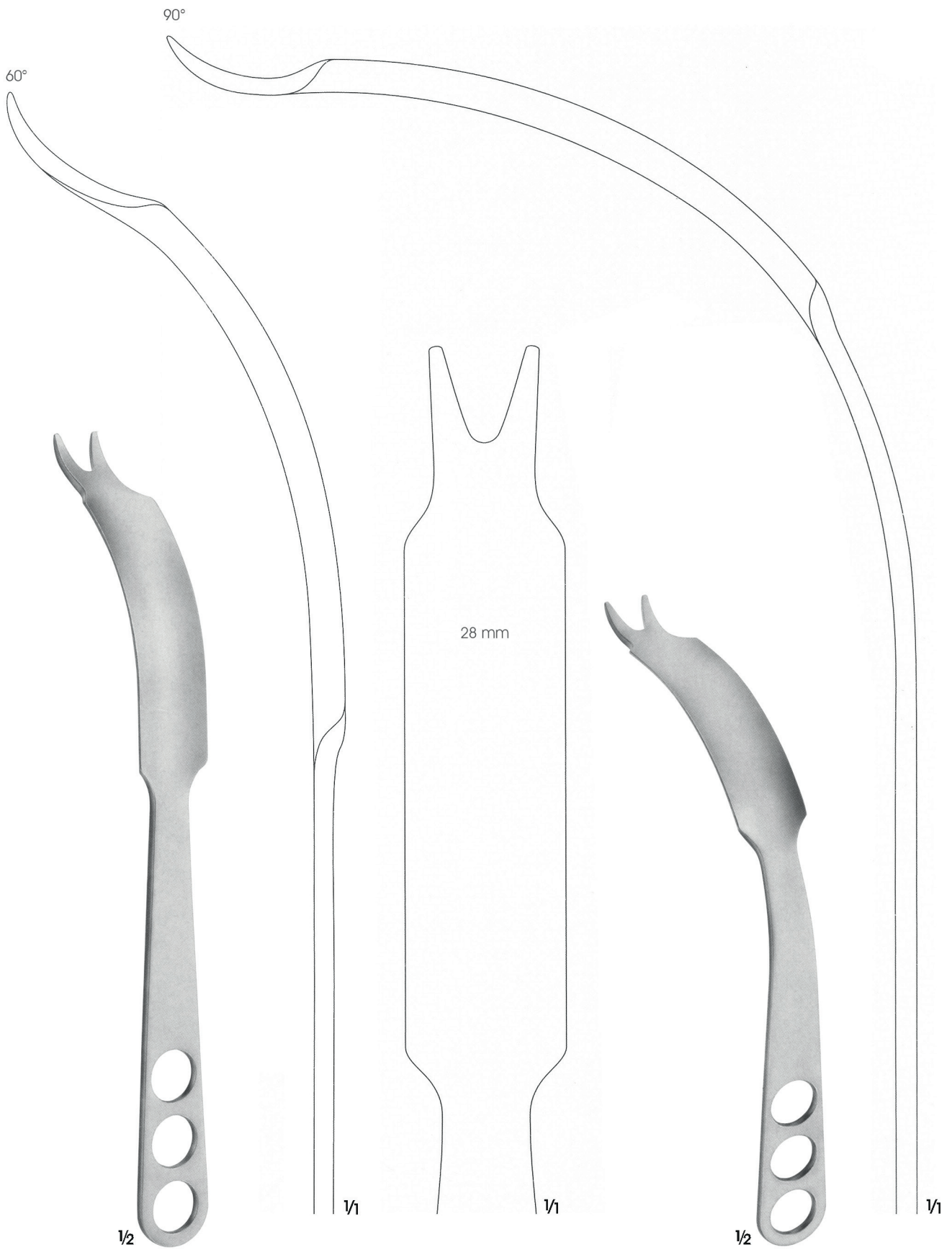

1/2

EM391-41
V-tip/V-tip
30 cm

1/1

28 mm

1/1

1/2

EM390-41
V-tip/V-tip
24 cm

1/1

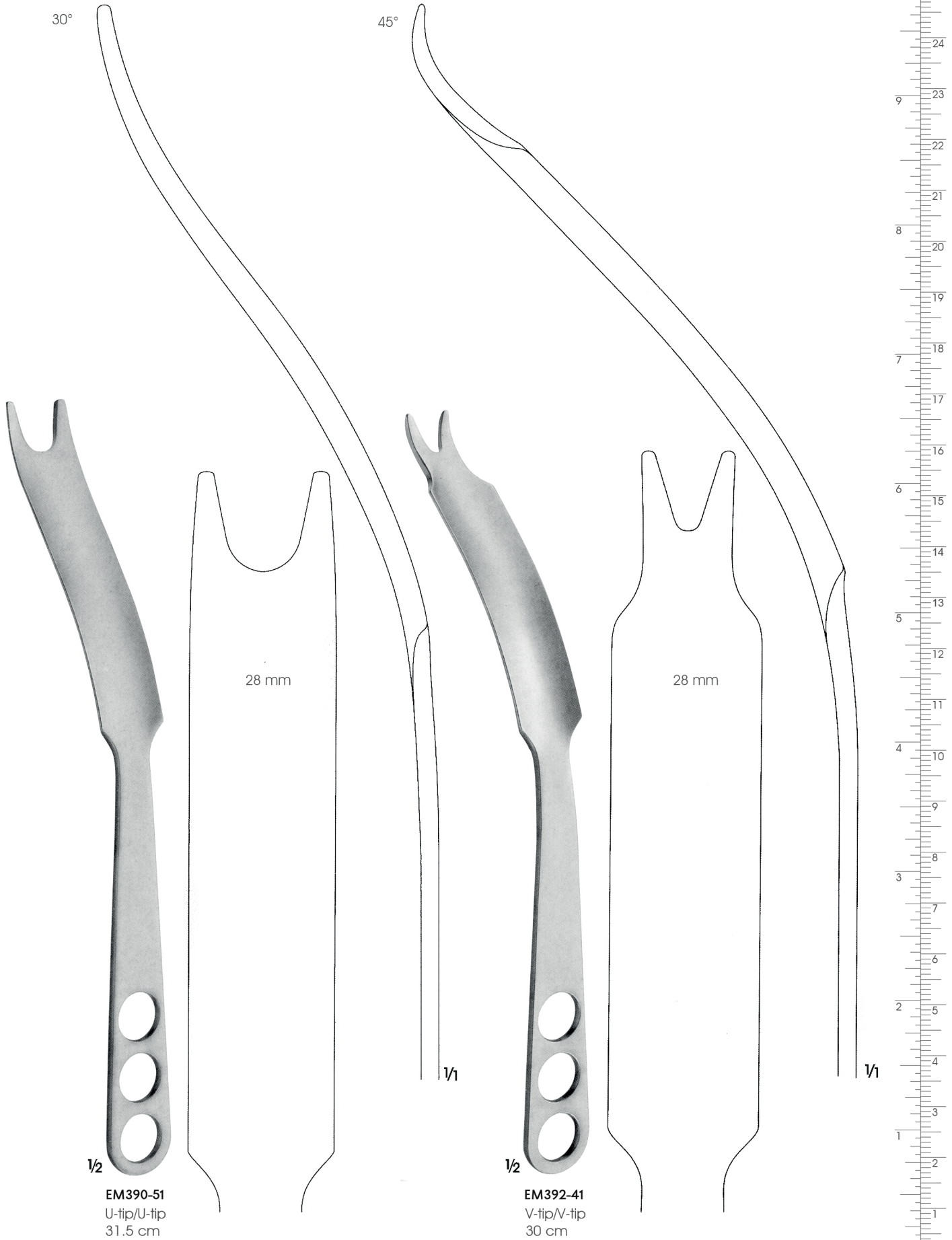

30°

45°

28 mm

28 mm

1/2

EM390-51
U-tip/U-tip
31.5 cm

1/1

1/2

EM392-41
V-tip/V-tip
30 cm

1/1

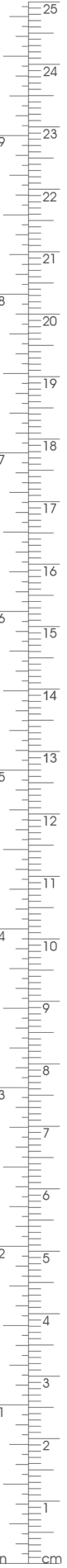

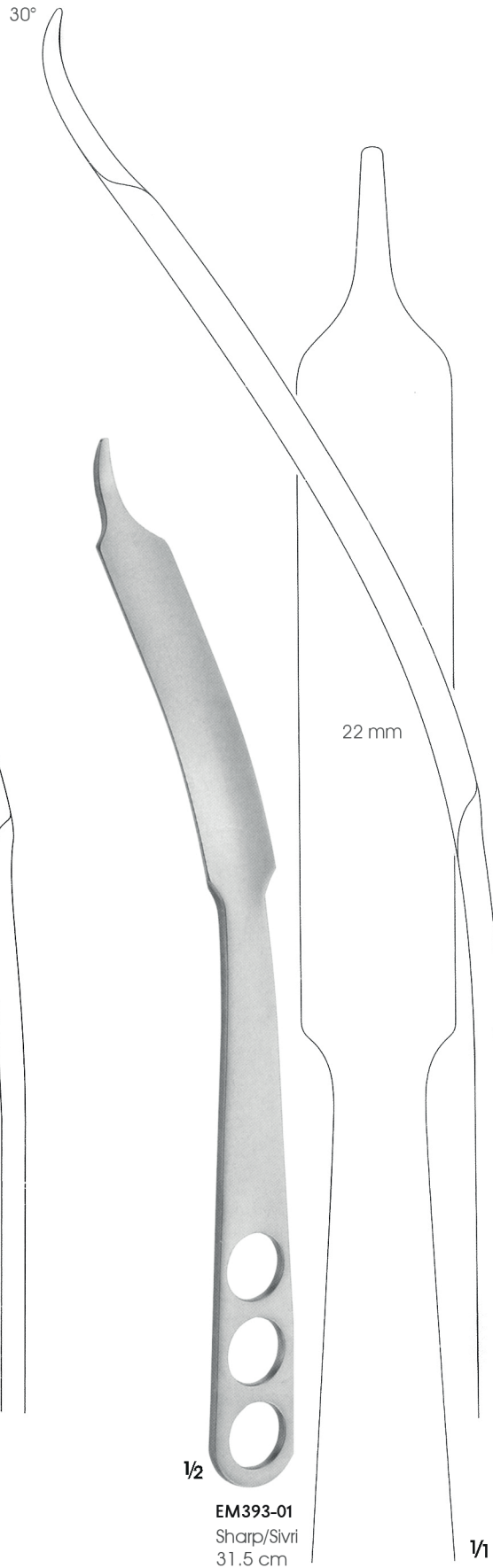
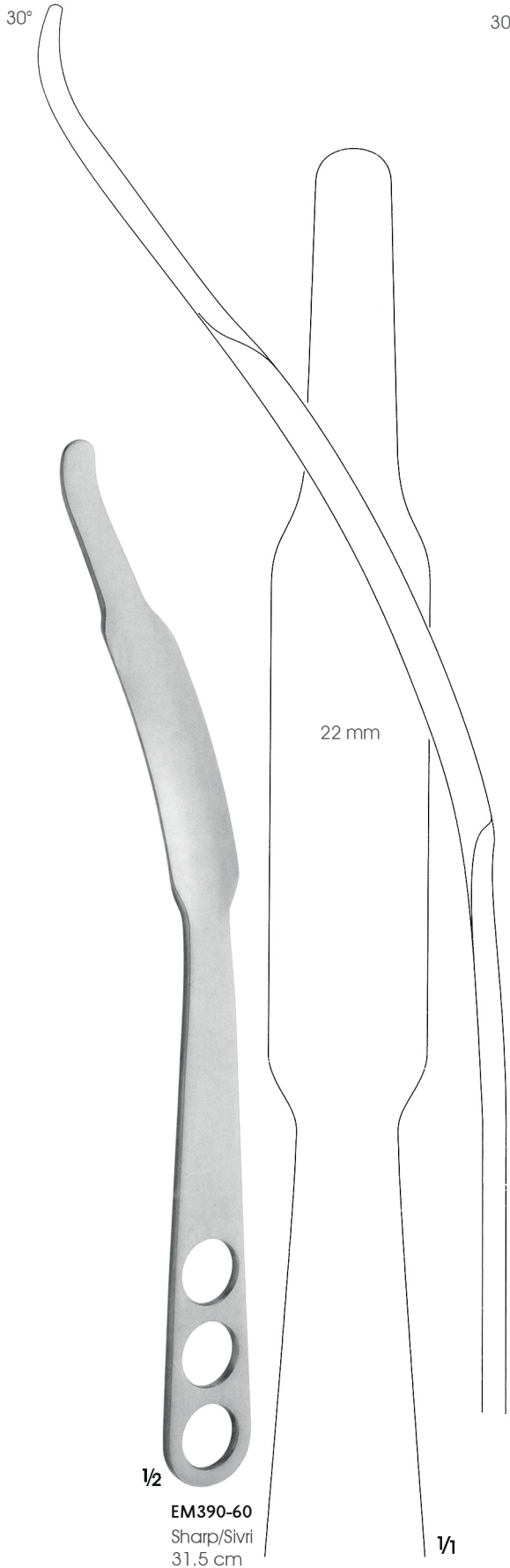

30°

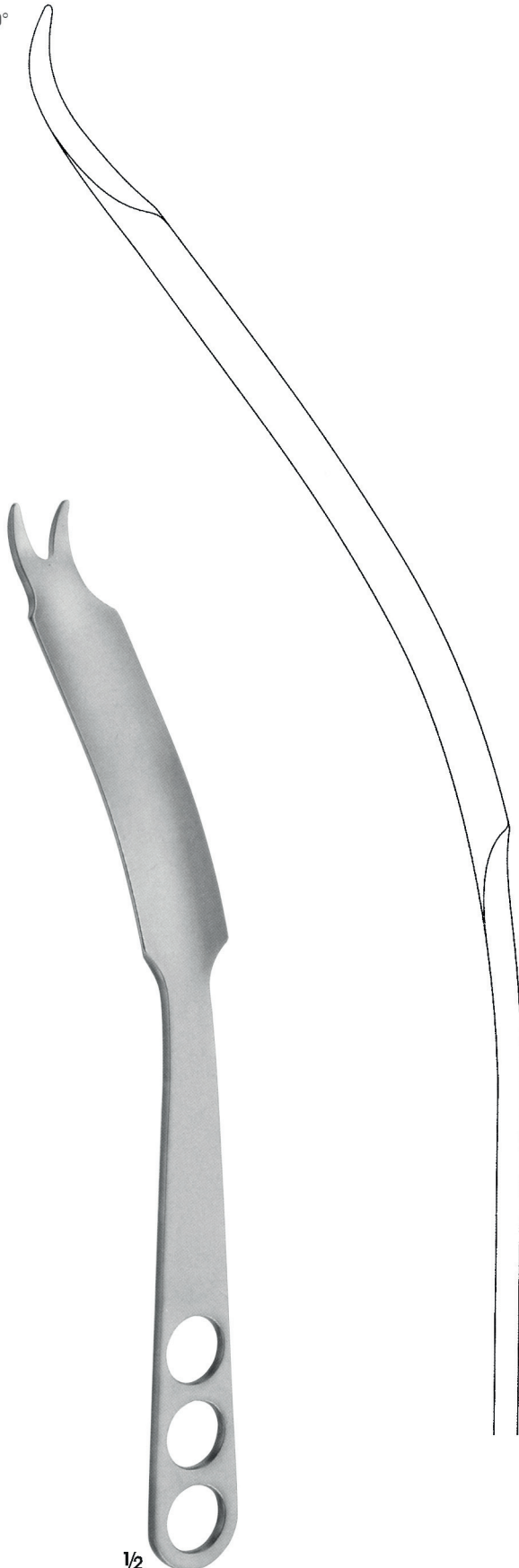

1/2

EM393-41
V-Tip/V-Tip
31.5 cm

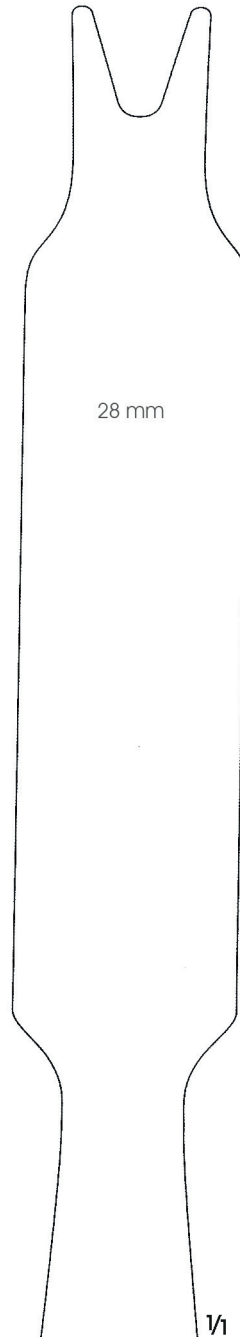

28 mm

1/1

EM399-01
Kavrama silikonu
Hand grip

EM399-02
Kavrama silikonu
Hand grip

EM399-03
Kavrama silikonu
Hand grip

EM399-04
Kavrama silikonu
Hand grip

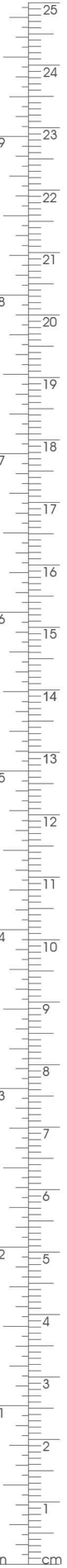

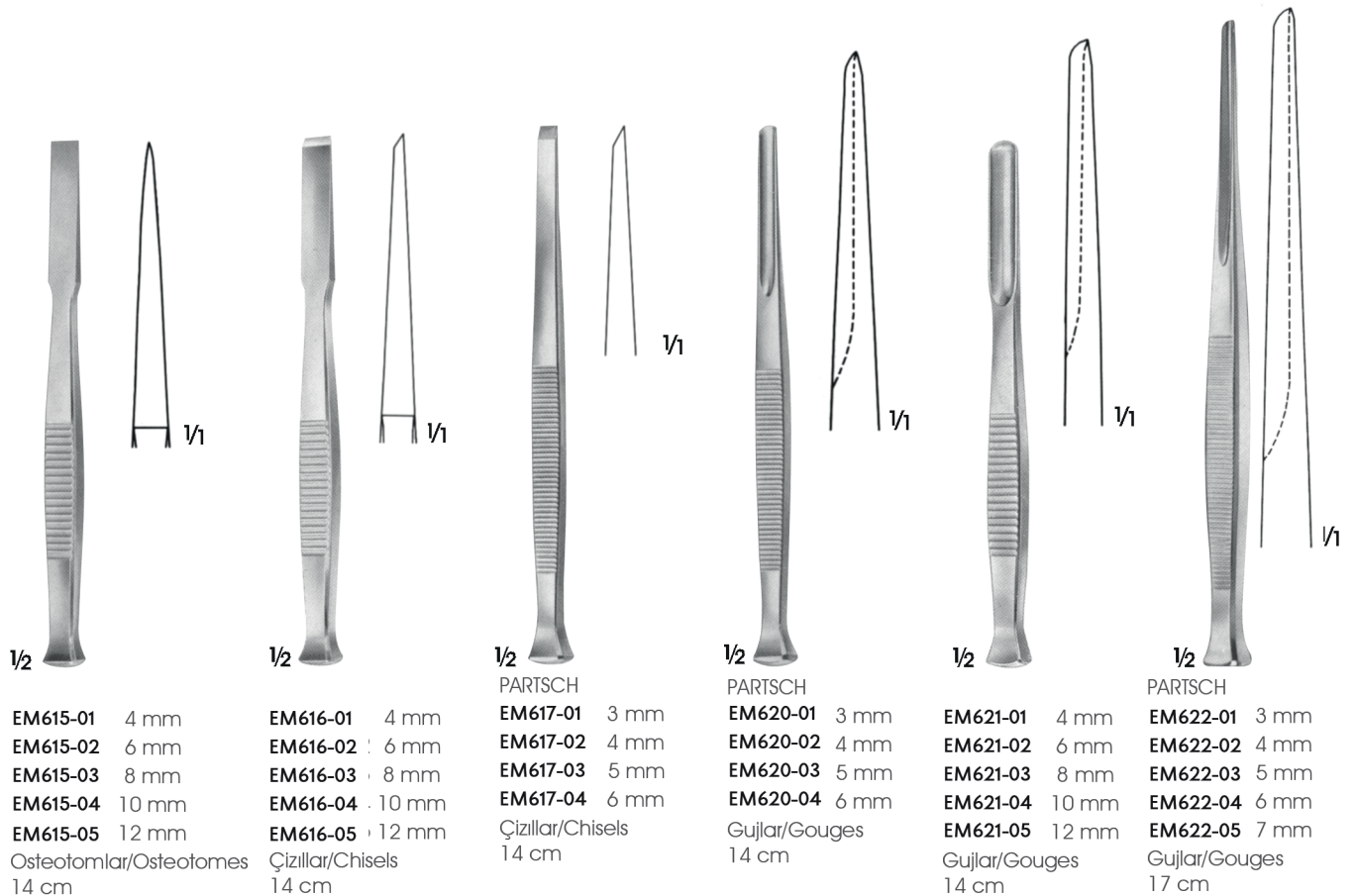
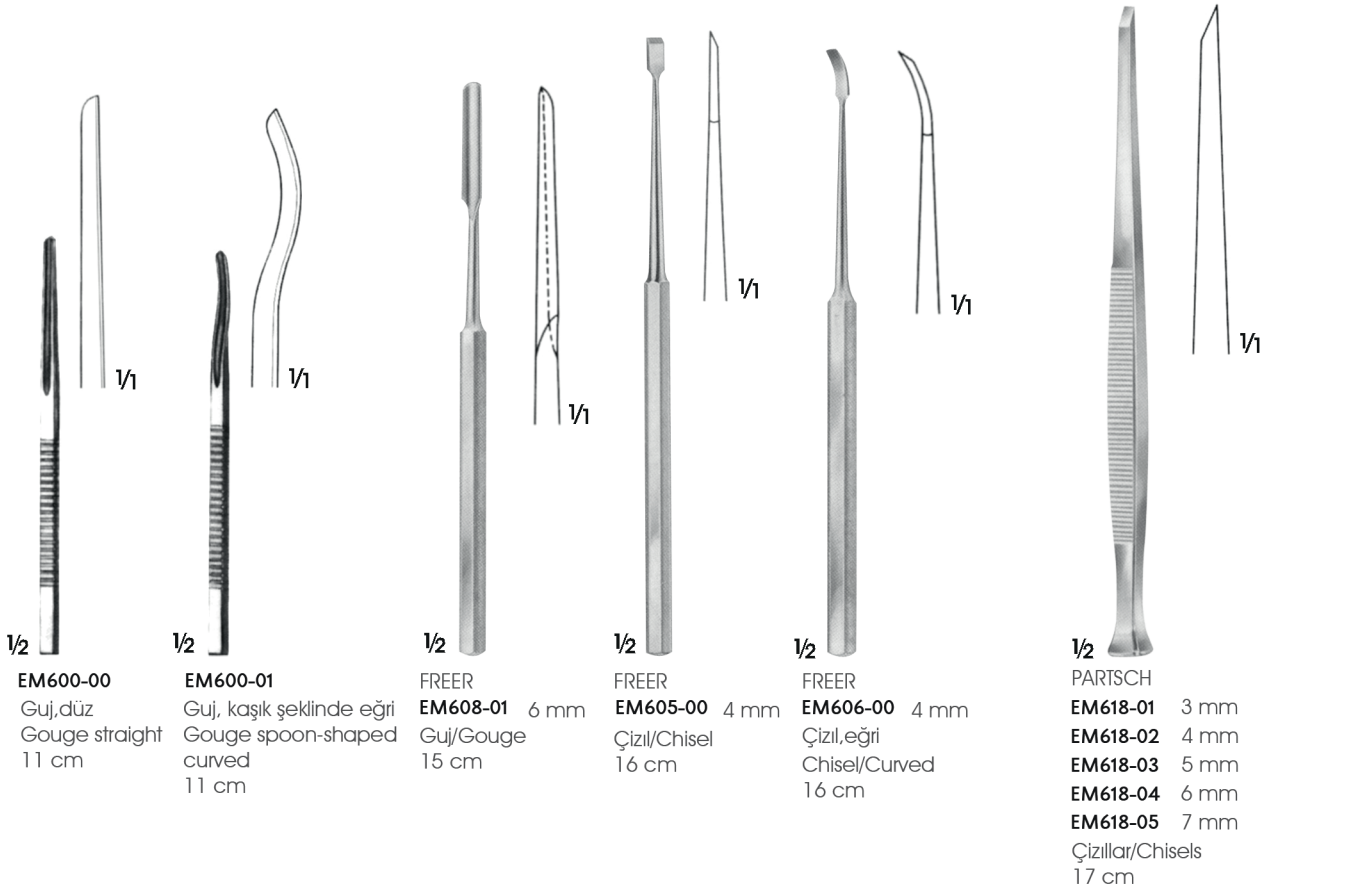



COTTLE
EM630-01 4 mm
EM630-02 6 mm
EM630-03 8 mm
EM630-04 10 mm
EM630-05 12 mm
 Derinlik göstergeli osteotomlar
 Osteotomes with depth
 markings
 18 cm



COTTLE
EM631-01 4 mm
EM631-02 7 mm
EM631-03 9 mm
EM631-04 12 mm
 Derinlik göstergeli
 Çizil-osteotomlar
 Chisel-osteotomes
 with depth markings
 18 cm



COTTLE
EM632-01 6mm
 Çizil-osteotom
 Chisel-osteotomes
 18 cm



COTTLE
EM633-01 8 mm
 Derinlik göstergeli çizil
 Chisel with depth
 markings
 18 cm



COTTLE
EM634-10 2 mm
EM634-11 4 mm
EM634-12 6 mm
EM634-13 7 mm
EM634-14 9 mm
EM634-16 12 mm
 Osteotom/Osteotomes
 18 cm



WALTER
EM643-00 2 mm
EM643-01 3 mm
EM643-02 4 mm
EM643-04 7 mm
EM643-05 9 mm
 Osteotom/Osteotomes
 19 cm



ALEXANDER
EM625-01 5 mm
EM625-02 7 mm
EM625-03 9 mm
EM625-04 11 mm
 Gujlar/Gouges
 17 cm



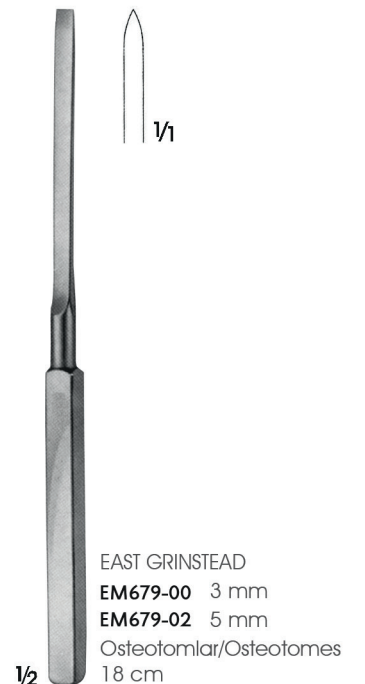
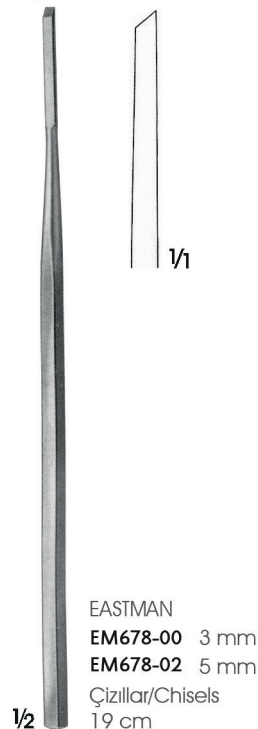
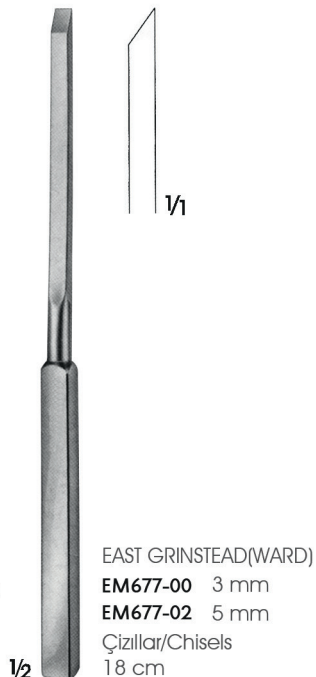
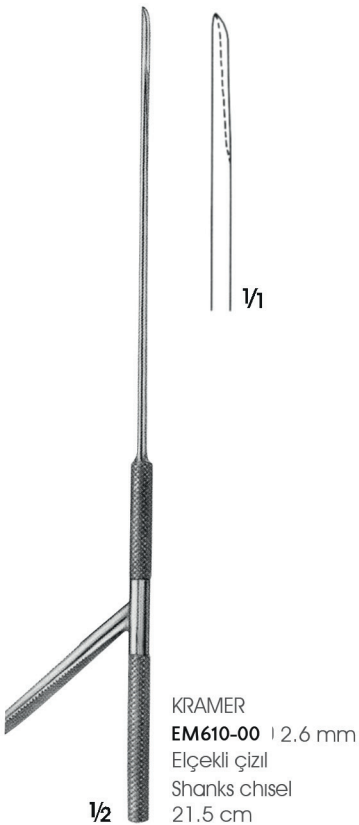
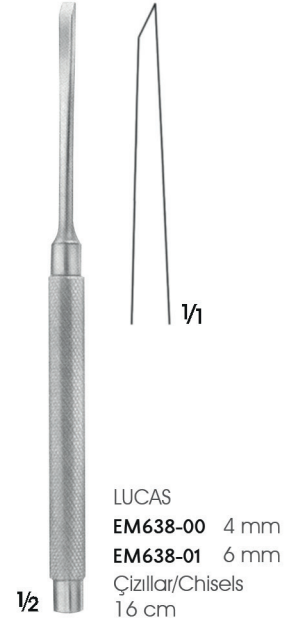
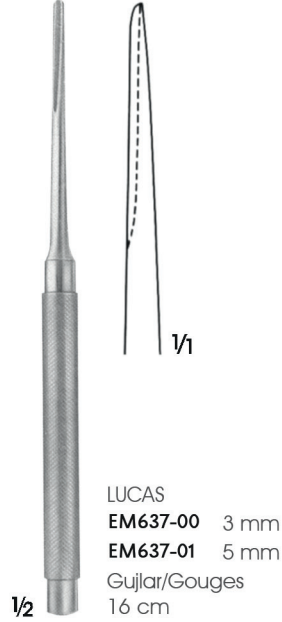
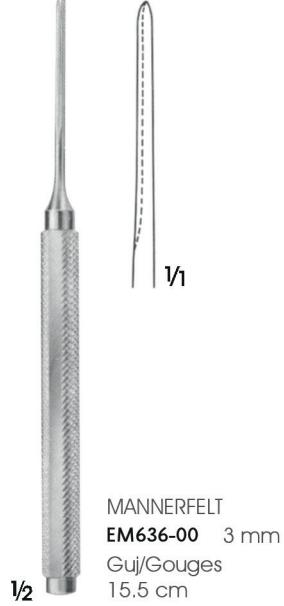
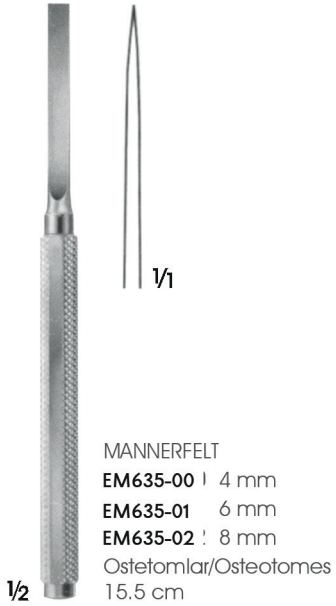

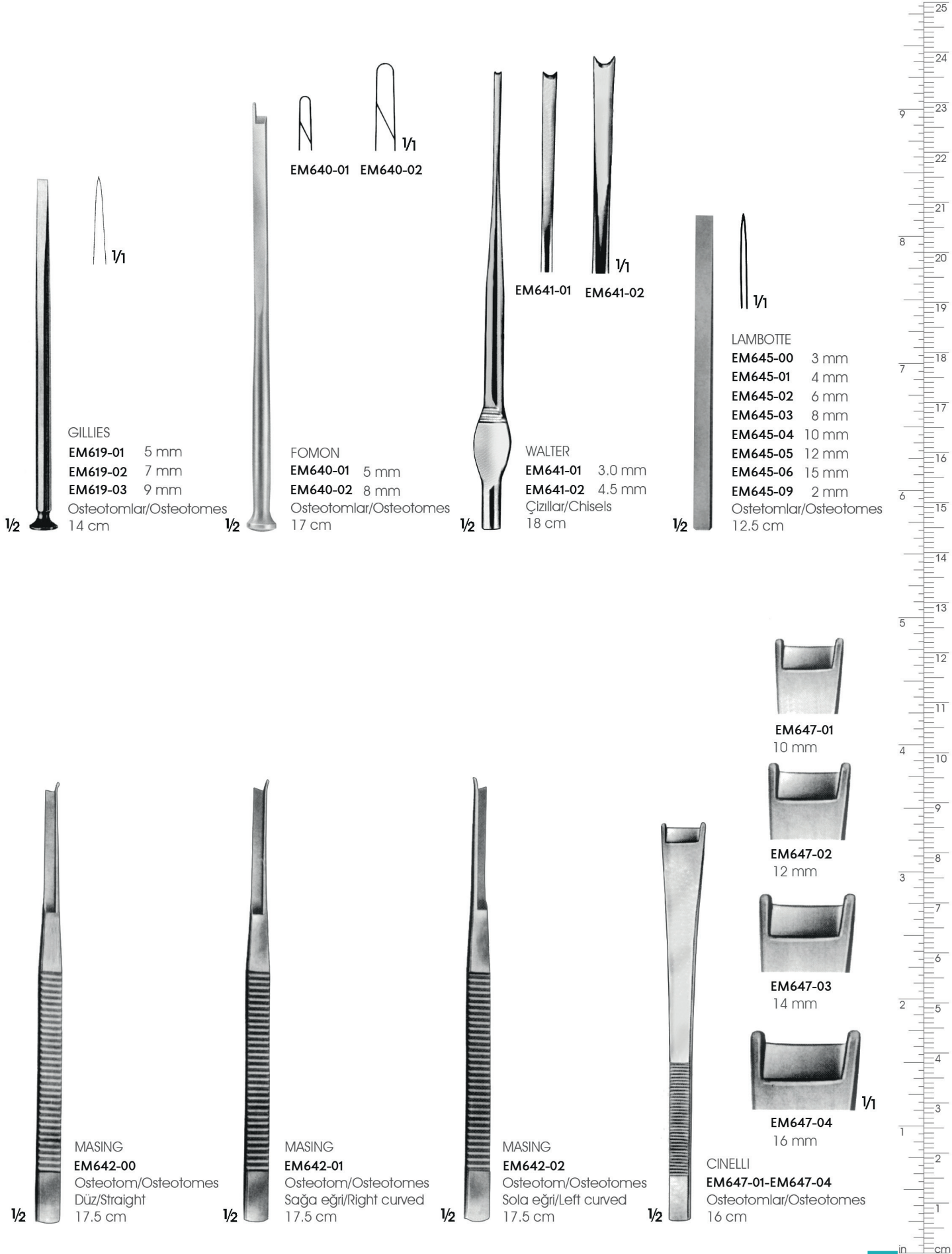

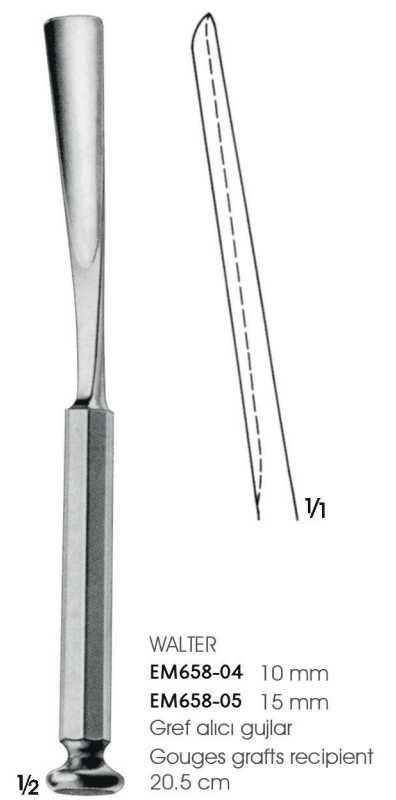
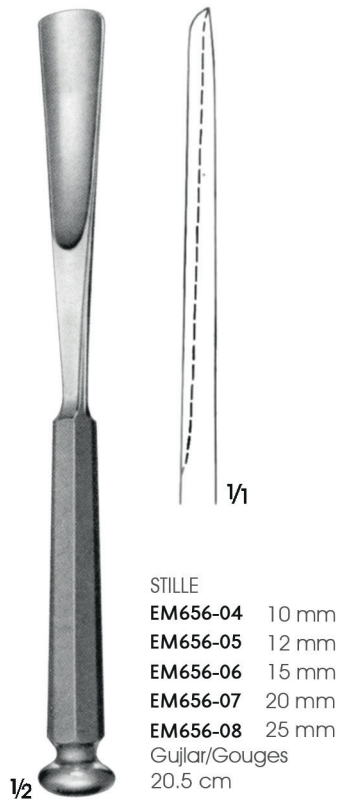
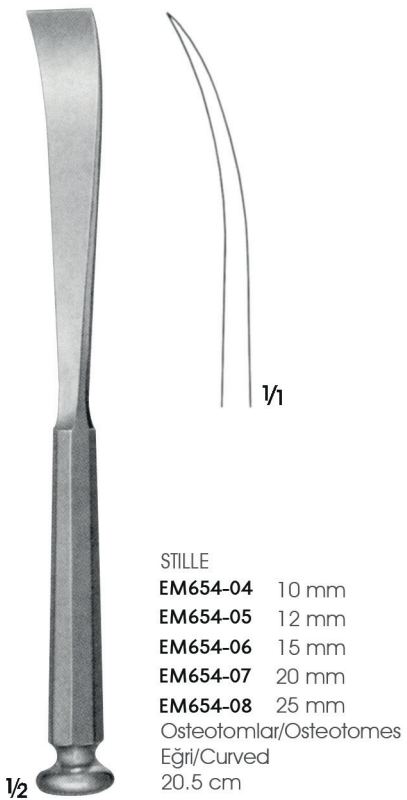
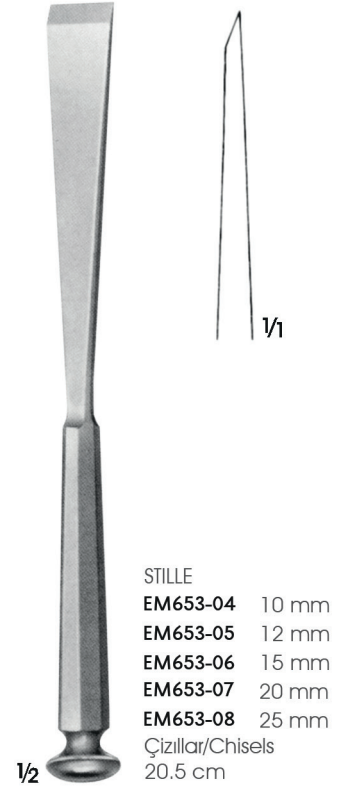
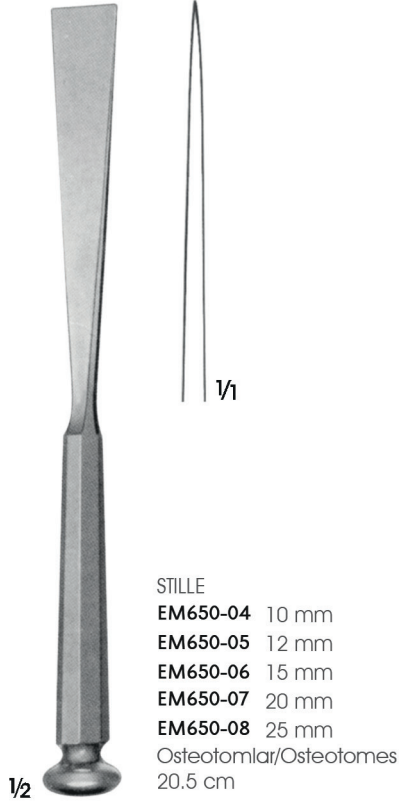

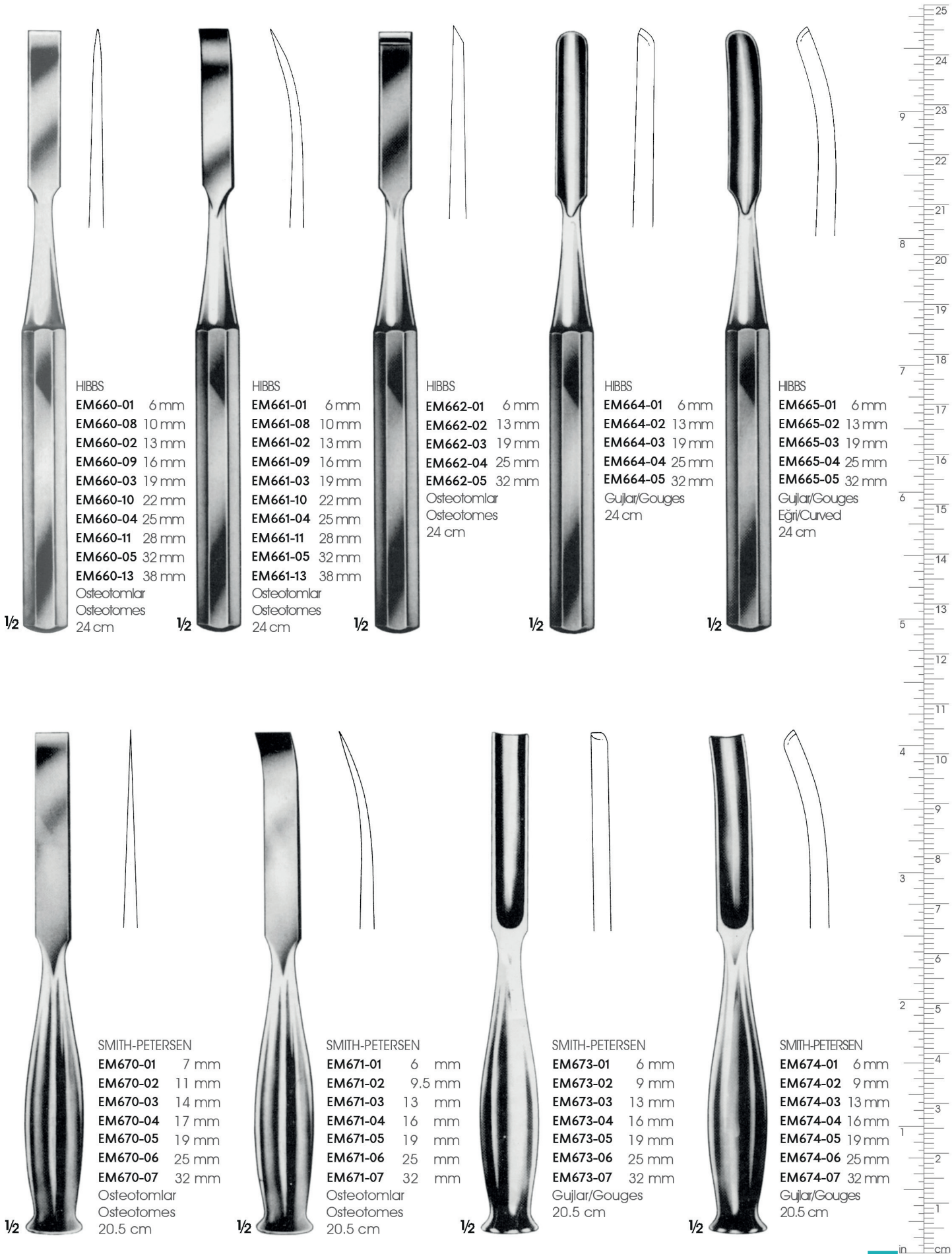

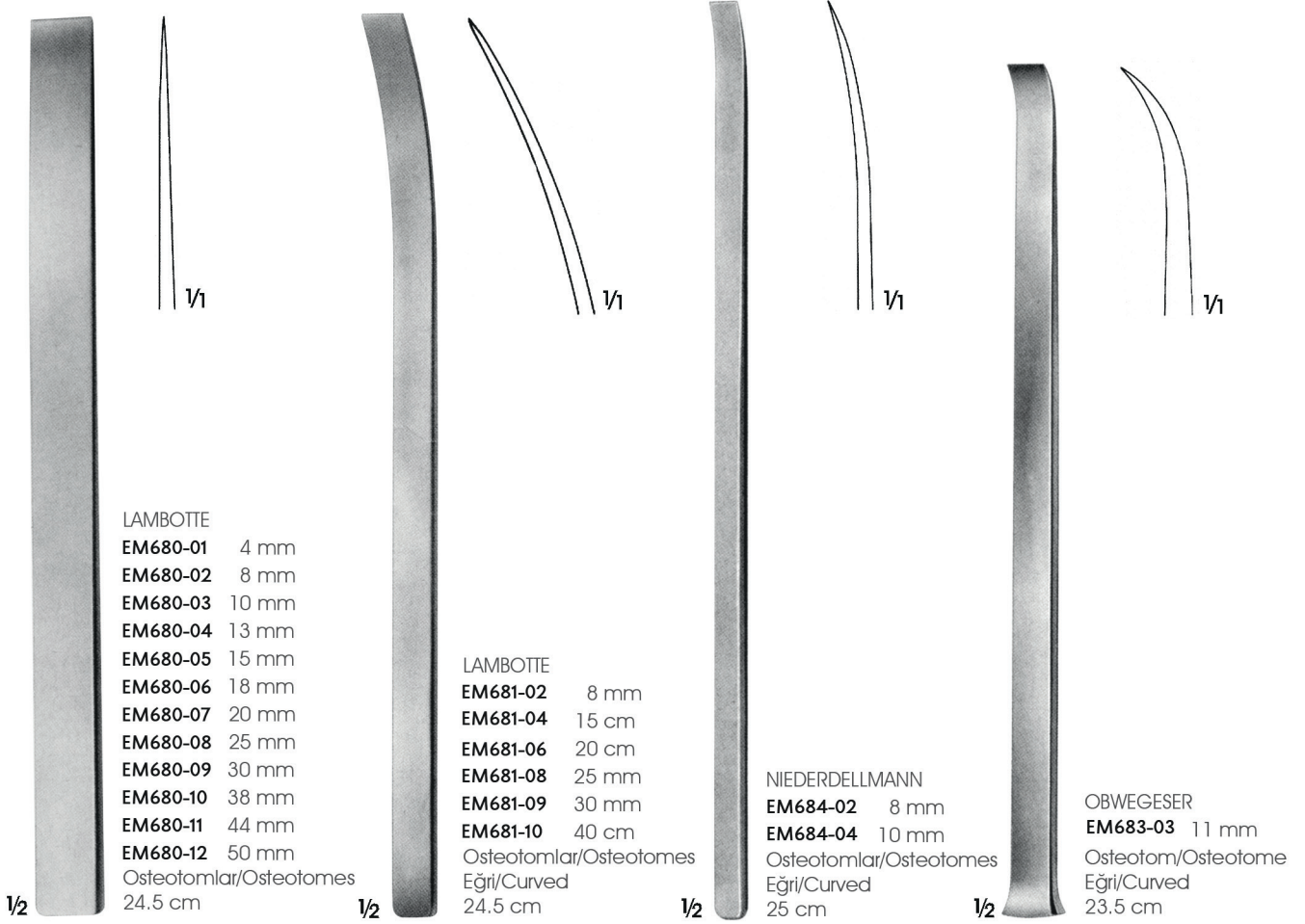

143° buhar sterilizatörlerinde steril edilebilir.
Can be sterilized in a steam sterilizer up to 143°



EV606-05
Anahtar/Key

25 mm



EM700-07



EM700-08



EM700-09

EM700-00P

Değiştirilebilir bıçaklı,
çizil
(V 606.05 ile)
Changeable blades,
chisel
(V 606.05 with key)



EM700-01 5 mm
EM700-02 10 mm
EM700-03 16 mm
EM700-04 25 mm
Boy/lenght 45 mm

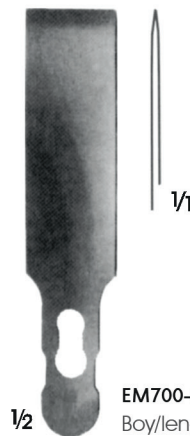

EM700-05 25 mm
Boy/lenght 78 mm

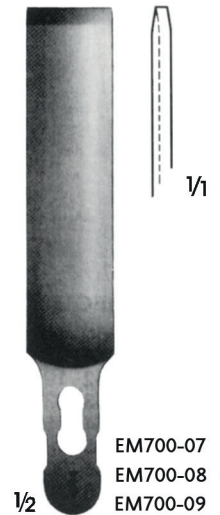

EM700-07 50 mm
EM700-08 60 mm
EM700-09 70 mm

143° buhar sterilizatörlerinde steril edilebilir.
Can be sterilized in a steam sterilizer up to 143°

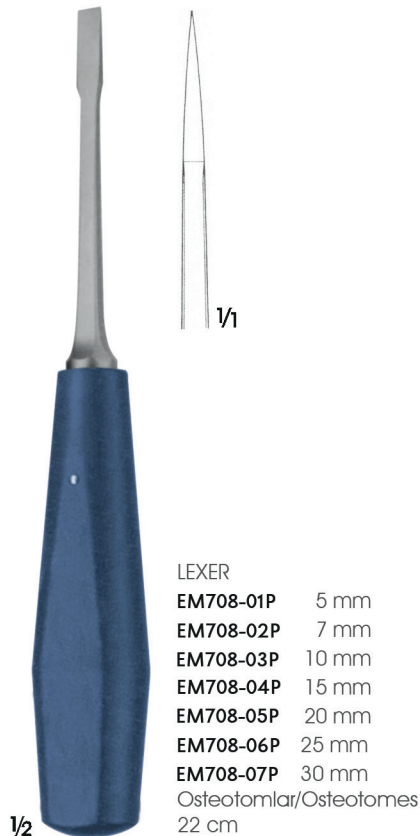
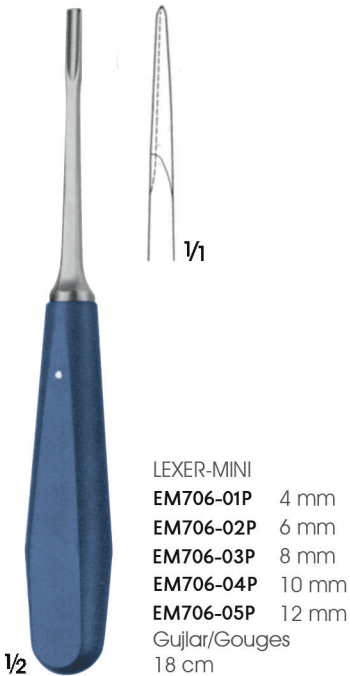
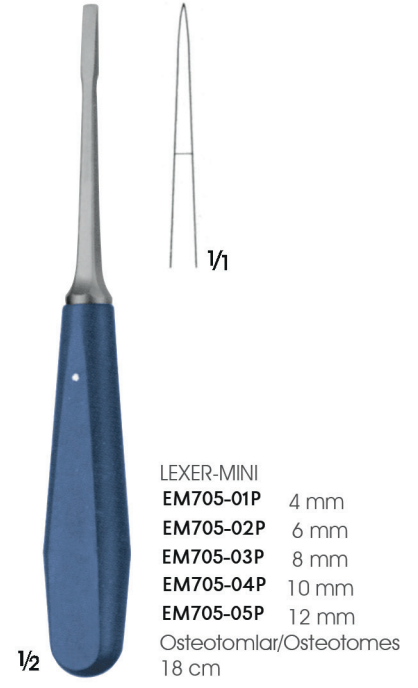
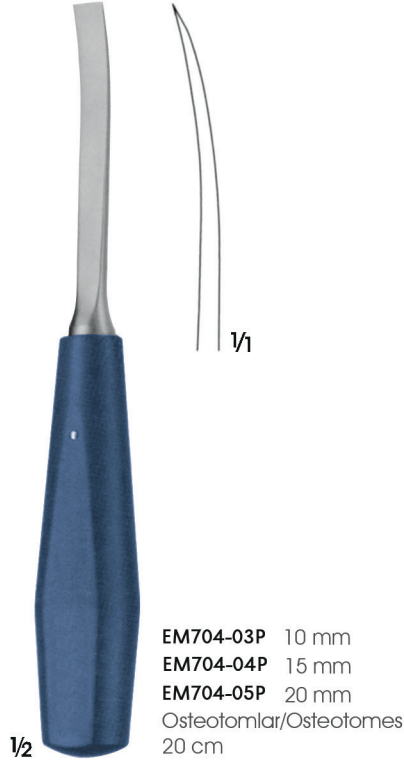
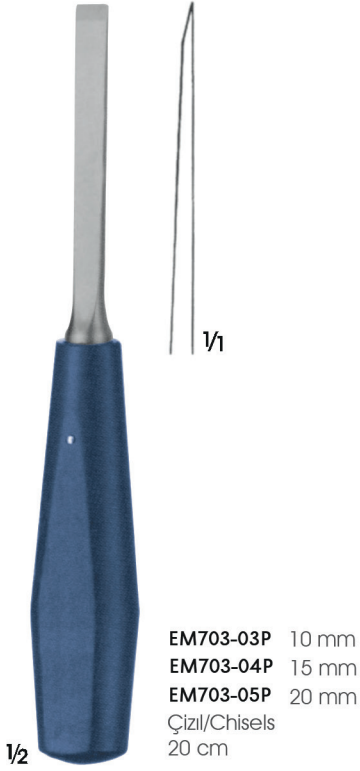

143° buhar sterilizatörlerinde steril edilebilir.
Can be sterilized in a steam sterilizer up to 143°



EM711-03P 9 mm
Kırık vida çıkartıcı guj
Broken screw extractor
gouges
22 cm

ZIELKE
EM713-01P 5.5 mm
EM713-03P 9.0 mm
Skolyoz operasyonu için gujlar
Gouges for scoliosis operations
23 cm

EM716-01P 5 mm
EM716-02P 10 mm
EM716-03P 15 mm
Sponjiyoz gujlar, eğri
Spongiosa gouges, curved
25 cm

LEXER
EM725-02P
Sponjiyoz guj
Spongiosa gouges
28 cm

143° buhar sterilizatörlerinde steril edilebilir.
Can be sterilized in a steam sterilizer up to 143°



EM720-05P 20 mm
Çizil/Chisels
24.5 cm



EM721-04P 16 mm
Çizil, eğri
Chisel, curved
26.5 cm

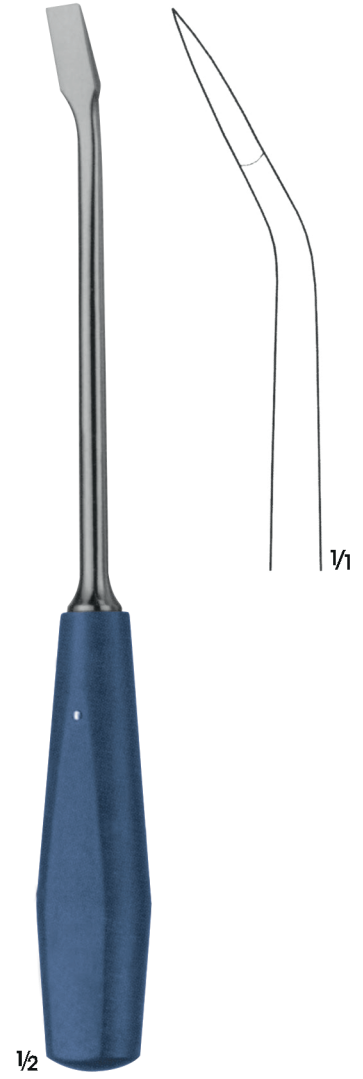

LEXER
EM723-04P 10 mm
EM723-05P 15 mm
Osteotomlar, açılı
Osteotomes angled
27.5 cm



143° buhar sterilizatörlerinde steril edilebilir.
Can be sterilized in a steam sterilizer up to 143°

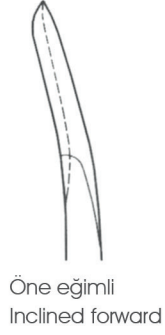
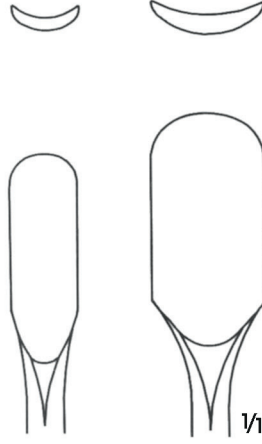

EM727-01P
9 mm

EM727-02P
15 mm

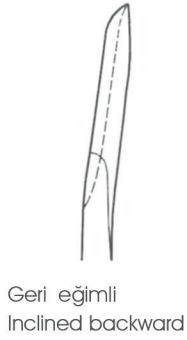

EM728-01P
9 mm

EM728-02P
15 mm

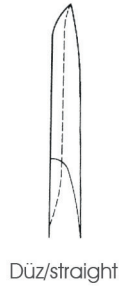

EM729-01P
9 mm

EM729-02P
15 mm

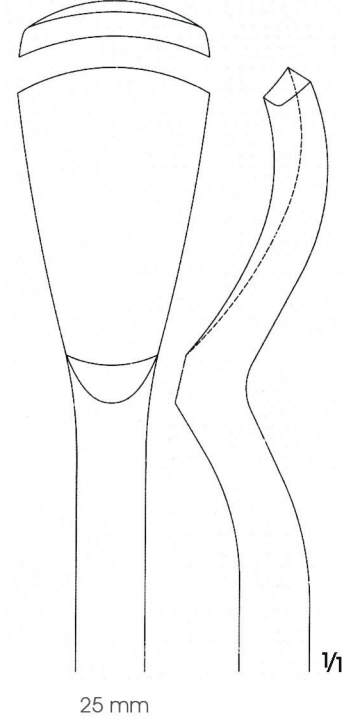

WAGNER
EM727-01P-EM727-02P
EM728-01P-EM728-02P
EM729-01P-EM729-02P
34 cm



EM737-01P P
29 cm



EM714-01P 6 mm
EM714-02P 8 mm
EM714-03P 11 mm
EM714-04P 16 mm
Tabaka gujlar, çevrimli
Lamina gouge, cranked
23.5 cm

1/2



EM735-01P
27 cm

1/2



EM735-02P
27 cm

1/2



EM736-01P
25 cm

1/2

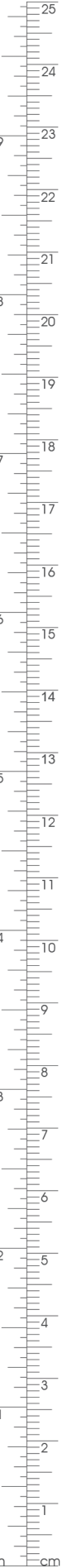

8 mm



1/2

COBB
EM740-02
28 cm

8 mm



1/2

COBB
EM741-02
28 cm

8 mm



1/2

COBB
EM742-02
28 cm

8 mm



1/2

COBB
EM743-02
28 cm

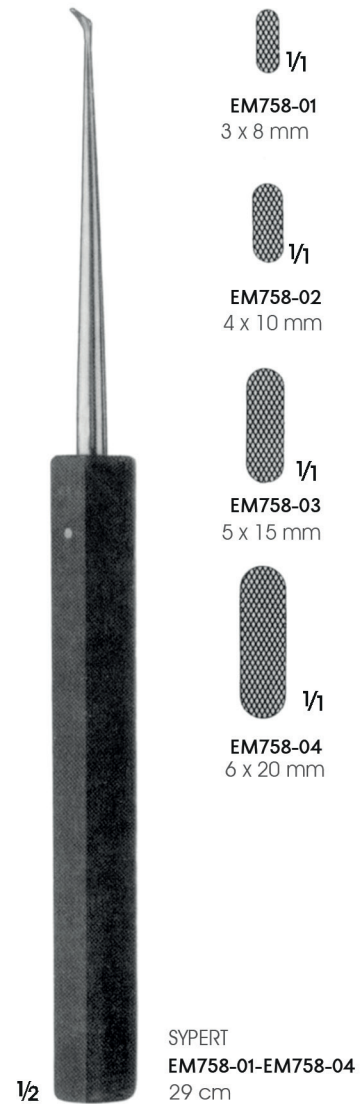
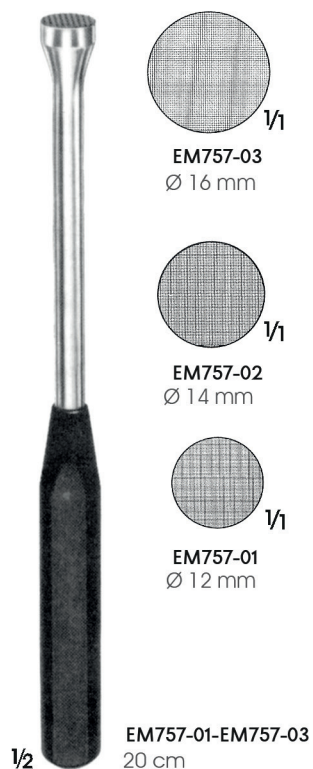
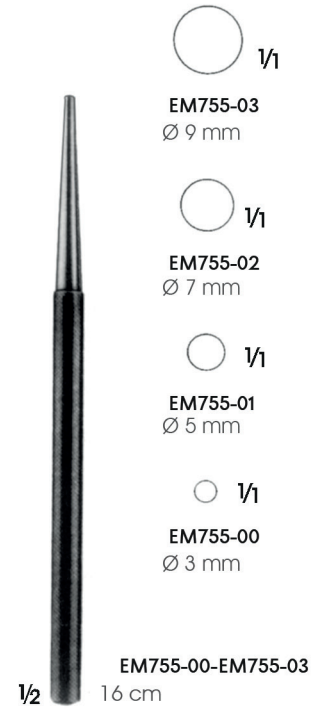
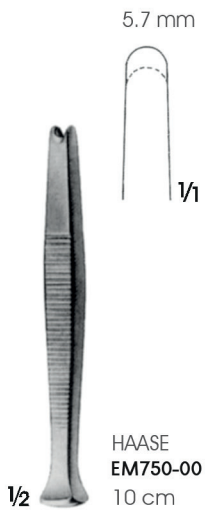

Çekiçin başlıklarına göre ağırlıkları değişebilir
Weights refer to heads of the mallets



Çekiğin başlıklarına göre ağırlıkları değişebilir
Weights refer to heads of the mallets



Ø 20 mm

MEAD
EM800-01 180 gr
Plastik diskli/Plastic disc
19 cm
EM800-05
Yedek disk bir çift
Pair of spare disc

1/2



Ø 25 mm

EM801-00 135 gr
Plastik diskli/Plastic disc
18.5 cm
EM801-05
Yedek disk bir çift
Pair of spare disc

1/2



Ø 30 mm

EM802-02
Yedek disk bir çift
Pair of Spare discs

EM802-01 200 gr
Plastik diskli/Plastic disc
24.5 cm

1/2



Ø 35 mm

Diskler olmadan çekiç kafa 125 gr
Mallet head without disks 125 gr

WAGNER
EM803-00 Komple/Complete
Metal disk M 803.02/Metal disc M 803.02
Plastik disk M 803.03/Plastic disc M 803.03
Anahtar M 803.10/Wrench M 803.10
23.5 cm

1/2

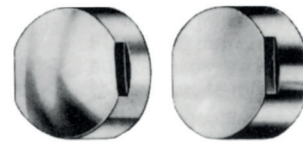

EM803-01 215 gr.
1 Metal disk, düz
1 Metal disc, flat
1 Metal disk, konvex
1 Metal disc, convex

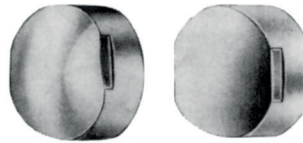

EM803-03 30 gr.
1 Plastik disk, düz
1 Plastic disc, flat
1 Plastik disk, konvex
1 Plastic disc, convex



EM803-10
Anahtar/Wrench



Çekicinin başlıklarına göre ağırlıkları değişebilir
Weights refer to heads of the mallets



Ø 30 mm

COTTLE
EM815-01 235 gr
Bir tarafı düz, bir tarafı bombeli
Bir side flat, bir side convex
18.5cm

1/2



HEATH
EM816-01 660 gr
Ø 40 mm 18.5 cm
EM816-03 725 gr
Ø 45 mm 20 cm
Ağır ekiç
Triphammer



Ø 30 mm

BERGMANN
EM818-02 245 gr
23.5 cm

1/2



Ø 40 mm

OMBREDANNE
EM820-02 520 gr
24 cm

1/2

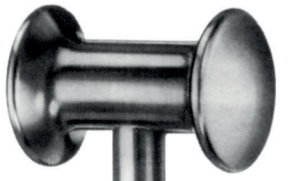

Ø 45 mm

Çekiçin başlıklarına göre ağırlıkları değişebilir
Weights refer to heads of the mallets

1/2

BERGMANN
EM819-02 300 gr
24.5 cm



Ø 30 mm

Ø 42 mm

1/2

EM822-02 285 gr
24 cm

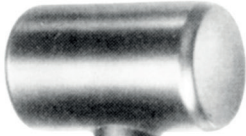

143° buhar sterilizatörlerinde steril edilebilir.
Can be sterilized in a steam sterilizer up to 143°
POM malzeme / POM material

1/2

EM805-01 Ø 35 mm
EM805-02 Ø 42 mm
EM805-03 Ø 50 mm
25 cm

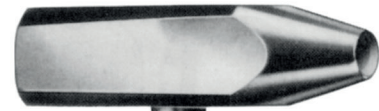

Ø 27 mm

Ø 13.5 mm

1/2

EM821-02 425 gr
Implantlara uygun
ortopedik çekiç
Head made of material
used for implants
23.5 cm





Ø 35 mm

Diskler olmadan çekiç kafa 125 gr
Mallet head without disks 125 gr

WAGNER
EM803-00S Komple/Complete
Metal disk M 803.02/Metal disc M 803.02
Plastik disk M 803.03/Plastic disc M 803.03
Anahtar M 803.10/Wrench M 803.10
23.5 cm

1/2

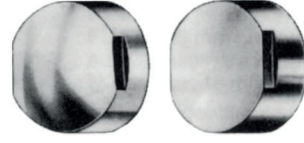

EM803-02 215 gr.
1 Metal disk, düz
1 Metal disc, flat
1 Metal disk, konveks
1 Metal disc, convex

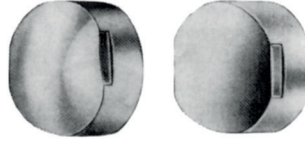

EM803-03 30 gr.
1 Plastik disk, düz
1 Plastic disc, flat
1 Plastik disk, konveks
1 Plastic disc, convex

EM803-10
Anahtar/Wrench



HEATH
EM816-01S
660 gr
Ø 40 mm 18.5 cm

1/2



HEATH
EM816-03S
725 gr
Ø 45 mm 20 cm
Ağır çekiç
Triphammer

1/2



Ø 45 mm



**BERGMANN
EM819-02S**
300 gr
24.5 cm

1/2



Ø 30 mm

Ø 42 mm



285 gr
24 cm

1/2



Ø 27 mm

Ø 13.5 mm



EM821-02S
425 gr
Implantlara uygun
ortopedik çekiç
Head made of material
used for implants
23.5 cm

1/2



mm



**OMBREDANNE
EM820-02S**
520 gr
24 cm

1/2



