

EJN

KJinekolojik Aletler
Gynaecolojik Instruments

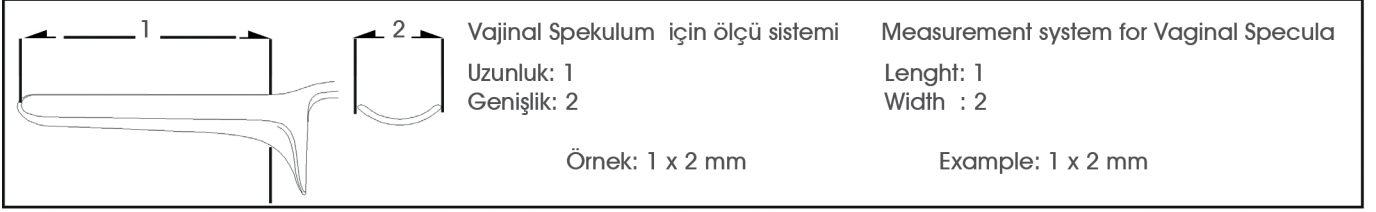



COLLIN
EL750-01
53 x 10 mm
Çocuklar için/For children



COLLIN
EL752-01
95/85 x 18 mm
Bakireler için/For virgins

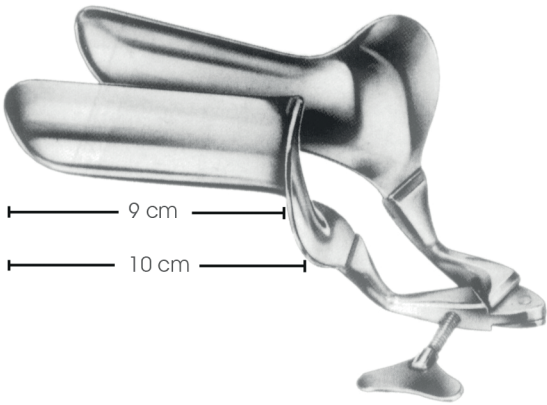

COLLIN	Tam boy/Çalışma boy Total length/Working length	En Width
EL754-01	100/90 mm	28 mm
EL754-02	100/90 mm	32 mm
EL754-03	105/95 mm	35 mm
EL754-04	115/105 mm	40 mm

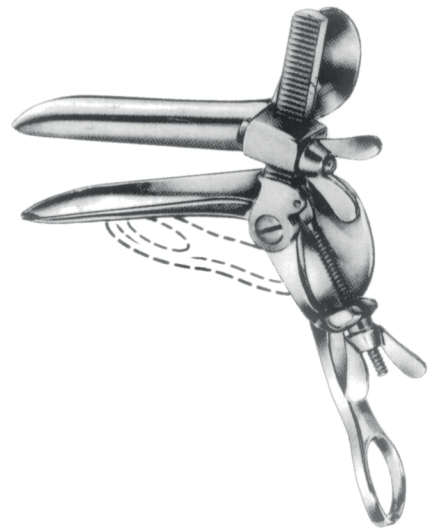

TRELAT	
EL785-01	85 x 33 mm
EL785-02	95 x 35 mm
EL785-03	115 x 43 mm

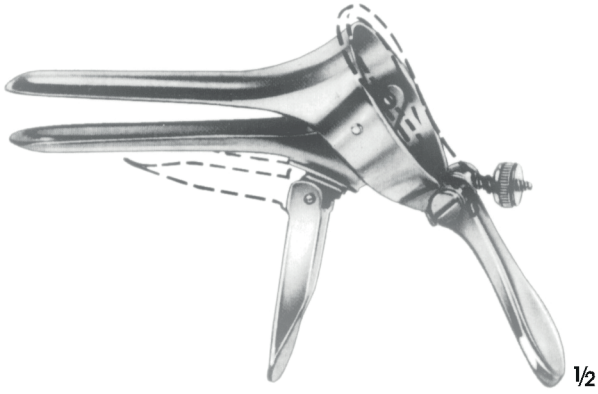

CUSCO
EL760-01
75 x 17 mm
Bakireler için/For virgins

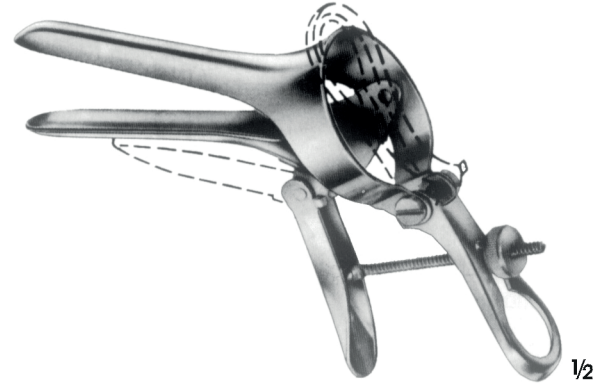

CUSCO
EL770-01
75 x 17 mm
Bakireler için/For virgins



CUSCO STANDARD
EL762-01 80 x 24 mm
EL762-02 80 x 32 mm
EL762-03 90 x 36 mm
EL762-04 110 x 37 mm
Standart model
Standard patterns



İsviçre örneği
Özellikleri: Uzun ve dar
Swiss patterns
Fatures: Long and narrow

CUSCO
EL763-01 92 x 23 - 25 mm
EL763-02 100 x 25 - 27 mm
EL763-03 110 x 27 - 30 mm





CUSCO
EL765-01 80 x 32 mm
EL765-02 90 x 37 mm
EL765-04 115 x 37 mm
Yassı (Ördek gagası)
Flat (Duck beak)

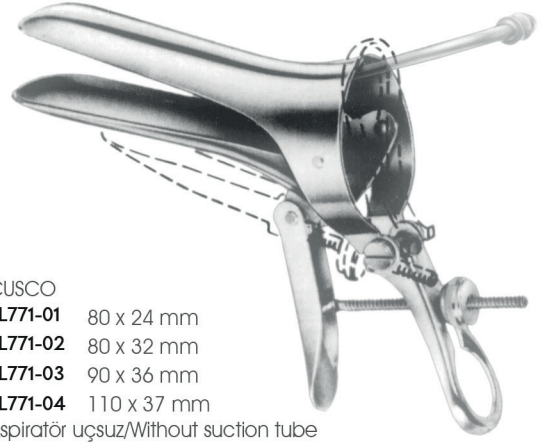

CUSCO
EL771-01 80 x 24 mm
EL771-02 80 x 32 mm
EL771-03 90 x 36 mm
EL771-04 110 x 37 mm
Aspiratör uçsuz/Without suction tube
EL771-05 107 x 29 mm
EL771-06 115 x 35 mm
Aspiratör uçlu/With suction tube



GRAVE
EL790-01 75 x 20 mm
EL790-02 95 x 30 mm
EL790-03 105 x 33 mm



PEDERSON
EL791-01 100 x 22 mm
EL791-02 120 x 25 mm

Parmak baskısıyla açılıp kapanan çift işaretili
With double ratchet, closing and opening of
ratchet by pressure of thumb

SEMM
EL780-01
90 x 14 - 18 mm
Çocuk ve bakireler için
For children and virgins



Parmak baskısıyla açılıp kapanan çift işaretili
With double ratchet, closing and opening of
ratchet by pressure of thumb

SEMM
EL781-01 100 x 20 - 24 mm
EL781-05 100 x 30 - 34 mm
18.5 cm



SEYFFERT
EL782-01 100 x 17 mm
EL782-05 100 x 33 mm
23 cm

Alet ve kataterleri çıkarmak için bir tarafı açık
One side open for faking up instruments and
catheters



SEYFFERT
EL783-01 110 x 33 mm
23 cm



SEIDL
EK804-01 80 x 8 mm
EK804-02 80 x 10 mm
EK804-03 90 x 14 mm
Çocuklar ve bebekler için
For children and infants
17 cm



KRISTELLER
EK806-01 70 x 15 mm
Çocuklar için
For children
17 cm



KRISTELLER
EK807-01 70 x 27 mm
EK807-02 75 x 30 mm
EK807-03 90 x 36 mm
17.5 cm



KRISTELLER
EK809-02 110 x 18 mm
EK809-03 110 x 20 mm
EK809-04 110 x 27 mm
EK809-05 110 x 30 mm
EK809-06 110 x 36 mm
22 cm

KRISTELLER
EK814-00-EK814-03
Üst bleyd/Upper blades



EK814-00
75 x 10 mm
17.5 cm



EK814-01
75 x 23 mm
18 cm



EK814-02
80 x 25 mm
18 cm



EK814-03
100 x 32 mm
18.5 cm

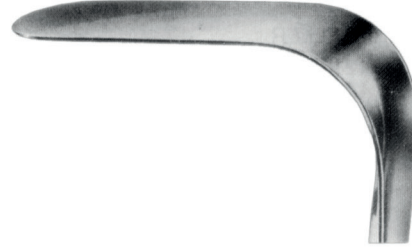

1/2

KRISTELLER
EK812-00-EK812-03
Alt bleyd/Lower blade



EK812-00
70 x 15 mm
17.5 cm



EK812-01
70 x 27 mm
18 cm



EK812-02
75 x 30 mm
18 cm



EK812-03
90 x 36 mm
18.5 cm



1/2





KRISTELLER
EK814-04-EK814-08
Üst bleyd/Upper blades



KRISTELLER
EK812-04-EK812-08
Alt bleyd/Lower blades

EK814-04
115 x 14 mm
21.5 cm



EK814-05
115 x 23 mm
21.5 cm

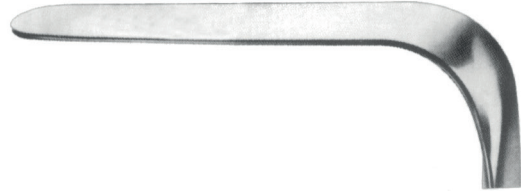

EK814-06
115 x 16 mm
22 cm

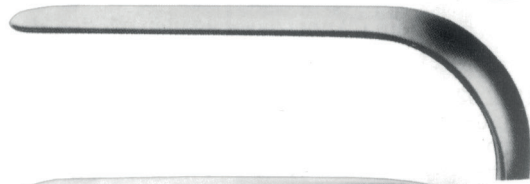

EK814-07
115 x 26 mm
22 cm

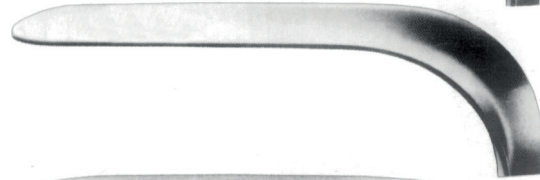

EK814-08
120 x 30 mm
22.5 cm



1/2

EK812-04
110 x 18 mm
21.5 cm

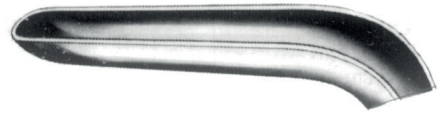

EK812-05
110 x 27 mm
21.5 cm

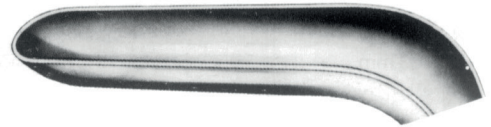

EK812-06
110 x 20 mm
22 cm



EK812-07
110 x 30 mm
22 cm

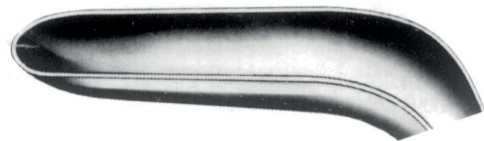

EK812-08
110 x 36 mm
22.5 cm

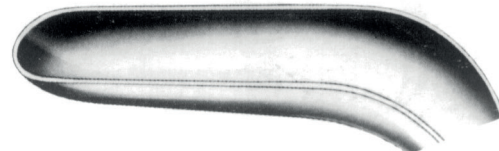

1/2



KRISTELLER
EK817-02-EK817-04
Üst bleyd/Upper blades
20.5 cm

1/2

EK817-02
80 x 28 mm



EK817-03
85 x 35 mm



EK817-04
85 x 40 mm



1/2



JACKSON
EK819-02-EK819-04
Alt bleyd/Lower blades

1/2

EK819-02
76 x 38 mm



EK819-03
89 x 38 mm



EK819-04
102 x 38 mm

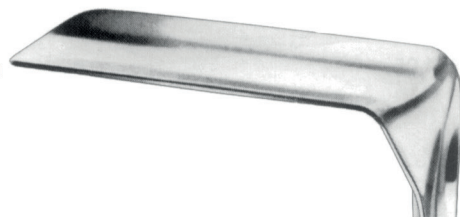

1/2





KALLMORGEN
EK825-01 Set/Set
75 x 39 mm
17 cm

1/2



KALLMORGEN
EK826-01 Set/Set
95 x 39 mm
20 cm

1/2

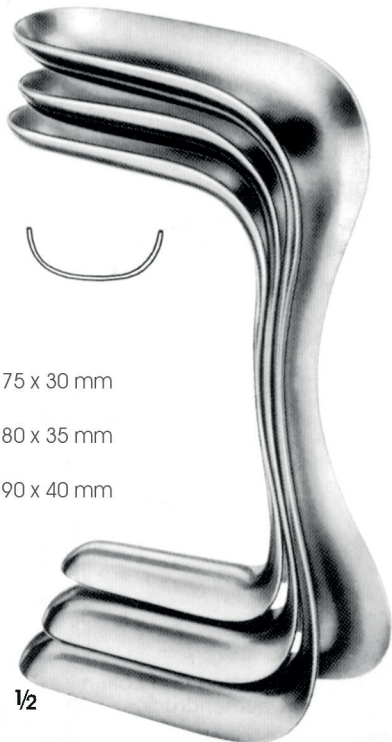

SIMS
EK832-01 70 x 26 / 75 x 30 mm
12.5 cm
EK832-05 75 x 30 / 80 x 35 mm
15 cm
EK832-08 80 x 36 / 90 x 40 mm
17.5 cm

1/2



BREISKY
EK830-01 72 x 25 / 77 x 30 mm
14 cm
EK830-05 75 x 30 / 92 x 38 mm
17 cm

1/2

EK841-03
110 x 20 mm



EK841-04
110 x 30 mm



EK841-05
110 x 36 mm



EK841-03-EK841-05
Alt bleyd/Lower blade
21.5 cm

EK841-06
115 x 18 mm

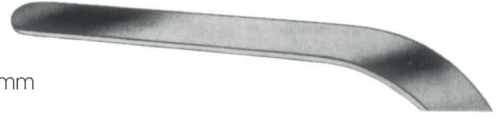

EK841-07
115 x 26 mm



EK841-08
115 x 32 mm



KRISTELLER
EK841-00 110 x 20 mm
EK841-01 110 x 30 mm
EK841-02 110 x 36 mm
Viyana model set
Vienna patterns sets

1/2



KRISTELLER
EK841-06-EK817-08
Üst bleyd/Upper blade
22 cm

1/2





1/2
BRAUN
EK850-01
56 x 13 mm
18 cm

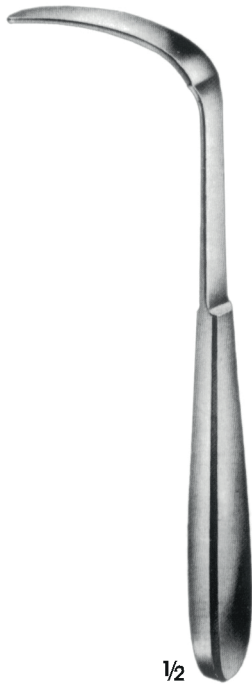

1/2
BRAUN
EK851-01
60 x 10 mm
18 cm



1/2
HEANEY
EK815-00
89 x 29 mm
17 cm



1/2
EASTMAN
EK818-00
89 x 38 mm
17.5 cm



1/2
LONDON
EK854-00
89 x 25 mm
19.5 cm



1/2
MATHIEU
EK843-01
İç bleyd/Inner blade
95 x 17 - 30 mm
21 cm



1/2
MATHIEU
EK844-01
Üst bleyd/Upper blade
95 x 17 - 26 mm
(İç bleyd/Inner blade K 843.01)
21 cm

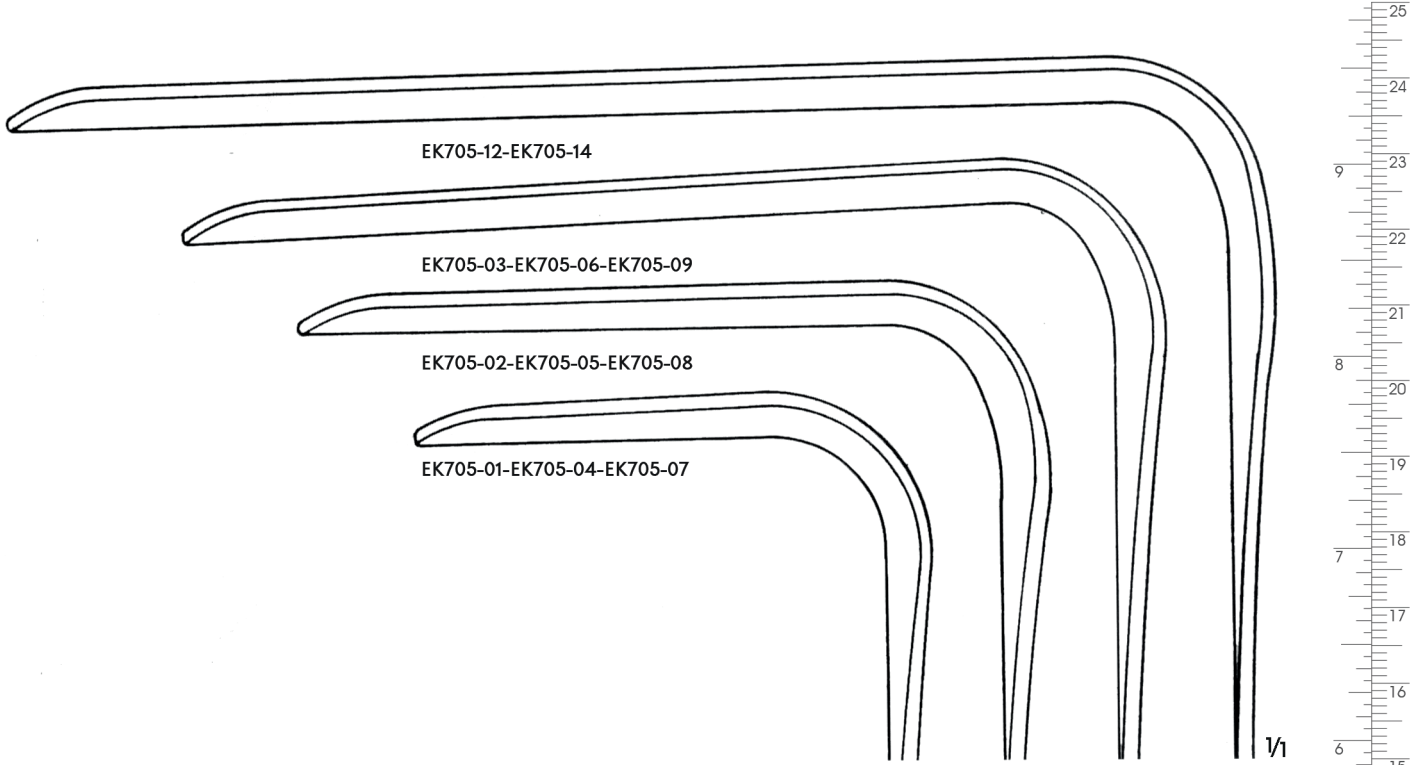

DOYEN
EK705-01-EK705-14
24 cm

Ağız uzunlukları Length of blades	Ağız genişlikleri Widh of blades		
60 mm	EK705-01	EK705-04	EK705-07
90 mm	EK705-02	EK705-05	EK705-08
120 mm	EK705-03	EK705-06	EK705-09
160 mm	-	EK705-12	EK705-14



LANDAU
EK680-02 100 x 28 mm
EK680-04 110 x 38 mm
29 cm

1/2



BREISKY
EK682-02 100 x 20 mm
EK682-03 100 x 25 mm
EK682-04 100 x 30 mm
EK682-05 100 x 35 mm
EK682-06 100 x 40 mm
Viyana Model
Vienna patterns
30 cm

1/2



BREISKY
EK683-02 130 x 20 mm
EK683-03 130 x 25 mm
EK683-04 130 x 30 mm
EK683-05 130 x 35 mm
EK683-06 130 x 40 mm
Viyana Model
Vienna patterns
32 cm

1/2



BREISKY
EK684-02 160 x 40 mm
EK684-03 180 x 40 mm
Viyana Model
Vienna patterns
35 cm

1/2

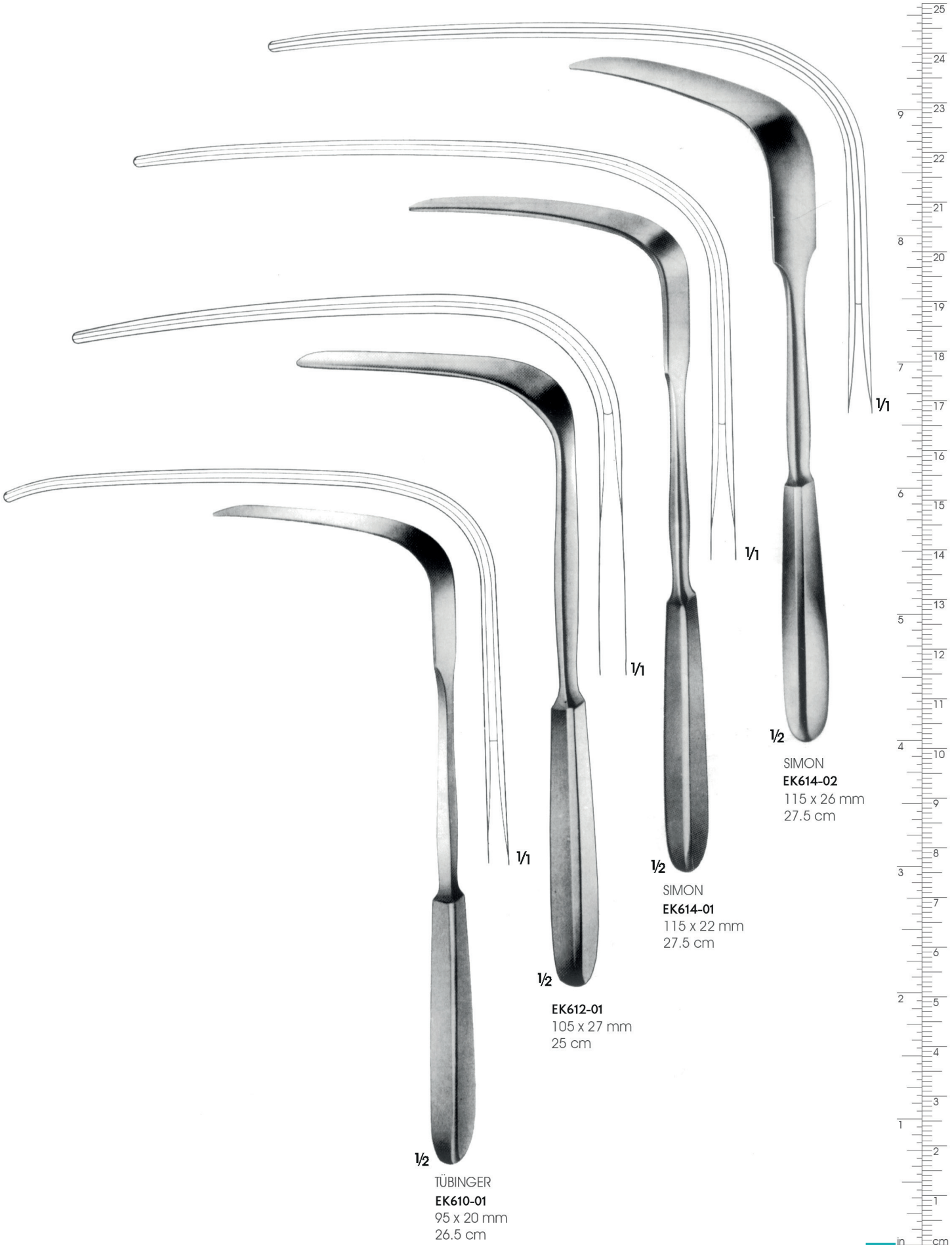

$\frac{1}{2}$
TÜBINGER
EK610-01
95 x 20 mm
26.5 cm

$\frac{1}{2}$
EK612-01
105 x 27 mm
25 cm

$\frac{1}{2}$
SIMON
EK614-01
115 x 22 mm
27.5 cm

$\frac{1}{2}$
SIMON
EK614-02
115 x 26 mm
27.5 cm



DOYEN
EK706-01-EK706-03
23.5 cm

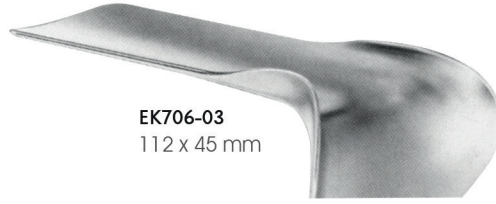

EK706-03
112 x 45 mm

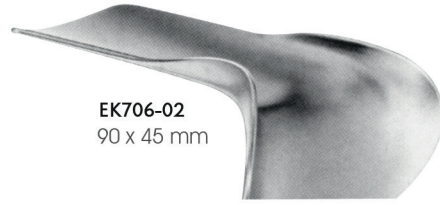

EK706-02
90 x 45 mm

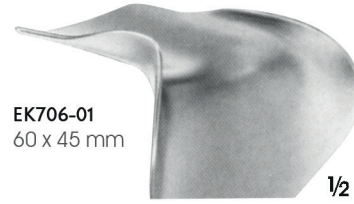

EK706-01
60 x 45 mm



DOYEN
EK856-01
Yanal spekulum
Lateral speculum
23 cm



DOYEN
EK857-01
Yanal spekulum
Lateral speculum
25 cm



WEISSBARTH
EK868-01 80 x 28 mm
EK868-02 85 x 42 mm
21 cm
EK868-03
Sökülebilir süzgeçli
Removable strainer only



AUVARD
EK864-00
65 x 38-28 mm
1.530 gr.
Sökülebilir ağırlıklı
With detachable weight
23 cm



AUVARD
EK863-01 75 x 42-40 mm
EK863-02 105 x 43-40 mm
1.470 gr. sökülebilir ağırlıklı
With detachable weight
23 cm



AUVARD
EK862-01
65 x 38-28 mm
1.530 gr.
Sabit ağırlık
Fixed weight
23 cm



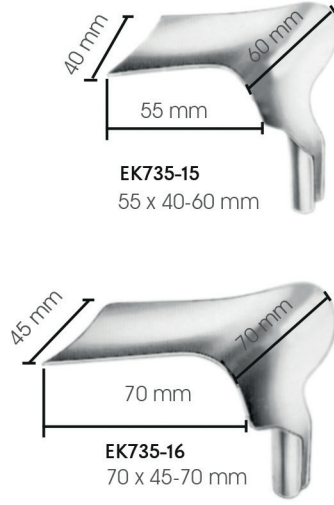

(K 735.10-K 735.16 ve K 735.20-K 735.27) birbirleriyle deđiřtirilebilir.
(K 735.08 ve K 735.09) saplarına olduđu gibi (K 735.01)'yada uyar.
The mentioned blades (K 735.10-K 735.16 and K 735.20-K 735.27)
can be exchanged. They fit handle K 735.01 as well as handles
K 735.08 and K 735.09.

SCHERBACK
T 791.00 Komple/Complete
(K 735.01) Sap/Handle
(T 790.00) Ađırlık/Weight
(K 735.10-K 735.15)4 Bleyd/4 Blades

1/3



BOZEMANN
EK735-30 Set/Set
(K 735.08-K 735.09) 2 Sap/2 Handles
(K 735.20-K 735.27) 8 Bleyd/8 Blades



GELPI
EL408-00
13.5 cm

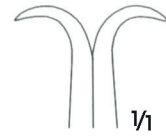

GELPI
EL409-00
17.5 cm



RICHTER
EL412-00
17 cm



JOLL (FRIEDMANN)
EL417-00
15.5 cm





HEGAR
EK750-01-EJ751-17
Sivri uçlu dilatörler
With very conical point
18.5 cm

EJ750-01	1 mm	EJ750-14	14 mm	EJ751-01	1.5 mm	EJ751-14	14.5 mm
EJ750-02	2 mm	EJ750-15	15 mm	EJ751-02	2.5 mm	EJ751-15	15.5 mm
EJ750-03	3 mm	EJ750-16	16 mm	EJ751-03	3.5 mm	EJ751-16	16.5 mm
EJ750-04	4 mm	EJ750-17	17 mm	EJ751-04	4.5 mm	EJ751-17	17.5 mm
EJ750-05	5 mm	EJ750-18	18 mm	EJ751-05	5.5 mm		
EJ750-06	6 mm	EJ750-19	19 mm	EJ751-06	6.5 mm		
EJ750-07	7 mm	EJ750-20	20 mm	EJ751-07	7.5 mm		
EJ750-08	8 mm	EJ750-21	21 mm	EJ751-08	8.5 mm		
EJ750-09	9 mm	EJ750-22	22 mm	EJ751-09	9.5 mm		
EJ750-10	10 mm	EJ750-23	23 mm	EJ751-10	10.5 mm		
EJ750-11	11 mm	EJ750-24	24 mm	EJ751-11	11.5 mm		
EJ750-12	12 mm	EJ750-25	25 mm	EJ751-12	12.5 mm		
EJ750-13	13 mm	EJ750-26	26 mm	EJ751-13	13.5 mm		



HEGAR
EJ754-01-EJ754-09
19.5 cm

EJ754-01	1 + 2 mm
EJ754-02	3 + 4 mm
EJ754-03	5 + 6 mm
EJ754-04	7 + 8 mm
EJ754-05	9 + 10 mm
EJ754-06	11 + 12 mm
EJ754-07	13 + 14 mm
EJ754-08	15 + 16 mm
EJ754-09	17 + 18 mm

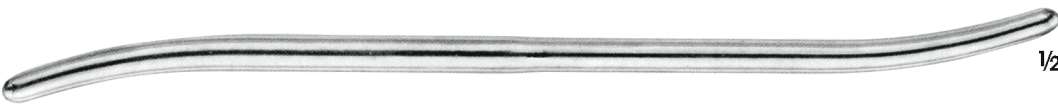

PRATT
EJ756-01-EJ756-08
29 cm

EJ756-01	13 - 15 Charr.
EJ756-02	17 - 19 Charr.
EJ756-03	21 - 23 Charr.
EJ756-04	25 - 27 Charr.
EJ756-05	29 - 31 Charr.
EJ756-06	33 - 35 Charr.
EJ756-07	37 - 39 Charr.
EJ756-08	41 - 43 Charr.

EJ790-00

Set (J 750.04-J 750.17) 14 parça
Set (J 750.04-J 750.17) 14 piece
Y 310.10WV 1 adet, Y 380.03F 1 adet, Y 840.00 15 adet,
Y 841.01 1 adet, Y 842.00 2 adet dahildir.
With Y 310.10WV 1 each, Y 380.03F 1 each,
Y 840.00 15 each, Y 841.01 1 each,
Y 842.00 2 each.

EJ790-01

Set (J 751.04-J 751.17) 14 parça
Set (J 751.04-J 751.17) 14 piece
Y 310.10WV 1 adet, Y 380.03F 1 adet, Y 840.00 15 adet,
Y 841.01 1 adet, Y 842.00-2 adet dahildir.
With Y 310.10WV 1 each, Y 380.03F 1 each, Y 840.00 15
each, Y 841.01 1 each, Y 842.00 2 each.

EJ792-00

Tam set 28 parça/Full set 28 piece
Set (J 750.04-J 750.17)+(J 751.04-J 751.17)
Y 110.10WV 1 adet, Y 181.05F 1 adet, Y 840.00 31 adet,
Y 841.01 1 adet, Y 842.01 2 adet dahildir.
With Y 110.10WV 1 each, Y 181.05F 1 each, Y 380.03F
1 each, Y 840.00 15 each, Y 841.01 1 each, Y 842.00
2 each.

EY841-00 230 mm

EY841-01 470 mm

Y 840.00 bölücü için sürgülü
ray, güvenlik vidaları ile
Sliding rails with securing
screws, for divider Y 840.00

EY842-00 230 mm

EY842-01 470 mm

Sınırlayıcı kalıp, güvenlik vidaları
ile özellikle depolama dilatörü
için uygun
Limiting bars with securing
screws, particularly usefel for
storing dilators

EY840-00

Bölücü, Y 841.00 için
Divider, to be used with Y 841.00

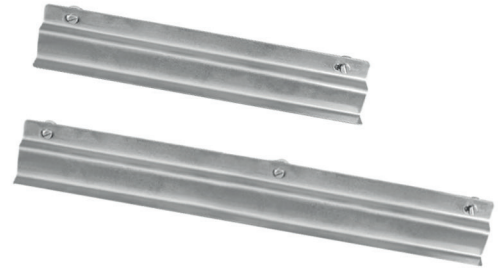

Konteyner/Container



EY310-10WV	285 x 280 x 100 mm
EY310-13WV	285 x 280 x 135 mm
EY310-15WV	285 x 280 x 150 mm
EY310-20WV	285 x 280 x 200 mm
EY310-26WV	285 x 280 x 260 mm

Konteyner/Container



EY110-10WV	580 x 280 x 100 mm
EY110-13WV	580 x 280 x 135 mm
EY110-15WV	580 x 280 x 150 mm
EY110-20WV	580 x 280 x 200 mm
EY110-26WV	580 x 280 x 260 mm

Tel sepetler/Wire baskets

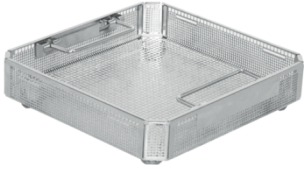

EY380-03F	242 x 252 x 40 mm
EY380-05F	242 x 252 x 60 mm
EY380-07F	242 x 252 x 80 mm
EY380-10F	242 x 252 x 110 mm

Tel sepetler/Wire baskets

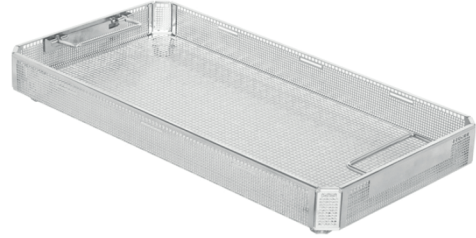

EY181-03F	539 x 252 x 40 mm
EY181-05F	539 x 252 x 60 mm
EY181-07F	539 x 252 x 80 mm
EY181-10F	539 x 252 x 110 mm

Tel taban/Wire Base



EY393-00	258 x 258 x 30 mm
-----------------	-------------------

Tel taban/Wire Base

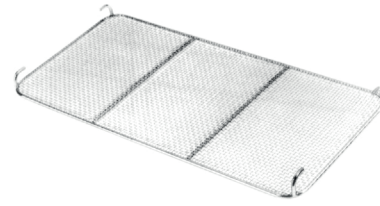

EY193-00	545 x 255 x 30 mm
-----------------	-------------------

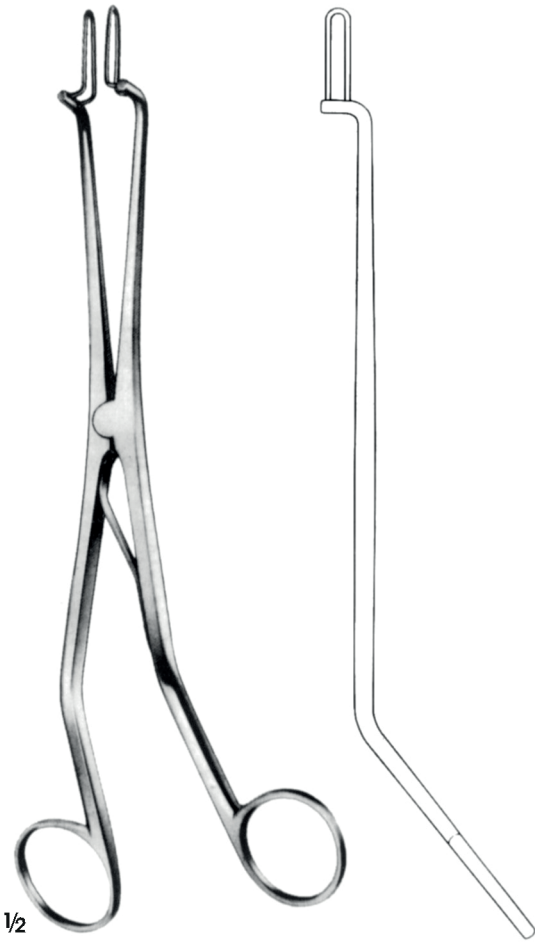

KOGAN
EY400-01
Kiltsiz/Without ratchet
24 cm

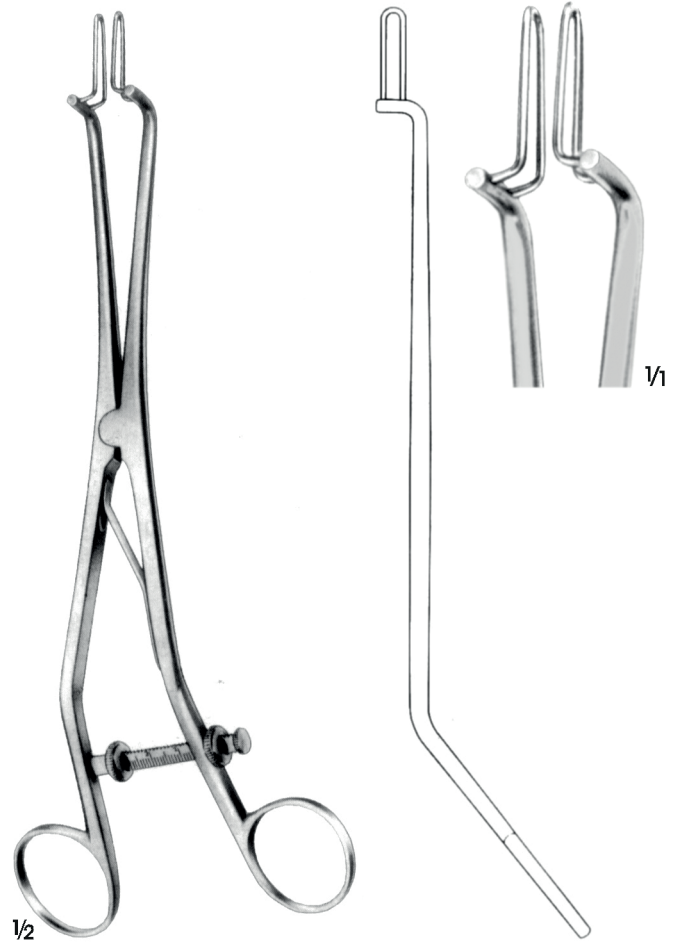

KOGAN
EY401-01
Ölçülü sabitleyici ayar vidası
With scale-ratchet and fixing screw
24 cm

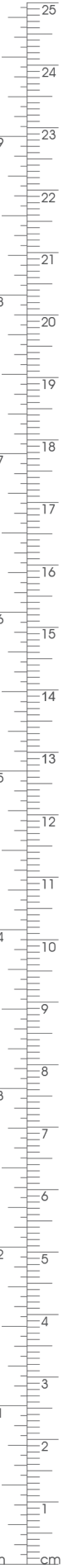

Ø 5 mm



1/2

MAYO
EJ650-05
Bükülebilir/Malleable
33 cm

Ø 4 mm



1/2

SIMS
EJ652-05 33 cm
EJ652-08 33 cm
Bükülebilir/Malleable

Ø 3 mm



1/2

EJ653-05
30 cm

Ø 4 mm



1/2

SIMPSON
EJ656-05
Bükülebilir/Malleable
31 cm

Ø 3.6 mm



1/2

GALABINS
EJ654-00

Ölçülü mil, bükülebilir
Shaft graduated in cm, malleable
29.5 cm

Ø 4 mm



1/2

VALLEIX
EJ658-05

Ölçü kaydırıcı, göstergeli
Graduated, with slider
25 cm

24 mm



1/2

BRAUN
EK390-03

Uterin bastırıcı
Uterine depressor
27 cm



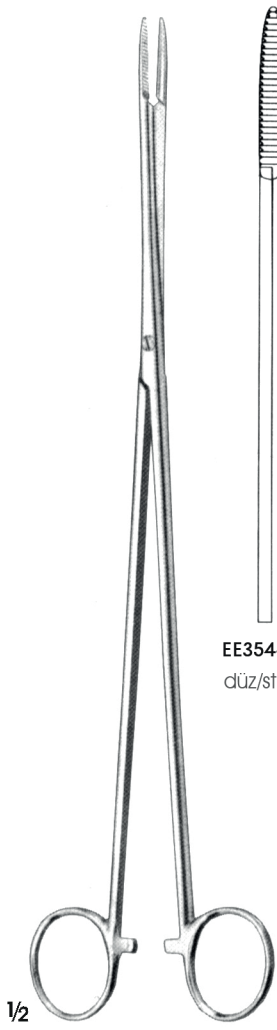

EE354-00
düz/straight

EE355-00
eğri/curved

PELKMANN
EE354-00-EE355-00
26 cm

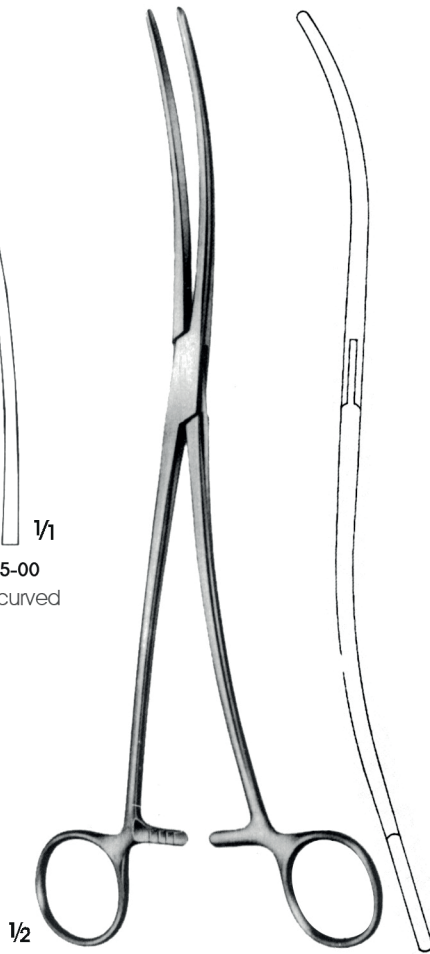

BOZEMANN
EE360-02
25 cm

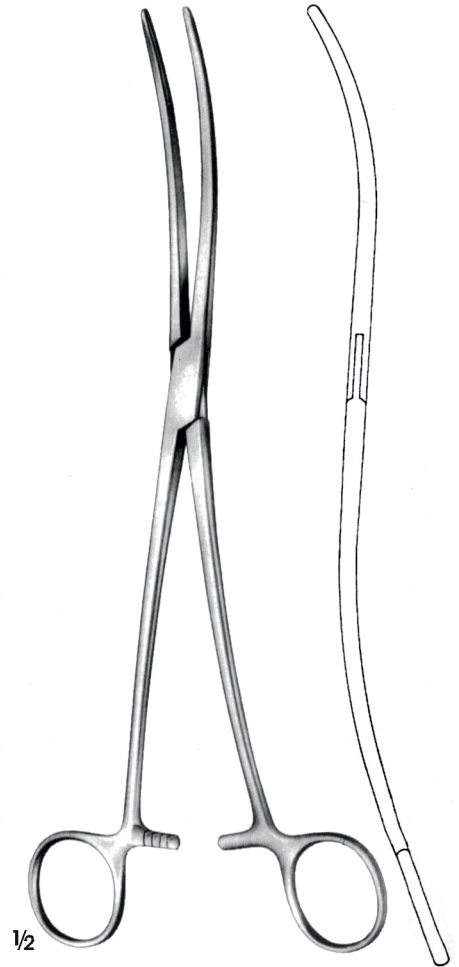

BOZEMANN
EE362-02
Ağız oluklu pens
Jaws with longitudinal
groove
25.5 cm

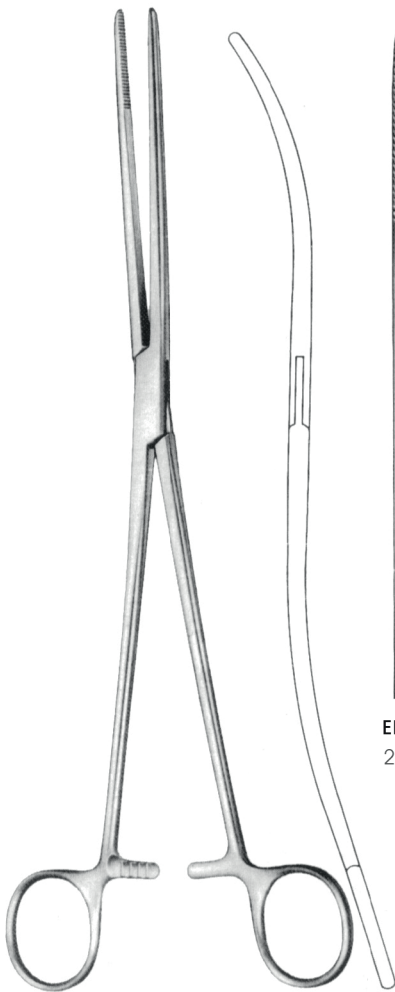

BOZEMANN
EE364-02-EE365-02



EE364-02
26 cm



EE365-02
25 cm

1/1

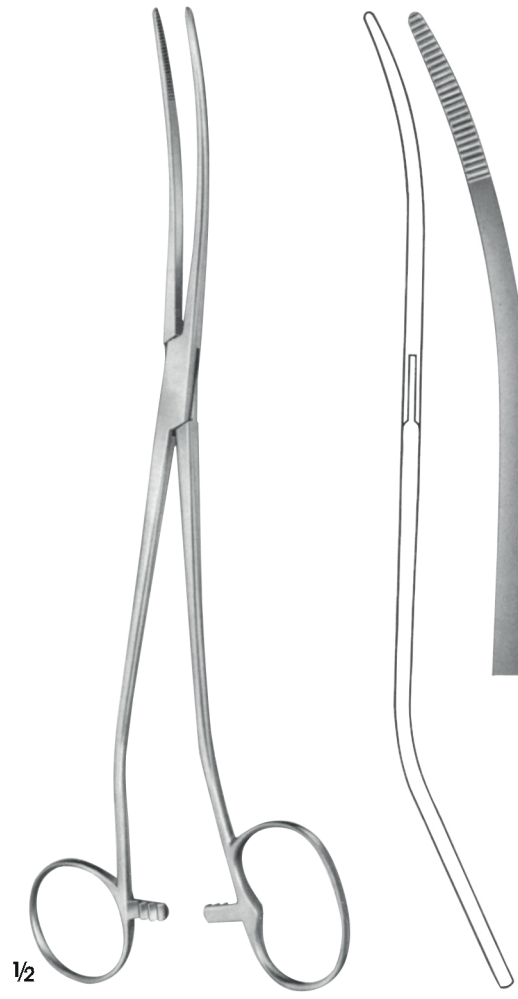

BOZEMANN-DOUGLAS
EE367-02
26 cm

1/2



1/1



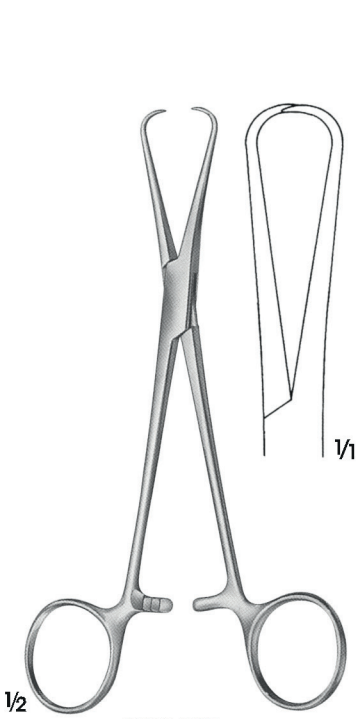

BERNHARD
EE444-00
16 cm



POZZI
EE445-01
17.5 cm

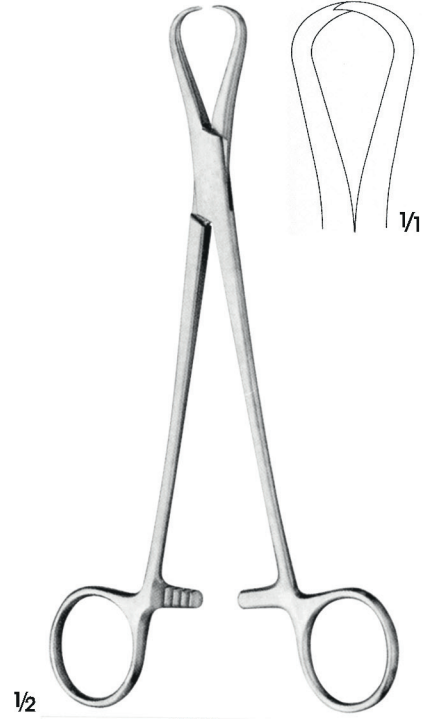

ADAIR
EE443-00
19 cm



BRAUN
EE258-01
Narin Model/Slender pattern
25 cm

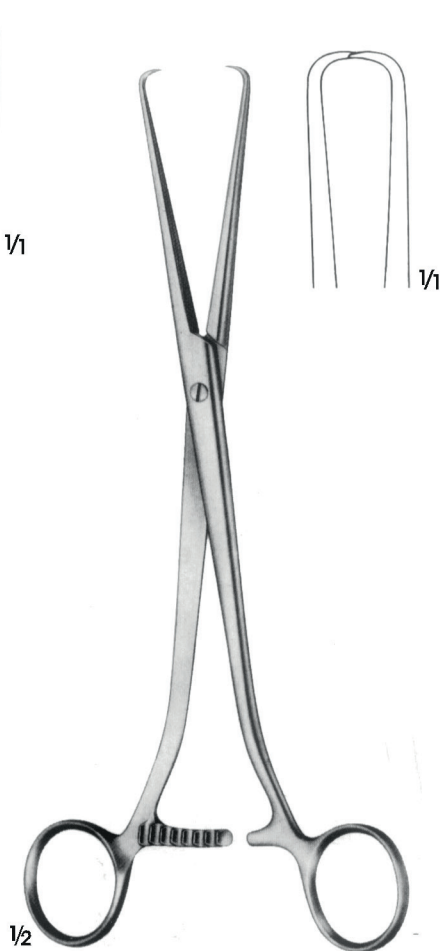

COLLIN-POZZI
EE270-01
25 cm

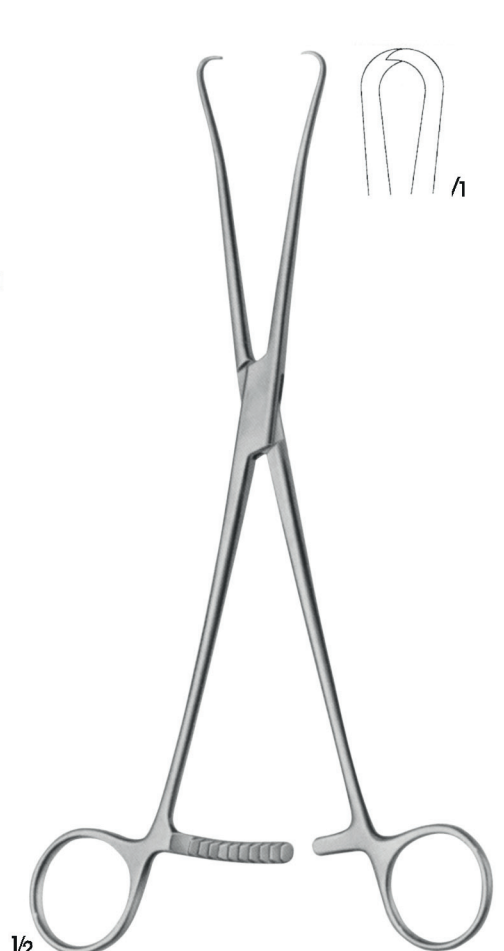

WILSON
EE252-00
24 cm

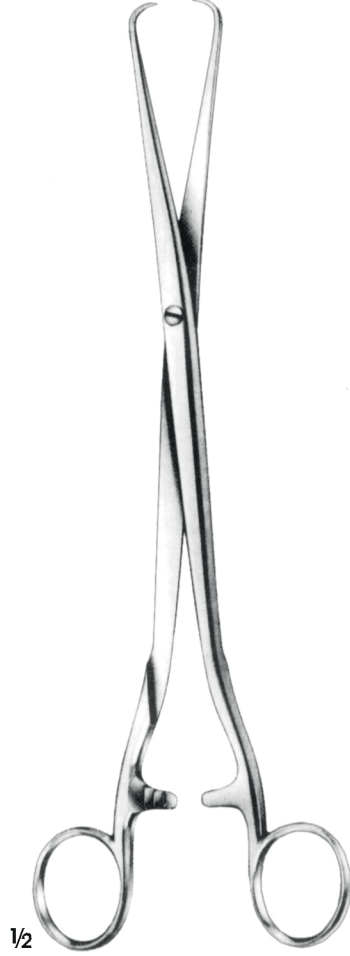
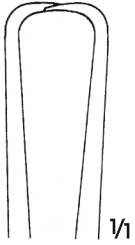

SCHRÖDER
EE251-00
Standart Model
Standart pattern
25 cm

SCHRÖDER
EE253-01
25 cm

POZZI
EE255-01
Zorlu operasyon için
Heavy pattern
25.5 cm



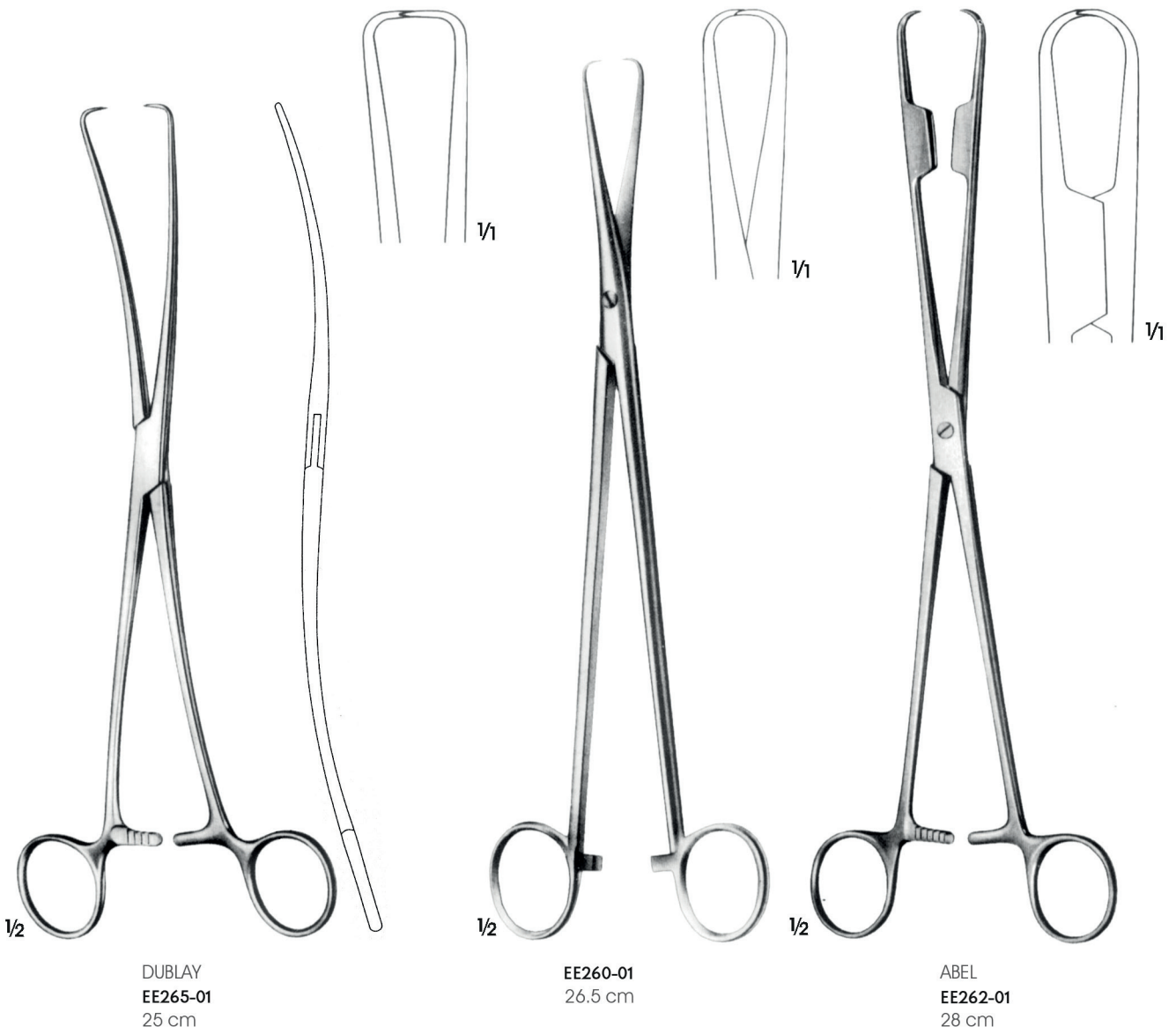



MUSEUX
EE375-01
20 cm



JACOBS
EE376-01
21.5 cm



MUSEUX
EE380-02-EE380-04
24 cm



MUSEUX
EE381-02-EE381-04
26.5 cm



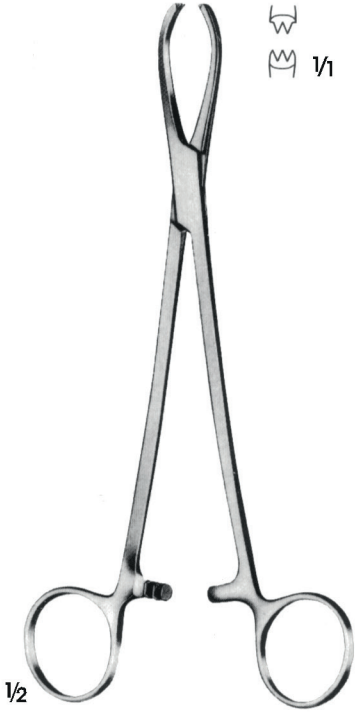

LITTLEWOOD
EE378-02
18.5 cm



TEALE
EE379-02
25.5 cm



MUSEUX
EE382-02-EE382-04
Yana eğri
Curved to side
24 cm



KÜSTNER
EE383-02
25 cm

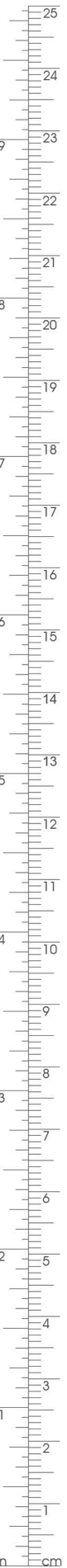
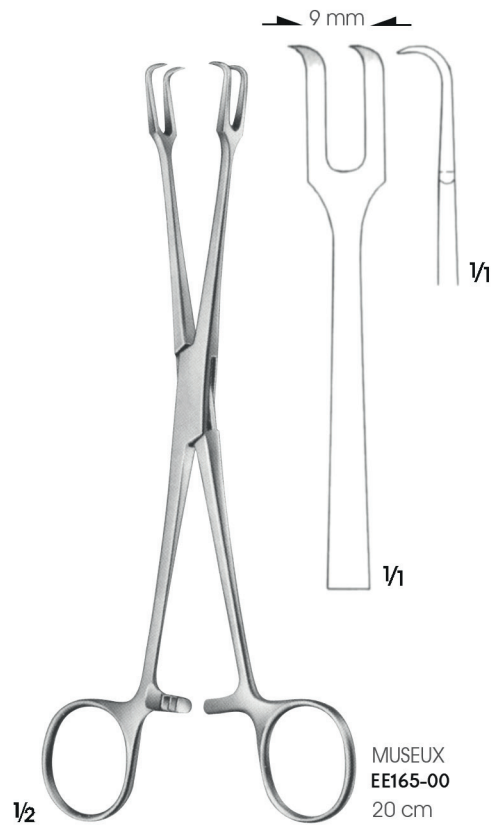
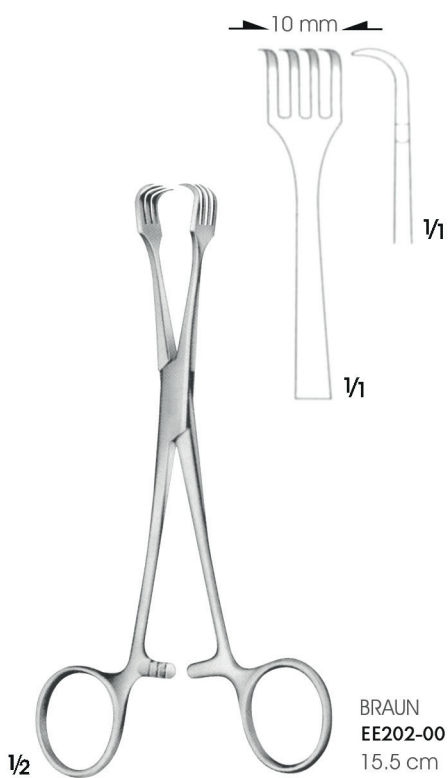
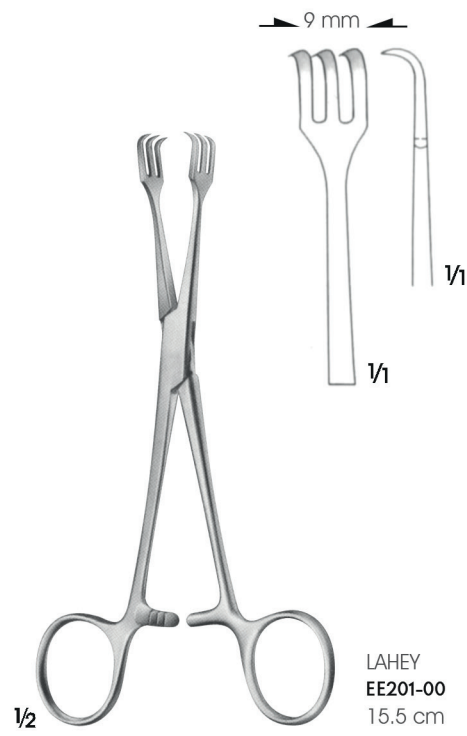
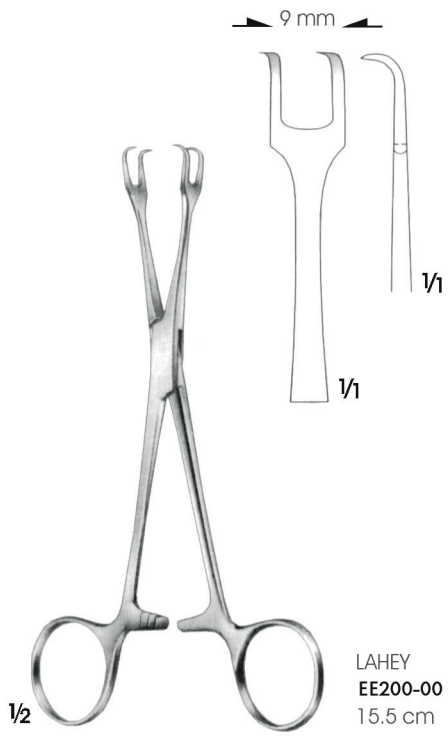

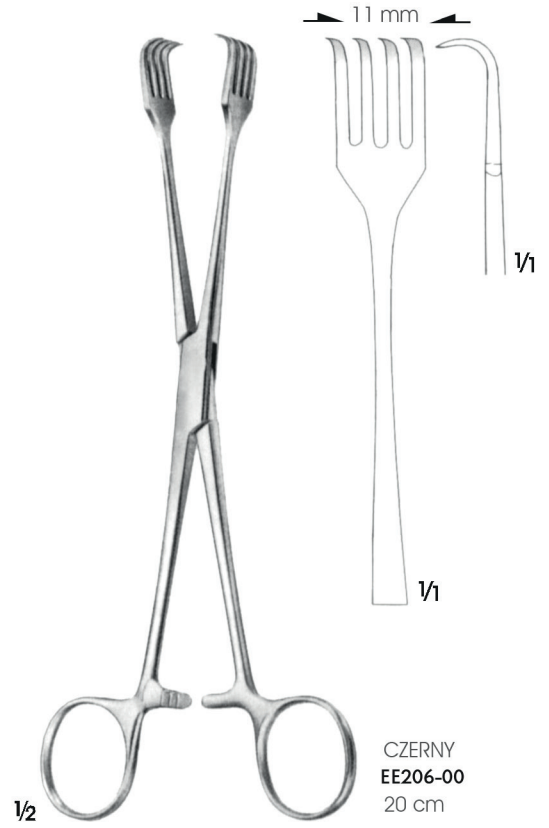
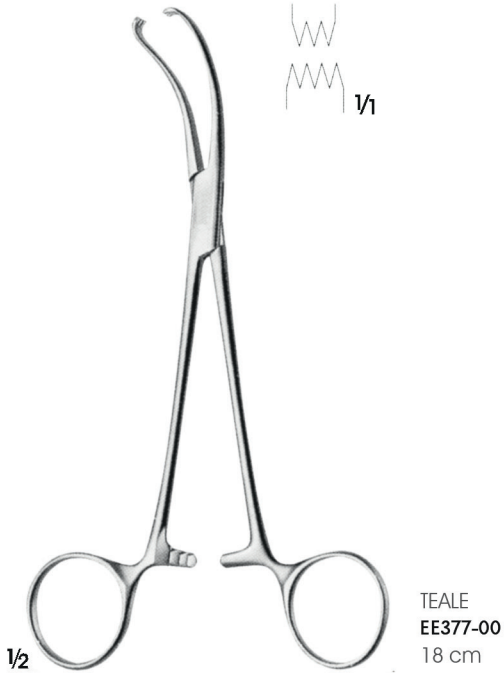

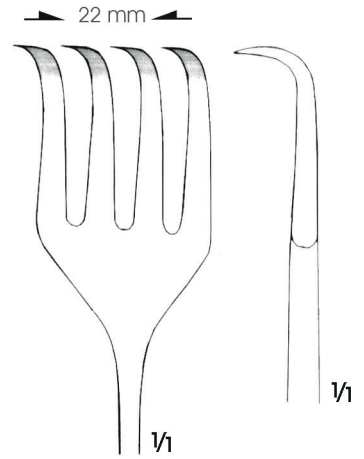
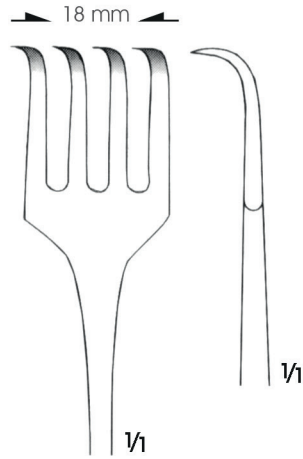
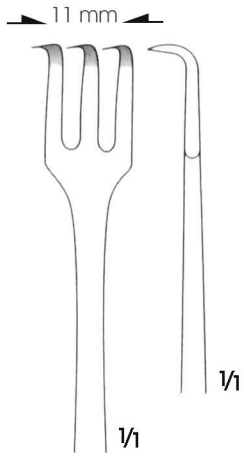

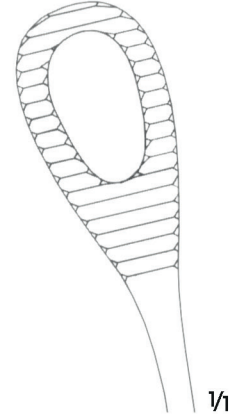
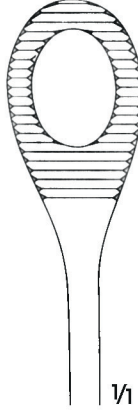

HEYWOOD-SMITH
EE198-00
25 cm

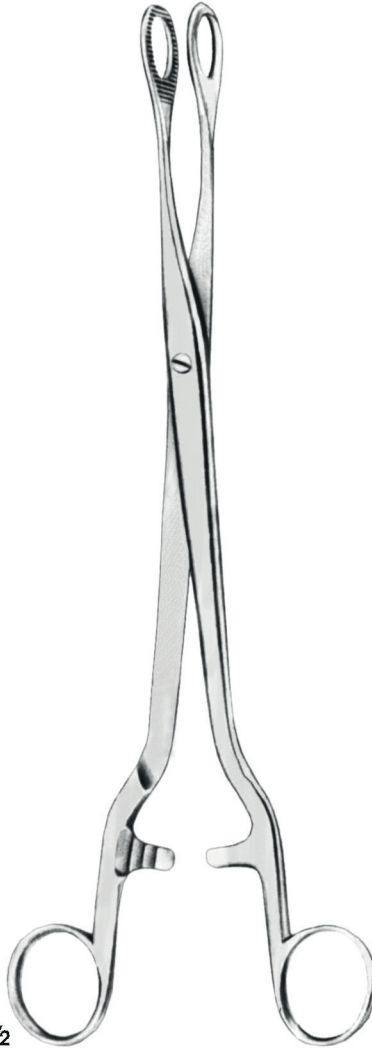

NOTO
EE120-00
28 cm

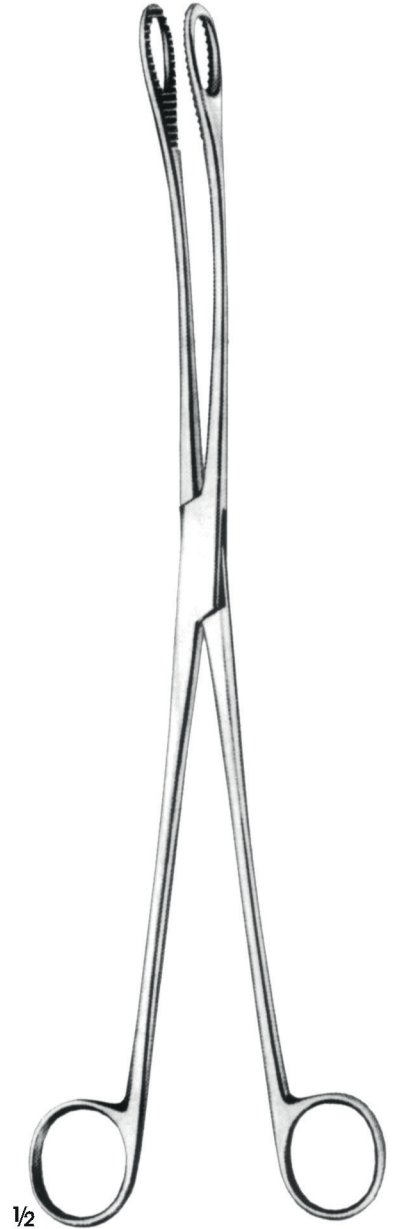

KELLY
EE122-00
32 cm



Atromatik
Atraumatic

21 mm 27 mm

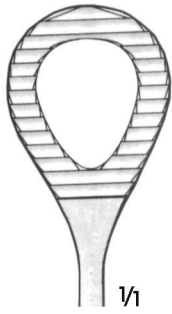
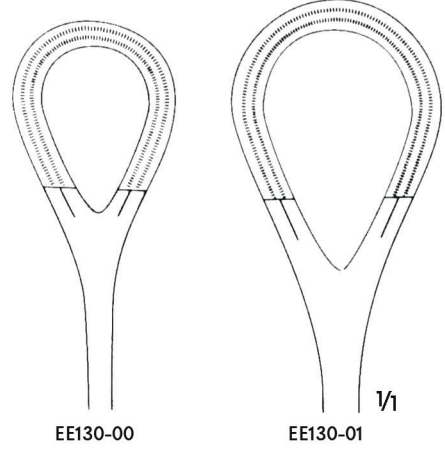

HEYWOOD-SMITH
EE190-00
20 cm

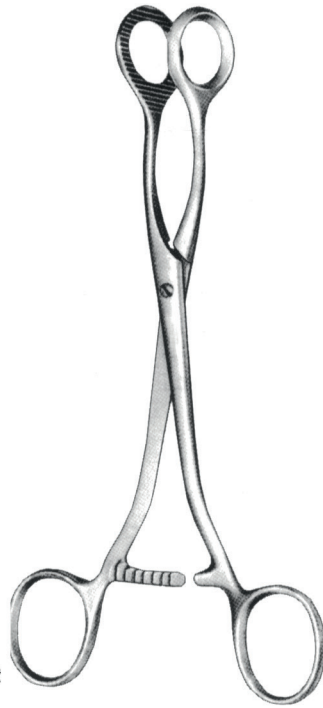

DOYEN
EE196-00
18.5 cm



EE130-00 25 cm
EE130-00 27 cm



1/2

SOMER
EE560-01
23.5 cm



1/2

DARTIGUES
EE575-02
25.5 cm



Hareketli çene
With movable jaws

1/2

COLLIN
EE550-01
26.5 cm

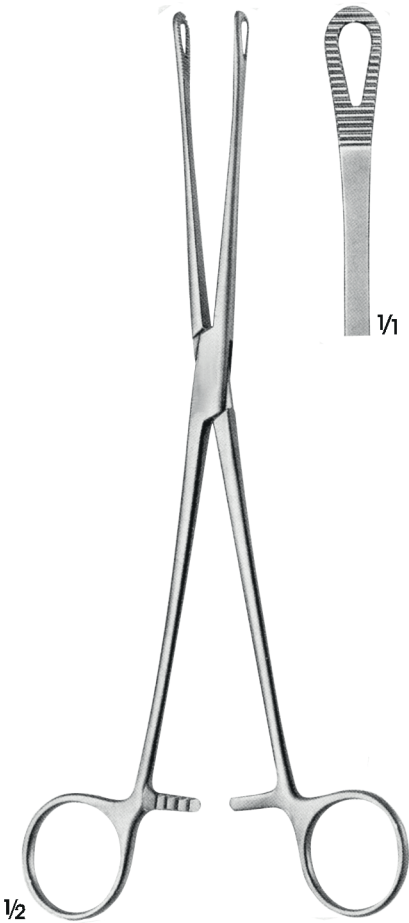

BONNEY
EE088-00
24 cm



COLLIN
EE570-01
25 cm



COLLIN
EE577-02
28.5 cm

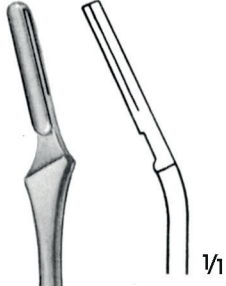

1/1

EB034-01
Açılı bistüri sapı
Scalpel handle, angular curved
22.5 cm



1/2

DOYEN
ET420-00
Myoma burgusu
Myoma screw
15 cm



1/2

DOYEN
ET421-00
Myoma burgusu
Myoma screw
19 cm



KEIBACK
EG675-00 23.5 cm
EG675-02 35 cm
Yan kavisli üretral tünel pençeri
Ureteral tunnel clamps, curved to side

UCHIDA
ET480-00 27 cm
ET480-03 35 cm
Kaşıklar/Spoons

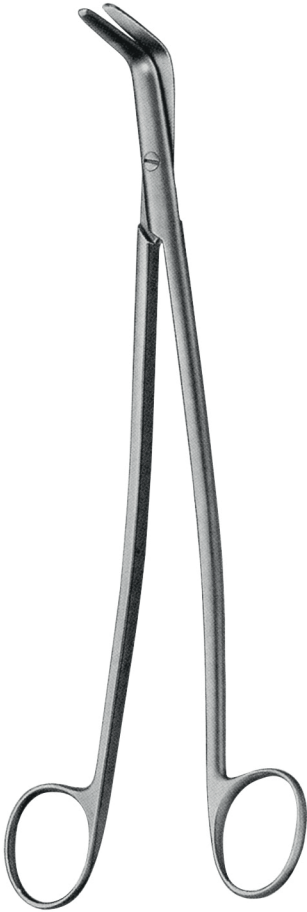

KIEBACK
EC614-00-EC614-02
Parametrium makaslar
Parametrium scissors



EC614-00
24 cm

EC614-02
35 cm

1/1

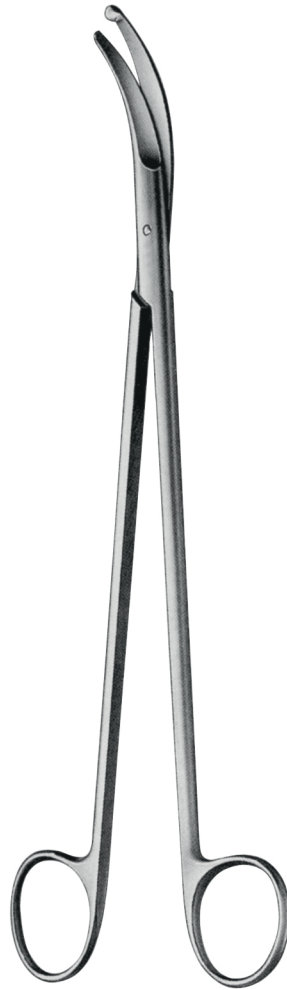

KEIBACK
EC615-00-EC615-02
Parametrium makaslar
1 bleydi küre uclu, yana eğri
Parametrium scissors, curved to side,
with 1 probe pointed blade

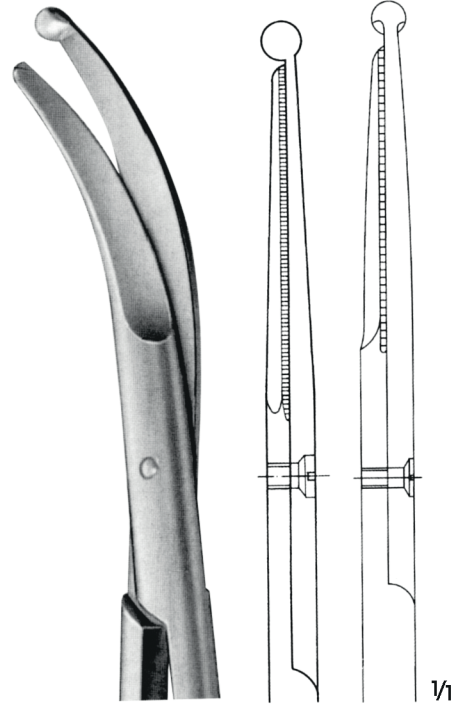

EC615-00
26 cm

EC615-02
35 cm

1/1



BURKE
EG775-00-EG775-02
Parametrium pensler, kısa ağızlı
Parametrium clamps, short jaw part



BURKE
EG776-00-EG776-02
Parametrium pensler, uzun ağızlı
Parametrium clamps, long jaw part

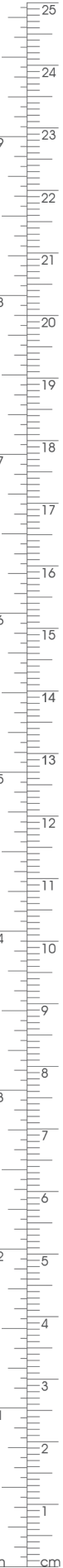

Bükülebilir
Malleable



ASCH
EN585-01
Kaşık/Scoop
20 cm



RANDALL
EN580-02
Biyopsi küreti
Biopsy curette
24 cm

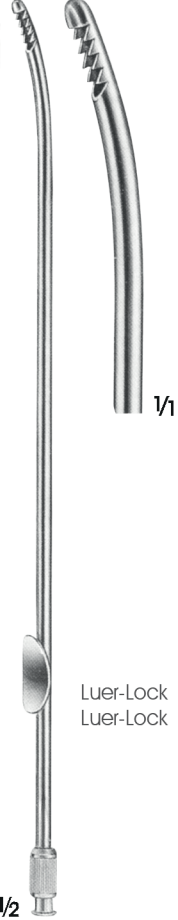

NOVAK-SCHOECKAERT
EN581-02
Biyopsi küreti
Biopsy curette
24 cm



BERLIN
EN595-04
Biyopsi küreti
Biopsy curette
27 cm



MÜNCHEN
EN595-05
Biyopsi küreti
Biopsy curette
27 cm

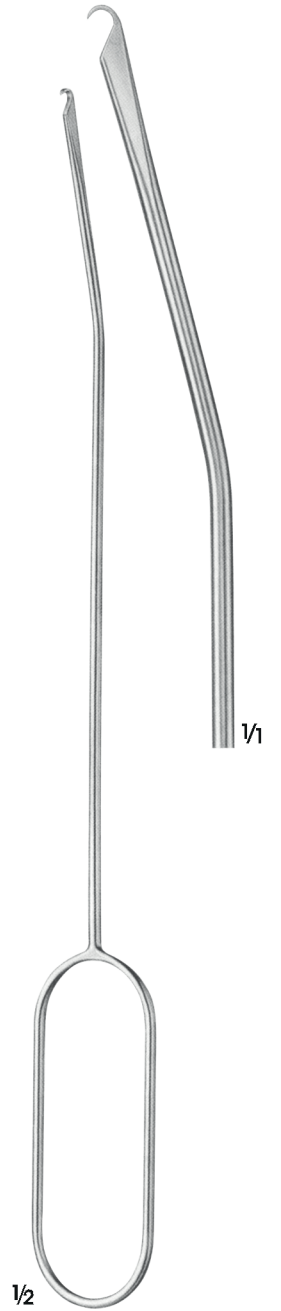

SAUNDERS
EN598-00
Çıkarma huk
Removing hook
32 cm

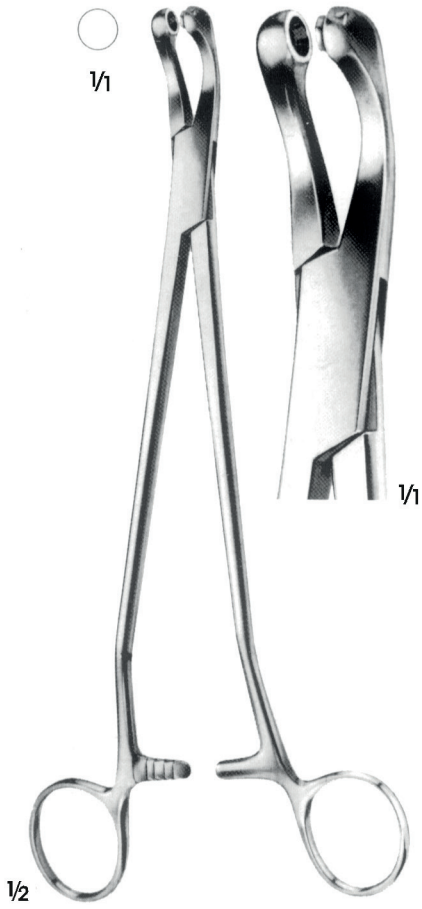

THOMS-GAYLOR
ER700-02
24 cm

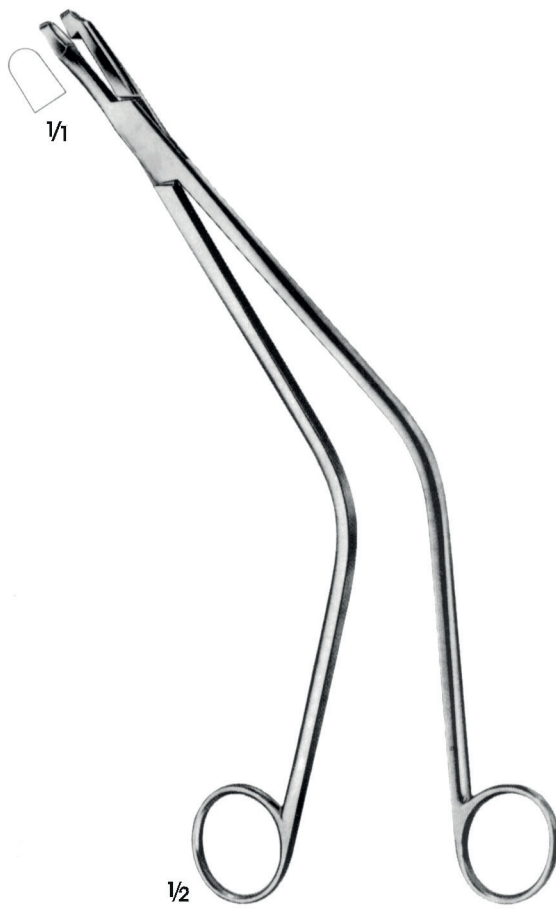

SCHUBERT
ER705-02
26 cm



FAURE
ER710-01
21 cm



FAURE
ER710-03
24 cm



Çengel ağız ile daha güvenilir tutuş sağlar.
Ağız geniş açılabilir.
Düzgün ve uygun kesme sağlar.
Deforme olmamış ezilmemiş parça alınmasına imkan verir.
Travma'ya neden olmaması nedeni ile iyileşme çabuk olur.
More reliable grip on the tissue due to 'hooking' effect.
Wide angle of opening.
Smooth, steady cut.
Specimens are not squashed.
Not painful; self-wound, heals well.



ER715-01



ER715-02



ER717-01
2 mm



ER717-02
2.4 mm

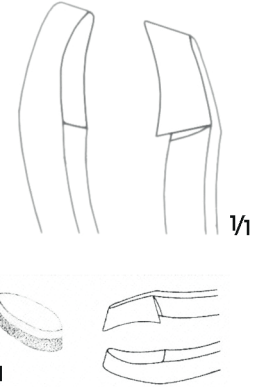

ER718-01
2.4 mm

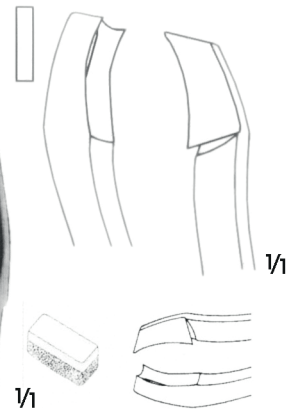

1/2

SCHUMACHER
ER715-01-ER715-02
24 cm

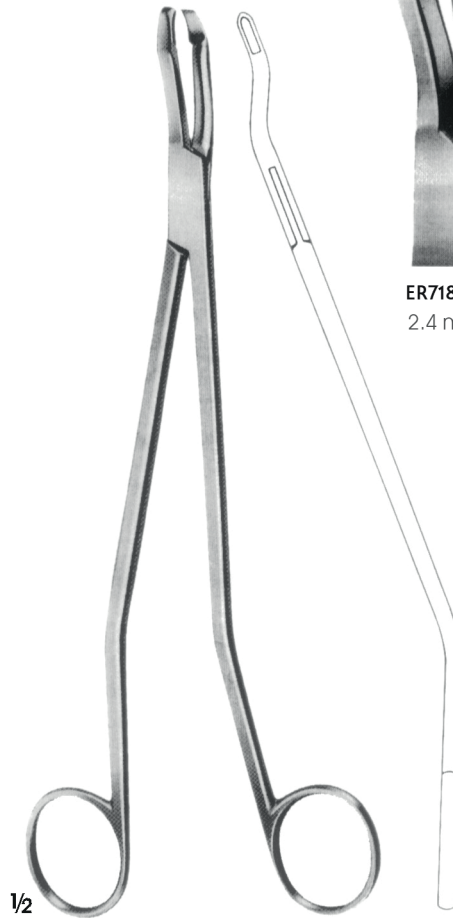

1/2

SEIDL DBP
ER717-01-ER718-02
Bayonet biyopsi pensleri
Bayonet-Shaped biopsy forceps
24 cm

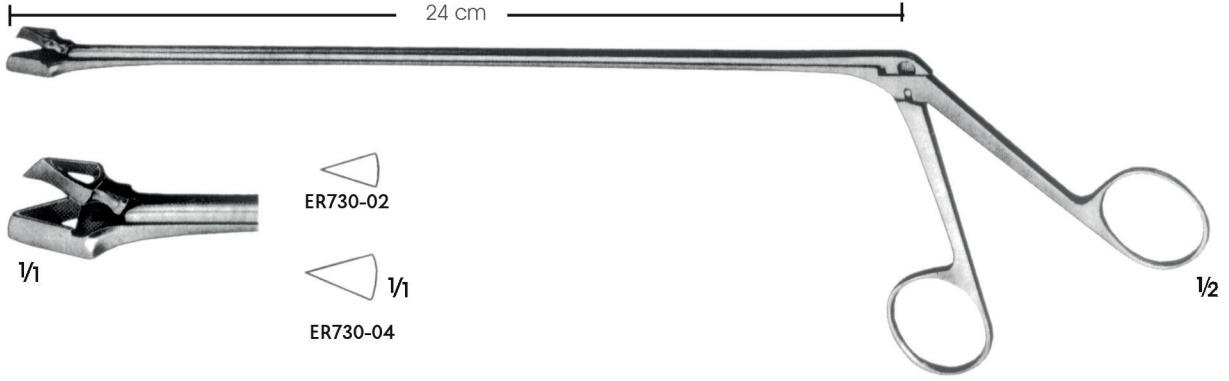

SCHUMACHER
ER730-02-ER730-04
Kolkoskopi için uygun
Suitable for colposcopy
24 cm



EPPENDORF
ER732-02
Kolkoskopi için uygun
Suitable for colposcopy
20 cm



BERGER
ER734-02
21 cm



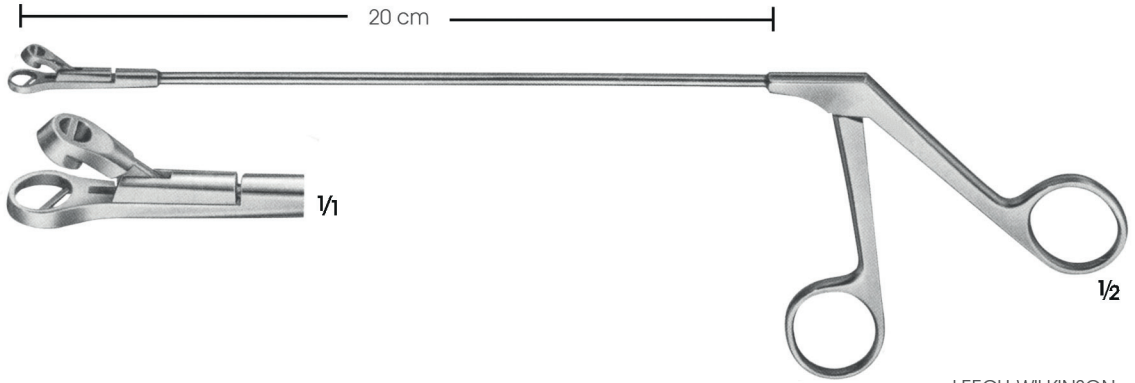

LEECH-WILKINSON
ER733-02

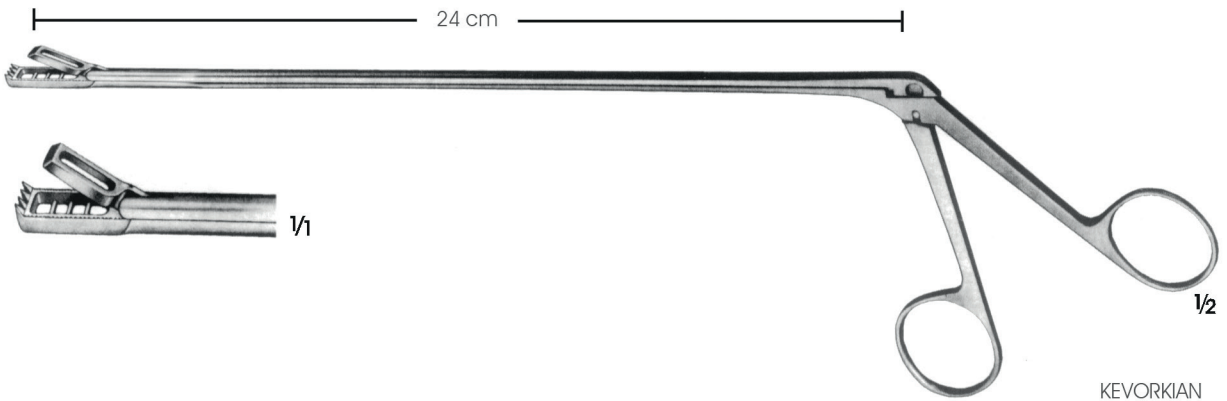

KEVORKIAN
ER740-02
24 cm

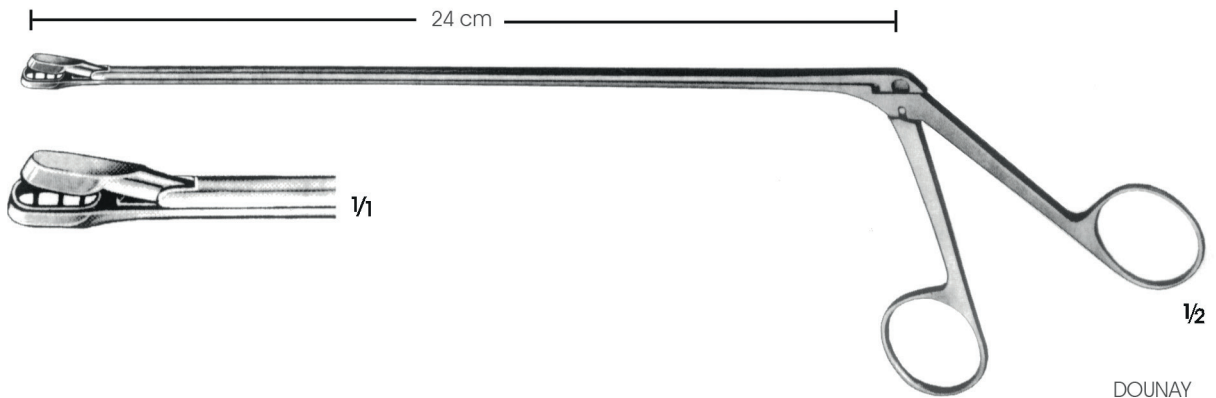

DOUNAY
ER742-02
24 cm

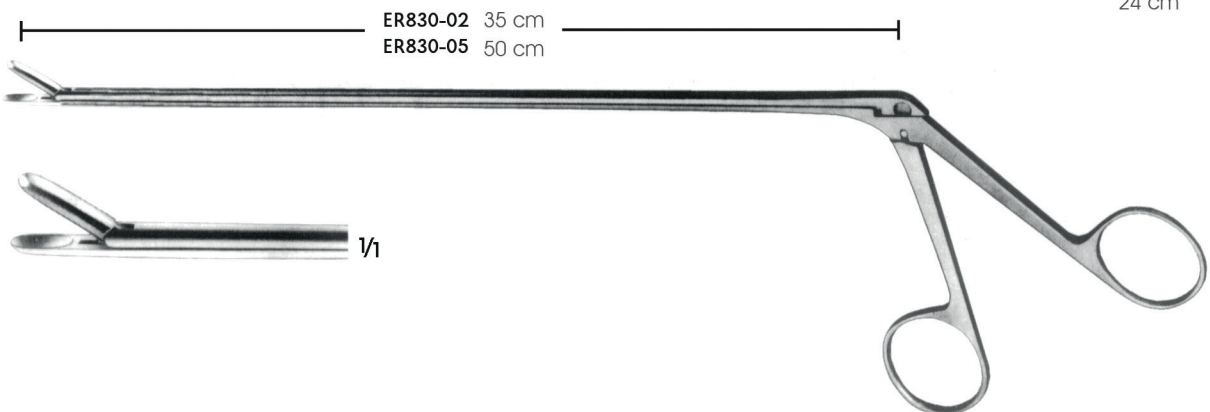

ER830-02-ER830-05

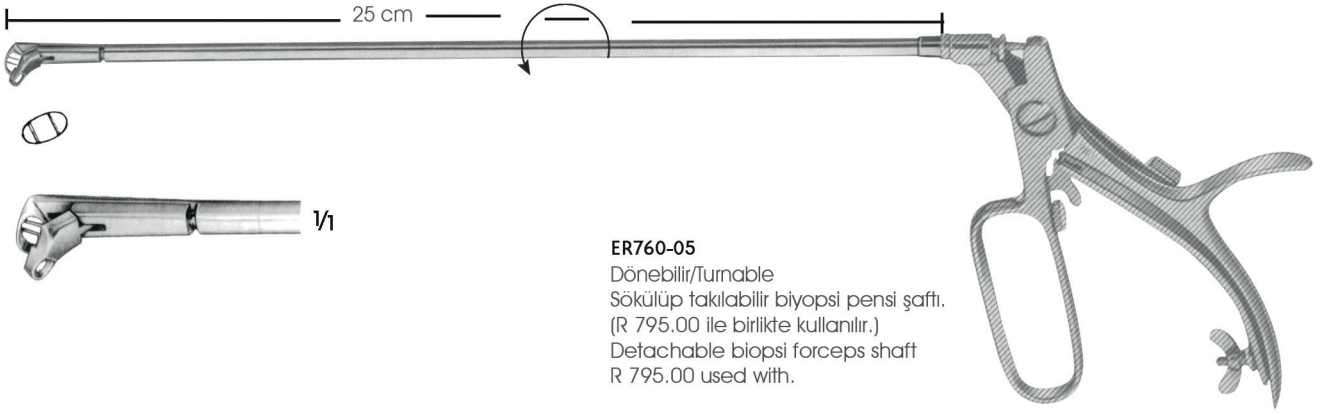
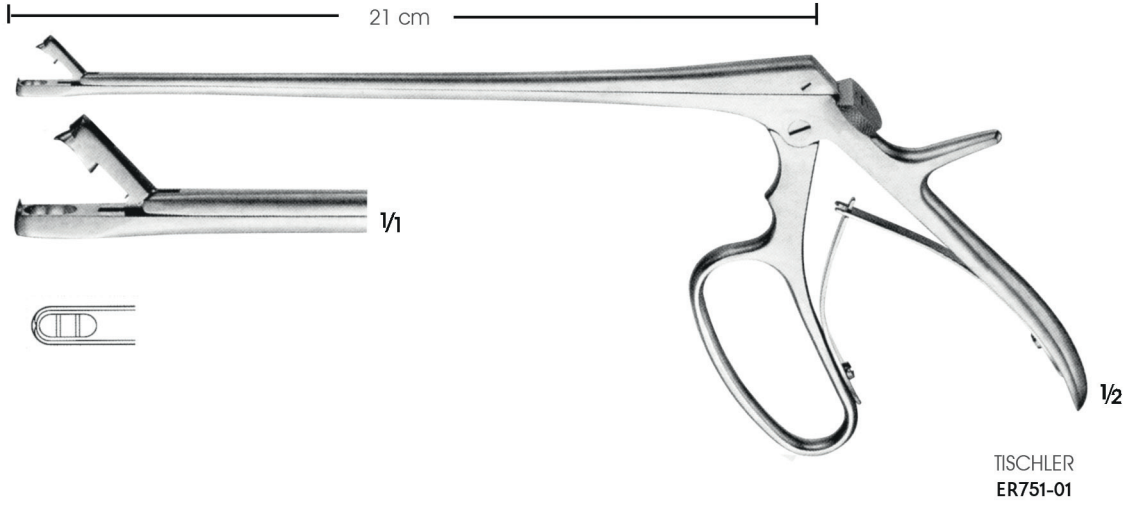

BRÜNNINGS
ER762-01 20 cm
ER762-02 25 cm
Uzatma kanülü/Extension cannula



KRAUSE
ER770-00-ER770-01
Biyopsi uçları/Biopsy tips



SCHUMACHER
ER774-00
Biyopsi ucu/Biopsy tip





1/2
SIMON
EN500-06-EN500-11
24 cm

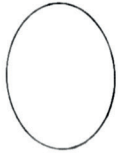

EN500-11
14.5 mm

Fig. 6

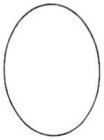

EN500-10
13 mm

Fig. 5

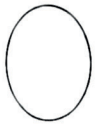

EN500-09
11.5 mm

Fig. 4



EN500-08
10 mm

Fig. 3



EN500-07
8.5 mm

Fig. 2



EN500-06
6.8 mm

Fig. 1



1/2
SCHRÖDER
EN502-06-EN502-11
31 cm

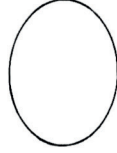

EN502-11
14.5 mm

Fig. 6

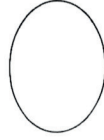

EN502-10
13 mm

Fig. 5

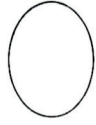

EN502-09
11.5 mm

Fig. 4

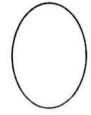

EN502-08
10 mm

Fig. 3



EN502-07
8.5 mm

Fig. 2



EN502-06
6.8 mm

Fig. 1



1/2
GOURDET
EN510-06-EN510-14
Künt/Blunt
28 cm



EN510-14

12 mm



EN510-12

10 mm



EN510-10

8 mm



EN510-08

6 mm



EN510-06

1/1



RECAMIER
EN520-04-EN520-38
 Sivri-Rijid/Sharp-Rigid
EN525-09-EN525-30
 Sivri-Bükülebilir/Sharp-Malleable
EN528-08-EN528-38
 Künt-Rijid/Blunt-Rigid
 30 cm

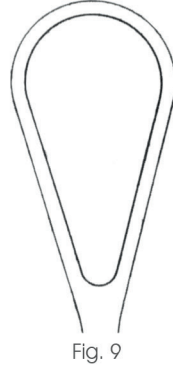

EN520-34
EN528-34
 21.5 mm

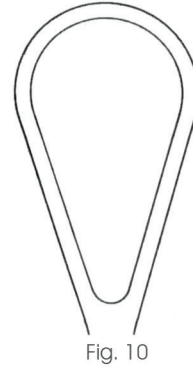

EN520-38
EN528-38
 23.5 mm



EN520-27
EN525-27
EN528-27
 18 mm



EN520-30
EN525-30
EN528-30
 19.5 mm



EN520-21
EN525-21
EN528-21
 15 mm



EN520-24
EN525-24
EN528-24
 16.5 mm



EN520-15
EN525-15
EN528-15
 12 mm



EN520-19
EN525-19
EN528-19
 14 mm



EN520-09
EN525-09
EN528-09
 8.5 mm



EN520-12
EN525-12
EN528-12
 10.5 mm



EN520-04
 4.5 mm



EN520-08
EN528-08
 7.5 mm



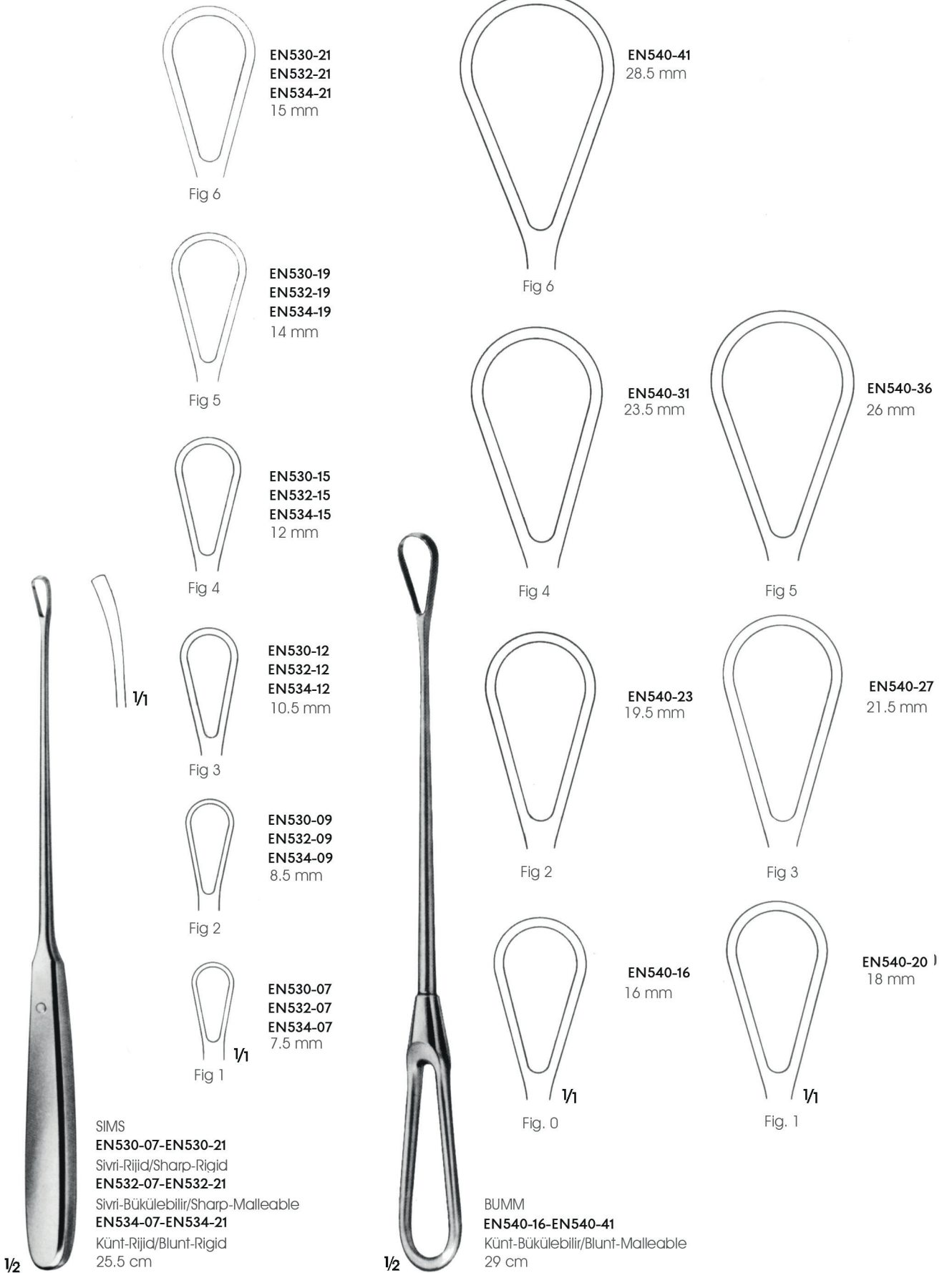



RECAMIER
EN550-34-EN550-44
Künt-Rijid/Blunt-Rigid
36 cm

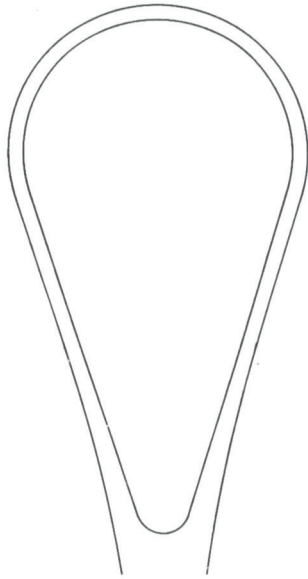

Fig. 2

EN550-44
39.5 mm

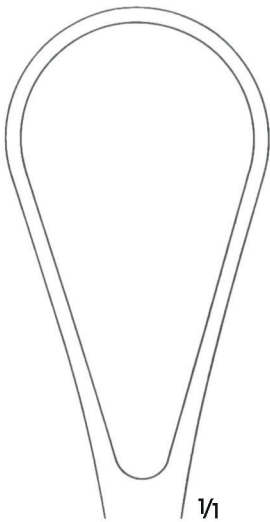

Fig. 1

EN550-34
34.5 mm



BUMM
EN552-24-EN552-35
Sivri-bükülebilir/Sharp-malleable
EN554-24-EN554-35
Künt-bükülebilir/Blunt-malleable
31 cm

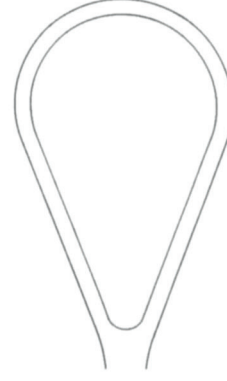

Fig. 3

EN552-35
EN554-35
28.5 mm

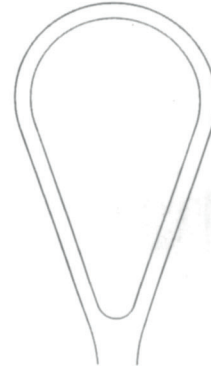

Fig. 2

EN554-30
26 mm



Fig. 1

EN552-24
EN554-24
23.5 mm



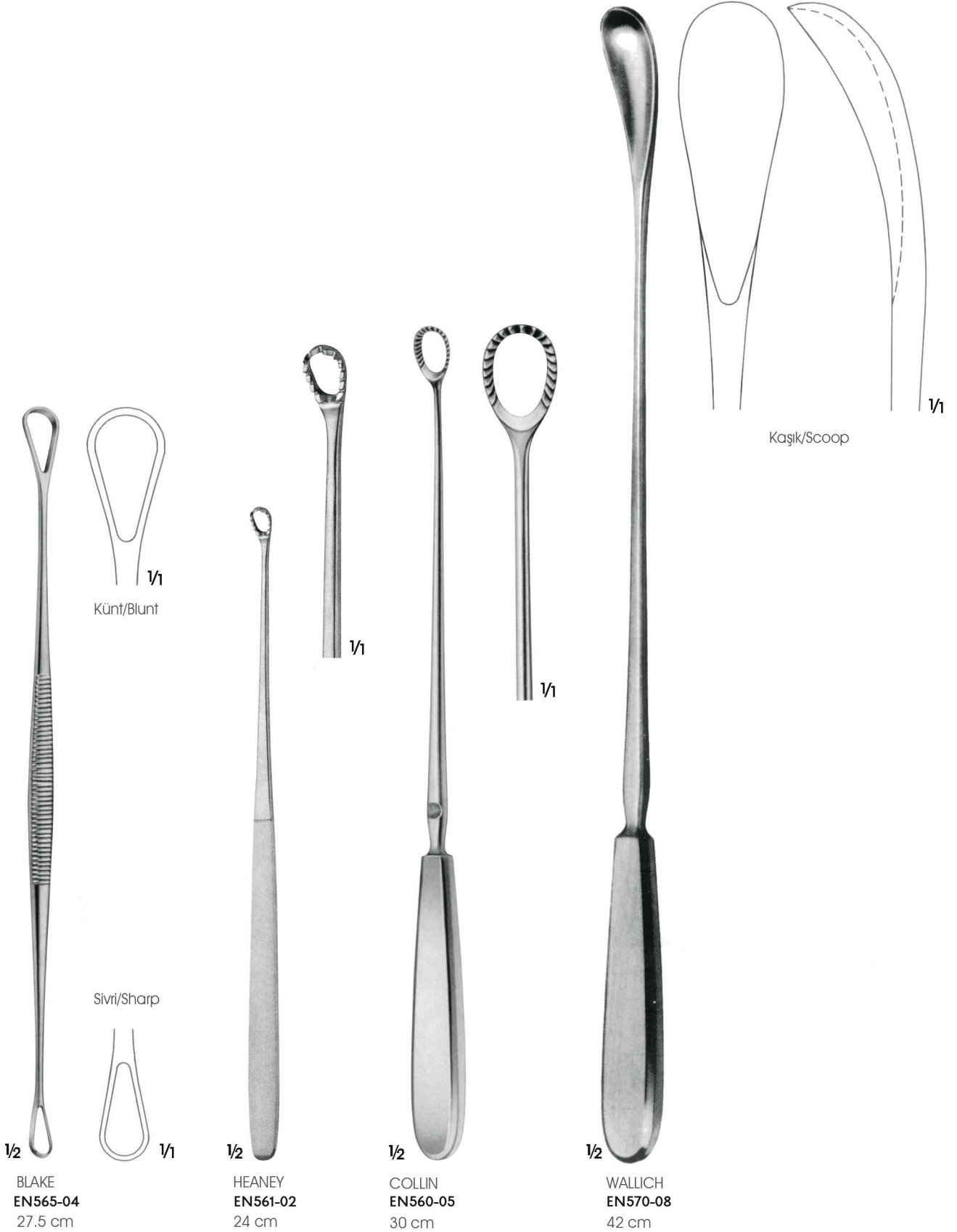



EJ451-00 Ø 4 mm
EJ451-01 Ø 6 mm
EJ451-02 Ø 8 mm
EJ451-03 Ø 10 mm
EJ451-04 Ø 12 mm
EJ451-05 Ø 14 mm

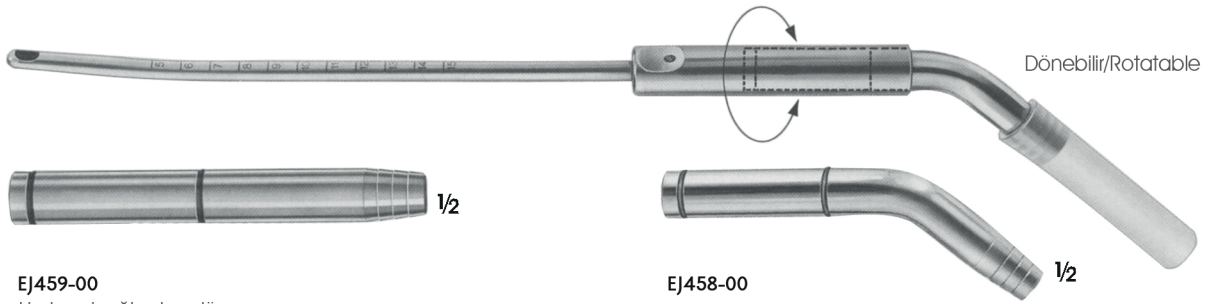

EJ459-00
Hortum bağlantısı, düz
Hose connection, straight
iç çap Ø 11 mm
inside diam Ø 11 mm

EJ458-00
iç çap Ø 11 mm
inside diam Ø 11 mm

Dönebilir/Rotatable

Çalışması :

Arzu edilen (ihtiyaç duyulan) vakum miktarı ayarlama vidası ile sürekli olarak istenilen değere ayarlanabilir. Vakum oluştuğunda bu vakumun emme kafalarına uygulanması için hızlı-kesme düğmesinin sağa veya sola basılması ile sağlanır. Ayarlanan vakum değeri vakum ayar vidası ile değiştirilebilir. Emme işleminin aniden durdurulması isteniyorsa hızlı-kesme düğmesi kapatılır. Böylece emme kafasına gelen vakum kesilmiş ve emme kavanozuna akış durdurulmuş olur.

Function:

The vacuum required can be constantly preset by the adjusting screw. This vacuum exists then up to the closed quick-shutter, thus the vacuum in the suction head is pressed from the left to the right, the nounted suction head is immediately put under the preset vacuum. In case the preset vacuum has to be changed, this can be done with the adjusting screw. For immediate removal of the suction head simply close the quick-shutter, thus the vacuum in the suction head is eliminated at once whereas the vacuum in the suction jar remains unchanged.



EJ480-03 40 mm
EJ480-04 50 mm
EJ480-05 60 mm
Çekme kolu ile birlikte
With traction handle
134°C Otoklav edilebilir
134°C Autoclavable



EN480-10
El vanası ve bağlantı borusu
20 cm uzunluğunda bağlantı borusu
Hand valve with connection hose
20 cm long connection hose



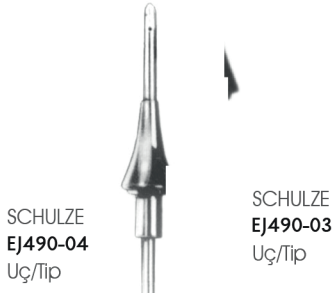

SCHULZE
EJ490-04
Uç/Tip

SCHULZE
EJ490-03
Uç/Tip

EJ490-02
Uç/Tip



SCHULZE
EJ490-01
37.5 cm

1/2

SCHULZE
EJ490-00 Komple/Complete
J 490.01
J 490.02-J 490.03-J 490.04
Salpingografi için uterin kanül
Salpingography uterine cannula



1/1

EJ496-02
Büyük/Large
Ø 16 x 30 mm



1/1

EJ496-01
Orta/Medium
Ø 13 x 30 mm



1/1

EJ496-00
Küçük/Small
Ø 10 x 25 mm

1/2

LEECH-WILKINSON
EJ496-00-EJ496-02
Uterin kanül
Uterine cannula
26.5 cm



1/2

EJ952-00
Rahim kanülü, büyük ve küçük
2 adet değiştirilebilir konik uçları ile
Uterine cannula with spring
connector, self-retaining complete with
2 interchangeable cones large and small
25 cm

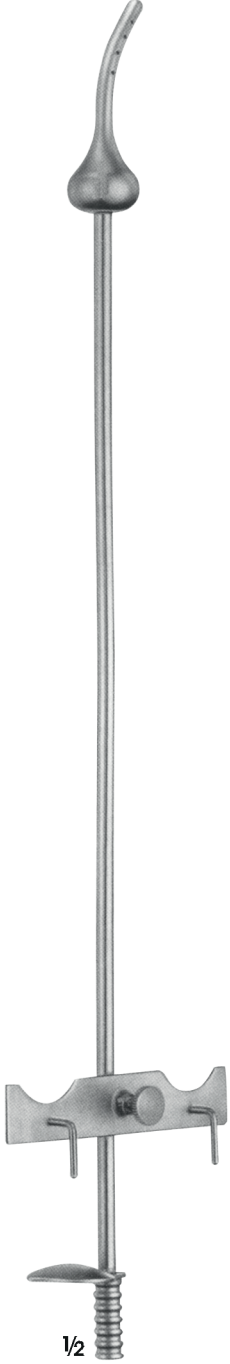

**SPACKMAN
EJ493-00**
Ayarlanabilir plaka ile
vulslum pensi
With adjustable plate for
vulslum forceps
36 cm



**BEHRMAN
EJ495-00**
Konik ucu çıkartılabilir
uterin kanülü
Uterine cannula with
detachable cone
30.5 cm

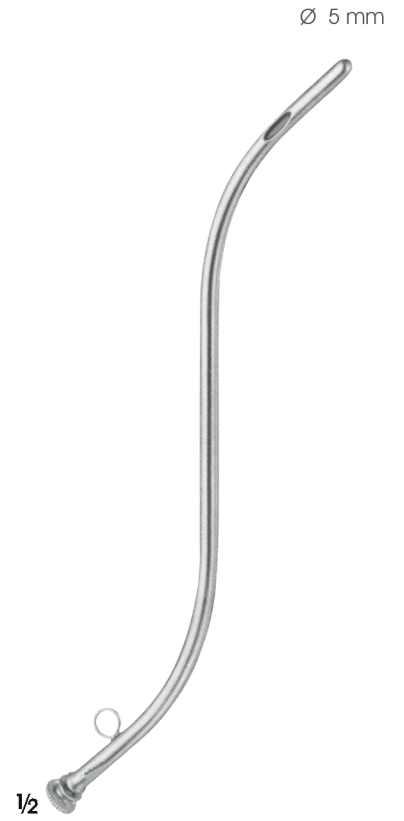

**ROTUNDA
EJ497-00**
İrigasyon kanül
Irrigation cannula
20 cm



Özel Set transvajinal paraservikal ve
pupendus anestezi Enjeksiyonu için
Special set for transvaginal injection for
paracervical anestheisa as well as
anestheisa of the pudendus



EJ133-00
Kılavuz klifi
Guide sheath
17.5 cm

EJ134-00
Enjeksiyon iğnesi
Injection needle
Luer-lock
1,0 x 18.5 cm



DE LEE
EA610-01
Pelvimetre santimetre ve inç ölçülü
Pelvimeter centimeters and inches
measured



MARTIN
EA620-01
Santimetre ölçülü
Graduated in centimeters



**BEACHAM
EK295-02**
Amniyotom/Amniotome
24 cm



EB610-01
Poş Açıcı/Pouch opener
44 cm



**HERFF
EB387-02**
Zar delici pens
Membrane puncturing forceps
25.5 cm



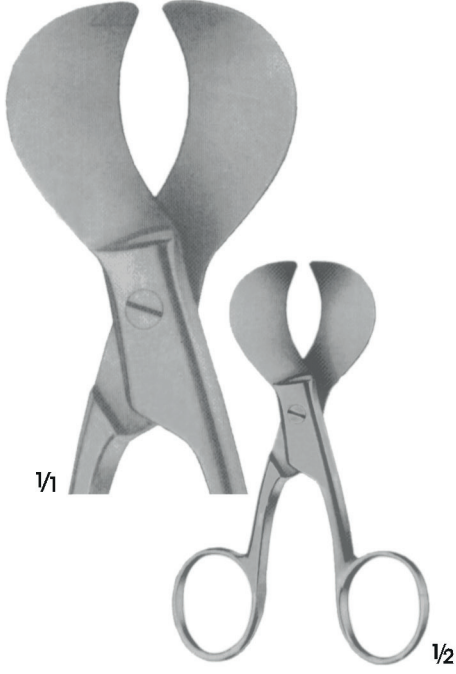

EC600-00
Göbek bağı makası
Umbilical cord scissors
10.5 cm



SCHUMACHER
EC602-00
Göbek bağı makası
Umbilical cord scissor
15.5 cm

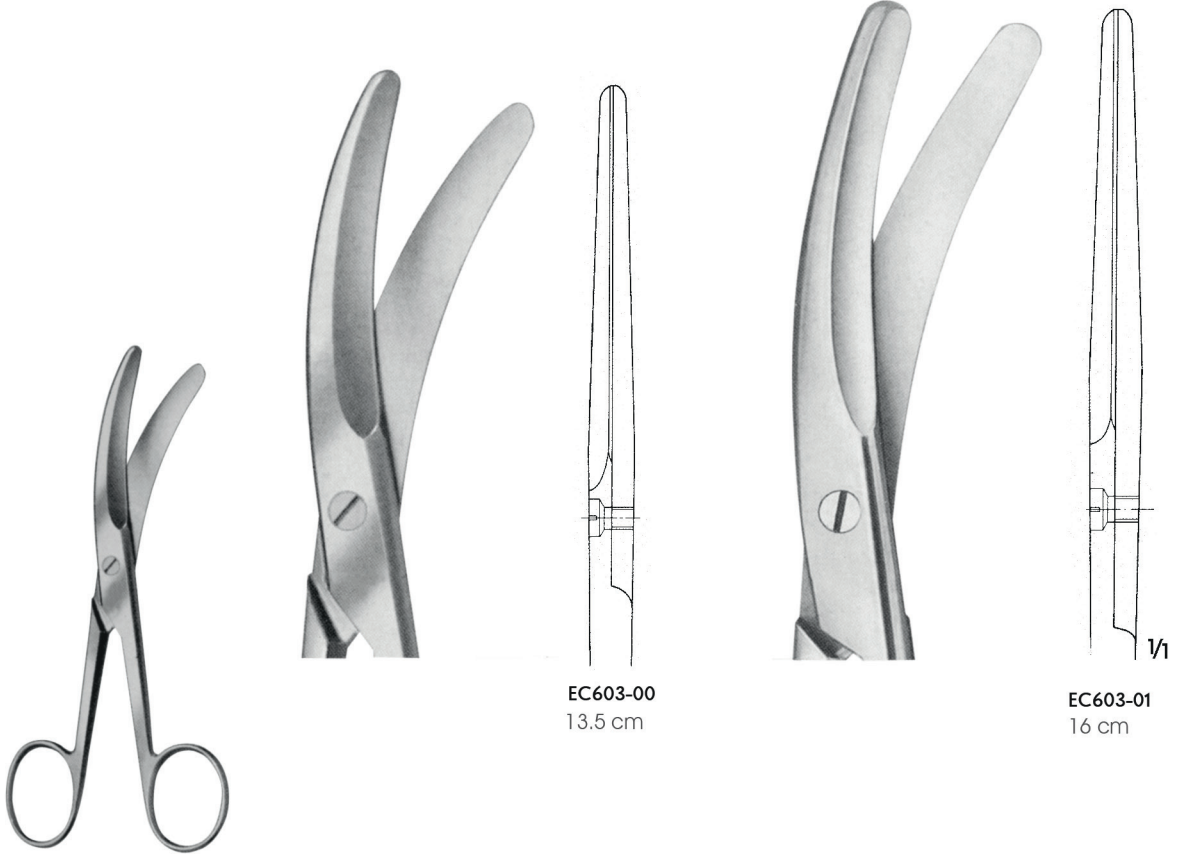

EC603-00
13.5 cm

EC603-01
16 cm

EC603-00-EC603-01
Göbek bağı makaları
Umbilical cord scissors



BRAUN-STADLER
EC604-00-EC604-01
Epizyotomi makasları
Episiotomy scissors



EC604-00
14.5 cm



EC604-01
20 cm



EC610-00
Epizyotomi makas
Episiotomy scissors
24 cm

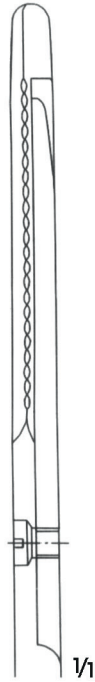

1/1



EJ085-00
Göbek dilatörü
Umbilical dilator
9.5 cm



COLLIN
ET425-00
Göbek kordonu klempe
Umbilical cord clamp
8.5 cm





1/3

SIMPSON
EE558-02
Sezeryan ameliyatı için
For caesarean section
23.5 cm



1/3

SIMPSON-BRAUN
EE555-00
30.5 cm



1/3

SIMPSON-BRAUN
EE556-00
35 cm



1/3

NAGELE
EE557-02
35.5 cm



1/3

WRIGLEY
EE559-02
Sezeryan ameliyatı için
For caesarean section
25 cm



1/3

SELHEIM
EE573-02
Obstetrik levye
Obstetric lever
30 cm



1/3

KIELLAND
EE565-02
42 cm



1/3

PIPER
EE567-02
44.5 cm





1/3

TARNIER
EE578-04
Çekme çubuklu
With traction rod
40 cm



1/3

BARNES-NEVILLE
EE579-04
Çekme sapları
With traction handle
43.5 cm

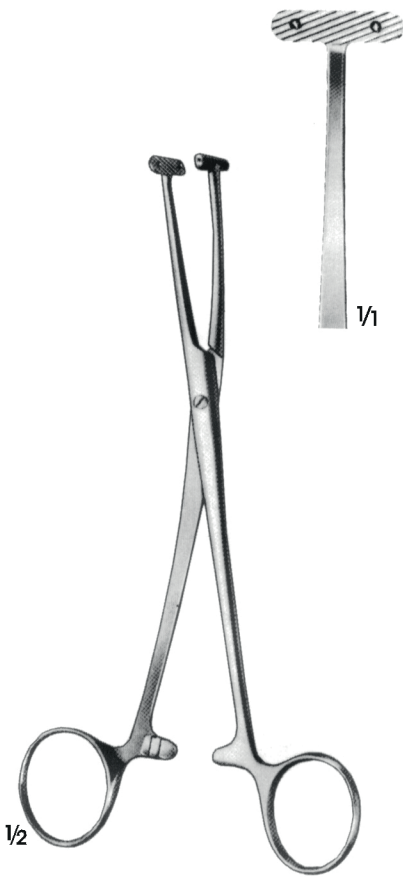

**WILLETT
EE590-01**
Kafa derisi tutucu pens
Scalp flap forceps
18.5 cm

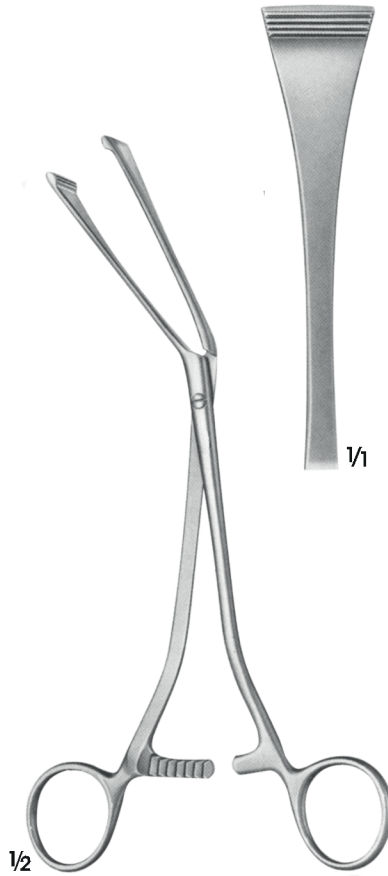

**GREEN-ARMYTAGE
EE593-01**
Sezeryan hemostatik pens, açılı
Caesarean hemostatic forceps,
angled
19.5 cm

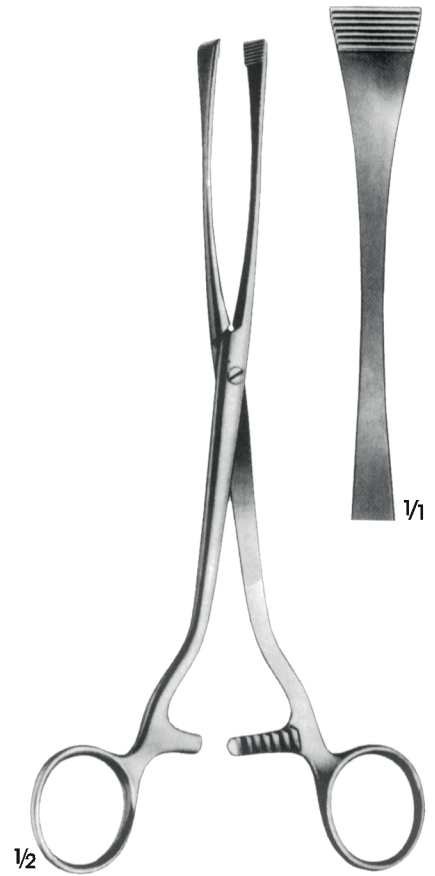

**GREEN-ARMYTAGE
EE594-02**
Sezeryan hemostatik pens düz
Caesarean hemostatic forceps,
straight
22 cm



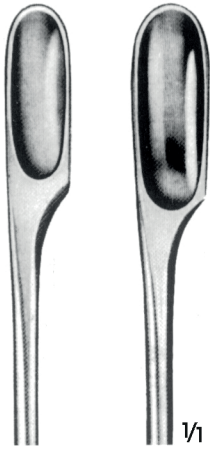

EE700-01 EE700-02 1/1



EE702-01 EE702-02 EE702-03 1/1



EE705-01 EE705-02 1/1

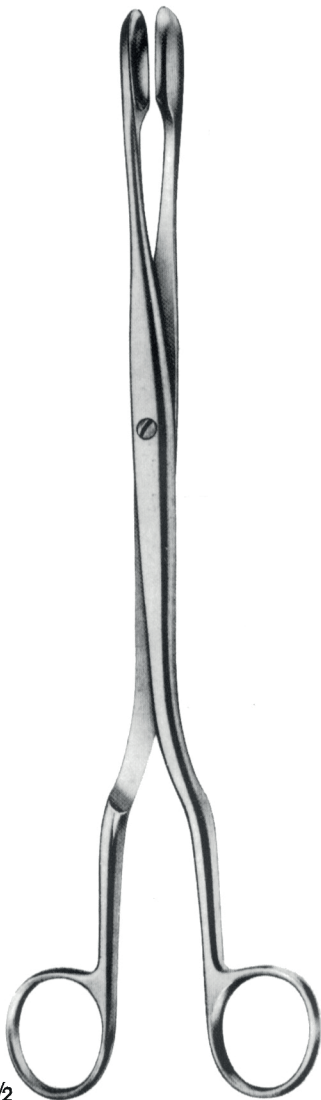

1/2

WINTER
EE700-01-EE700-02
29 cm

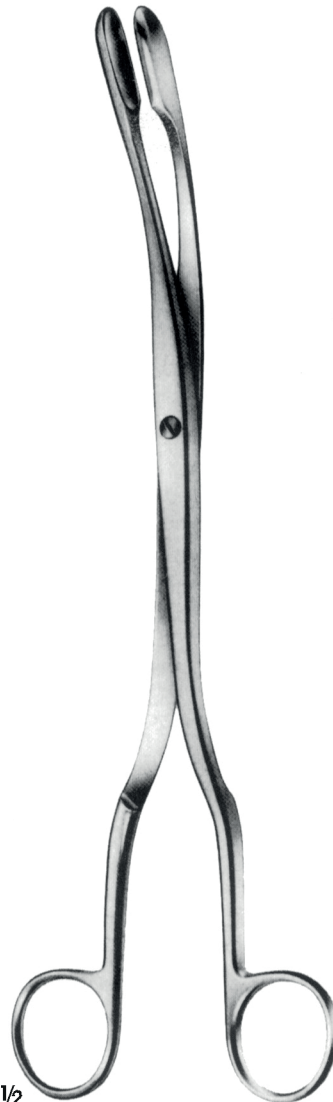

1/2

WINTER
EE702-01-EE702-03
29 cm



1/2

WINTER
EE705-01-EE705-02
Kilitli/With ratchet
29 cm

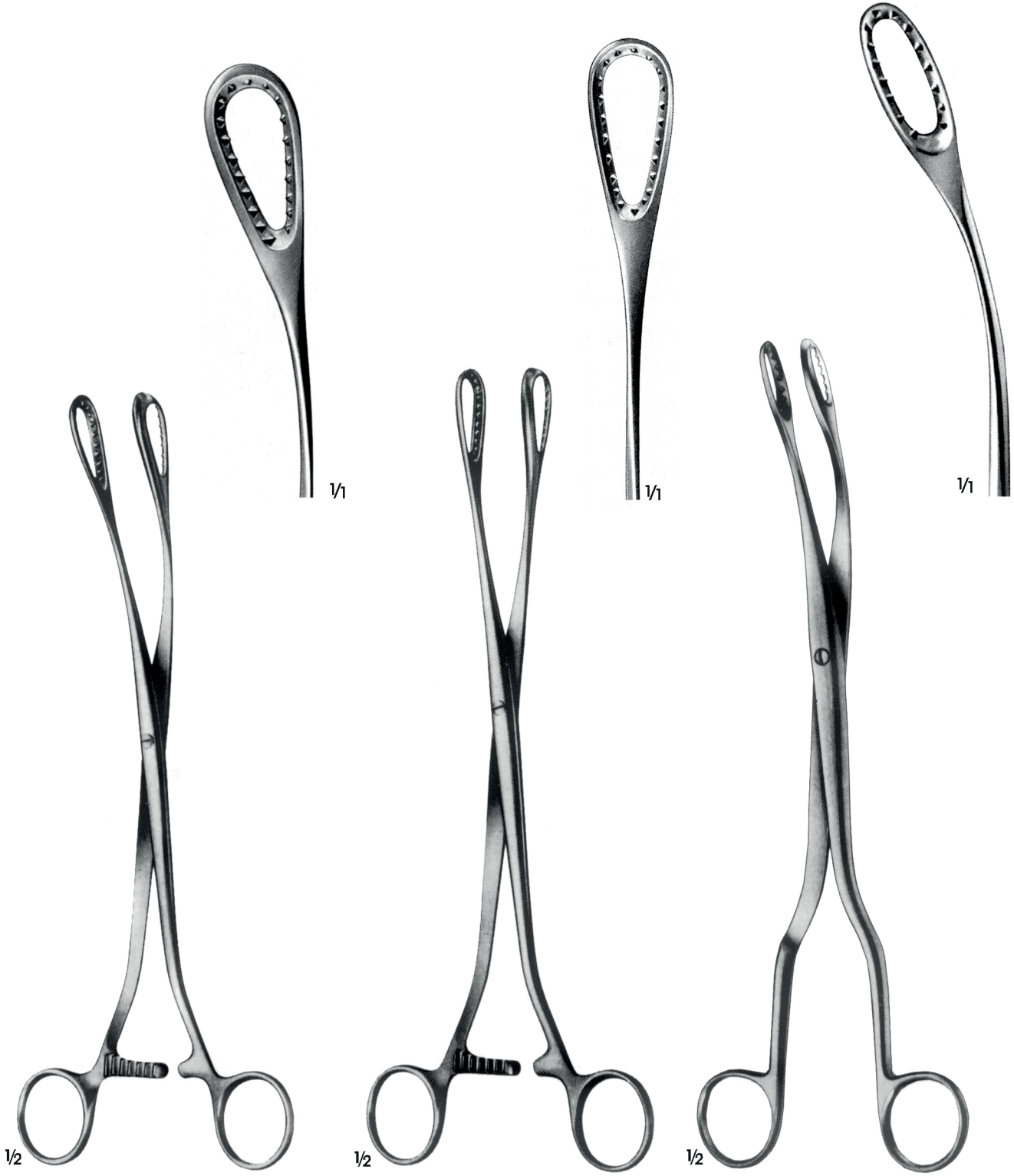

1/2

SAENGER
EE720-02
26.5 cm

1/1

1/2

SAENGER
EE721-02
27.5 cm

1/1

1/2

SAENGER
EE722-02
28.5 cm

1/1





1/3

SMELLIE
ET430-01
27 cm

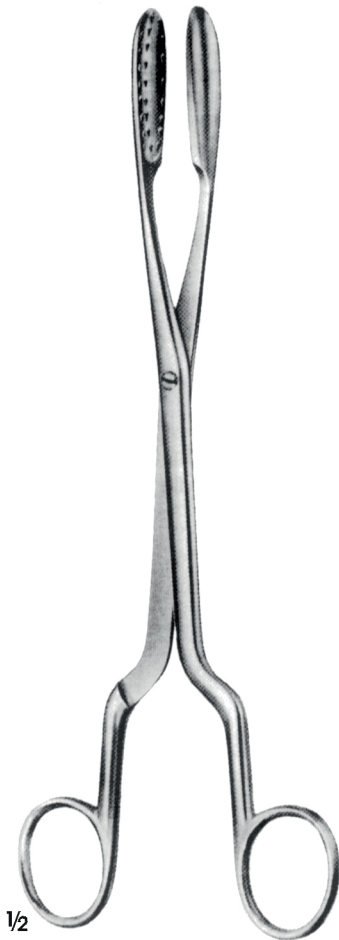

1/2

LEWKOWITZ
EE730-02-EE731-02
24.5 cm



1/2

BOER
EE735-02
29 cm



1/1



1/1

