

EGC

Genel Cerrahi
General Surgery

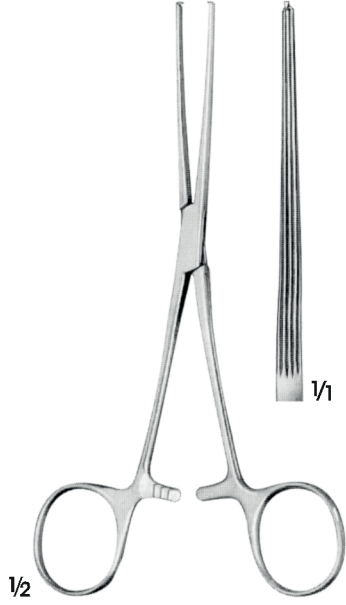



ALLEN
EG330-00
15.5 cm

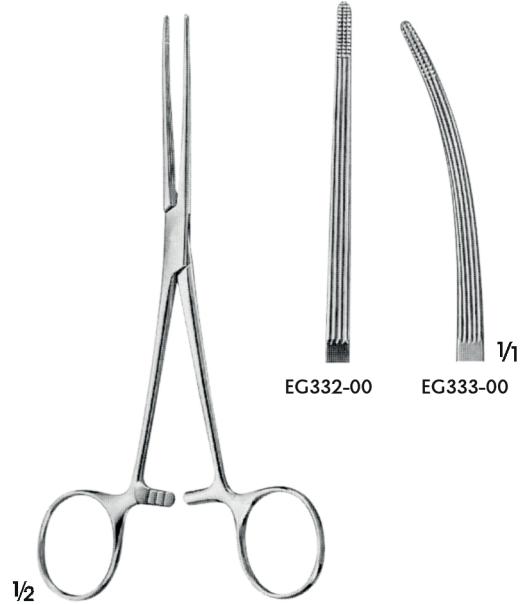

BAINBRIDGE
EG332-00-EG333-00
15.5 cm



DOYEN
EG335-00-EG336-00
Elastik/Elastic
16.5 cm

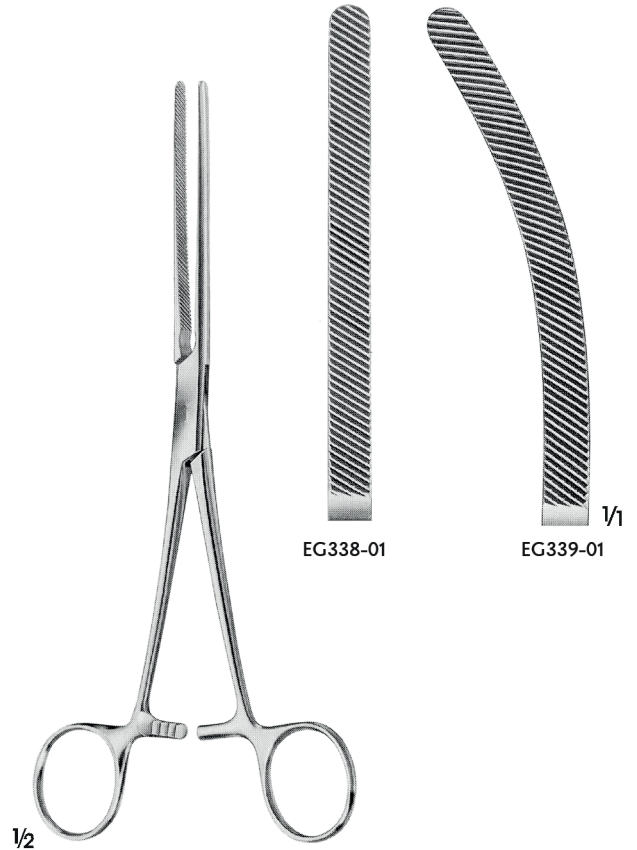

HARTMANN
EG338-01-EG339-01
Yumuşak ve elastik
Soft and elastic
20 cm



BABY-KOCHER
EG345-00-EG346-00
Çocuklar için/For children
Çok elastik/Very elastic
13 cm



BABY-KOCHER
EH350-00-EH351-00
Çocuklar için/For children
Yumuşak ve elastik/ Soft and elastic
13 cm

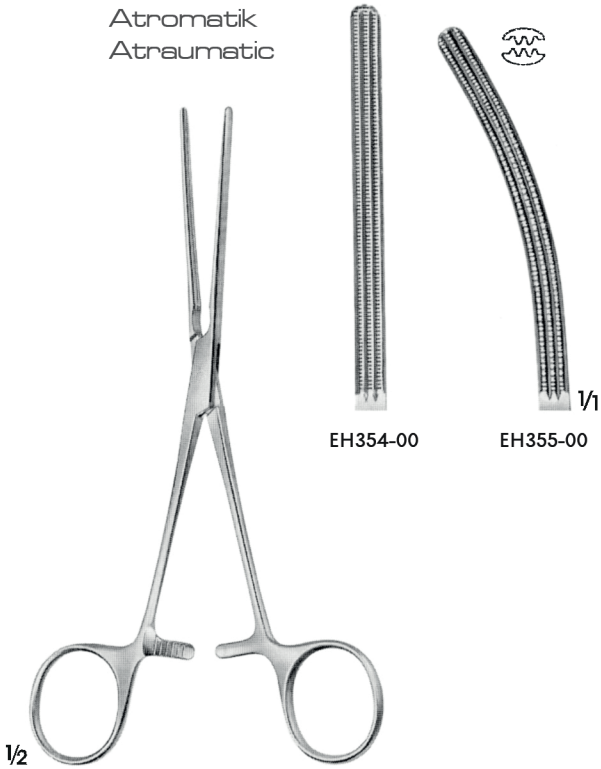

DOYEN
EH354-00-EH355-00
Yumuşak ve elastik
Soft and elastic
17 cm

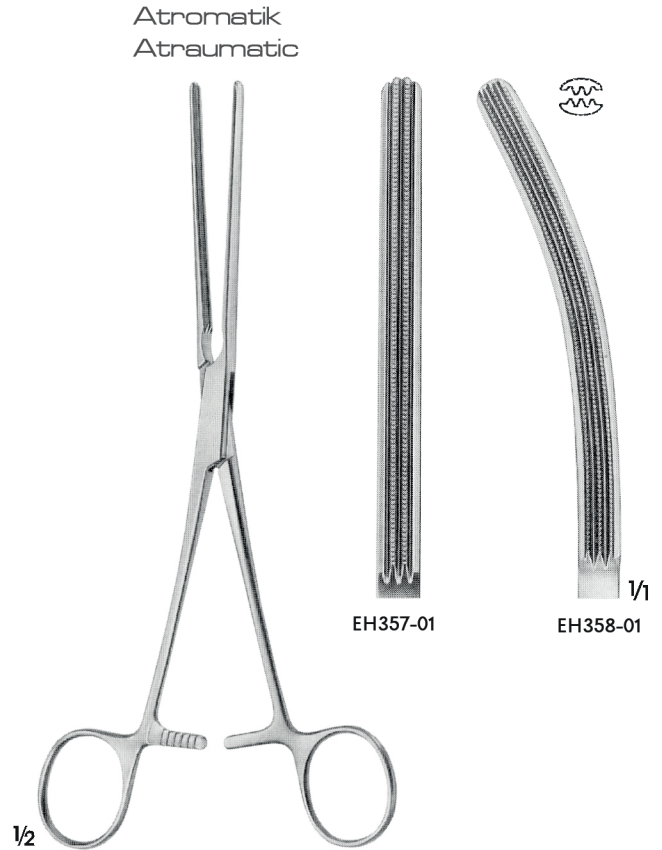

HARTMANN
EH357-01-EH358-01
Yumuşak ve elastik
Soft and elastic
20 cm





KOCHER
EG356-01-EG356-02
EG357-01-EG357-02
Yumuşak ve elastik
Soft and elastic

DOYEN
EG358-01-EG359-01
Yumuşak ve elastik
Soft and elastic
24 cm

Atromatik
Atraumatic

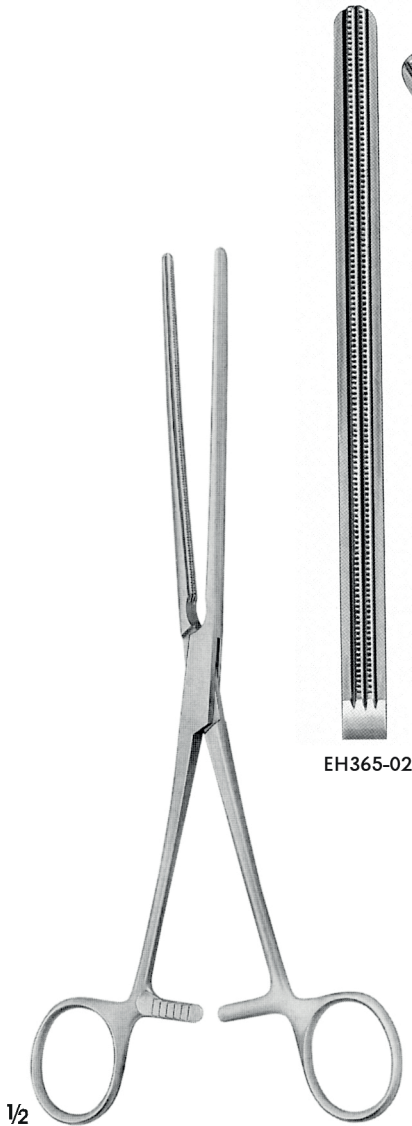

EH365-02

EH366-02

1/2

DOYEN
EH365-02-EH366-02
Yumuşak ve elastik
Soft and elastic
23 cm

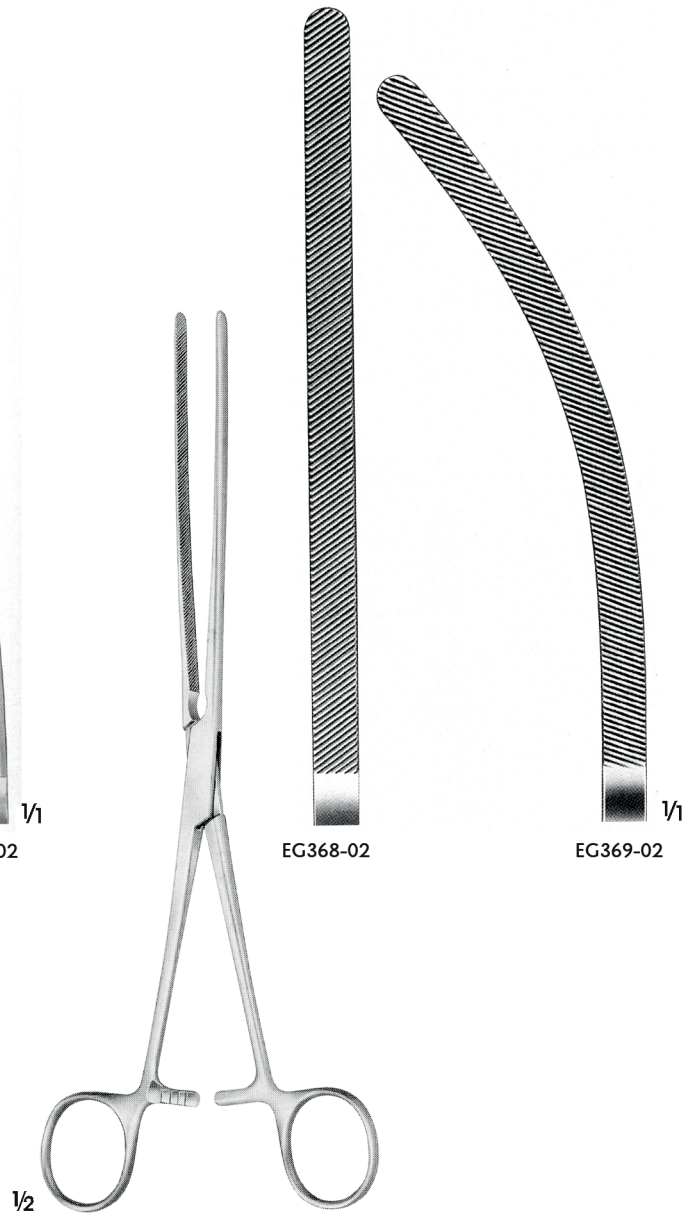

EG368-02

EG369-02

1/2

DOYEN
EG368-02-EG369-02
Yumuşak ve elastik
Soft and elastic
23.5 cm

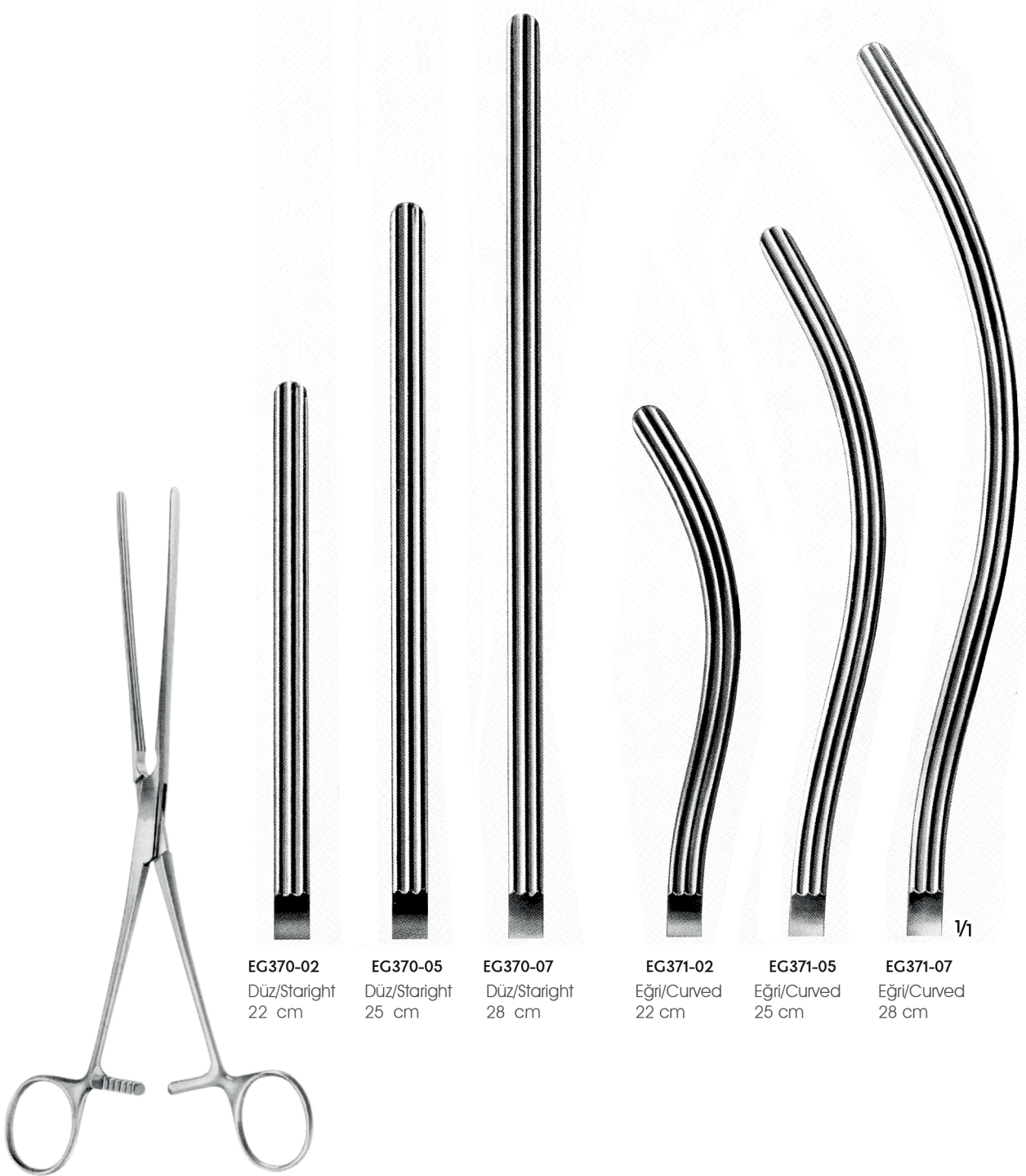

EG370-02
Düz/Straight
22 cm

EG370-05
Düz/Straight
25 cm

EG370-07
Düz/Straight
28 cm

EG371-02
Eğri/Curved
22 cm

EG371-05
Eğri/Curved
25 cm

EG371-07
Eğri/Curved
28 cm

KOCHER
EG370-02-EG370-07
EG371-02-EG371-07
Yumuşak ve elastik
Soft and elastic



KOCHER
EG360-02-EG360-07
EG361-02-EG361-07
Yumuşak ve elastik
Soft and elastic

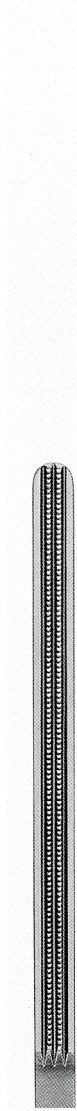

EG360-02
Düz/Straight
22 cm

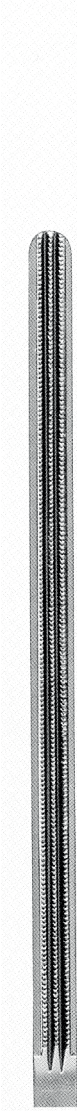

EG360-05
Düz/Straight
25 cm



EG360-07
Düz/Straight
28 cm



EG361-02
Eğri/Curved
22 cm

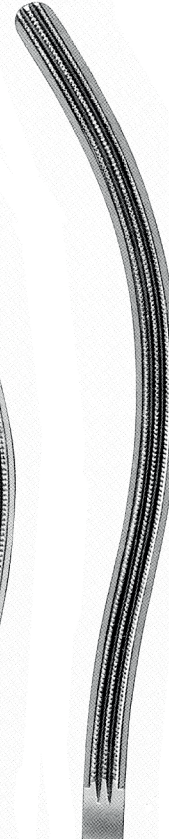

EG361-05
Eğri/Curved
25 cm

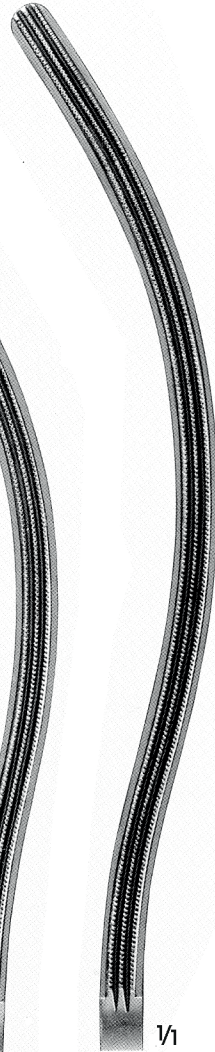

EG361-07
Eğri/Curved
28 cm



1/1

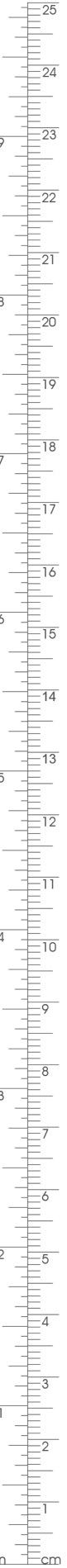

Atromatik
Atraumatic

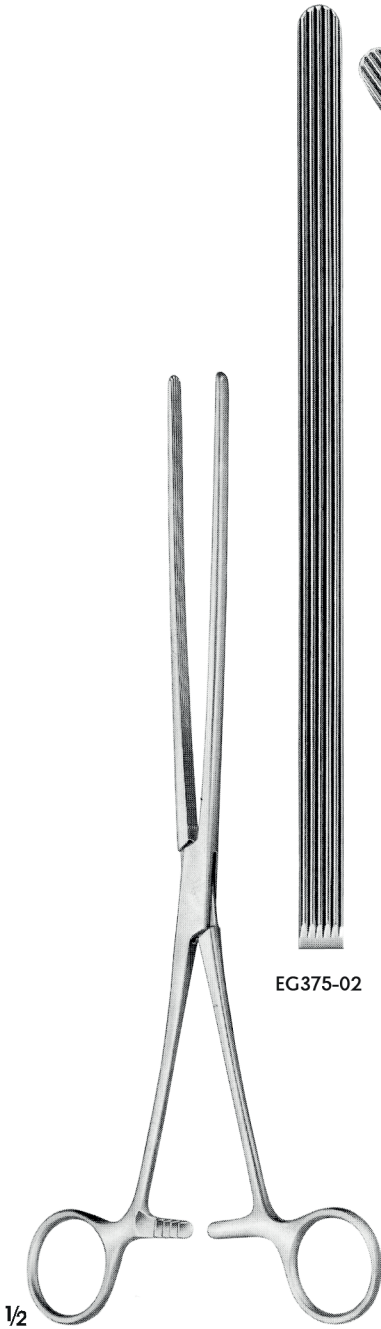

EG375-02

EG376-02

1/1

1/2

MAYO-ROBSON
EG375-02-EG376-02
Sert ve elastik
Hard and elastic
25 cm

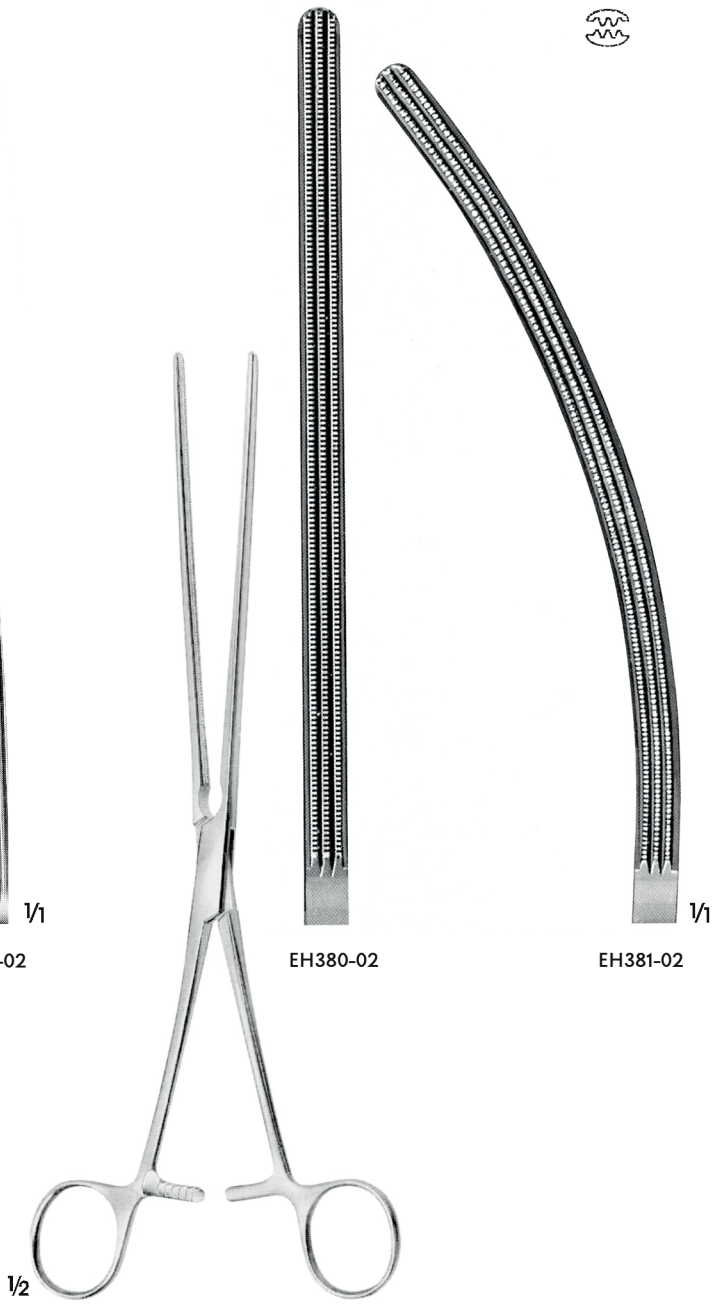

EH380-02

EH381-02

1/1

MAYO-ROBSON
EH380-02-EH381-02
25 cm

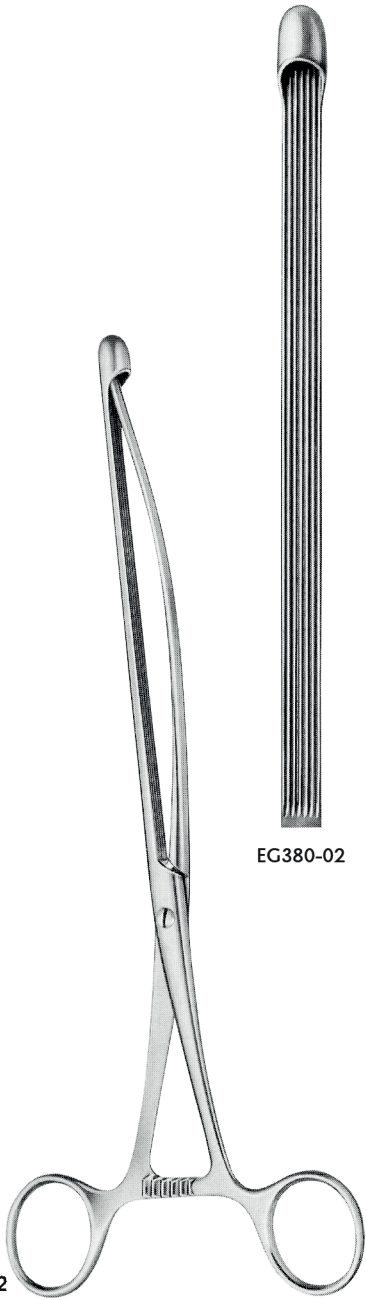

EG380-02

EG381-02

1/2

NUSSBAUM
EG380-02-EG381-02
Yumuşak ve elastik
Soft and elastic
25 cm

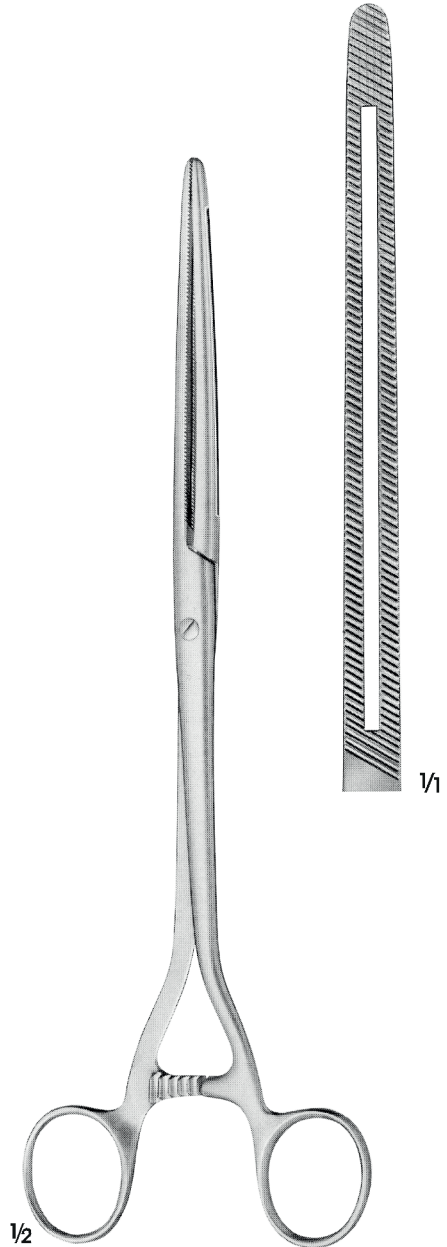

MAYNIHAN
EG385-02
28 cm

1/2

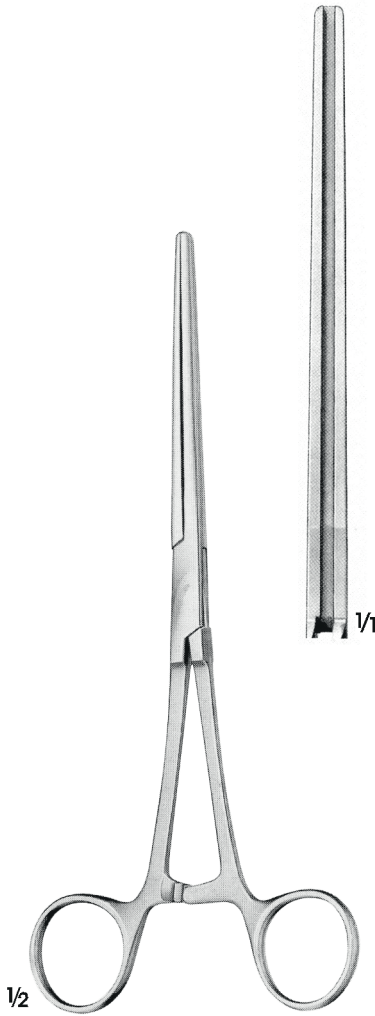

SCHOEMAKER
EG 3822000
Kolektomi klempi
Colectomy clamp
20 cm

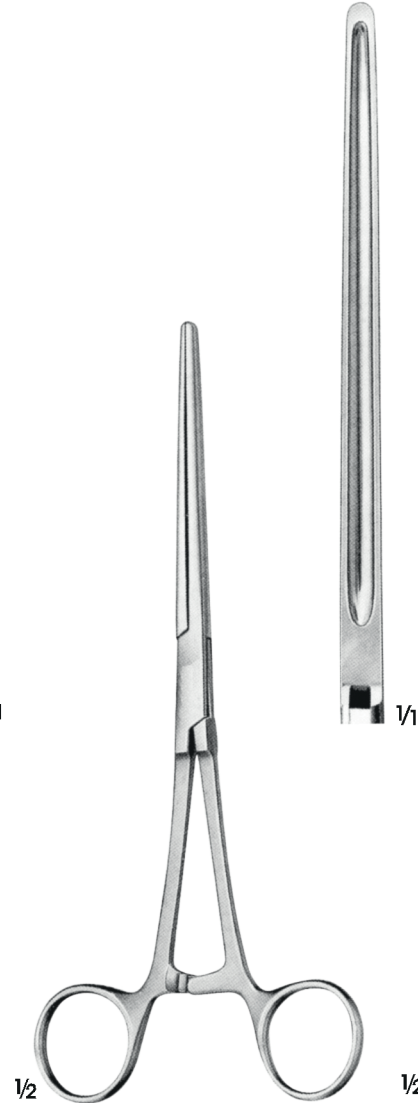

LANG-STEVENSON
EG 3833000
Bağırsak klempi
Intestinal clamp
20 cm



SCUDDER
FH385-02
Mide klempi
Stomach clamp
33 cm



PAYR
EG580-00
Çocuklar için bağırsak klempli
Intestinal clamp light pattern,
for children
18 cm

PAYR
EG580-02
20 cm

PAYR
EG580-04
27.5 cm

PAYR
EG580-06
Pilor Klempli
Pylorus clamp
31.5 cm



LANE
EG480-02
31 cm

LANE
EG482-02
31 cm



HABERER
EG484-02
36 cm





BENSON
EG398-00
Pilor ayırıcı
Pylorus spreader
15.5 cm



KLEINSCHMIDT
EG350-00
Apendektomi klempli
Appendectomy clamp
13 cm

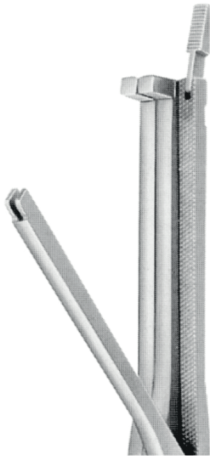

DE MARTEL-WOLFSON
EG585-00 10 cm
EG585-01 12 cm
Anastomoz klempli, 3'lü set
Anastomosis clamps,
set of 3



EG587-23 22.5 cm
Klempli tutucusu
Clamp holder
(G 585.00-G 585.01)



Sert Klempli tutucu
Clamp holder with set of clamps

EG587-08 8 cm
Klempli tutucusu
Clamp holder
(G 585.00-G 585.01)



DE MARTEL-WOLFSON
EG589-00
Kapama pensisi G 585.00-G 585.01 için
Closing forceps for G 585.00-G 585.01
25 cm

Atromatik
Atraumatic



DICK
EH200-00 25.5 cm
EH200-01 26.5 cm
EH200-02 27.5 cm
Güçlü klempler
Pressure clamps



EH200-00
78 mm

EH200-01
88 mm

EH200-02
98 mm

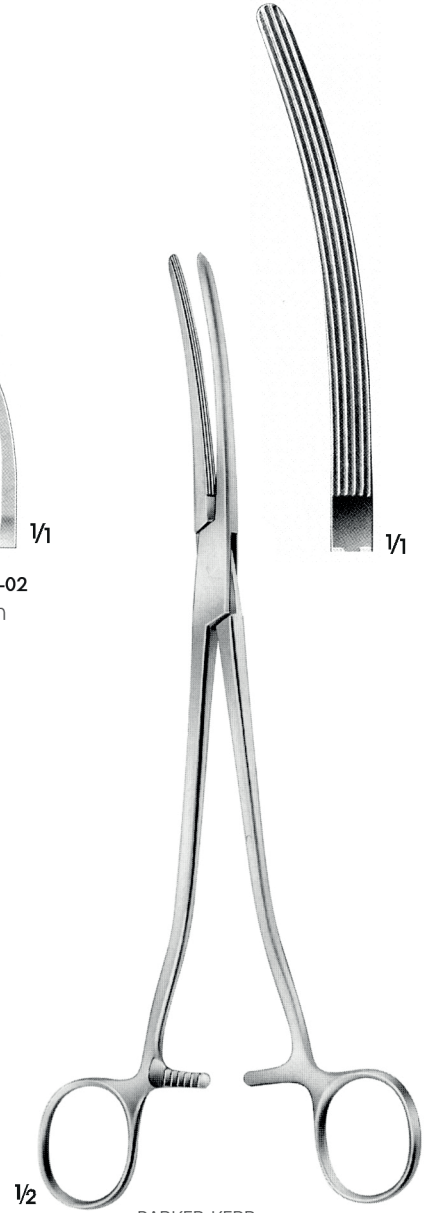

1/2
PARKER-KERR
EG463-02
Anastomoz pensı, kolon
rezeksiyonu için
Anastomosis forceps for
colon resection
25 cm



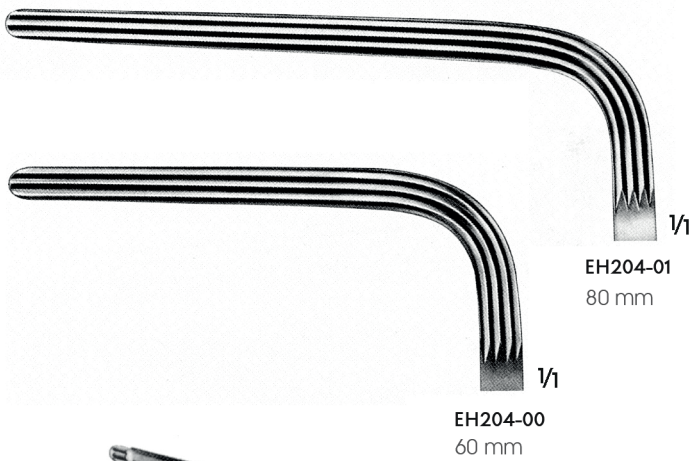

EH204-00-EH204-01
23 cm



1/2

BRUNNER
EG388-02
24.5 cm



1/2

1/2

LLOYD-DAVIS
EG490-02
31.5 cm



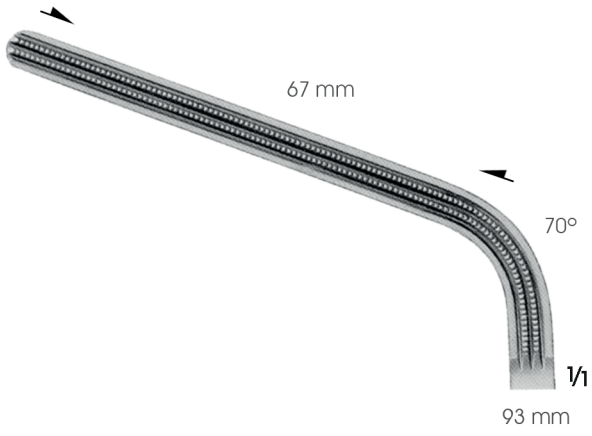

MORRIS
EH460-00
17.5 cm

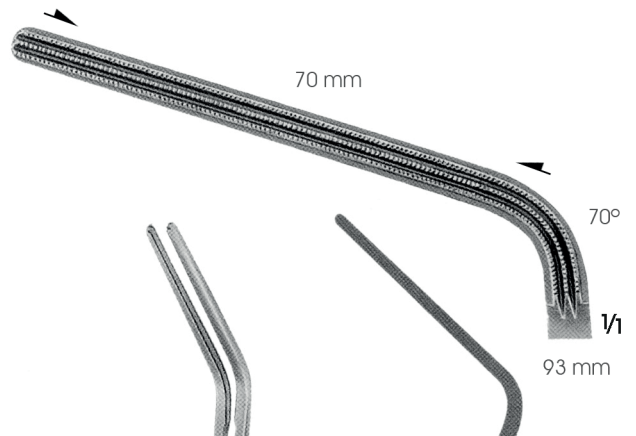

DE BAKEY (MORRIS)
EH461-00
24 cm

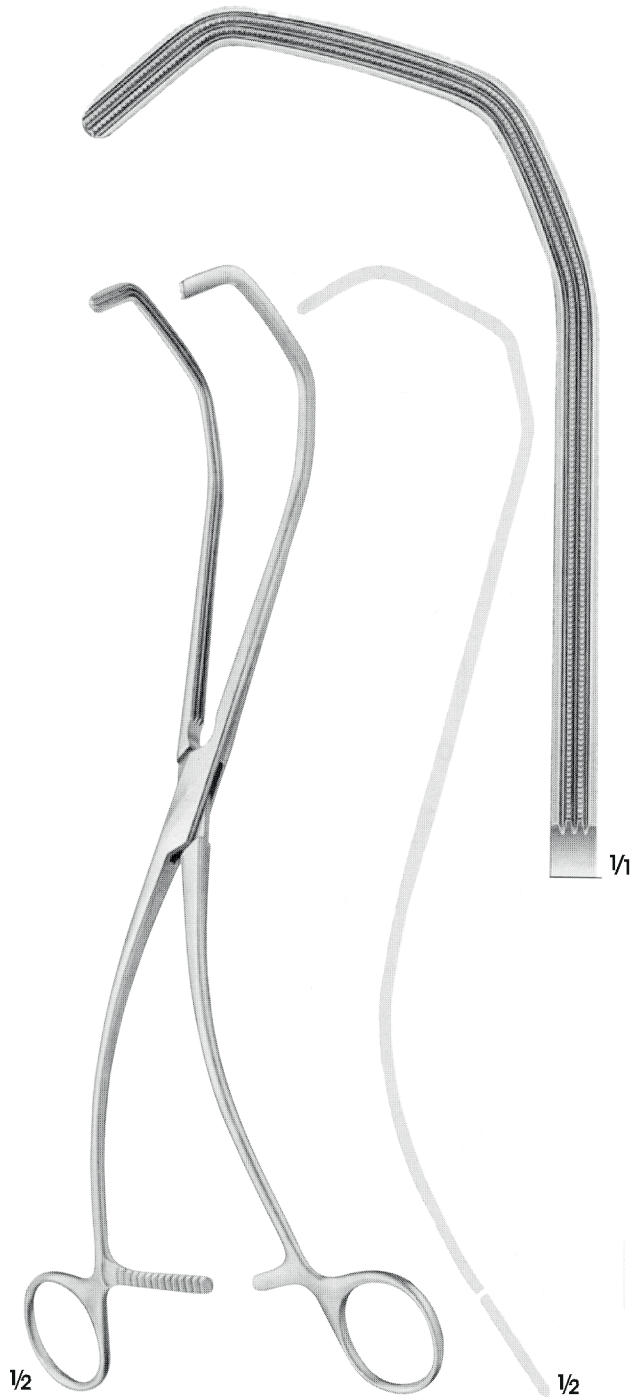

KERSTING
EH375-03
30 cm



RESONE
EH377-03
Yumuşak/Elastic
26.5 cm



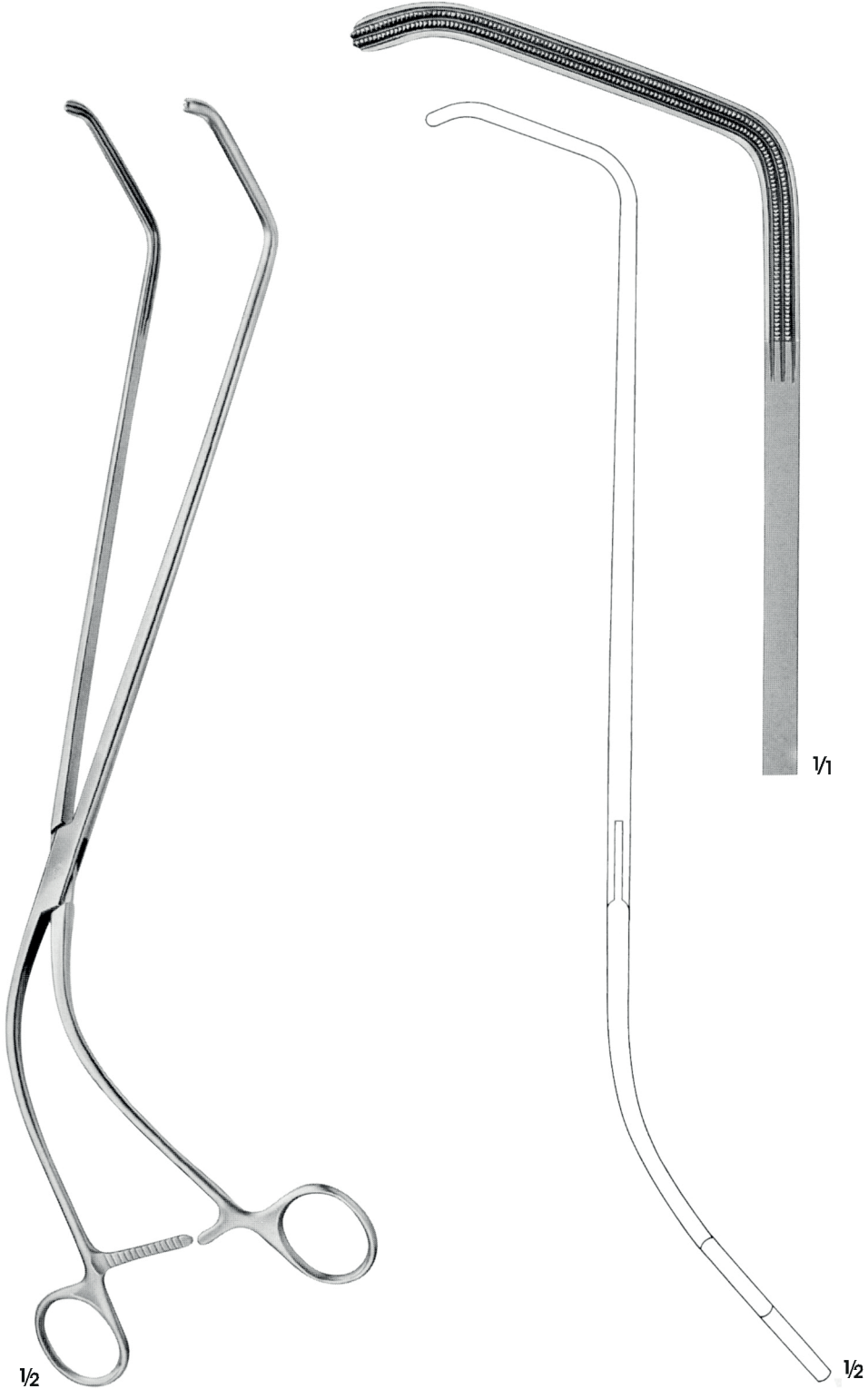

1/2

1/1

1/2

MULLER
EH378-00
Rektal anastomoz klemp
Rectal anastomosis clamp
37.5 cm

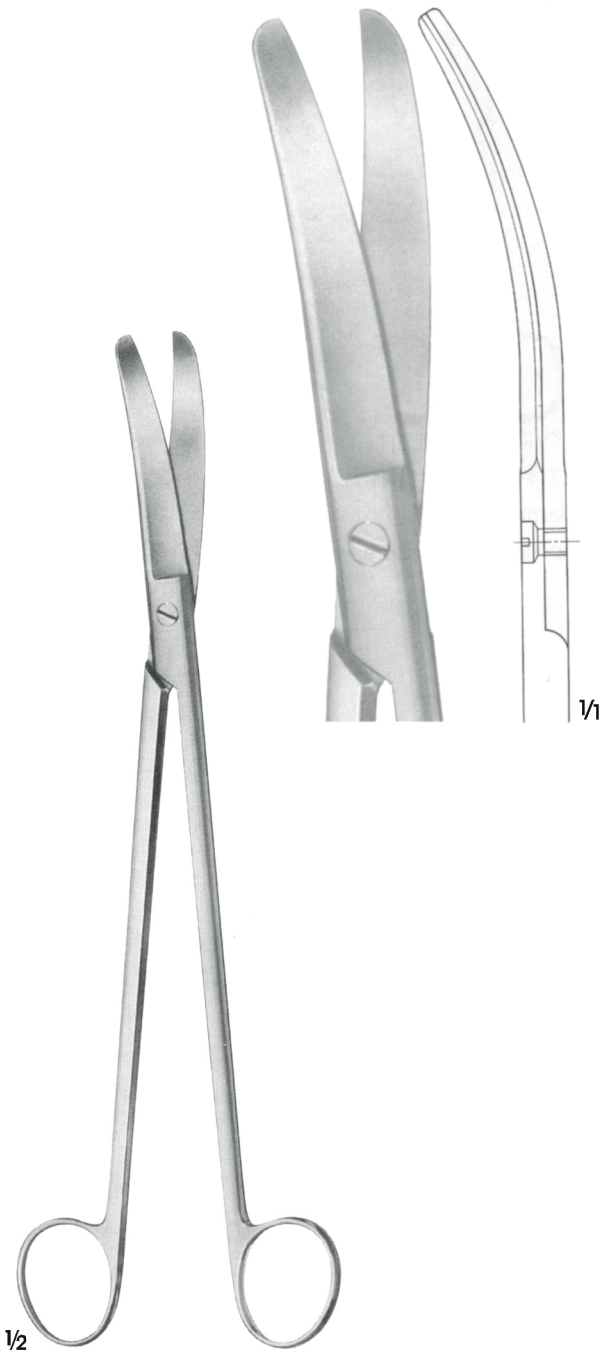

LLOYD-DAVIES (GOLIGHER'S)
EC571-04
27 cm

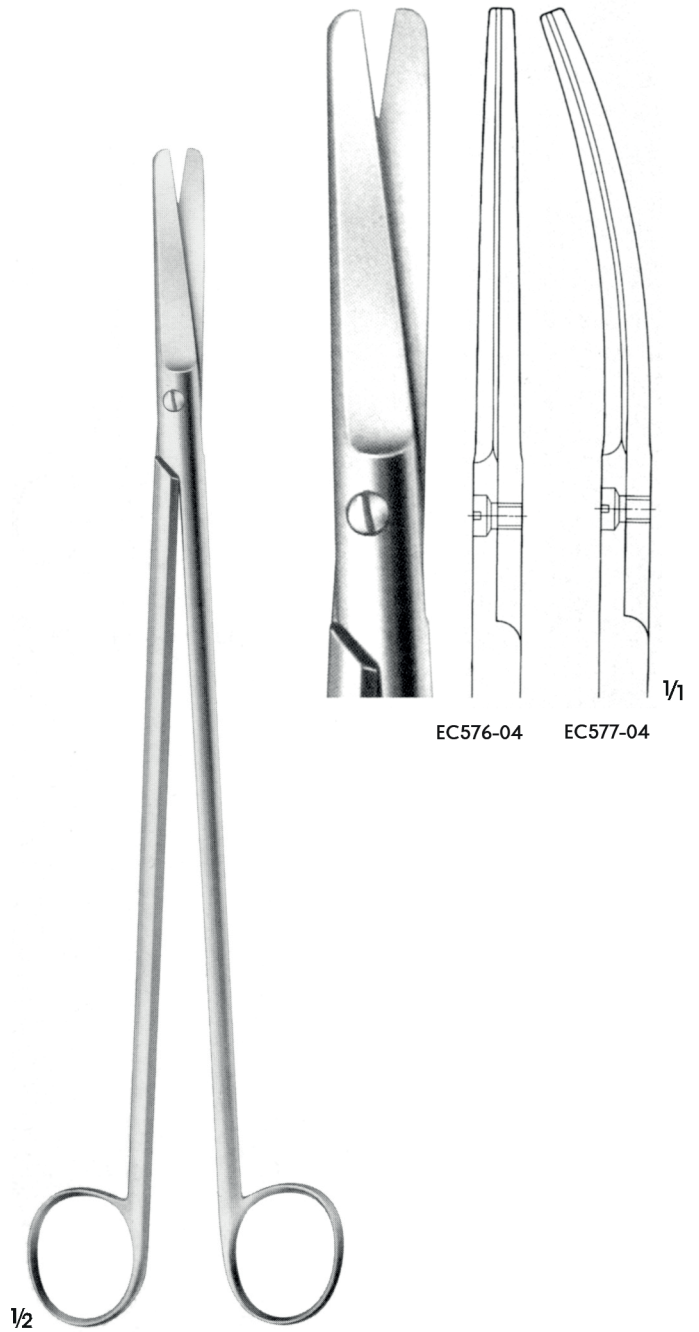

STELZNER
EC576-04-EC577-04
31 cm



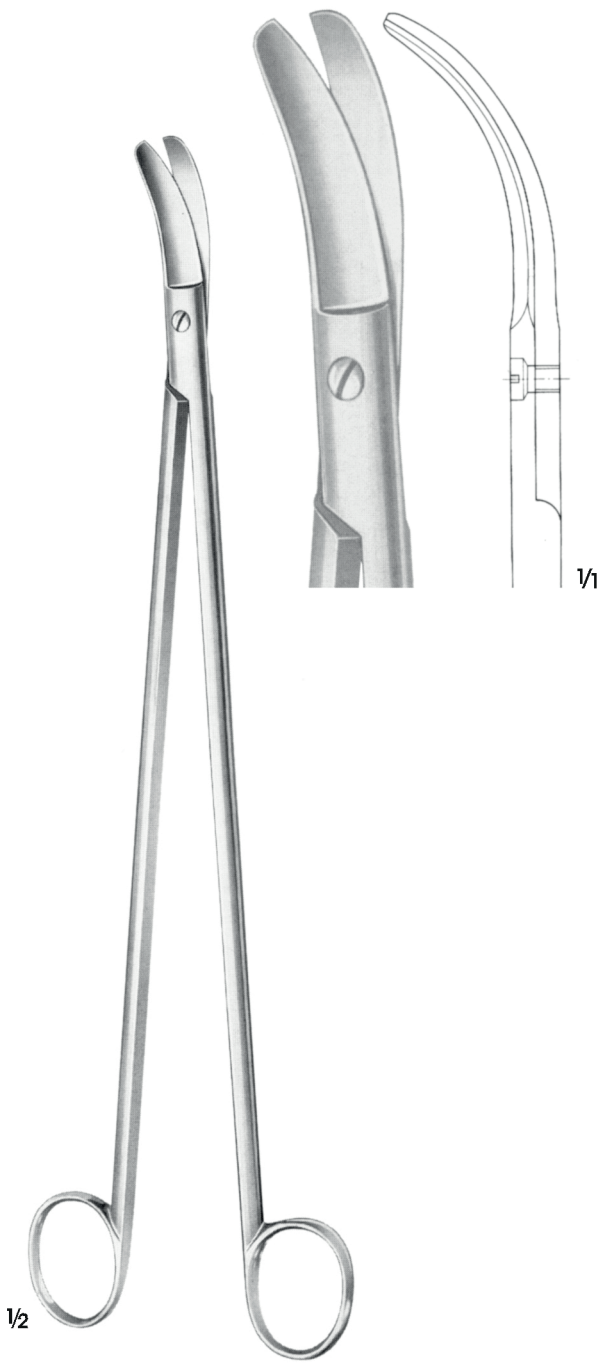

EC579-04
Rektal makas
Rectal scissors
32.5 cm

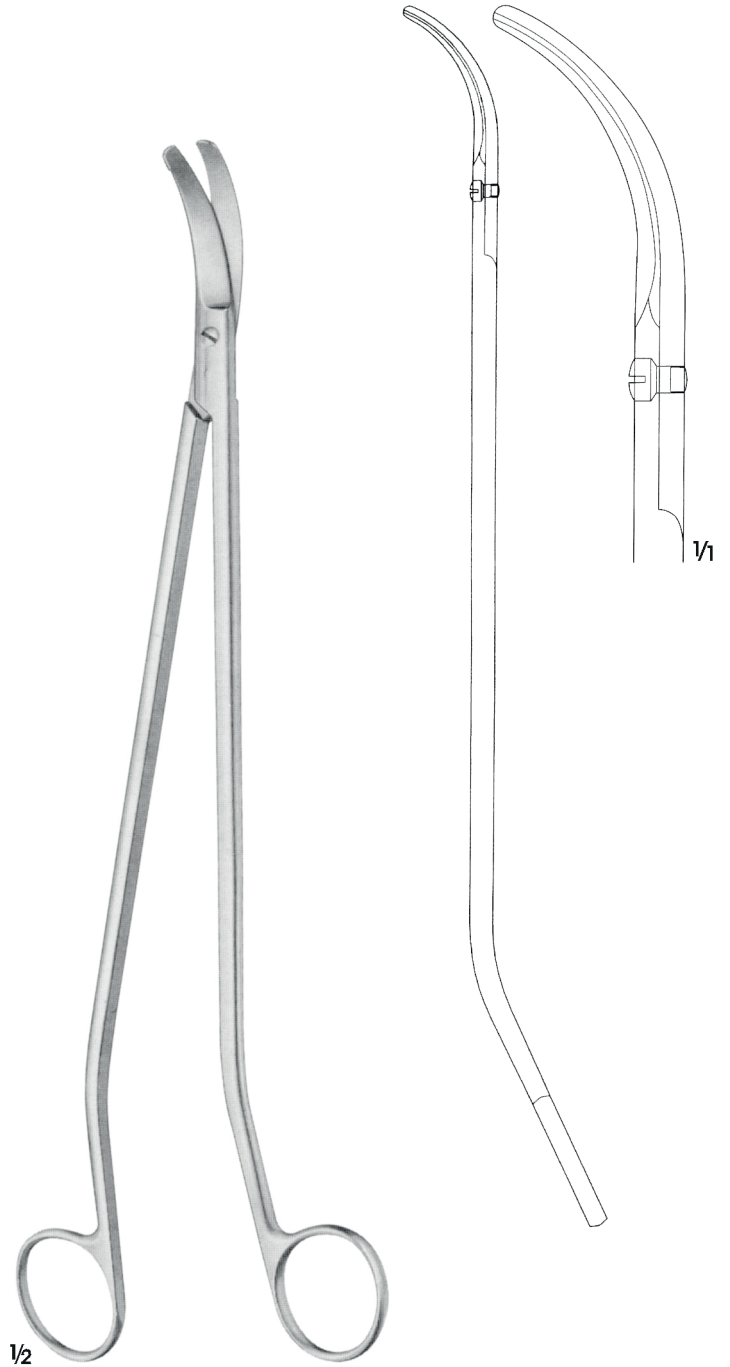

MÜLLER
EC578-00
Rektum makas s şekli
Rectum scissors s-shaped
32.5 cm



ALLIS
EE150-10
Tutma pensi
Grasping forceps
29.5 cm

Atromatik
Atraumatic

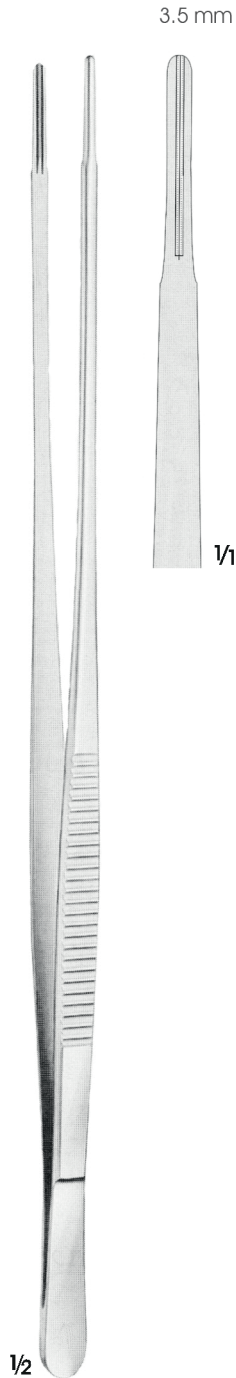

DE BAKEY
ED266-03
35 cm



MÜLLER
EF354-00
Portegü/Needle holder
36 cm



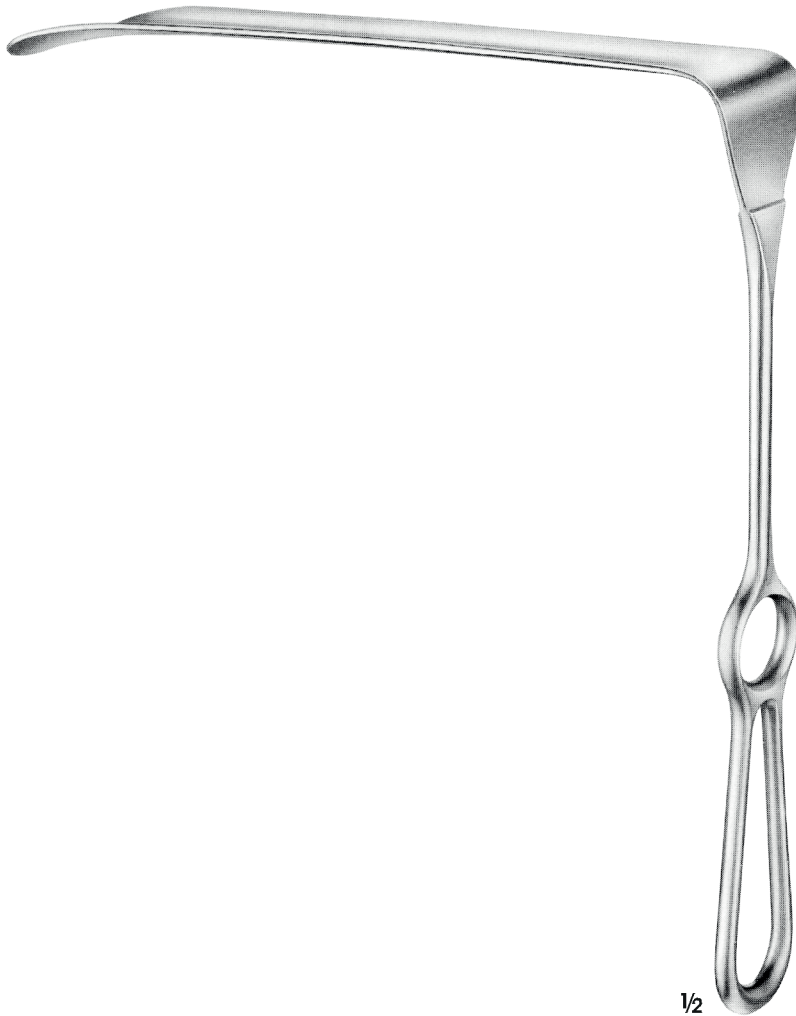
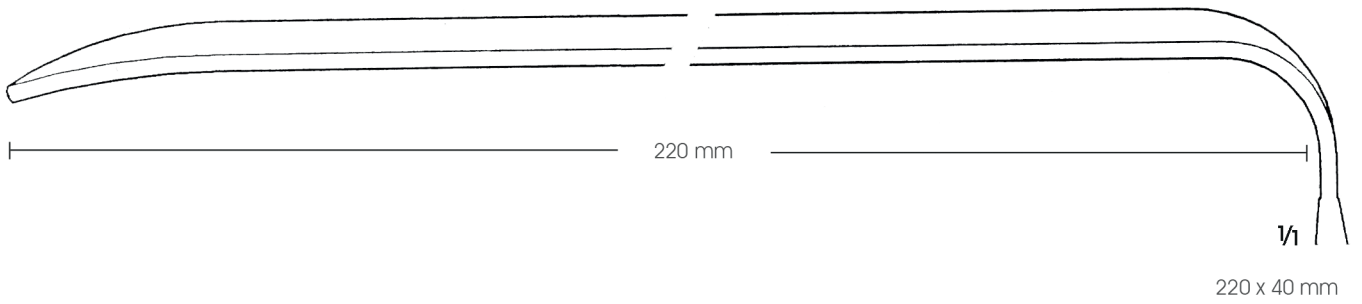

1/2

HÖSEL
EK609-06
Ekartör /Retractor
25 cm

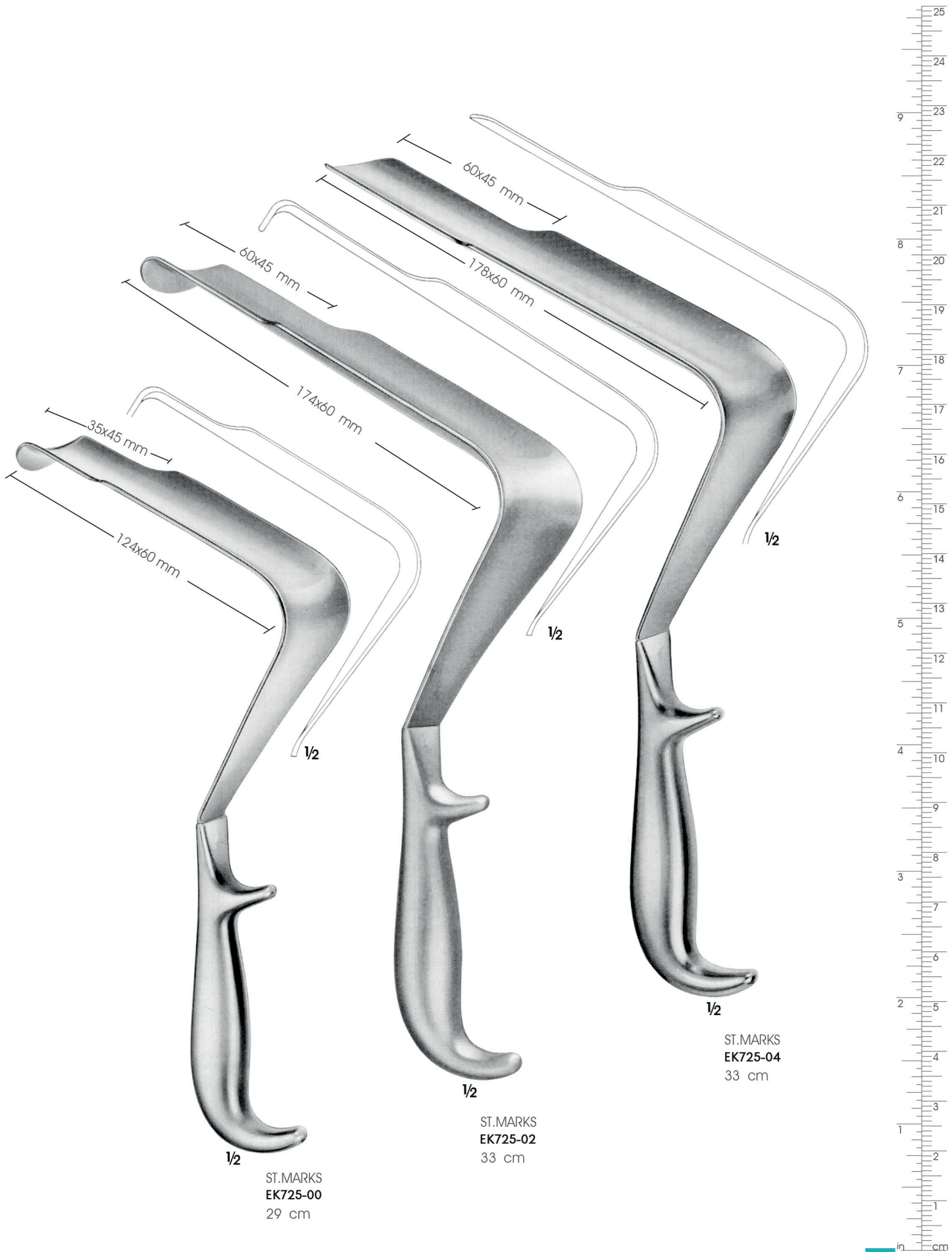

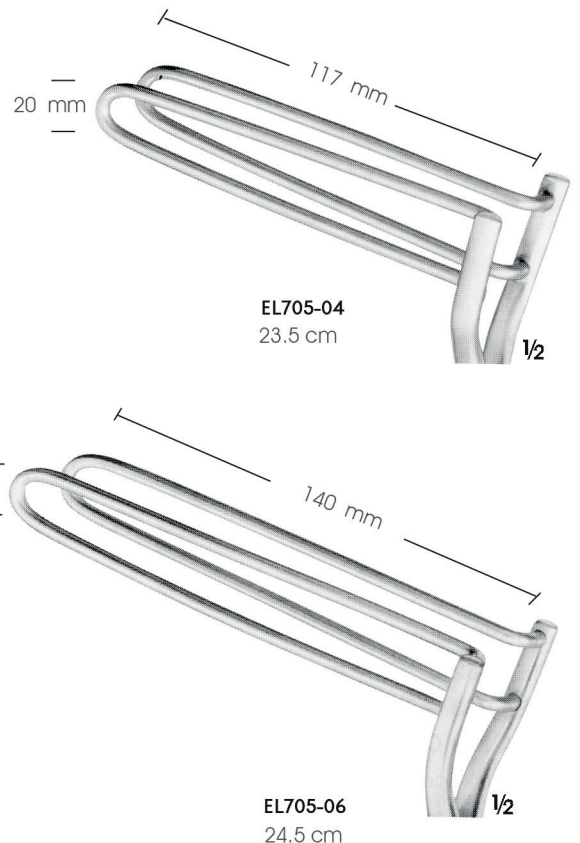
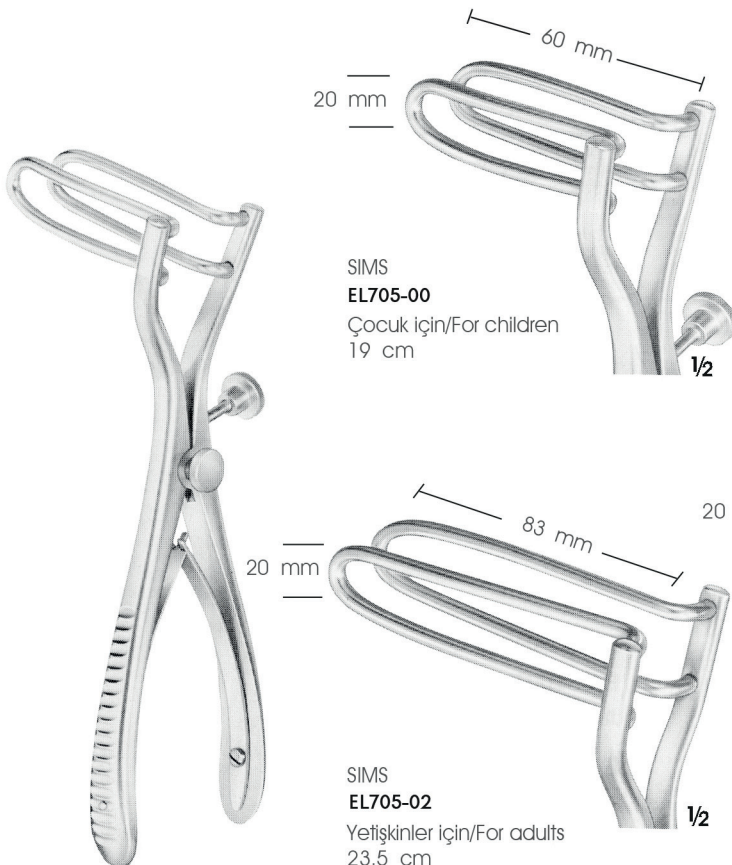
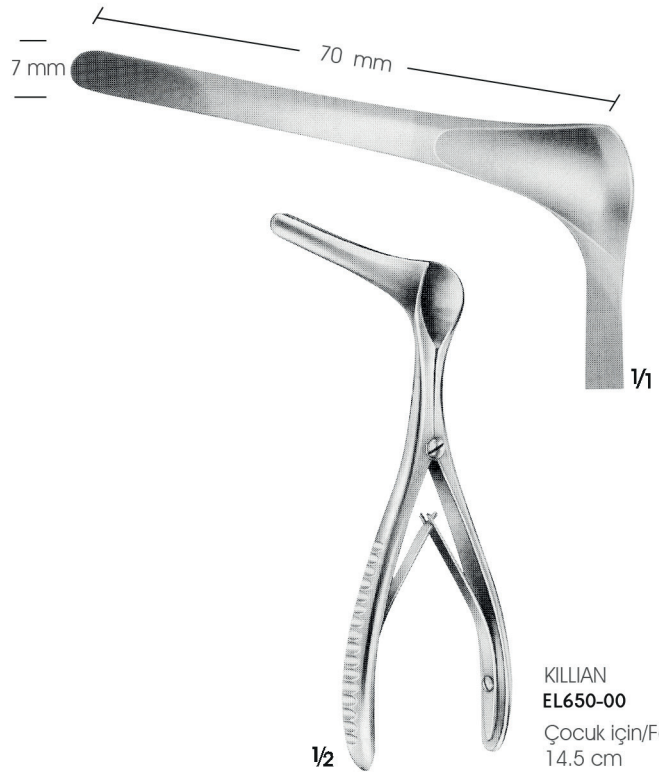
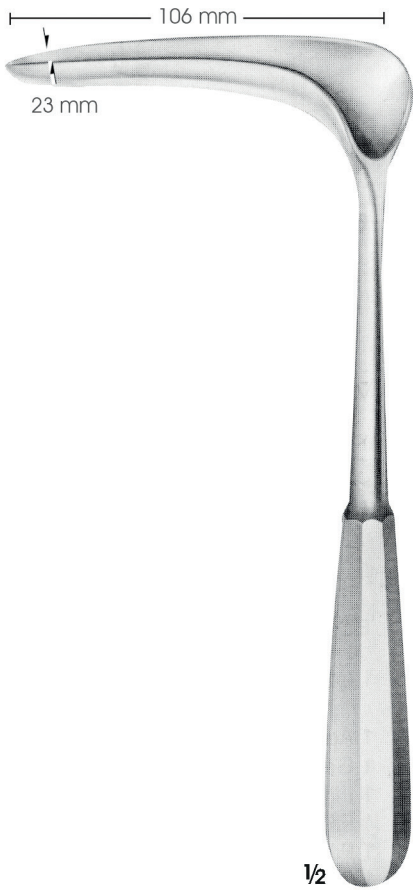



1/2

SIMS
EL707-00
16 cm



1/2

SIMS
EL708-00
16 cm

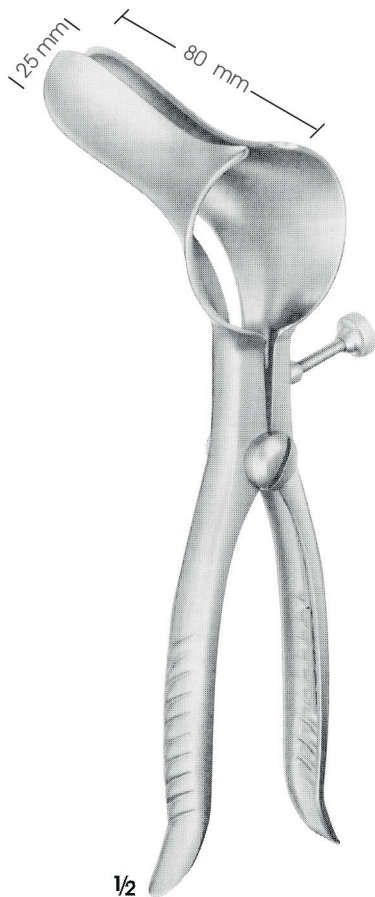

1/2

PRATT
EL710-00
20.5 cm

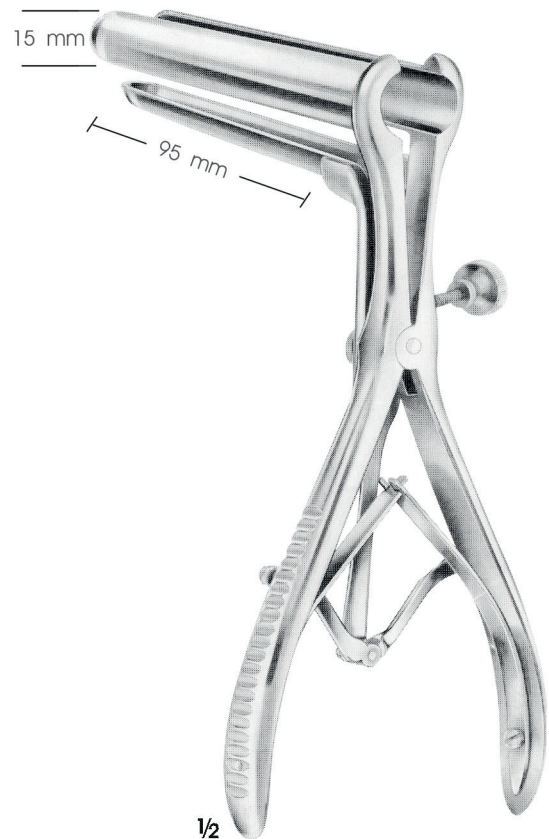

1/2

MATHIEU
EL712-00
21.5 cm





1/2

SIMS
EL714-00
15 cm



100 x 10 mm

1/2

COCK
EL716-00
19 cm



HIRSCHMANN
EL720-00 Ø 16 x 65 mm
EL720-01 Ø 19 x 65 mm
EL720-02 Ø 22 x 65 mm



KELLY
EL721-00 Ø 22 x 50 mm
EL721-01 Ø 22 x 100 mm
EL721-02 Ø 22 x 140 mm



1/2

BENSAUDE
EL725-00 Ø 17 mm
EL720-01 Ø 20 mm
EL720-02 Ø 23 mm
 Anoskoplar/Anoscopes
 18.5 cm



1/2

IVES-FANSLER
EL728-00 Ø 24 mm
 Anoskop/Anoscope
 14.5 cm



1/2

KELLY
EL730-00 Ø 20 mm
 Anoskop/Anoscope
 16 cm



1/2

KELLY
EL730-01 Ø 25 mm
 Sfinteroskop/Sphincteroscope
 16 cm

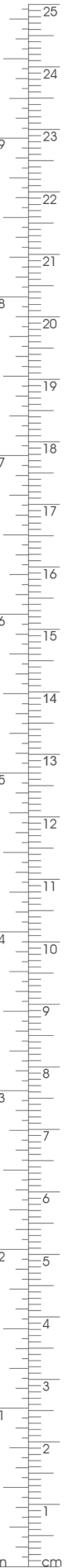

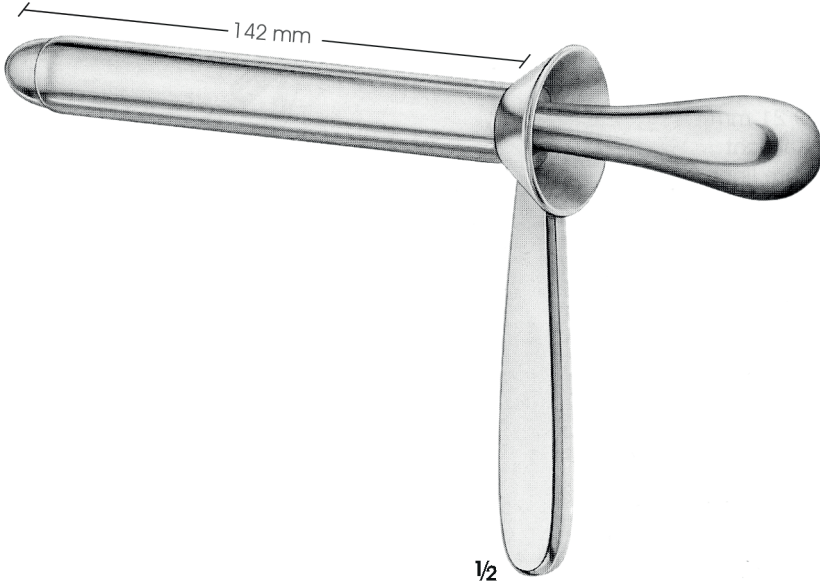

1/2
KELY
EL732-00
Proktoskop
Proctoscope
14 cm



1/1
EL738-10
ACM İngiliz standardı fiber ışık taşıyıcı
Fibre light attachment,
ACM/British standard
for NAUNTON-MORGAN specula

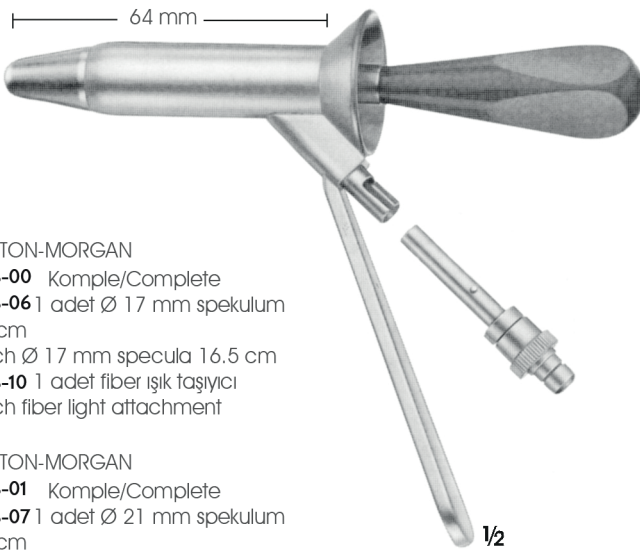

NAUNTON-MORGAN
EL738-00 Komple/Complete
EL738-06 1 adet Ø 17 mm spekulum
16.5 cm
1 each Ø 17 mm specula 16.5 cm
EL738-10 1 adet fiber ışık taşıyıcı
1 each fiber light attachment

NAUNTON-MORGAN
EL738-01 Komple/Complete
EL738-07 1 adet Ø 21 mm spekulum
16.5 cm
1 each, Ø 21 mm specula 16.5 cm
EL738-10 1 adet fiber ışık taşıyıcı
1 each fiber light attachment

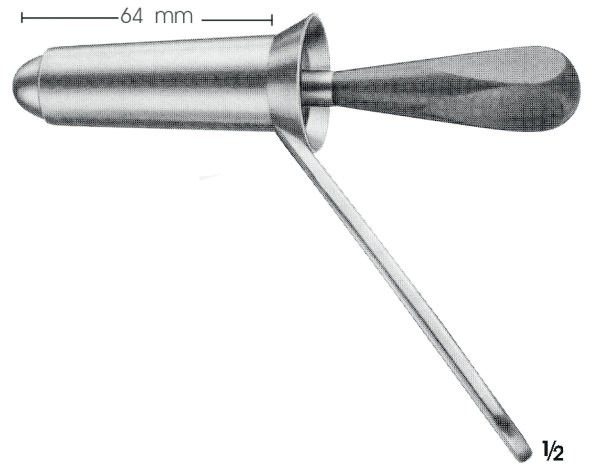

NAUNTON-MORGAN
EL738-02 Komple/Complete
EL738-08 adet Ø 24 mm spekulum
16.5 cm
1 each Ø 24 mm specula 16.5 cm
EL738-10 1 adet fiber ışık taşıyıcı
1 each fiber light attachment

GABRIEL
EL736-00 Ø 25 mm
Rektal spekulum
Rectal speculum

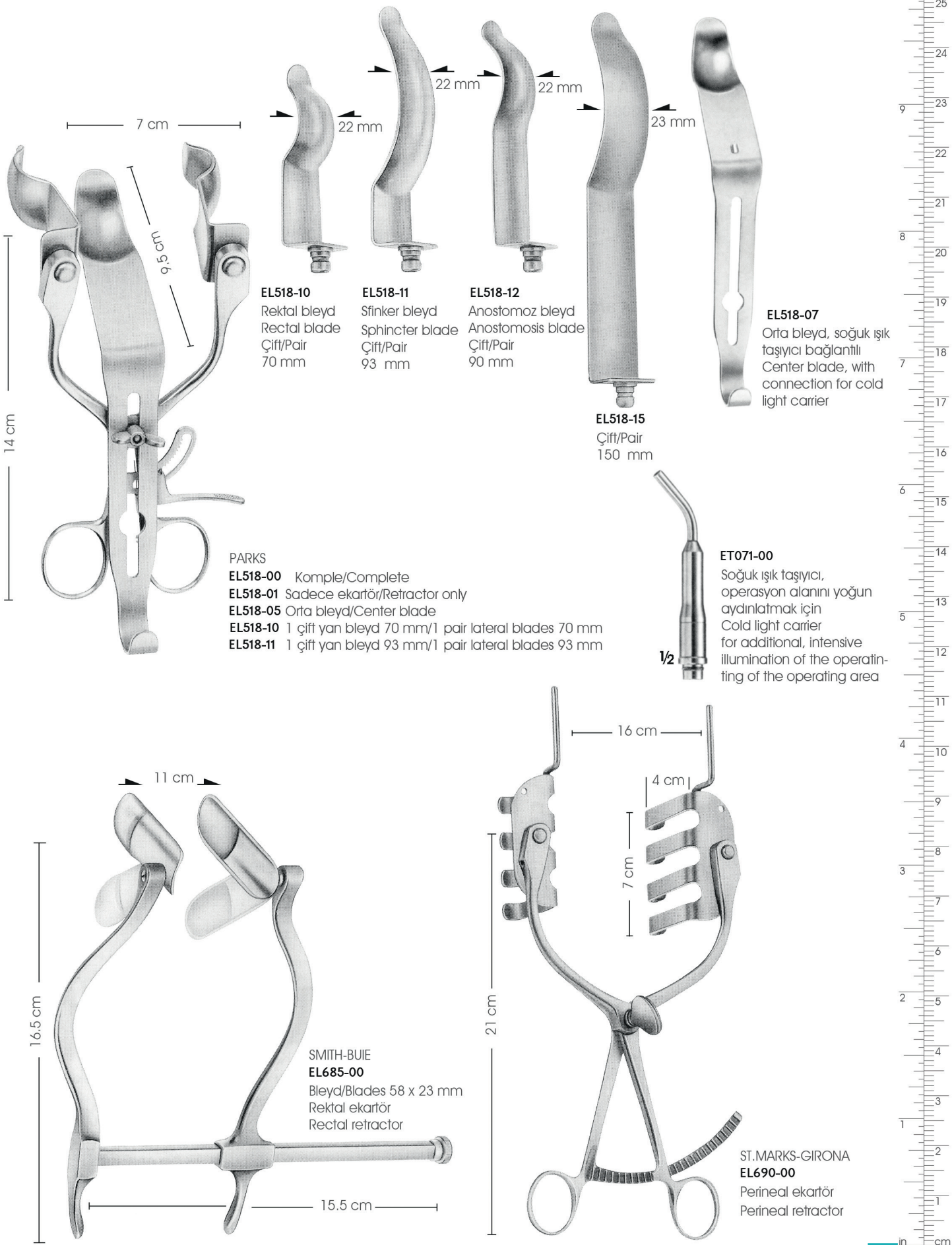

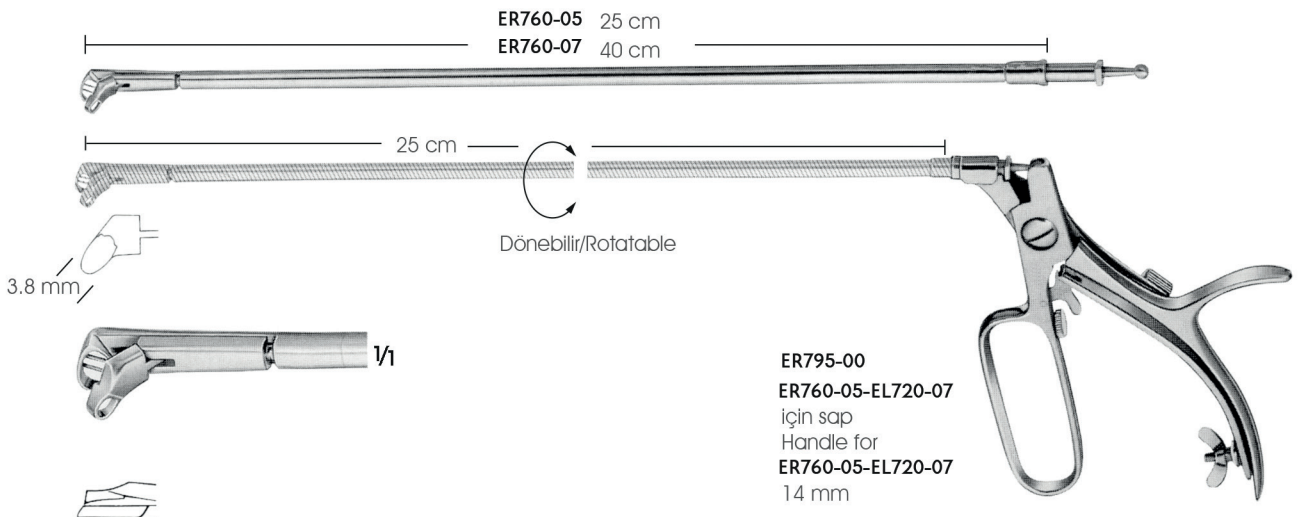
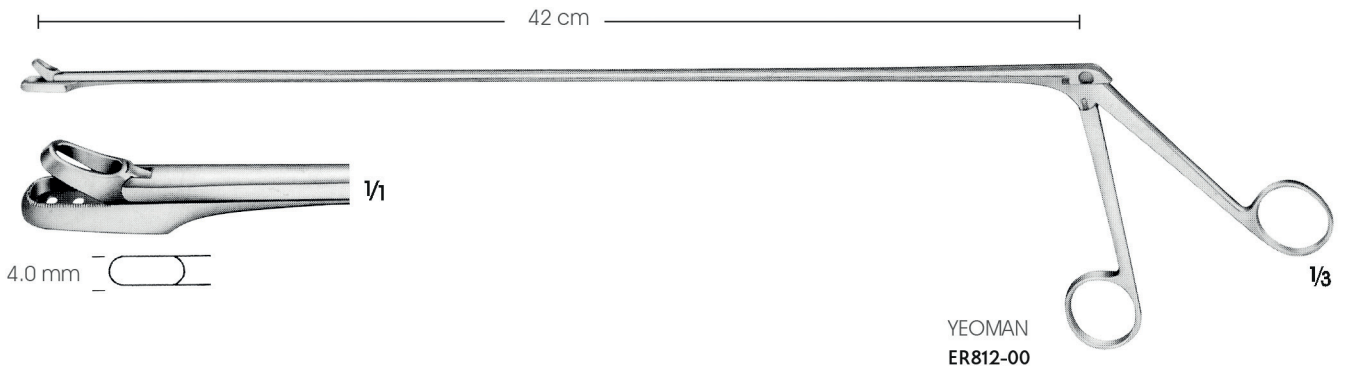
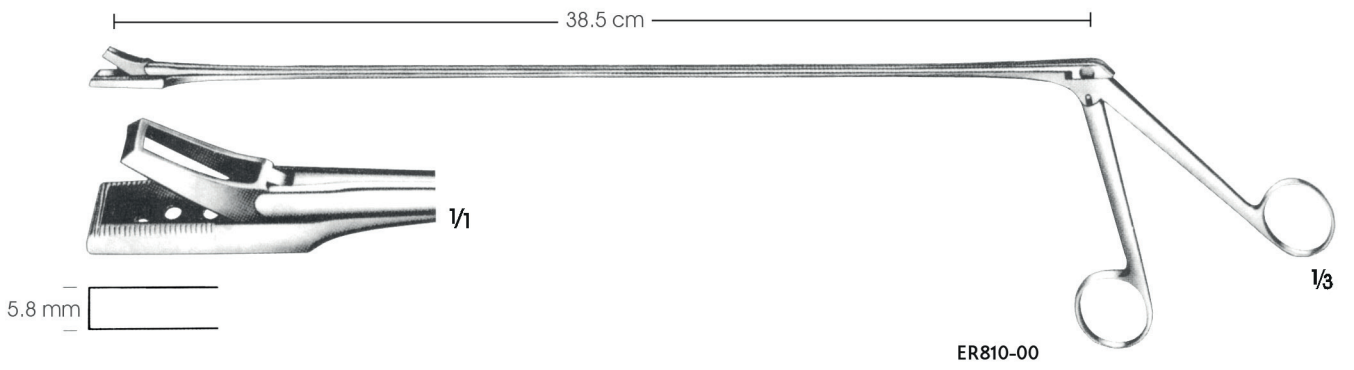
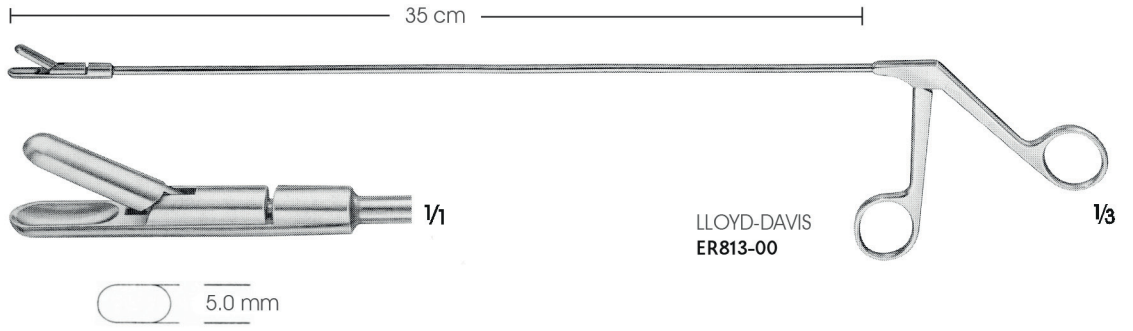

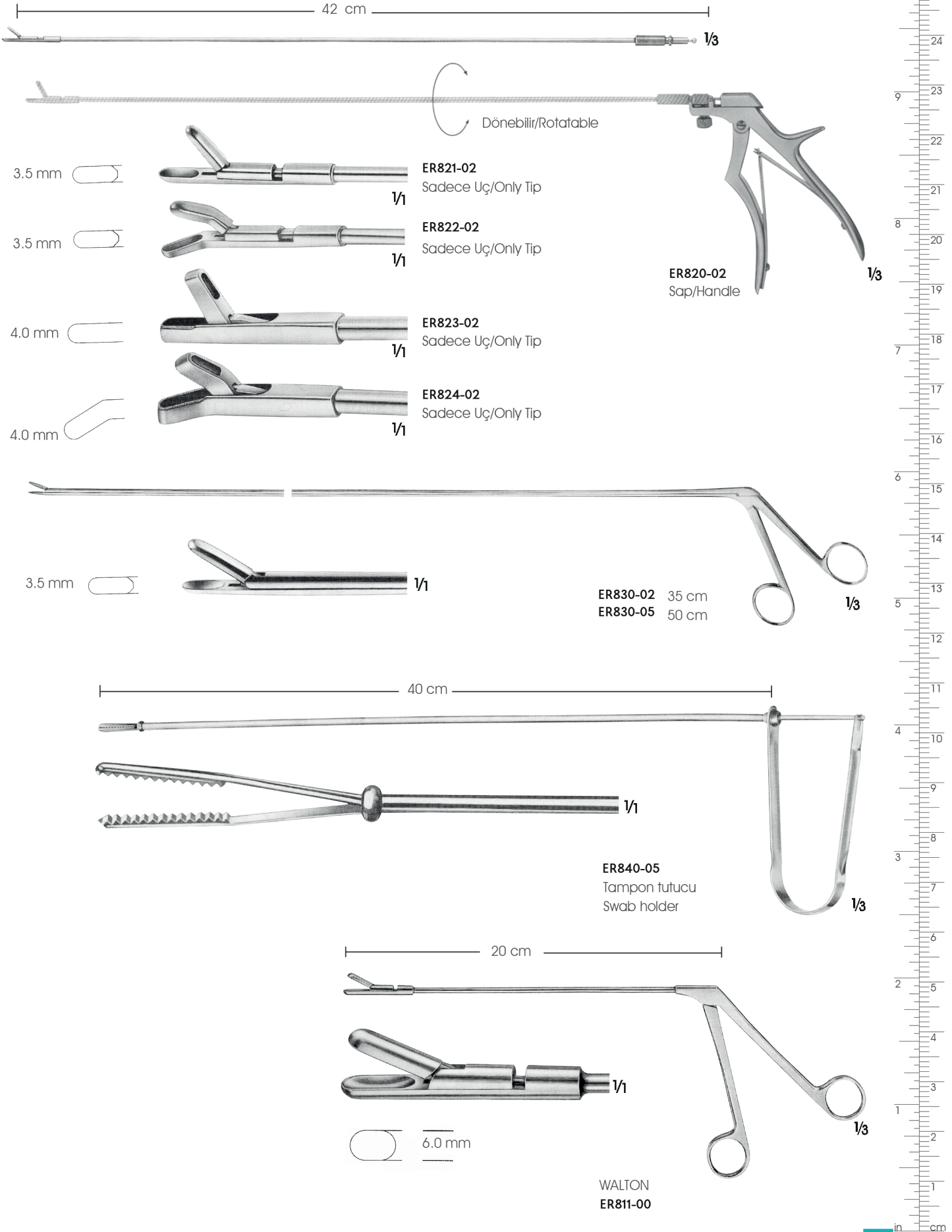

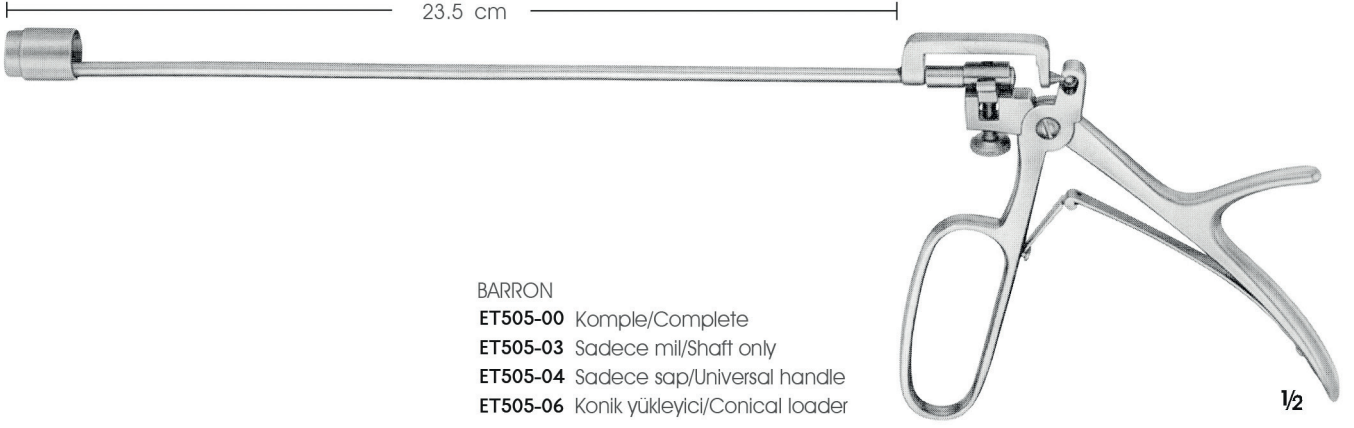

BARRON
ET505-00 Komple/Complete
ET505-03 Sadece mil/Shaft only
ET505-04 Sadece sap/Universal handle
ET505-06 Konik yükleyici/Conical loader

1/2



MC GIVNEY
EG570-00
Hemoroid pens
Hemorrhoidal forceps
18.5 cm

1/2

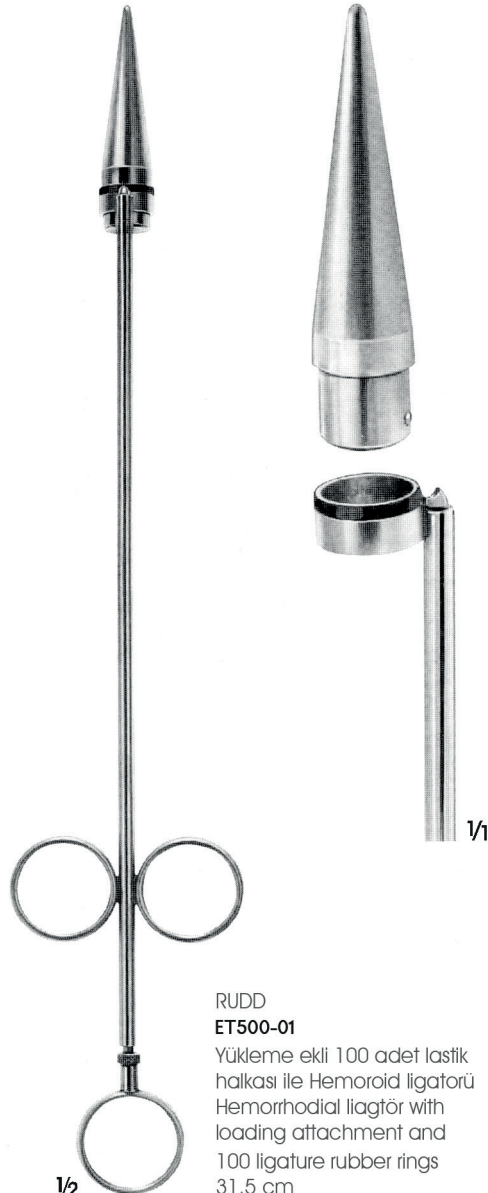

RUDD
ET500-01
Yükleme ekli 100 adet lastik halkası ile Hemoroid ligatörü
Hemorrhoidal ligatör with loading attachment and 100 ligature rubber rings
31.5 cm

1/2

1/1



1/1

ET509-00
100 Adet/Paket
100 Pcs/Pack

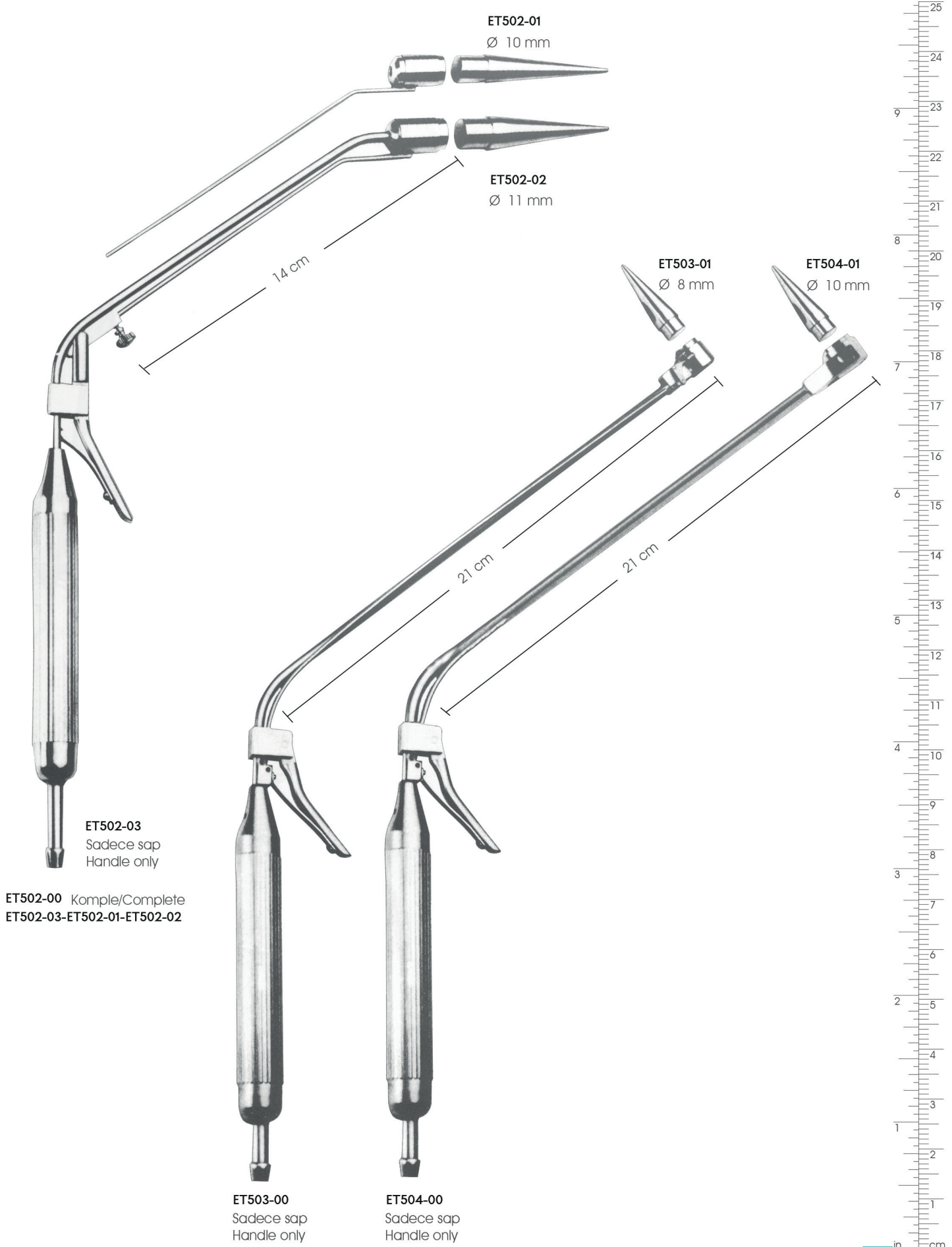

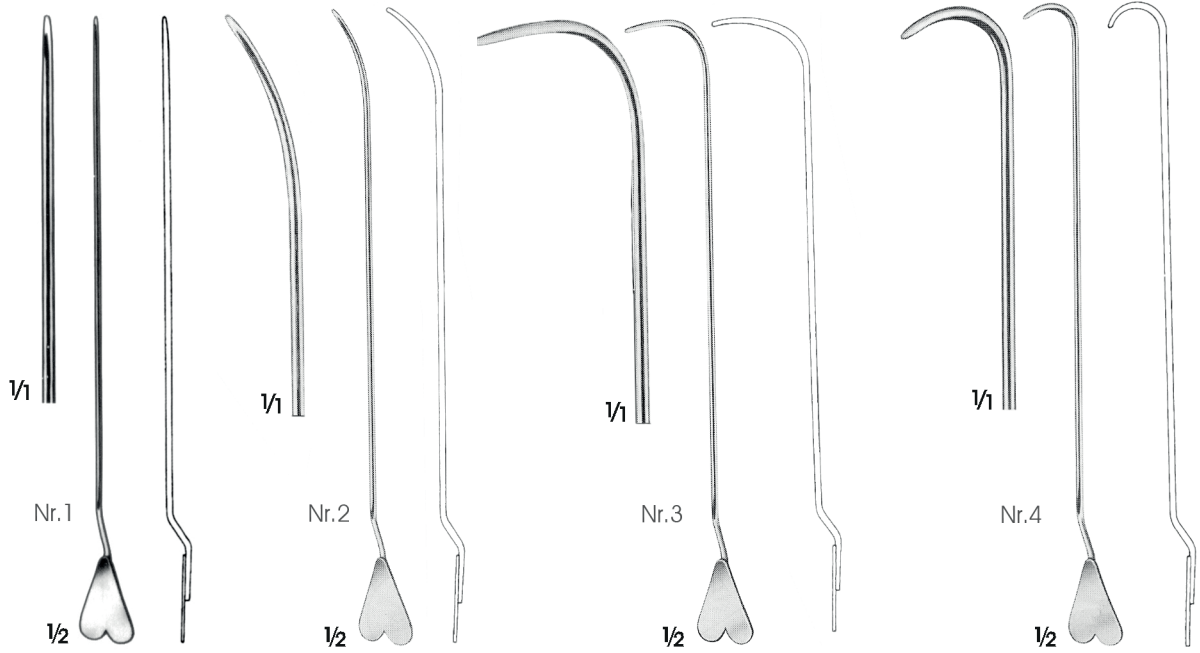

LOCKHART-MUMMERY

Fistül sonda/Fistula probes

EJ020-00 Nr.1 Düz/Straight

EJ020-01 Nr.2 45° Eğri/Curved

EJ020-02 Nr.3 90° Eğri/Curved

EJ020-03 Nr.4 Geriye doğru eğri/Curved retrograde
16,5 cm

Ø 3.5 mm

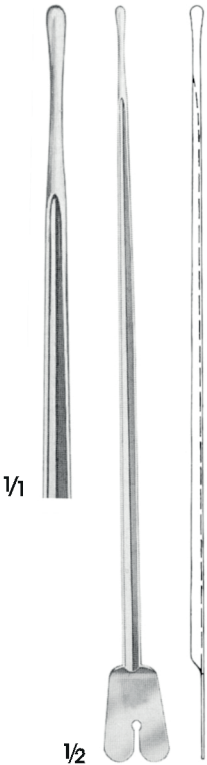

BIRODIE
EJ018-00
20 cm



EJ024-00
Bükülebilir/Malleable
19 cm

Ø 3 mm



EJ037-00
Çift delikli ve uçlu
bükülebilir sonda
Double ended probe,
malleable, with hole
19 cm



EK227-00
Fistül sonda
Fistula probe
24 cm

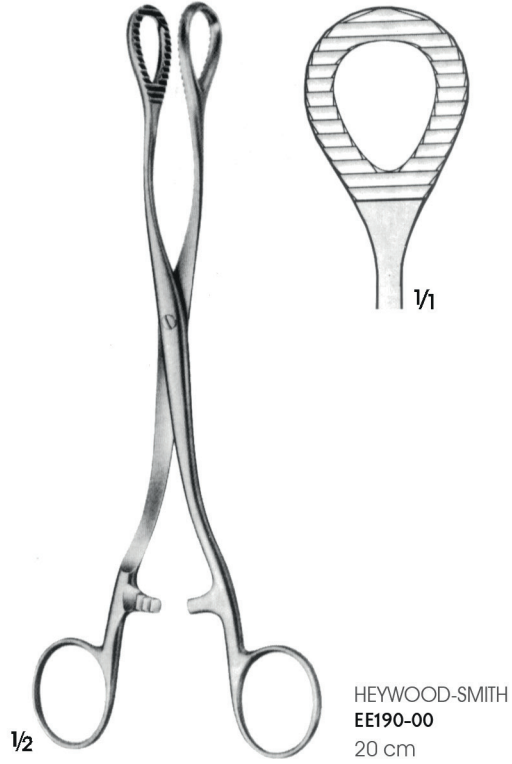
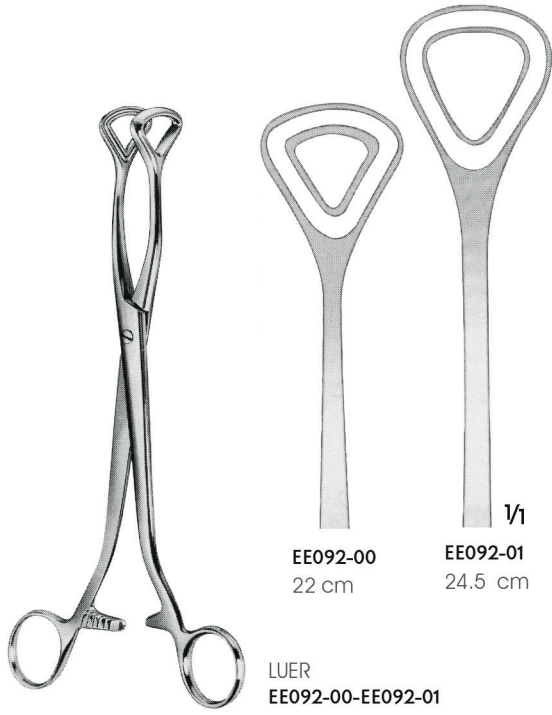

Atromatik
Atraumatic

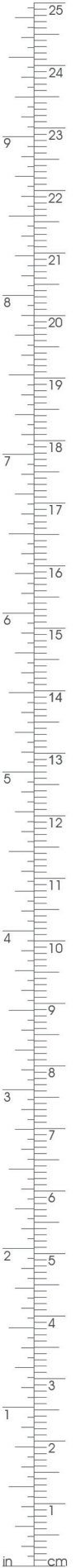
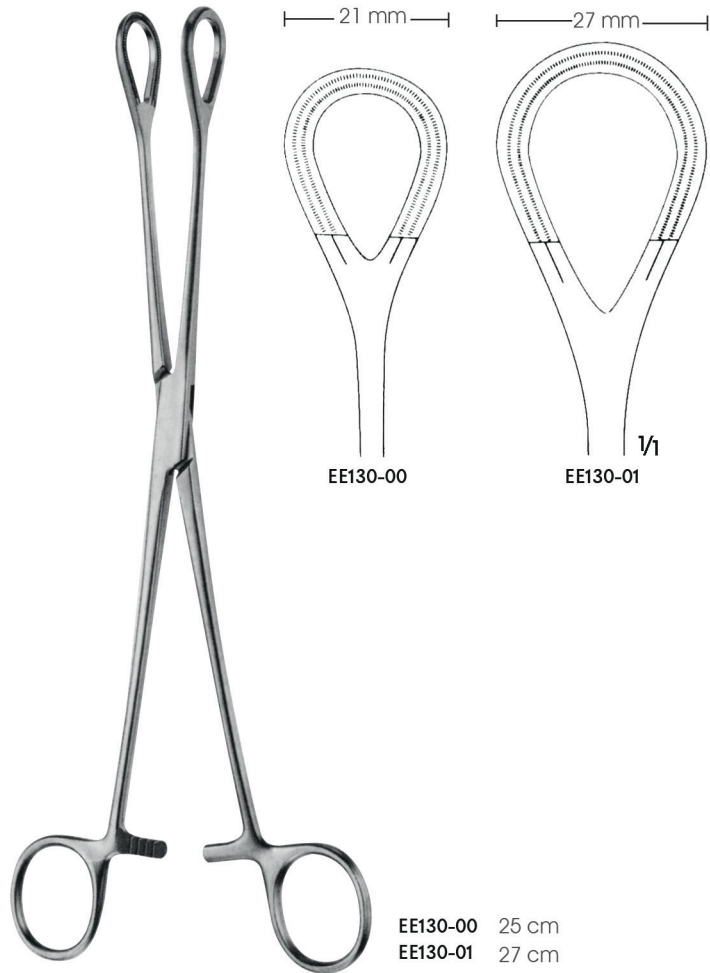
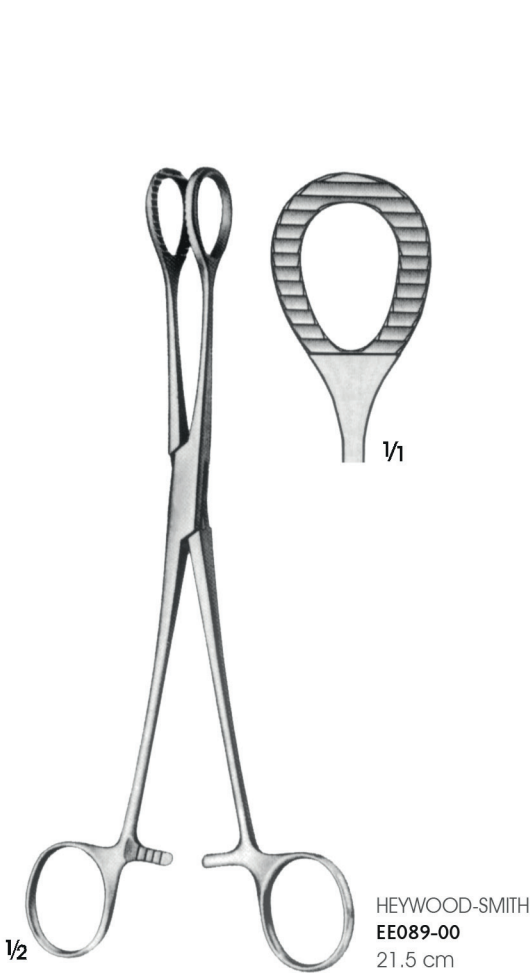

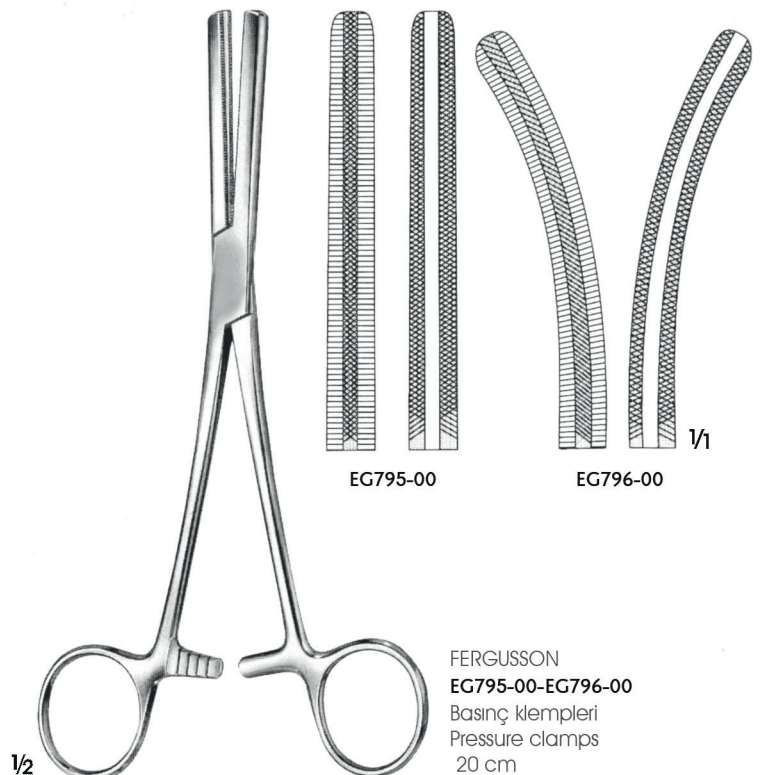
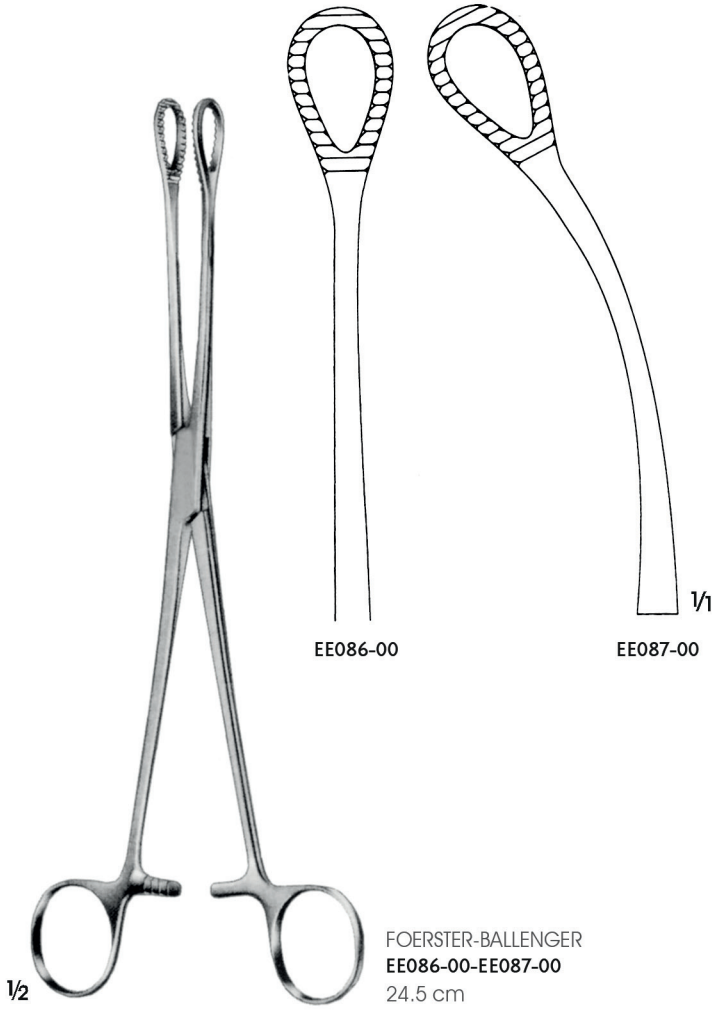

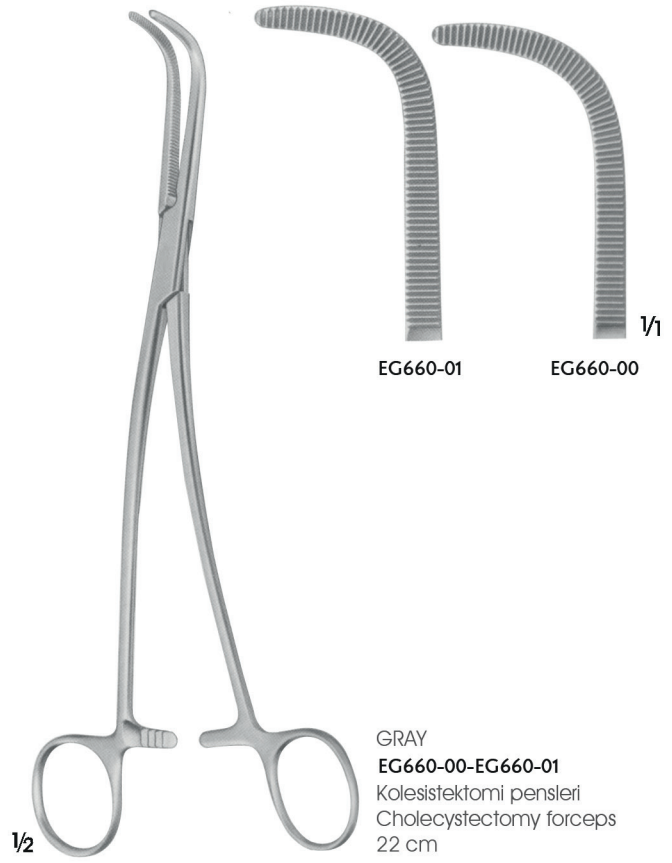

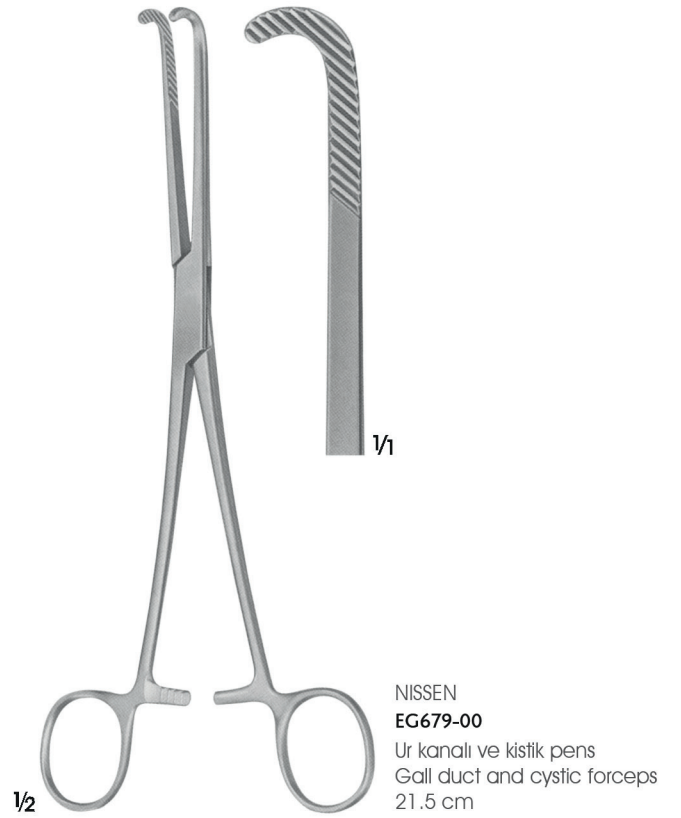
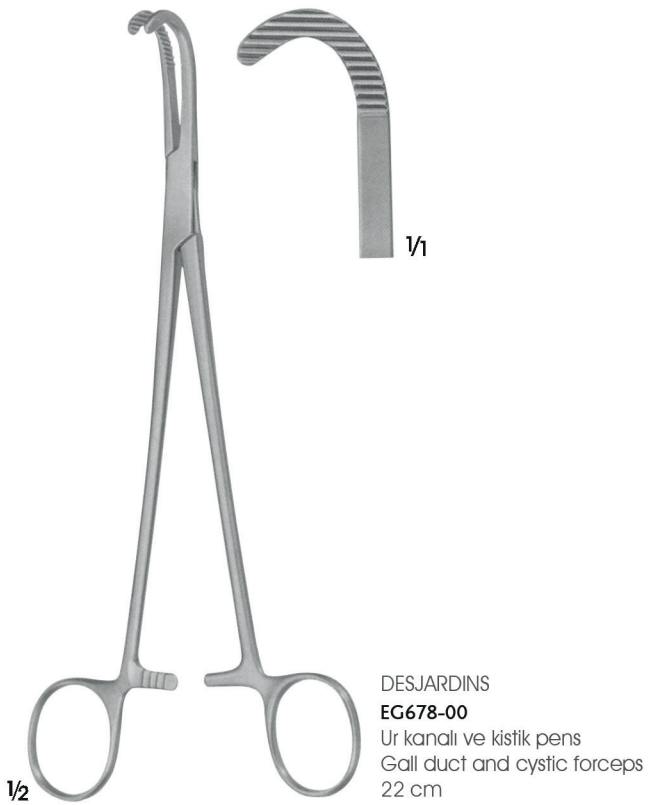
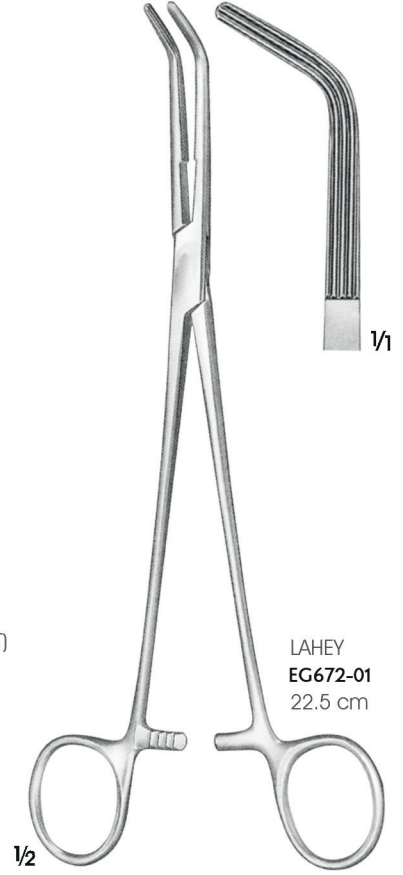

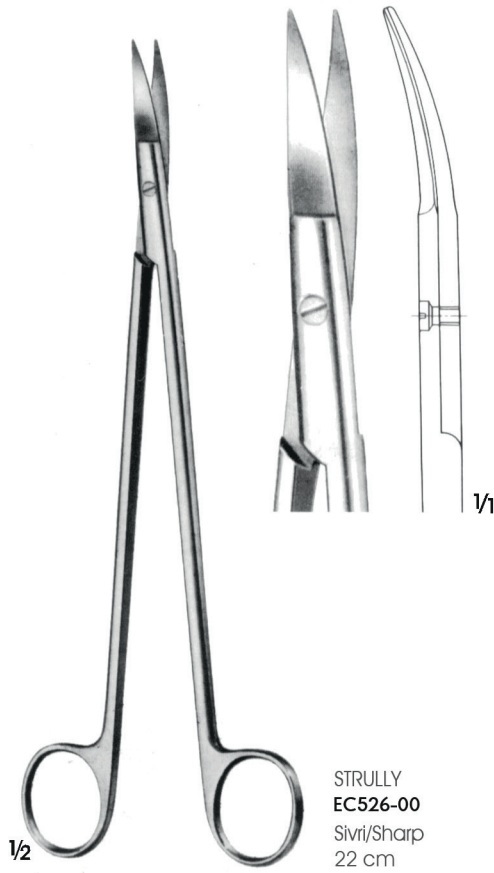

STRULLY
EC526-00
Sivri/Sharp
22 cm

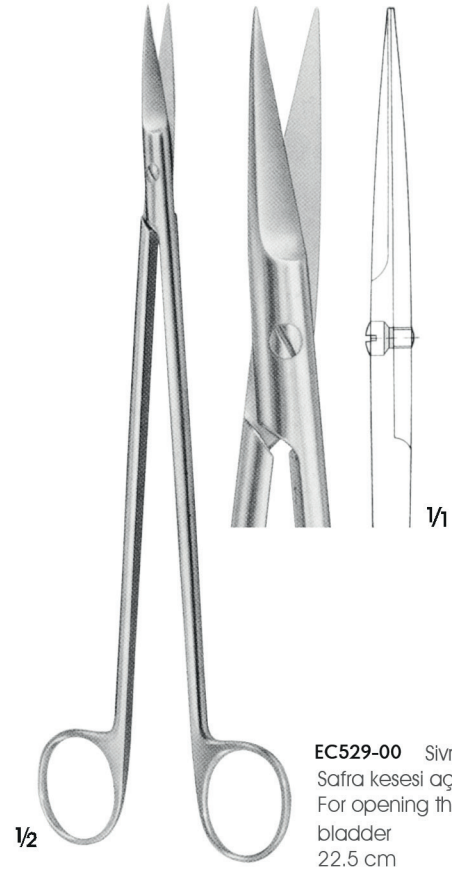

EC529-00 Sivri/Sharp
Safra kesesi açıcı
For opening the gall
bladder
22.5 cm

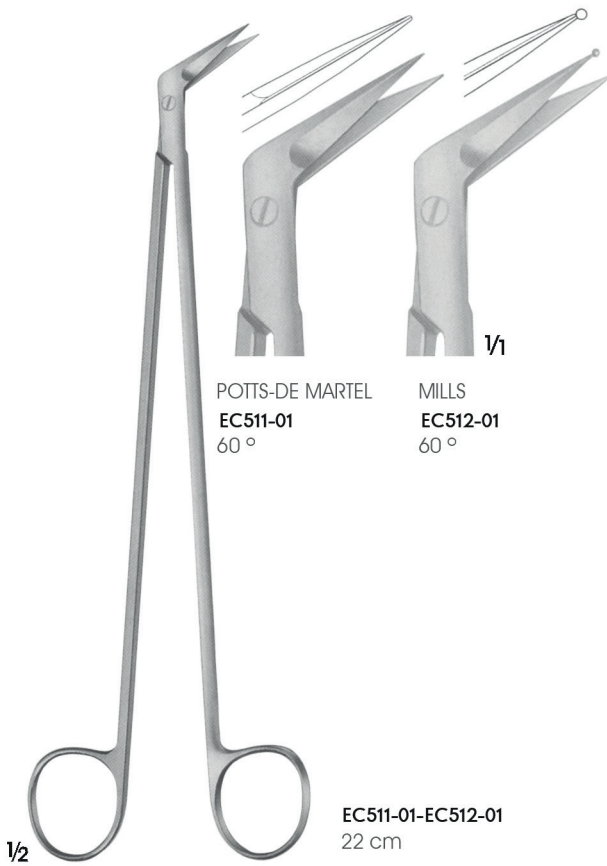

POTTS-DE MARTEL
EC511-01
60°

MILLS
EC512-01
60°

EC511-01-EC512-01
22 cm



60°

DE BAKEY
EC790-01
22 cm



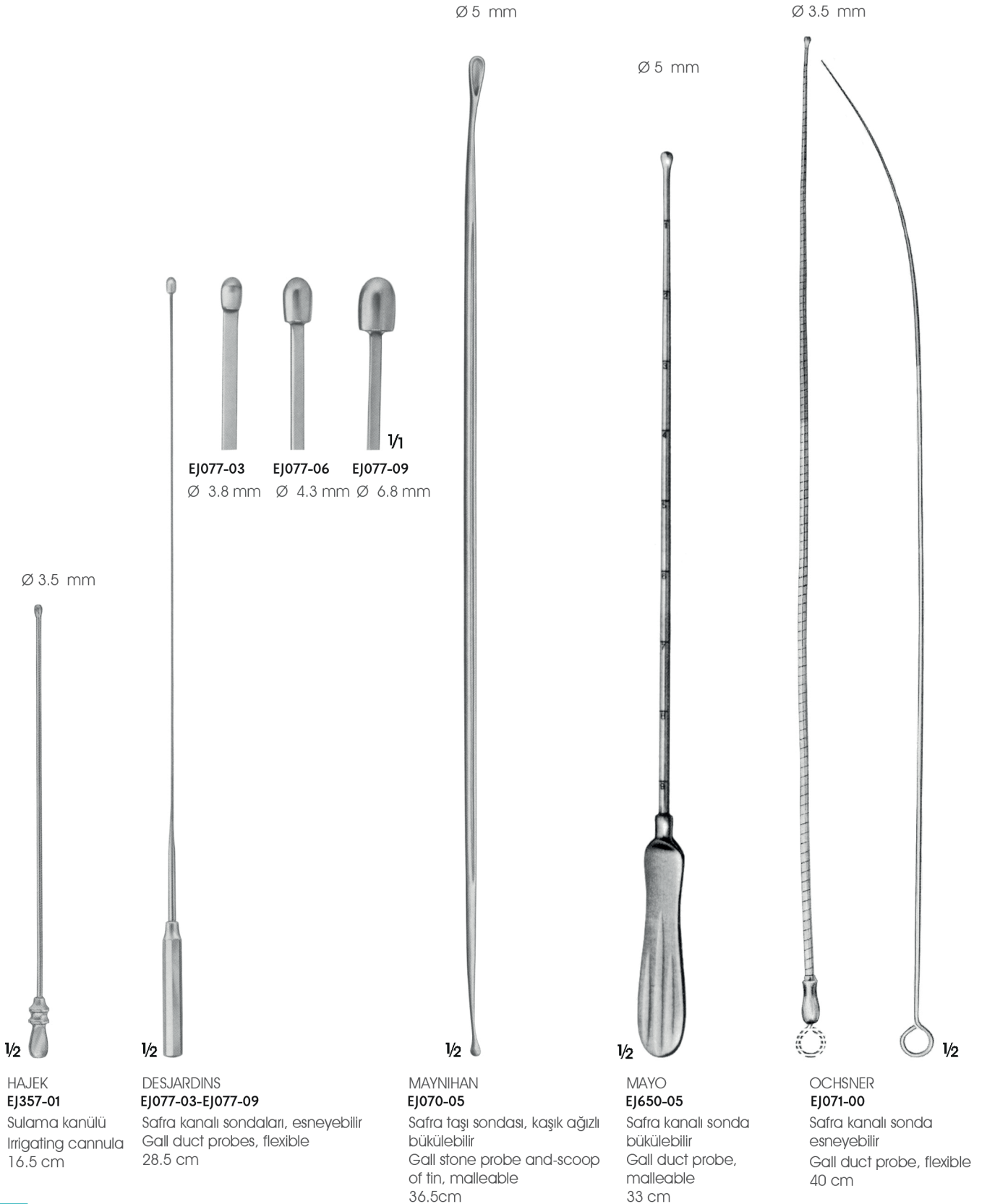

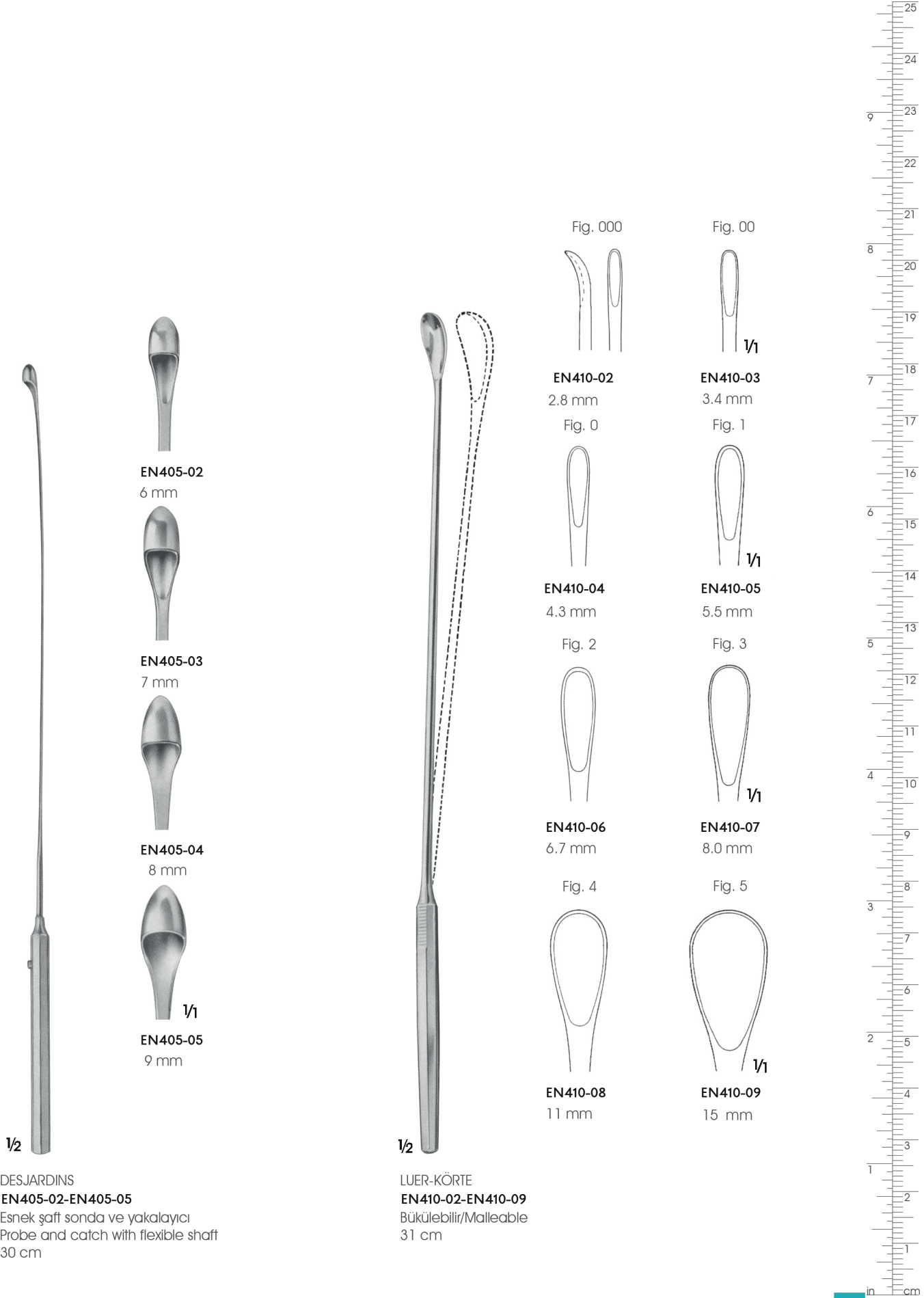

DESJARDINS
EN405-02-EN405-05
Esnek şaft sonda ve yakalayıcı
Probe and catch with flexible shaft
30 cm

LUER-KÖRTE
EN410-02-EN410-09
Bükülebilir/Malleable
31 cm

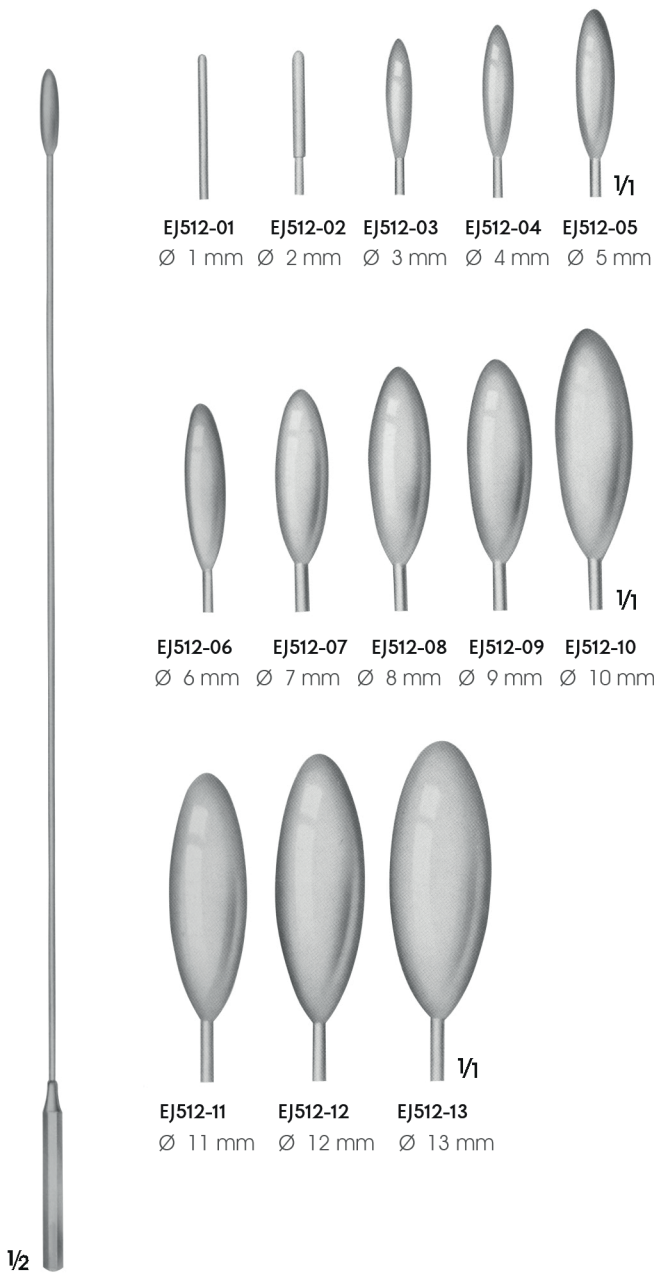

BAKES

EJ512-01-EJ512-013

Safra kanalı için bükülebilir dilatörler
Common bile duct dilators, malleable
31 cm



DITTEL

EJ080-08-EJ080-30

Metal buji ve dilatasyon sondaları
Metal bougies and dilating sounds
34.5 cm

Charr.
(French)

EJ080-08	8
EJ080-09	9
EJ080-10	10
EJ080-11	11
EJ080-12	12
EJ080-13	13
EJ080-14	14
EJ080-15	15
EJ080-16	16
EJ080-17	17
EJ080-18	18
EJ080-19	19
EJ080-20	20
EJ080-21	21
EJ080-22	22
EJ080-23	23
EJ080-24	24
EJ080-25	25
EJ080-26	26
EJ080-27	27
EJ080-28	28
EJ080-29	29
EJ080-30	30



EJ082-10

EJ082-09

EJ082-08

EJ082-07

EJ082-06

EJ082-05

EJ082-04

EJ082-03

- EJ082-03 Ø 3 mm
 - EJ082-04 Ø 4 mm
 - EJ082-05 Ø 5 mm
 - EJ082-06 Ø 6 mm
 - EJ082-07 Ø 7 mm
 - EJ082-08 Ø 8 mm
 - EJ082-09 Ø 9 mm
 - EJ082-10 Ø 10 mm
- 19 cm

1/2

1/1



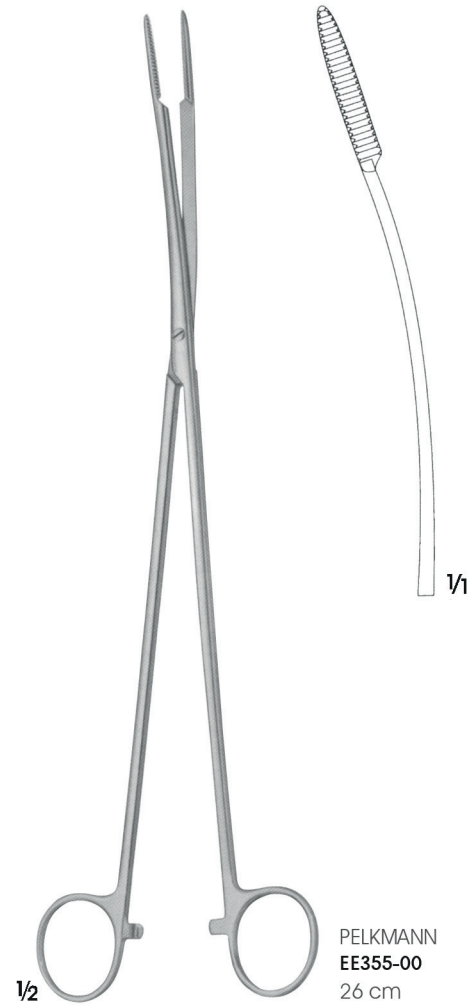
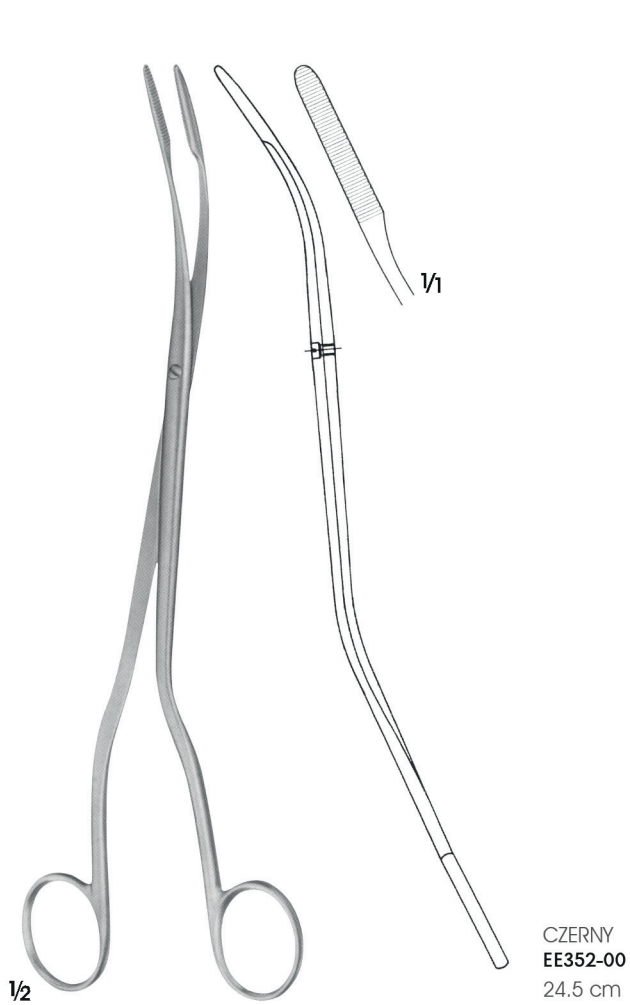
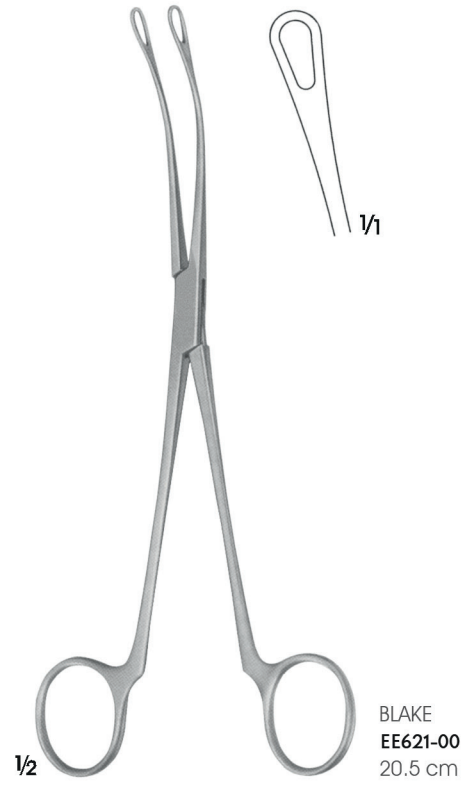
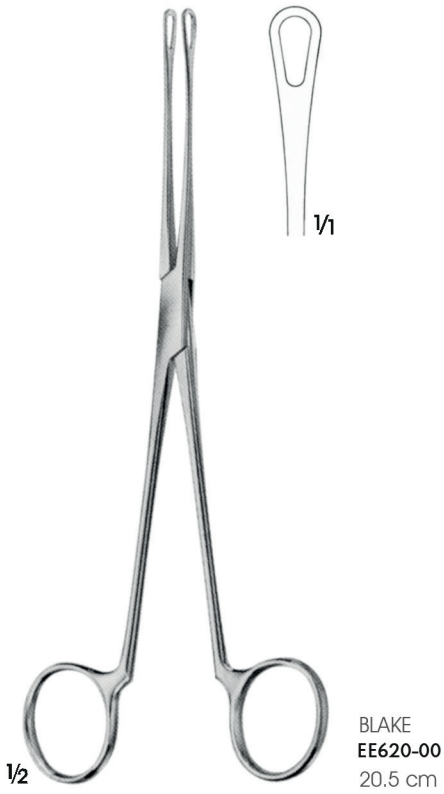

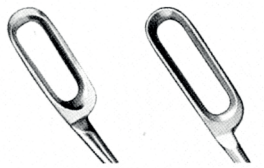
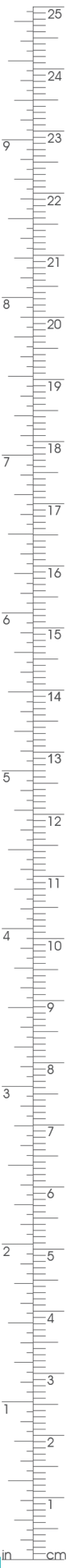

EE610-02 EE610-04



EE610-03 EE610-05



EE612-02
24 cm



EE612-01
22.5 cm

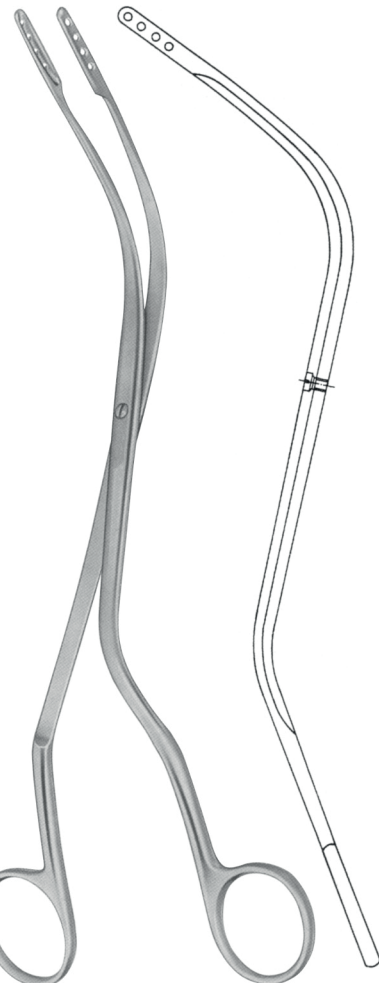

TÜBINGER
EE613-00
25.5 cm



1/1

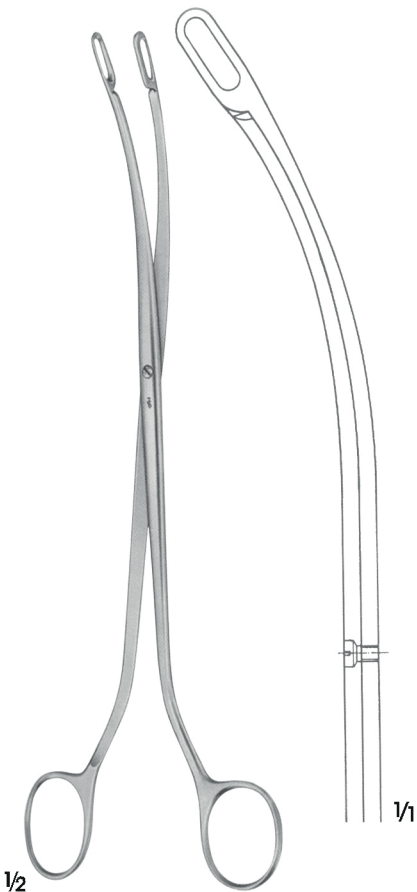

DESJARDINS
EE610-02-EE610-05
22.5 cm

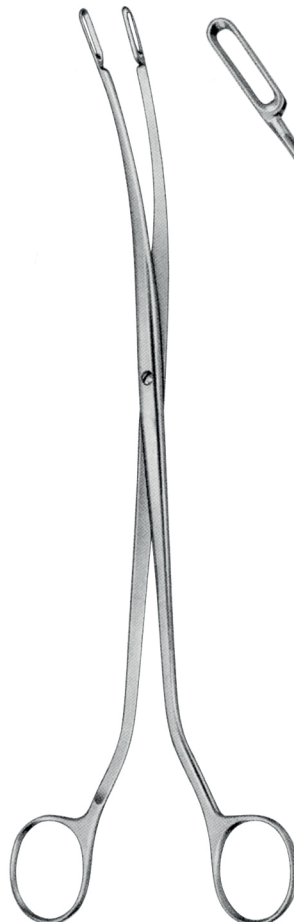

DESJARDINS
EE612-01-EE612-02
Hassas model
Extremely delicate patterns

1/2

1/2

